

Beta



2 0 2 3

Tarif

Valable jusqu'au 29/02/2024
Hors T.V.A.

R • PETER AG

BETA EST SYNONYME DE
AUDACE. ENGAGEMENT. HARMONIE. TALENT.



Chez Beta, il n'existe qu'une seule manière de faire les choses : les faire bien.

Le monde de Beta est guidé par le principe de labeur quotidien dans le monde entier, qui s'inspire de quatre valeurs :

L'AUDACE *d'investir et de rebooster constamment une entreprise créée par un artisan italien en 1923, qui s'est affirmée dans le monde et n'a cessé de croître depuis quatre générations.*

L'ENGAGEMENT *de peaufiner la qualité de nos produits jusque dans les moindres détails, car chaque revendeur sait qu'il peut compter sur un service efficace, et chaque utilisateur sur la précision, la fiabilité et la solidité des produits Beta.*

L'HARMONIE *des lignes pour un design d'excellence, car les choses bien faites expriment un équilibre parfait entre fonction et design.*

LE TALENT *notre plus grande ressource, celle qui distingue notre effectif et tous ceux qui choisissent Beta pour ne rien laisser au hasard, dans la réalisation passionnante de leurs idées et de leurs rêves.*



INDEX



	📖
Index.....	4
Guide de lecture.....	8
Champs d'utilisation clés dynamométriques	58-59
Tableau des servantes et compositions	341, 441-442
Articles supprimés = articles de remplacement/recommandés ..	684÷686
Index alphabétique	687÷692
Index alphabétique outils pour réparation automobile	693÷694
Index alphanumérique	695÷709
Numéros clés du Groupe Beta.....	710
L'histoire de l'outillage en Italie	711
Qualité certifiée	712
Contrôle et qualité.....	713
Logistique	714
Organiser le travail.....	715
Présence efficace	716



INDEX



Index.....	4
Guide de lecture.....	8
Champs d'utilisation clés dynamométriques	58-59
Tableau des servantes et compositions	341, 441-442
Articles supprimés = articles de remplacement/recommandés ..	684÷686
Index alphabétique	687÷692
Index alphabétique outils pour réparation automobile	693÷694
Index alphanumérique	695÷709
Numéros clés du Groupe Beta.....	710
L'histoire de l'outillage en Italie	711
Qualité certifiée	712
Contrôle et qualité.....	713
Logistique	714
Organiser le travail.....	715
Présence efficace	716

INDEX

AMEUBLEMENT DE L'ATELIER RSC55



RSC55

398÷422

AMEUBLEMENT DE L'ATELIER C45PRO



Beta
C45PRO

423÷440

MOBILIER D'ATELIER ET COMPOSITIONS D'OUTILS



341÷359

Beta
RSC



360÷370



371÷397

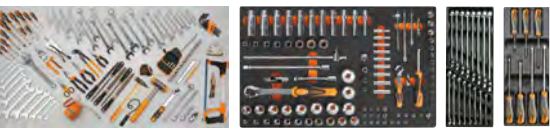

441÷520

CLÉS DE SERRAGE



11÷17

24÷27

111÷117

DOUILLES ET ACCESSOIRES



70÷78

85÷111

CLÉS DYNAMOMÉTRIQUES ET MULTIPLICATEURS



54÷56

57÷70

TOURNEVIS, CLÉS MÂLES ET EMBOUTS POUR VISSEUSES



18÷24

78÷85

115÷117

146÷159

PINCES ET PINCES COUPANTES



128÷132

140÷143

238

MARTELLERIE ET FRAPPE



9-10

166÷170

220

OUTILS POUR PERCER ET FILETER



36÷41

41÷44

44÷51

51÷53

ÉCLAIRAGE



243÷248

EXTRACTEURS



170-171

201÷205

ENROULEURS



248÷250; 337

OUTILS DE MESURAGE ET TRAÇAGE



213÷220

PLOMBERIE



27÷35

OUTILS DE COUPE ET D'ENTRETIEN DIVERS



123

133÷137

158-159

186



212

221÷230

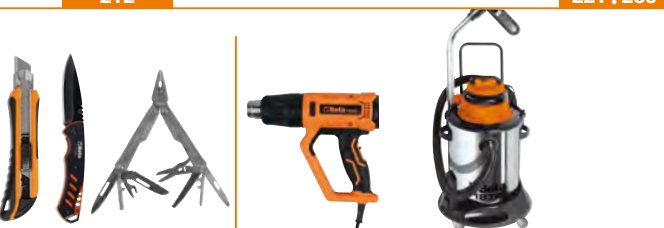

239÷242

250÷251

ÉLECTRONIQUE ET MICROMÉCANIQUE



126-127

143÷145

149÷151

MICROTECHNIQUE



137÷140

150

544÷546

234÷238

SOUDEURS



252÷256

OUTILS AVEC POIGNÉE CONFORT EN 1000V



287÷293

OUTILS EN ACIER INOXYDABLE



301÷305

OUTILS ANTIDÉFLAGRANTS



306÷314

RÉPARATION AUTOMOBILE



117÷126

160÷166



170÷201, 231÷233

234÷239

ÉQUIPEMENT D'ATELIER



256÷275

OUTILS POUR MOTOCYCLES



276÷281

OUTILS POUR VÉLOS



282÷286

OUTILS À BATTERIE



315÷317

OUTILLAGE PNEUMATIQUE ET ACCESSOIRES



318÷340

OUTILS ANTI-CHUTE



294÷300

CHEMICAL PRODUCTS



521÷526

CHAUSSURES DE SÉCURITÉ (ET CHAUSSETTES TECHNIQUES)



583÷611

ABRASIVE TOOLS



527÷543

WORKWEAR



612÷630

PRODUITS DE MARQUE BM : COLLIERS, BORNIER, RUBANS ISOLANTS



547÷553

GAMME BLISTER



554÷568

ACCESSOIRES POUR CÂBLES **ROBUR**

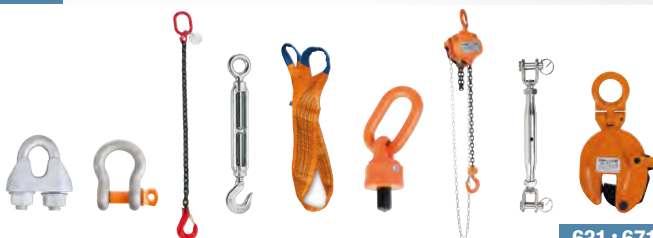

631÷671

SOLUTIONS POUR LE POINT DE VENTE



569÷582

BETA COLLECTION



672÷683

GUIDE DE LECTURE

référence de l'article

1048N

Pince multiprise entrepassée
branches gainées avec PVC antidérapant

empreinte de l'outil



prix

★ article disponible sur demande

• mesure principale

○ bouche hexagonale

ISO 8976

conditionnement

n.° of tools per box

L mm	A max mm	L1 mm	S mm	CHF		
175	36	31	11	34.50	3	010480910
250	46	38	13	36.50	5	010480915
300	60	44	14.8	54.50	2	010480920

confection blister



outils pour motos



outils pour vélos



code commande

1048N/D3

Jeu de pinces multiprise entrepassées
Tête phosphatée

nombre d'outils d'un jeu

présentation

contenu d'un jeu

1048N/D3	CHF		
-175-250-300 mm	126.00	1	010480923

nouveauté 2023

Interprétation des sigles les plus courants

Pour les jeux d'articles

Exemples	
B	= en trousse plastique
BV	= trousse vide
C	= en coffret tôle
D	= en emballage accrochable
S	= en boîte
SP	= sur présentoir
SPV	= présentoir vide
SC	= avec support compact
SCV	= support compact vide

Pour les compositions

AS	= avec des clés de dimensions en pouces
E	= version Électronique/Microtechnique
I	= version hydraulique
MT	= version engins de chantier
U	= version générale
SBK	= version Réparation Motos
VG	= version réparation automobile
VI	= version industrielle

Pour les douilles

A	= empreinte 6 pans
B	= empreinte 12 pans
ES	= empreinte 6 pans cannelés
FTX	= empreinte TORX®

Exemples

Interprétation des sigles les plus courants

PT	= vis en étoile à 5 pointes
X	= cliquet réversible en coffret

Pour les tournevis et embouts pour visseuses

LP	= pour vis à fente
PE	= pour vis 6 fente creux
PH	= pour vis à empreinte PHILLIPS®
PZ	= pour vis à empreinte POZIDRIV® - SUPADRIV®
RTX	= pour vis à empreinte TAMPER RESISTANT TORX®
SP	= pour vis à empreinte SPANNER
TRW	= pour vis à empreinte TRI-WING®
TQS	= pour vis à empreinte TORQ-SET®
TX	= pour vis à empreinte TORX®
XZN	= pour vis à empreinte XZN®

Génériques

AS	= dimensions en pouces
BA	= outillage anti-déflagrant
BM	= manche bi-matériaux
C	= coffret métallique vide
HS	= outils anti-chute
INOX	= outils en acier inoxydable
L	= série longue
MQ	= avec poignée confort en 1000V
MP	= finition polie chromée
R	= recharge

Les renseignements et photos figurant dans ce chapitre sont donnés à titre indicatifs et n'ont aucune valeur contractuelle. Beta Utensili se réserve le droit de mettre à jour ou d'accroître sa gamme de produits sans préavis, et sans obligation d'effectuer les modifications sur les modèles vendus antérieurement.



Beta VOUS RECOMMANDE d'utiliser l'outil adapté à la tâche que vous devez effectuer tout en respectant les normes de protection individuelle.



CHASSE-GOUPILLES

Les outils de frappe Beta ont été conçus pour offrir des performances optimales et assurer la sécurité de l'opérateur.

Un type spécial d'acier, qui contient du chrome, du molybdène et du vanadium (65CrMoV2-2) est utilisé pour la production, ce qui donne des outils remarquablement durs et résistants. Les produits sont fabriqués – si leur géométrie le permet – avec des barres étirées, dans le cas contraire ils sont forgés à chaud dans une atmosphère contrôlée, pour éviter la formation de scories.

- 1** Les chasses-goupilles possèdent des profils hexagonaux empêchant l'outil de rouler.
- 2** De plus ils sont équipés de pointes extrêmement longues mais parfaitement droites permettant l'accès dans les espaces exigus.
- 3** Afin de garantir une plus grande efficacité de nos chasses-goupilles, chaque pièce est emboutie individuellement afin que la partie cylindrique soit uniforme et que son extrémité soit parfaitement plate.
- 4** Toutes les faces sont soumises à une trempe par induction, pour éviter l'éclatement. La déformation du point de frappe est une conséquence naturelle afin que la sécurité de l'opérateur soit assurée.



Les poinçons affûtés après avoir été chromés, améliore les performances de gravure et de coupe et élimine le dépôt galvanique des pointes. Les bavures doivent être éliminés pour éviter « l'arrondi » des coins et la fragilité dus à la quantité d'hydrogène produite lors de la galvanoplastie. Les zones travaillées sont protégées par une couche antirouille.



30 Chasse-clous



Ø mm	L mm	CHF	📦	📄
2	125	9.25	10	000300020
3	125	9.25	10	000300030
4	150	12.30	10	000300040
5	150	12.30	10	000300050
6	150	12.90	10	000300060

31 Chasse-goupilles



Ø mm	L mm	L1 mm	CHF	📦	📄
2	110	22	9.25	10	000310002
3	128	35	9.55	10	000310003
4	146	45	11.70	10	000310004
5	164	55	12.30	10	000310005
6	182	65	15.50	5	000310006
8	200	80	16.40	5	000310008
10	220	95	20.60	5	000310010



	CHF	📦	📄
31/B6N 2-3-4-5-6-8 mm	86.00	1	000310024
2002/BV6	11.30	1	020020000
31/SP6 2-3-4-5-6-8 mm	91.50	1	000310030
31/SPV	24.70	1	000310031

31BM Chasse-goupilles gainé confort



Ø mm	L mm	L1 mm	CHF	📦	📄
2	168	42	19.00	2	000310402
3	180	52	19.50	2	000310403
4	191	62	21.20	2	000310404
5	200	72	22.30	2	000310405
6	221	82	25.50	2	000310406
8	235	94	27.00	2	000310408



	CHF	📦	📄
31BM/D6 2-3-4-5-6-8 mm	134.50	1	000310420

31L

Chasse-goupilles long



∅ mm	L mm	L1 mm	CHF	5	10
4	175	80	13.90	5	000310104
5	175	80	14.90	5	000310105
6	175	80	17.60	5	000310106

31SE

Chasse-goupilles pour goupilles élastiques



∅ mm	D mm	L mm	L1 mm	CHF	5	10
4	2,4	175	80	13.90	5	000310204
5	3,0	175	80	14.90	5	000310205
6	3,6	175	80	17.60	5	000310206



	CHF	1	10
31/B6N-LSE	104.00	1	000310324
31L: 4-5-6 mm			
31SE: 4-5-6 mm			
2002/BV6	11.30	1	020020000

32

Pointeau



∅ mm	L mm	L1 mm	CHF	10	20
3	100	44	8.55	10	000320100
4	125	52	10.60	10	000320125
5	150	62	12.90	10	000320150

32AU

Pointeau automatique

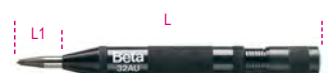

∅ mm	L mm	L1 mm	CHF	2	10
3	150	23	69.50	2	000320160

32AUR

Pointe pour 32AU



∅ mm	CHF	5	10
3	12.50	5	000320170

34

Burin plat



L mm	A mm	L1 mm	CHF	5	10
125	14,5	45	13.30	5	000340001
150	17,0	58	17.50	5	000340002
175	21,5	68	25.50	5	000340003

35

Burin nervuré



L mm	A mm	CHF	5	10
100	14,5	15.60	5	000350001
125	17,0	17.50	5	000350002
150	20,5	21.70	5	000350003
200	23,0	33.00	5	000350004
250	28,5	47.00	2	000350005
300	34,0	64.50	2	000350006

35PM

Burin nervuré avec protecteur



L mm	A mm	CHF	2	10
200	23,0	49.00	2	000350014
250	28,5	63.00	2	000350015
300	34,0	82.00	2	000350016

35PMR

Protecteur pour burin



L mm	CHF	1	10
200	16.40	1	000350024
250	16.40	1	000350025
300	17.20	1	000350026

36

Bédane



L mm	A mm	L1 mm	CHF	5	10
125	4	44	13.90	5	000360001
150	6	53	16.40	5	000360002

37

Bédane nervuré



L mm	A mm	L1 mm	CHF	5	10
150	6	45	25.00	5	000370001
200	8	55	36.00	3	000370002

37PM

Bédane nervuré avec protecteur



L mm	A mm	CHF	2	10
200	8	53.50	2	000370012

37PMR

Protecteur pour bédane



L mm	CHF	1	10
200	17.20	1	000370022



	CHF	1	10
38/B6N	87.50	1	000380016
30: 2-3 mm			
32: 4 mm			
34: 125-150 mm			
36: 150 mm			
2002/BV6	11.30	1	020020000
38/SP6	96.00	1	000380009
30: 2-3 mm			
32: 4 mm			
34: 125-150 mm			
36: 150 mm			
38/SPV	25.00	1	000380019

LA CLÉ ICONIQUE DE BETA

Notre clé historique 42 opte pour un nouveau design.

Une forme élégante, rehaussée d'un profil élancé, et plus agréable au toucher. La résistance, et la conception ergonomique de cette nouvelle clé Beta atteignent des niveaux d'excellence, afin de fournir aux utilisateurs le meilleur outil possible. Son processus de fabrication est effectué dans nos usines de Sovico et Sulmona, sur la base d'une technologie d'automatisation de pointe et d'ouvriers expérimentés.

FACILITE D'UTILISATION

Un angle de 15 degrés par rapport à l'axe, permet de réduire l'angle d'enroulement

RÉSISTANCE REMARQUABLE

en cas de mauvaise utilisation, la clé se déforme, sans se casser brutalement et dangereusement

HOMOGENEUS

Le pressage HOMOGENEUS est basé sur un produit semi-fini à section ronde, empêchant ainsi la formation de contraintes internes dangereuses.

ACCESSIBLE

Épaisseur réduite pour une meilleure accessibilité

PROTÉGÉ

Le placage nickel-chrome offre une résistance durable aux agents extérieurs et répond aux exigences strictes des tests d'adhérence selon ISO 2819

OPTIMISÉ

La clé, plus longue que la plupart des concurrents, permet d'obtenir des couples élevés grâce à un effort moindre.



ERGONOMIQUE

L'œil de la clé possède un angle de 15 degrés pour protéger la main.

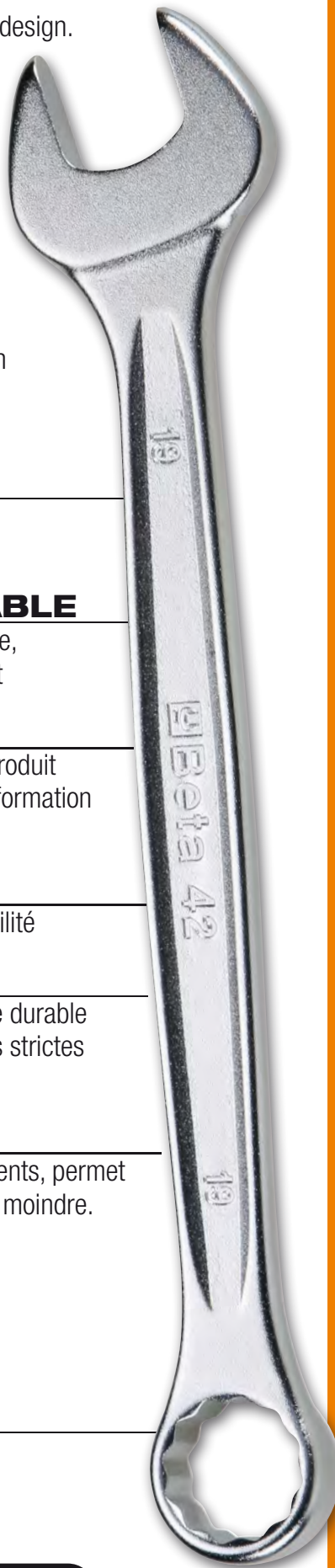

INFORMATION IMPORTANTE !

La forme de la nouvelle clé 42 est parfaitement compatible avec tous les supports et les modules de la clé historique 42.

42

Clé mixte

Valeurs de couple de serrage plus que doublées par rapport aux exigences de la norme ISO 1711



DIN 3113 UNH-ISO 7738

mm	L mm	S1 mm	CHF		
5,5x5,5	95	3,4	10.00	5	000421005
6x6	95	3,4	10.10	5	000421006
7x7	105	3,6	10.20	5	000421007
8x8	116	3,9	10.50	5	000421008
9x9	127	4,2	11.10	5	000421009
10x10	137	4,5	11.40	5	000421010
11x11	148	4,8	12.20	5	000421011
12x12	158	5,1	12.40	5	000421012
13x13	169	5,6	12.40	5	000421013
14x14	180	5,7	14.30	5	000421014
15x15	190	6,0	15.80	5	000421015
16x16	201	6,3	16.30	5	000421016
17x17	212	6,8	17.10	5	000421017
18x18	222	7,0	18.10	5	000421018
19x19	233	7,5	18.70	5	000421019
20x20	243	7,7	21.00	3	000421020
21x21	254	7,9	22.60	3	000421021
22x22	264	8,3	23.30	3	000421022
23x23	275	8,5	25.00	3	000421023
24x24	285	8,7	26.50	3	000421024
25x25	296	8,7	28.00	2	000421025
26x26	307	8,9	30.00	2	000421026
27x27	317	9,1	33.00	2	000421027
28x28	328	9,3	33.50	2	000421028
29x29	338	9,5	37.00	2	000421029
30x30	349	9,7	38.50	2	000421030
32x32	370	10,1	42.00	2	000421032
34x34	391	10,5	80.50	1	000421034
35x35	412	10,7	87.00	1	000421035
36x36	412	10,7	90.50	1	000421036
38x38	433	11,3	100.00	1	000421038
41x41	465	12,0	111.00	1	000421041



	CHF		
42/B9N 6-7-8-10-11-13-14-17-19 mm	131.50	1	000421074
2002/BV9	14.40	1	020020030



	CHF		
42/S14 6-7-8-10-11-12-13-14 -15-16-17-19-22-24 mm	211.00	1	000421067
42/S17 6-7-8-9-10-11-12-13-14-15 16-17-18-19-20-21-22 mm	257.00	1	000421065
42/S15 6-7-8-10-11-12-13-14 17-19-22-24-27-30-32 mm	293.00	1	000421066
42/S17X 6-7-8-10-11-12-13-14- 15-16-17-19-21-22- 24-27-30 mm	305.00	1	000421068
42/S26 6-7-8-9-10-11-12-13-14 15-16-17-18-19-20-21 22-23-24-25-26-27-28 29-30-32 mm	552.00	1	000421070

Jeu de 9 clés mixtes avec support compact

Valeurs de couple de serrage plus que doublés par rapport aux exigences de la norme ISO 1711



	CHF	🔧	📦
42/SC9I	135.00	1	000421087
8-10-11-12-13-14-15-17-19 mm			
142/SCV9I	13.00	1	001420103
42/SC9E	139.50	1	000421088
8-10-11-12-13-16-17-18-19 mm			
142/SCV9E	13.00	1	001420104



	CHF	🔧	📦
42/SP25	582.00	1	000421085
6-7-8-9-10-11-12-13-14 15-16-17-18-19-20-21 22-23-24-25-26-27-28 30-32 mm			
42/SPV2	67.00	1	000420090



42/SP15

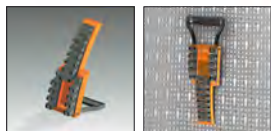

42/SPV...

	CHF	🔧	📦
42/SP15	230.00	1	000421078
6-7-8-9-10-11-12-13-14-15 16-17-19-22-24 mm			
42/SPV7	9.25	1	000420097
42: 8-10-11-13-14-17-19 mm			
55: 6x7-8x9-10x11-12x13 14x15-16x17-18x19 mm			
42/SPV11	13.00	1	000420100
42MP: 8-9-10-11-12-13 14-15-16-17-19 mm			
142-142SN: 8-9-10-11-12-13 14-15-16-17-19 mm			
42/SPV15	17.60	1	000420102
42: 6-7-8-9-10-11-12-13-14 15-16-17-19-22-24 mm			

42AS Clé mixte



🔧	L mm	CHF	🔧	📦
1/4x1/4	95	12.50	2	000420106
9/32x9/32	106	12.70	2	000420107
5/16x5/16	116	12.80	2	000420108
3/8x3/8	137	14.10	2	000420110
7/16x7/16	148	15.10	2	000420111
1/2x1/2	169	15.60	2	000420113
9/16x9/16	180	17.00	2	000420114
19/32x19/32	191	18.60	2	000420115
5/8x5/8	201	19.70	2	000420116
11/16x11/16	212	21.10	2	000420117
3/4x3/4	233	22.50	2	000420119
13/16x13/16	254	27.00	2	000420121
7/8x7/8	264	28.00	2	000420122
15/16x15/16	285	33.00	2	000420124
1x1	296	33.50	2	000420125
1.1/16x1.1/16	317	38.50	2	000420127
1.1/8x1.1/8	338	41.50	2	000420129
1.1/4x1.1/4	370	51.00	2	000420132
1.5/16x1.5/16	391	83.00	1	000420133
1.3/8x1.3/8	412	95.50	1	000420135
1.7/16x1.7/16	412	98.50	1	000420136
1.1/2x1.1/2	433	103.50	1	000420138



	CHF	🔧	📦
42AS/B9N	165.00	1	000420159
1/4-5/16-3/8-7/16-1/2 9/16-5/8-11/16-3/4			
2002/BV9	14.40	1	020020030



	CHF	🔧	📦
42AS/13	272.00	1	000420163
1/4-5/16-3/8-7/16-1/2-9/16-5/8 11/16-3/4-13/16-7/8-15/16-1			
42AS/16	403.00	1	000420166
1/4-5/16-3/8-7/16-1/2-9/16-5/8 11/16-3/4-13/16-7/8-15/16-1- 1.1/16-1.1/8-1.1/4			
42AS/17	383.00	1	000420168
1/4-9/32-5/16-3/8-7/16-1/2- 9/16-19/32-5/8-11/16-3/4- 13/16-7/8-15/16-1-1.1/16-1.1/8			



42MP Clé mixte polie chromée



DIN 3113 UNI-ISO 7738

🔧	L mm	CHF	🔧	📦
6x6	95	17.10	5	000420606
7x7	105	17.20	5	000420607
8x8	116	17.40	5	000420608
9x9	127	17.50	5	000420609
10x10	137	17.60	5	000420610
11x11	148	18.00	5	000420611
12x12	158	18.10	5	000420612
13x13	169	18.40	5	000420613
14x14	180	19.80	5	000420614
15x15	190	21.50	5	000420615
16x16	201	22.70	5	000420616
17x17	212	23.70	5	000420617
18x18	222	25.50	5	000420618
19x19	233	26.00	5	000420619
20x20	243	30.00	3	000420620
21x21	254	31.50	3	000420621
22x22	264	32.00	3	000420622
24x24	285	37.00	3	000420624
27x27	317	44.00	3	000420627
30x30	349	54.50	3	000420630
32x32	370	57.00	3	000420632



	CHF	🔧	📦
42MP/B9N	189.50	1	000420661
6-7-8-10-11-13-14-17-19 mm			
2002/BV9	14.40	1	020020030



	CHF	🔧	📦
42MP/S17	374.00	1	000420652
6-7-8-9-10-11-12-13-14-15 16-17-18-19-20-21-22 mm			
42MP/S21	567.00	1	000420653
6-7-8-9-10-11-12-13-14 15-16-17-18-19-20-21-22 24-27-30-32 mm			

42LMP

Clé mixte longue polie chromée



mm	L mm	CHF		
8x8	148	16.40	2	000420508
9x9	167	16.90	2	000420509
10x10	172	17.50	2	000420510
11x11	186	18.40	2	000420511
12x12	197	18.70	2	000420512
13x13	207	19.10	2	000420513
14x14	223	20.30	2	000420514
15x15	233	22.30	2	000420515
16x16	243	24.10	2	000420516
17x17	261	25.50	2	000420517
18x18	270	28.00	2	000420518
19x19	280	28.50	2	000420519
21x21	301	33.00	2	000420521
22x22	318	34.00	2	000420522
24x24	338	39.50	2	000420524
27x27	376	45.00	2	000420527
30x30	409	57.50	2	000420530
32x32	435	62.50	2	000420532



42LMP/S14 CHF 322.00 1 000420551

8-9-10-11-12-13-14
15-16-17-18-19-21-22 mm

42LMP/S18 CHF 527.00 1 000420552

8-9-10-11-12-13-14
15-16-17-18-19-21-22
24-27-30-32 mm

42SLIM

Clé mixte à tête slim affinée



DIN 3113 UNI-ISO 7738

mm	L mm	S1 mm	CHF		
8x8	116	3,4	11.50	5	000420408
10x10	137	3,8	12.50	5	000420410
11x11	148	3,8	13.30	5	000420411
12x12	158	4,2	13.50	5	000420412
13x13	169	4,4	13.60	5	000420413
14x14	180	4,6	15.60	5	000420414
15x15	190	4,7	17.00	5	000420415
16x16	201	4,7	17.60	5	000420416
17x17	212	5,1	18.20	5	000420417
18x18	222	5,1	19.60	5	000420418
19x19	233	5,6	20.00	5	000420419



42SLIM/B8NI CHF 138.00 1 000420478

10-11-12-13-14-15-17-19 mm

42SLIM/B8NE CHF 142.50 1 000420479

10-11-12-13-16-17-18-19 mm

2002/BV8 CHF 14.40 1 020020020



42SLIM/S11 CHF 172.50 1 000420471

8-10-11-12-13-14-15-
16-17-18-19 mm

45

Clé mixte série lourde



DIN 3113 UNI-ISO 7738

mm	L mm	CHF		
46x46	500	238.00	1	000450046
50x50	540	268.00	1	000450050
55x55	560	383.00	1	000450055
60x60	600	491.00	1	000450060
65x65	675	589.00	1	000450065
70x70	675	645.00	1	000450070
75x75	720	751.00	1	000450075
80x80	720	867.00	1	000450080

52

Clé à fourche



UNI 6733 DIN 3114

mm	L mm	CHF		
10	119	12.50	5	000520010
11	119	12.80	5	000520011
12	119	13.20	5	000520012
13	145	14.90	5	000520013
14	145	15.30	5	000520014
15	145	15.60	5	000520015
16	159	16.90	5	000520016
17	159	17.00	5	000520017
18	159	18.10	5	000520018
19	175	19.70	5	000520019
20	175	21.10	5	000520020
21	175	21.70	5	000520021
22	196	24.40	2	000520022
23	196	25.00	2	000520023
24	196	25.50	2	000520024
25	215	29.00	2	000520025
26	215	29.50	2	000520026
27	215	29.50	2	000520027
28	240	34.00	2	000520028
30	240	34.50	2	000520030
32	270	41.50	2	000520032
34	270	45.00	1	000520034
35	295	52.00	1	000520035
36	295	52.00	1	000520036
38	295	58.00	1	000520038
40	335	71.50	1	000520040
41	335	71.50	1	000520041
42	335	79.50	1	000520042
45	370	91.00	1	000520045
46	370	91.00	1	000520046
48	370	105.50	1	000520048
50	415	122.50	1	000520050
52	415	137.50	1	000520052
55	415	142.50	1	000520055
60	490	181.00	1	000520060
65	490	184.00	1	000520065
70	490	208.50	1	000520070

53

Clé à fourche gros effort DIN 894



mm	L mm	CHF		
36	317	38.50	1	000530036
38	320	42.00	1	000530038
41	342	49.50	1	000530041
46	396	60.00	1	000530046
50	412	94.00	1	000530050
55	457	108.00	1	000530055
60	492	133.50	1	000530060
65	528	158.00	1	000530065
70	572	183.00	1	000530070
75	608	229.50	1	000530075
80	645	281.00	1	000530080
85	690	341.00	1	000530085
90	690	404.00	1	000530090
95	847	564.00	1	000530095
100	847	596.00	1	000530100
105	1000	744.00	1	000530105
110	1000	805.00	1	000530110
115	1000	898.00	1	000530115
120	1000	1,018.00	1	000530120
125	1000	1,176.00	1	000530125
130	1000	1,260.00	1	000530130
135	1000	1,350.00	1	000530135

55

Clé à fourches



UNI-ISO 10102 DIN 3110

mm	L mm	CHF		
4x5	101	7.40	5	000550003
5x5,5	101	8.35	5	000550006
5,5x7	120	8.35	5	000550009
6x7	120	6.60	5	000550012
7x8	140	8.35	5	000550018
8x9	140	6.70	5	000550021
8x10	140	8.35	5	000550024
10x11	155	7.05	5	000550030
10x12	155	9.60	5	000550033
10x13	170	10.50	5	000550035
12x13	170	8.00	5	000550042
12x14	170	10.80	5	000550045
13x14	185	12.10	5	000550047
13x17	189	12.90	5	000550051
14x15	185	10.10	5	000550054
14x17	189	13.90	5	000550057
16x17	202	11.50	5	000550060
17x19	220	15.50	2	000550063
18x19	220	13.60	2	000550066
19x22	236	17.60	2	000550069
20x22	236	15.50	2	000550075
21x23	245	16.50	2	000550078
22x24	245	19.10	2	000550081
24x26	262	19.60	2	000550087
24x27	262	21.30	2	000550090
25x28	272	22.30	2	000550096
27x29	284	25.50	2	000550099
27x30	284	29.00	2	000550102
27x32	297	31.50	2	000550105
30x32	297	28.00	2	000550108
32x36	325	86.00	1	000550114
34x36	325	86.00	1	000550117
35x38	375	95.50	1	000550120
36x41	375	100.00	1	000550123
41x46	425	114.00	1	000550129
46x50	475	141.50	1	000550132
50x55	500	164.50	1	000550135
55x60	500	173.50	1	000550138



55/B8N	CHF 93.50	1	000550160
6x7-8x9-10x11-12x13 14x15-16x17-18x19 20x22 mm			
2002/BV8	14.40	1	020020020
55/B12N	189.00	1	000550164
6x7-8x9-10x11-12x13 14x15-16x17-18x19 20x22-21x23-24x26 25x28-30x32 mm			
2002/BV12	23.90	1	020020040



55/S8	CHF 78.50	1	000550174
6x7-8x9-10x11-12x13 14x15-16x17-18x19 20x22 mm			
55/S12	165.50	1	000550178
6x7-8x9-10x11-12x13 14x15-16x17-18x19 20x22-21x23-24x26 25x28-30x32 mm			
55/S12X	167.50	1	000550179
6x7-8x9-10x11-12x13 14x15-16x17-18x19 20x22-21x23-24x27 25x28-30x32 mm			
55/S13	191.00	1	000550182
6x7-8x9-10x11-12x13 14x15-16x17-18x19 20x22-21x23-24x26 25x28-27x29-30x32 mm			



55/SP7	CHF 67.00	1	000550167
6x7-8x9-10x11-12x13 14x15-16x17-18x19 mm			
42/SPV7	9.25	1	000420097
42: 8-10-11-13-14-17-19 mm 55: 6x7-8x9-10x11-12x13 14x15-16x17-18x19 mm			
55/SP13	237.00	1	000550186
6x7-8x9-10x11-12x13 14x15-16x17-18x19 20x22-21x23-24x26 25x28-27x29-30x32 mm			
55/SPV	46.00	1	000550190

55AS Clé à fourches



mm	L mm	CHF	1	2
1/4x9/32	120	8.80	2	000550203
1/4x5/16	120	8.80	2	000550206
5/16x11/32	140	9.50	2	000550209
5/16x3/8	140	9.50	2	000550212
3/8x7/16	155	10.20	2	000550215
7/16x1/2	170	11.30	2	000550218
1/2x9/16	170	12.10	2	000550221
9/16x5/8	185	13.30	2	000550224
19/32x11/16	189	16.30	2	000550227
5/8x11/16	202	16.30	2	000550230
5/8x3/4	202	18.20	2	000550233
11/16x13/16	220	19.00	2	000550242
3/4x7/8	236	20.50	2	000550245
25/32x13/16	236	20.50	2	000550244
7/8x15/16	245	22.10	2	000550251
15/16x1	262	28.00	1	000550257
1x1.1/8	272	29.50	1	000550259
1.1/16x1.1/4	284	38.50	1	000550267
1.1/8x1.5/16	297	38.50	1	000550266
1.5/16x1.1/2	325	101.50	1	000550269
1.3/8x1.1/2	375	112.00	1	000550272
1.7/16x1.5/8	375	112.00	1	000550275



55AS/5	CHF 68.00	1	000550290
5/16x11/32-3/8x7/16 1/2x9/16-5/8x11/16 3/4x7/8			
55AS/8	109.50	1	000550296
1/4x9/32-5/16x11/32-3/8x7/16- 1/2x9/16-9/16x5/8-5/8x11/16- 11/16x13/16-3/4x7/8			
55AS/12	225.50	1	000550298
1/4x9/32-5/16x11/32-3/8x7/16-1 1/2x9/16-9/16x5/8-5/8x11/16- 11/16x13/16-25/32x13/16-3/4x7/8- 15/16x1-1x1.1/8-1.1/16x1.1/4			

55MP Clé à fourches polie chromée



UNI-ISO 10102 DIN 3110

mm	L mm	CHF	1	2
6x7	120	8.75	2	000550603
8x9	140	9.35	2	000550606
10x11	155	10.40	2	000550609
12x13	170	11.40	2	000550612
14x15	185	13.50	2	000550615
16x17	202	15.90	2	000550618
18x19	220	18.40	2	000550621
20x22	236	21.10	2	000550624
21x23	245	22.90	2	000550627
24x26	262	27.50	1	000550630
25x28	272	29.00	1	000550633
27x29	284	33.50	1	000550636
30x32	297	38.00	1	000550639

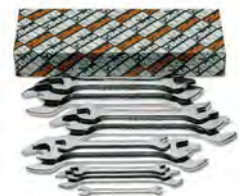

55MP/S8	CHF 108.50	1	000550650
6x7-8x9-10x11-12x13 14x15-16x17-18x19 20x22 mm			
55MP/S13	259.00	1	000550651
6x7-8x9-10x11-12x13 14x15-16x17-18x19 20x22-21x23-24x26 25x28-27x29-30x32 mm			
55MP/S12	225.50	1	000550653
6x7-8x9-10x11-12x13-14x15- 16x17-18x19-20x22-21x23-24x26- 25x28-30x32 mm			

58 Clé à fourche à frapper



DIN 133

mm	L mm	CHF	1	2
24	177	39.50	1	000580024
27	180	41.50	1	000580027
30	190	46.00	1	000580030
32	190	47.50	1	000580032
34	200	60.00	1	000580034
36	215	62.00	1	000580036
41	235	73.50	1	000580041
46	255	98.50	1	000580046
50	275	110.50	1	000580050
55	300	132.50	1	000580055
60	320	145.00	1	000580060
65	342	190.50	1	000580065
70	375	245.50	1	000580070
75	375	268.00	1	000580075
80	408	392.00	1	000580080
85	408	439.00	1	000580085
90	445	506.00	1	000580090
95	445	521.00	1	000580095
100	485	720.00	1	000580100
105	485	813.00	1	000580105
110	510	890.00	1	000580110
115	510	1,014.00	1	000580115
120	545	1,045.00	1	000580120
125	545	1,197.00	1	000580125
130	575	1,620.00	1	000580130
135	575	1,700.00	1	000580135
*140	575	1,840.00	1	000580140
*145	640	2,520.00	1	000580145
*150	640	2,620.00	1	000580150
*155	640	2,870.00	1	000580155
*160	640	3,150.00	1	000580160
*165	715	3,370.00	1	000580165
*170	715	4,600.00	1	000580170
*175	715	4,860.00	1	000580175
*180	715	5,270.00	1	000580180
*185	715	5,420.00	1	000580185
*190	800	5,950.00	1	000580190
*195	800	6,250.00	1	000580195
*200	800	6,550.00	1	000580200
*210	800	8,170.00	1	000580210
*220	800	10,540.00	1	000580220
*230	800	12,870.00	1	000580230

78

Clé à fourches micromécanique



UNI 6737

mm	L mm	CHF		
4x4	78	11.00	5	000730040
4,5x4,5	78	11.00	5	000730045
5x5	78	11.00	5	000730050
5,5x5,5	86	12.00	5	000730055
6x6	86	12.00	5	000730060
7x7	86	12.00	5	000730070
8x8	97	12.50	5	000730080
9x9	97	12.50	5	000730090
10x10	108	13.50	5	000730100
11x11	108	13.50	5	000730110
12x12	124	15.60	5	000730120
13x13	124	15.60	5	000730130
14x14	124	15.60	5	000730140



	CHF		
73/B13N 4-4,5-5-5,5-6-7-8-9 10-11-12-13-14 mm	182.00	1	000730202
2002/BV13	14.40	1	020020050



	CHF		
73/S13 4-4,5-5-5,5-6-7-8-9 10-11-12-13-14 mm	168.00	1	000730210

78

Clé polygonale à frapper



DIN 7444

mm	L mm	CHF		
24	162	40.50	1	000780024
27	180	47.00	1	000780027
30	190	56.00	1	000780030
32	190	59.50	1	000780032
34	200	68.00	1	000780034
36	205	73.50	1	000780036
41	225	95.50	1	000780041
46	235	106.50	1	000780046
50	250	126.50	1	000780050
55	265	144.50	1	000780055
60	275	176.00	1	000780060
65	295	222.50	1	000780065
70	325	224.00	1	000780070
75	325	265.00	1	000780075
80	350	407.00	1	000780080
85	350	445.00	1	000780085
90	390	544.00	1	000780090
95	390	630.00	1	000780095
100	420	697.00	1	000780100
105	420	822.00	1	000780105
110	450	898.00	1	000780110
115	450	1,022.00	1	000780115
120	490	1,405.00	1	000780120
125	480	1,895.00	1	000780125
130	520	2,190.00	1	000780130
135	520	2,345.00	1	000780135
*140	520	2,670.00	1	000780140
*145	580	3,360.00	1	000780145
*150	580	3,520.00	1	000780150
*155	580	4,050.00	1	000780155
*160	650	4,150.00	1	000780160
*165	650	4,410.00	1	000780165
*170	650	5,290.00	1	000780170
*175	650	5,730.00	1	000780175
*180	650	6,290.00	1	000780180
*185	695	6,490.00	1	000780185
*190	695	7,090.00	1	000780190
*195	695	7,110.00	1	000780195
*200	695	7,200.00	1	000780200
*210	740	7,690.00	1	000780210
*215	740	8,610.00	1	000780215
*220	740	9,490.00	1	000780220
*230	740	11,760.00	1	000780230

78AS

Clé polygonale à frapper



mm	L mm	CHF		
*1.1/16	180	57.00	1	000780327
*1.1/8	190	57.00	1	000780329
*1.3/16	190	57.00	1	000780330
*1.1/4	197	62.00	1	000780332
*1.5/16	197	64.00	1	000780333
*1.3/8	223	68.00	1	000780335
*1.7/16	223	82.50	1	000780336
*1.1/2	223	85.00	1	000780338
*1.5/8	223	96.50	1	000780341
*1.11/16	225	101.00	1	000780343
*1.13/16	240	111.50	1	000780346
*1.7/8	250	113.00	1	000780348
*2	250	129.00	1	000780350
*2.1/16	250	133.50	1	000780352
*2.3/16	275	140.50	1	000780355
*2.3/8	270	190.50	1	000780360
*2.9/16	302	211.00	1	000780365
*2.3/4	350	229.50	1	000780370
*2.15/16	350	265.00	1	000780375
*3.1/8	354	438.00	1	000780380

80

Clé à douilles articulées



mm	L mm	CHF		
6x7	170	44.50	3	000800006
8x9	176	46.00	3	000800008
8x10	179	46.00	3	000800009
10x11	182	48.50	3	000800010
12x13	228	55.00	3	000800012
14x15	232	56.00	3	000800014
13x17	231	59.50	3	000800015
16x17	234	59.50	2	000800016
18x19	285	73.50	2	000800018
19x22	287	77.50	2	000800019
20x22	289	77.50	2	000800020
21x23	289	78.50	2	000800021
24x27	405	129.00	2	000800024
30x32	413	137.00	2	000800030

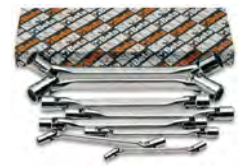

	CHF		
80/S8 6x7-8x9-10x11-12x13-14x15 16x17-18x19-20x22 mm	460.00	1	000800051
80/S11 6x7-8x9-10x11-12x13 14x15-16x17-18x19-20x22 21x23-24x27-30x32 mm	805.00	1	000800056

83

Clé polygonale demi-lune



ISO 3318

mm	L mm	CHF		
8x10	126	22.30	3	000830008
10x12	137	23.40	3	000830010
11x13	138	24.10	3	000830011
14x17	183	30.00	3	000830014
15x17	184	34.00	2	000830015
16x18	196	37.00	2	000830016
19x22	231	47.50	2	000830019



	CHF		
83/S3 11x13-14x17-19x22 mm	102.50	1	000830081
83/S5 10x12-11x13-15x17 16x18-19x22 mm	166.50	1	000830085

83AS

Clé polygonale demi-lune



mm	L mm	CHF	U	IT
7/16x1/2	138	28.50	2	000830111
9/16x5/8	183	34.00	2	000830114
3/4x7/8	230	54.00	2	000830119



		CHF	U	IT
83AS/3		116.50	1	000830181
7/16x1/2-9/16x5/8 3/4x7/8				

88

Clé polygonale double droite, modèle extra-long



mm	L mm	CHF	U	IT
8x10	235	25.50	2	000880008
12x14	330	30.00	2	000880012
13x15	330	30.00	2	000880013
16x18	405	41.50	2	000880016
17x19	405	41.50	2	000880017
21x23	435	47.50	2	000880021
22x24	435	47.50	2	000880022



		CHF	U	IT
88/S7		263.00	1	000880107
8x10-12x14-13x15-16x18- 17x19-21x23-22x24 mm				

90

Clé polygonale contre-coudée



DIN 838 ISO 10104

mm	L mm	CHF	U	IT
6x7	165	12.50	5	000900006
8x9	180	13.40	5	000900012
8x10	180	15.80	5	000900015
10x11	195	14.80	5	000900018
10x12	195	16.00	5	000900021
11x13	215	17.60	5	000900024
12x13	215	16.10	5	000900027
12x14	215	18.50	5	000900030
14x15	230	17.60	5	000900033
14x17	250	21.80	5	000900036
16x17	250	20.10	5	000900039
17x19	265	26.00	5	000900042
18x19	265	23.40	5	000900045
19x22	285	29.00	3	000900048
20x22	285	27.00	3	000900051
21x23	305	30.50	2	000900057
22x24	305	33.00	2	000900060
24x26	325	34.00	2	000900063
24x27	325	38.00	2	000900067
25x28	340	41.00	2	000900070
27x29	355	44.00	2	000900073
27x30	355	47.50	2	000900076
27x32	375	53.50	2	000900078
30x32	375	49.50	2	000900080
32x36	395	73.50	1	000900088
34x36	415	87.50	1	000900089
35x38	415	88.50	1	000900091
36x41	435	101.00	1	000900094
41x46	460	145.00	1	000900097
46x50	500	191.50	1	000900100



		CHF	U	IT
90/B8N		159.50	1	000900156
6x7-8x9-10x11-12x13 14x15-16x17-18x19 20x22 mm				
2002/BV8		14.40	1	020020020



		CHF	U	IT
90/S8		145.00	1	000900162
6x7-8x9-10x11-12x13 14x15-16x17-18x19 20x22 mm				
90/S12		300.00	1	000900166
6x7-8x9-10x11-12x13 14x15-16x17-18x19 20x22-21x23-24x26 25x28-30x32 mm				
90/S12X		304.00	1	000900167
6x7-8x9-10x11-12x13 14x15-16x17-18x19 20x22-21x23-24x27 25x28-30x32 mm				
90/S13		343.00	1	000900170
6x7-8x9-10x11-12x13 14x15-16x17-18x19 20x22-21x23-24x26 25x28-27x29-30x32 mm				



		CHF	U	IT
90/SP13		389.00	1	000900174
6x7-8x9-10x11-12x13 14x15-16x17-18x19 20x22-21x23-24x26 25x28-27x29-30x32 mm				
55/SPV		46.00	1	000550190

90AS

Clé polygonale contre-coudée



mm	L mm	CHF	U	IT
1/4x5/16	165	14.40	2	000900203
5/16x11/32	180	15.50	2	000900206
5/16x3/8	180	15.90	2	000900209
3/8x7/16	195	16.10	2	000900212
7/16x1/2	215	18.10	2	000900215
1/2x9/16	230	20.70	2	000900218
9/16x5/8	230	20.70	2	000900221
19/32x11/16	250	22.60	2	000900222
5/8x11/16	250	23.40	2	000900224
5/8x3/4	265	27.50	2	000900227
11/16x3/4	265	27.50	1	000900230
11/16x13/16	265	27.50	1	000900233
3/4x25/32	265	32.00	1	000900235
3/4x7/8	285	32.00	1	000900237
13/16x7/8	285	33.00	1	000900240
7/8x15/16	305	33.00	1	000900243
15/16x1	325	39.50	1	000900252
1.1/16x1.1/4	375	57.00	1	000900258
1.1/8x1.5/16	375	57.50	1	000900261



		CHF	U	IT
90AS/8		190.50	1	000900298
1/4x5/16-5/16x11/32 3/8x7/16-1/2x9/16 5/8x11/16-11/16x3/4 13/16x7/8-15/16x1				
90AS/10		305.00	1	000900300
1/4x5/16-5/16x11/32 3/8x7/16-1/2x9/16 5/8x11/16-11/16x3/4 13/16x7/8-15/16x1 1.1/16x1.1/4-1.1/8x1.5/16				

91

Clé polygonale contre-coudée
gros effort

mm	Ø mm	CHF		
24	38	72.00	1	000910024
27	41	74.50	1	000910027
30	48	80.00	1	000910030
32	49	86.00	1	000910032
36	54	98.50	1	000910036
41	62	117.00	1	000910041
46	69	137.00	1	000910046
50	76	156.00	1	000910050
55	81	175.00	1	000910055
60	90	218.00	1	000910060
65	98	244.00	1	000910065
70	105	275.00	1	000910070
75	110	315.00	1	000910075
80	125	361.00	1	000910080
85	125	377.00	1	000910085
90	140	675.00	1	000910090
95	140	738.00	1	000910095
100	143	782.00	1	000910100
105	146	874.00	1	000910105

92

Manche tubulaire pour 91



	L mm	91 mm	Ø mm	CHF		
92/1	460	24÷30	19	43.50	1	000920010
92/2	610	32÷41	22	66.50	1	000920020
92/3	760	46÷55	25	94.00	1	000920030
92/4	860	60÷105	30	125.00	1	000920040

93

Clé polygonale pour échafaudage



mm	L mm	CHF		
21x22	310	51.50	3	000930021

93C

Clé à cliquet polygonale pour échafaudage



mm	L mm	CHF		
17x19	310	58.00	1	000930117
19x22	310	62.50	1	000930119
19x24	310	77.00	1	000930120
21x22	365	70.00	1	000930121
36x38	445	118.00	1	000930136

94

Clé à tuyauter



DIN 3118

mm	L mm	CHF		
8x10	140	21.80	2	000940008
9x11	153	22.70	2	000940009
10x11	153	23.90	2	000940010
11x13	175	24.70	2	000940011
12x14	175	26.00	2	000940012
13x15	175	26.00	2	000940013
14x15	175	30.50	2	000940014
14x17	195	31.50	2	000940015
17x19	212	32.00	2	000940017
19x22	228	34.00	2	000940019
22x24	242	42.00	2	000940022
24x27	260	46.00	2	000940024
30x32	300	59.50	2	000940030
36x41	320	101.50	1	000940036



	CHF		
94/S6	163.00	1	000940050

8x10-10x11-11x13-12x14
17x19-19x22 mm

	CHF		
94/S10	334.00	1	000940052

8x10-9x11-10x11-11x13
12x14-17x19-19x22
22x24-24x27-30x32 mm

95

Clé polygonale double droite



DIN 837 ISO 10103

mm	L mm	CHF		
6x7	120	14.30	3	000950161
8x9	135	15.40	3	000950162
10x11	150	17.40	3	000950163
12x13	165	18.90	3	000950164
14x15	185	19.80	3	000950165
16x17	210	21.10	3	000950166
17x19	225	24.40	3	000950167
18x19	225	24.40	2	000950168
20x22	240	27.50	2	000950169
21x23	255	29.00	2	000950170
24x26	270	30.50	2	000950171
25x28	285	37.00	2	000950172
27x29	315	38.00	2	000950173
30x32	335	42.50	2	000950174



	CHF		
95/S8	158.50	1	000950177

6x7-8x9-10x11-12x13
14x15-16x17-18x19
20x22 mm

	CHF		
95/S13	336.00	1	000950179

6x7-8x9-10x11-12x13
14x15-16x17-18x19
20x22-21x23-24x26
25x28-27x29-30x32 mm

95FTX

Clé double droite pour écrous TORX®



	L mm	CHF		
E6xE8	115	14.80	2	000950306
E10xE12	143	15.50	2	000950310
E14xE18	177	17.60	2	000950314
E20xE24	224	23.90	2	000950320



	CHF		
95FTX/S4	72.00	1	000950325

E6xE8-E10xE12
E14xE18-E20xE24

CLÉS 6 PANS COUDÉES

Les clés 6 pans coudées Beta ont été conçues pour une durée de vie longue et une utilisation précise. La large gamme couvre toutes les utilisations : les clés sphériques, courtes, longues, extra-longues et en T avec poignées haute performance fait partie des produits incontournables de Beta et sont inégalées sur le marché.

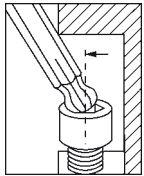

Les clés 6 pans coudées à tête sphérique permettent de travailler avec un angle maximum de 30° par rapport à l'axe de la vis.

Les clés sont emballées dans râtelier pour permettre une identification rapide de la taille requise. Lorsqu'il est fermé, il empêche les clés, même les plus petites, de sortir accidentellement.

La version Color combine les caractéristiques exceptionnelles des clés standard avec l'identification immédiate par couleur de la taille requise afin de faciliter le travail quotidien.



	CHF		
96/B8 2-2,5-3-4-5-6-8-10 mm	22.70	5	000960386
96/B10 1,5-2-2,5-3-4-5-6-8-10-12 mm	32.00	5	000960380
96N/BV	2.47	1	000960651



	CHF		
96/SC9 1,5-2-2,5-3-4-5-6-8-10 mm	27.00	1	000960374
96/SCV	5.50	1	000960985



	CHF		
96/SC12 2-2,5-3-3,5-4-4,5-5-6-7-8-9-10 mm	38.50	1	000960395
96/SCV12	6.60	1	000960975

96

Clé mâle 6 pans coudée, chromée



ISO 2936

mm	L mm	L1 mm	CHF		
0,9	35	8	1.27	20	000960013
1,3	39	10	1.27	20	000960014
1,5	45	15	1.27	20	000960015
2	50	17	1.34	20	000960020
2,5	57	20	1.34	20	000960025
3	64	22	1.58	20	000960030
3,5	68	25	1.88	20	000960035
4	72	28	1.96	20	000960040
4,5	78	30	2.03	20	000960045
5	83	32	2.10	20	000960050
5,5	88	35	2.65	20	000960055
6	94	37	2.65	20	000960060
7	99	40	3.30	10	000960070
8	105	43	3.85	10	000960080
9	111	46	4.55	10	000960090
10	119	49	5.40	10	000960100
11	126	52	6.75	10	000960110
12	134	56	8.15	10	000960120
13	142	62	10.40	10	000960130
14	151	69	12.20	10	000960140
16	165	75	17.90	5	000960160
17	174	79	18.70	5	000960170
19	196	88	26.00	5	000960190
22	216	100	41.00	3	000960220
24	242	112	54.00	1	000960240
27	271	125	71.50	1	000960270
30	309	140	96.00	1	000960300
32	341	155	126.50	1	000960312
36	385	174	182.00	1	000960316



	CHF		
96/ST6 2,5-3-4-5-6-8 mm	18.20	3	000960370



	CHF		
96/BGS7 1,5-2-2,5-3-4-5-6 mm	40.50	1	000960367



	CHF		
96/BG7 2,5-3-4-5-6-8-10 mm	42.50	1	000960368

96N

Clé mâle 6 pans coudée, brunie



ISO 2936

mm	L mm	L1 mm	CHF		
0,9	32	10	0.64	20	000960409
1,3	44	12	0.64	20	000960413
1,5	46	15	0.67	20	000960415
2	51	17	0.71	20	000960420
2,5	57	20	0.74	20	000960425
3	64	22	0.82	20	000960430
3,5	68	25	0.98	20	000960435
4	72	28	1.12	20	000960440
4,5	78	30	1.22	20	000960445
5	83	32	1.28	20	000960450
6	94	37	1.60	20	000960460
7	99	40	2.14	10	000960470
8	105	43	2.53	10	000960480
9	111	46	3.30	10	000960490
10	119	49	3.90	10	000960500
11	126	52	4.85	10	000960510
12	134	56	5.90	10	000960520
13	142	62	7.90	10	000960530
14	151	69	8.85	10	000960540
16	165	72	13.40	5	000960560
17	174	79	14.40	5	000960570
19	194	88	19.50	5	000960590
22	216	99	36.00	1	000960592
24	242	111	47.00	1	000960594



96N/ST6
2,5-3-4-5-6-8 mm

CHF 12.80 3 000960640



96N/G7
2,5-3-4-5-6-8-10 mm

CHF 33.50 3 000960645

96N/G7A
1,5-2-2,5-3-4-5-6 mm

CHF 23.40 3 000960643



96N/B10
1,5-2-2,5-3-4-5-6
8-10-12 mm

CHF 21.70 5 000960650

96N/BV
2.47 1 000960651



96N/SC9
1,5-2-2,5-3-4-5-6-8-10 mm

CHF 18.90 1 000960644

96N/SCV
5.50 1 000960986



96N/SC12
2-2,5-3-3,5-4-4,5-5
6-7-8-9-10 mm

CHF 27.00 1 000960661

96N/SCV12
6.60 1 000960976



96C/AS

Clé mâle 6 pans coudée, chromée



"	L mm	L1 mm	g	CHF		
1/16	46	16	1,01	2.22	20	000961702
3/32	53	19	2,70	3.10	20	000961706
1/8	60	22	5,33	3.25	20	000961710
5/32	67	25	9,33	3.80	20	000961714
3/16	74	28	14,87	4.30	20	000961716
7/32	81	32	22,00	4.85	20	000961718
1/4	89	35	31,40	5.40	20	000961720
5/16	103	40	56,16	6.00	10	000961724
3/8	117	45	91,31	7.45	10	000961728



96C-AS/SC9
1/16-3/32-1/8-5/32-3/16-
7/32-1/4-5/16-3/8

CHF 46.00 1 000961753

96AS

Clé mâle 6 pans coudée, brunie



"	L mm	L1 mm	CHF		
1/30 (0,035")	44	14	1.13	20	000960698
1/20 (0,050")	44	15	1.13	20	000960701
1/16	46	16	1.22	20	000960702
5/64	50	18	1.51	20	000960704
3/32	53	19	1.73	20	000960706
7/64	57	21	1.78	20	000960708
1/8	60	22	1.80	20	000960710
9/64	64	24	2.15	20	000960712
5/32	68	25	2.22	20	000960714
3/16	75	29	2.47	20	000960716
7/32	82	32	2.77	20	000960718
1/4	89	35	3.25	20	000960720
5/16	103	40	4.05	10	000960724
3/8	117	44	4.90	10	000960728
7/16	132	49	7.15	10	000960730
1/2	149	54	9.00	10	000960732
9/16	151	69	14.80	2	000960734
5/8	165	72	17.90	1	000960736
3/4	194	88	29.50	1	000960738



96AS/SC9
1/16-3/32-1/8-5/32-3/16
7/32-1/4-5/16-3/8

CHF 30.00 1 000960743

96AS/SCV
5.50 1 000960744



96AS/T7
3/32-1/8-5/32
3/16-7/32-1/4-5/16

CHF 24.20 3 000960740



96AS/BG7
3/32-1/8-5/32-3/16
1/4-5/16-3/8

CHF 42.50 1 000960747



96AS/B11
1/20-1/16-5/64-3/32
1/8-5/32-3/16-7/32
1/4-5/16-3/8

CHF 29.50 1 000960749

96N/BV
2.47 1 000960651



96LC

Clé mâle 6 pans coudée série longue chromée



ISO 2936

mm	L mm	L1 mm	CHF		
2	101	17	2.41	20	000960320
2,5	113	20	2.57	20	000960321
3	127	22	2.81	20	000960322
3,5	138	25	2.87	20	000960323
4	142	28	3.10	20	000960324
4,5	154	28	3.65	20	000960325
5	163	32	3.95	20	000960326
6	184	37	4.30	20	000960327
7	194	40	4.90	10	000960328
8	205	43	6.00	10	000960329
9	216	46	6.65	10	000960330
10	231	49	8.60	10	000960331
12	259	56	10.70	10	000960332



96LC/SC8	CHF 39.00	1	000960334
2-2,5-3-4-5-6-8-10 mm			
96LC/SCV	5.50	1	000960983



96LC/SC12	CHF 58.00	1	000960337
2-2,5-3-3,5-4-4,5-5-6-7-8-9-10 mm			
96LC/SCV12	6.60	1	000960977

96L
Clé mâle 6 pans coudée série longue brunie



ISO 2936

mm	L mm	L1 mm	CHF	U	IT
2	99	15	1.70	20	000960820
2,5	110	17	1.77	20	000960825
3	124	19	2.00	20	000960830
3,5	135	21	2.15	20	000960835
4	138	24	2.39	20	000960840
4,5	150	25	2.77	20	000960845
5	158	27	2.92	20	000960850
6	178	31	3.30	20	000960860
7	187	33	4.20	10	000960870
8	197	35	5.35	10	000960880
9	207	37	5.95	10	000960890
10	221	39	7.95	10	000960900
12	247	44	10.20	10	000960920



96L/SC8	CHF 33.00	1	000960924
2-2,5-3-4-5-6-8-10 mm			
96L/SCV	5.50	1	000960987



96L/SC12	CHF 49.00	1	000960929
2-2,5-3-3,5-4-4,5-5-6-7-8-9-10 mm			
96L/SCV12	6.60	1	000960978

96BP-CL
Clé mâle 6 pans coudée à tête sphérique, chromée, colorée



mm	L mm	L1 mm	CHF	U	IT
1,5	91	16	3.80	5	000961600
2	102	17	4.20	5	000961601
2,5	113	21	4.65	5	000961602
3	128	23	5.20	5	000961603
4	143	28	5.75	5	000961604
5	163	33	6.25	5	000961605
6	185	37	8.00	5	000961606
8	206	43	10.90	2	000961608
10	231	50	14.40	2	000961610



96BP-CL/SC9	CHF 69.00	1	000961619
1,5-2-2,5-3-4-5-6-8-10 mm			
96BP-CL/SCV	5.50	1	000961629

96BPC
Clé mâle 6 pans coudée à tête sphérique, chromée

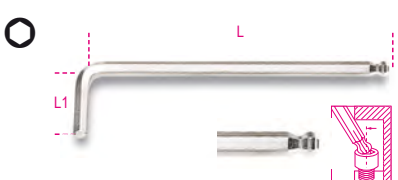

mm	L mm	L1 mm	CHF	U	IT
1,5	79	13	2.84	10	000960340
2	84	15	2.99	10	000960341
2,5	89	17	3.15	10	000960342
3	99	19	3.35	10	000960343
4	108	24	3.85	10	000960344
5	126	27	4.65	10	000960345
6	148	31	6.65	10	000960346
7	157	33	8.75	5	000960353
8	168	35	8.85	5	000960347
10	187	39	14.40	5	000960348
12	220	55	18.50	5	000960352



96BPC/SC9	CHF 56.50	1	000960354
1,5-2-2,5-3-4-5-6-8-10 mm			
96BPC/SCV	5.50	1	000960984

96BP
Clé mâle 6 pans coudée à tête sphérique, brunie

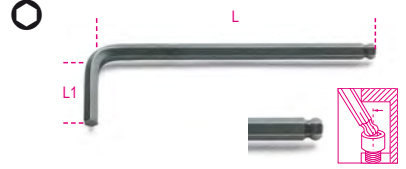

mm	L mm	L1 mm	CHF	U	IT
1,5	79	13	2.15	10	000960960
2	84	15	2.30	10	000960961
2,5	89	17	2.39	10	000960962
3	99	19	2.47	10	000960963
4	108	24	2.84	10	000960965
5	126	27	3.80	10	000960967
6	148	31	5.40	10	000960968
8	168	35	7.75	5	000960970
10	187	39	13.20	5	000960972
12	220	55	19.60	5	000960973



96BP/SC9	CHF 47.50	1	000960974
1,5-2-2,5-3-4-5-6-8-10 mm			
96BP/SCV	5.50	1	000960988

96LBP
Clé mâle 6 pans coudée à tête sphérique, modèle extra long

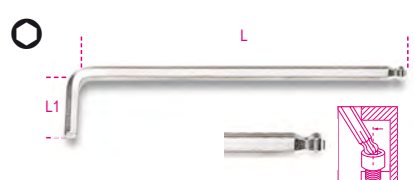

mm	L mm	L1 mm	CHF	U	IT
1,5	90	15	3.30	5	000961340
2	100	17	3.50	5	000961341
2,5	112	20	3.70	5	000961342
3	127	22	3.85	5	000961343
4	144	27	4.70	5	000961344
5	163	32	5.65	5	000961345
6	184	37	7.80	5	000961346
8	204	44	10.70	2	000961348
10	230	49	17.10	2	000961350



96LBP/SC9	CHF 65.50	1	000961354
1,5-2-2,5-3-4-5-6-8-10 mm			
96LBP/SCV	5.50	1	000961984

96BP/AS

Clé mâle 6 pans coudée à tête sphérique, brunie

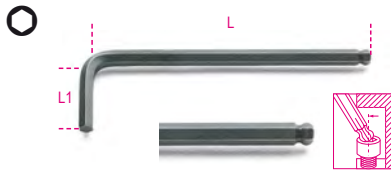

"	L mm	L1 mm	CHF		
3/32	89	17	2.61	10	000960989
1/8	98	18	2.77	10	000960990
5/32	108	24	3.30	10	000960991
3/16	126	26	3.80	10	000960992
7/32	139	28	5.45	10	000960993
1/4	152	31	5.95	10	000960994
5/16	168	34	7.90	5	000960995
3/8	190	39	13.00	5	000960996



	CHF		
96BP-AS/SC9 1/16-3/32-1/8-5/32-3/16	51.50	1	000961000
96BP-AS/SCV 7/32-1/4-5/16-3/8	5.50	1	000961001



	CHF		
96BP-AS/8 3/32-1/8-5/32-3/16-7/32	47.00	1	000960997
96BP-AS/BV 1/4-5/16-3/8	2.47	1	000960998

96BPA

Clé mâle 6 pans coudée à 110° à tête sphérique, modèle côté extra court



mm	L mm	L1 mm	CHF		
1,5	71	9	3.10	5	000961960
2	86	11	3.25	5	000961961
2,5	96	13	3.35	5	000961962
3	104	15	3.70	5	000961963
4	116	17	4.40	5	000961964
5	132	19	5.25	5	000961965
6	155	21	7.65	5	000961966
8	176	24	10.10	2	000961968
10	200	27	15.80	2	000961970



	CHF		
96BPA/SC9 1,5-2-2,5-3-4-5-6-8-10 mm	62.00	1	000961974
96BPA/SCV	5.50	1	000961988

96T CLÉS 6 PANS COUDÉES avec poignées hautes performances

Rapide et facile à manipuler

La poignée de taille réduite est parfaitement équilibrée afin de pouvoir pivoter rapidement dans la paume de la main.

La forme ergonomique permet d'appliquer des couples extrêmement élevés.

Les extrémités hexagonales ont été conçues pour transmettre le maximum de couple possible à la vis.

La lame ronde est homogène par rapport à la lame hexagonale ce qui offre une résistance accrue.



La lame passe intégralement à l'intérieur de la poignée

96T

Clé mâle 6 pans à poignée en T haute performance

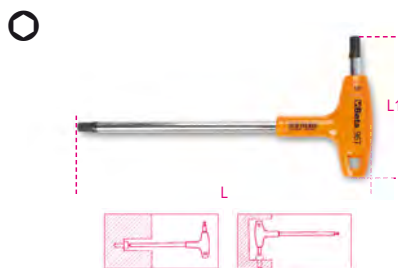

mm	L mm	L1 mm	CHF		
2	139	52	14.80	5	000960934
2,5	153	55	14.80	5	000960935
3	153	55	15.50	5	000960936
3,5	179	70	16.00	5	000960937
4	179	70	16.00	5	000960938
4,5	200	84	16.40	5	000960939
5	200	84	16.40	5	000960940
6	221	103	18.70	5	000960941
7	236	106	20.60	3	000960942
8	255	117	23.90	3	000960943
10	285	132	27.50	3	000960945



	CHF		
96T/S6 2-2,5-3-4-5-6 mm	96.00	1	000960952
96T/S8 2-2,5-3-4-5-6-8-10 mm	147.50	1	000960933
96T/S11 2-2,5-3-3,5-4-4,5-5-6-7-8-10 mm	200.00	1	000960951



	CHF		
96T/SP11 2-2,5-3-3,5-4-4,5-5-6-7-8-10 mm	236.00	1	000960957
96T/SPV 96T/S11 97TTX/S11	44.50	1	000960958

96T/AS

Clé mâle 6 pans à poignée en T haute performance

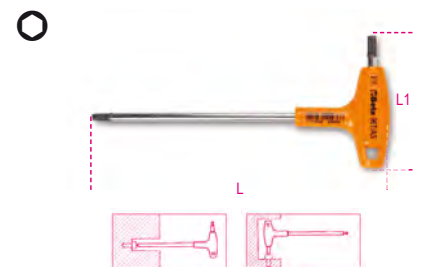

"	L mm	L1 mm	CHF		
3/32	153	55	18.40	2	000960669
7/64	153	55	18.40	2	000960670
1/8	179	70	18.60	2	000960671
9/64	179	70	19.50	2	000960672
5/32	200	84	19.50	2	000960673
3/16	200	84	19.50	2	000960674
7/32	221	103	21.70	2	000960675
1/4	236	106	24.20	2	000960676
5/16	255	117	27.50	2	000960678
3/8	285	132	33.00	2	000960680



	CHF		
96T/AS8 3/32-7/64-1/8-5/32-3/16-1/4-5/16-3/8	178.50	1	000960682
96T/AS10 3/32-7/64-1/8-9/64-5/32-3/16-7/32-1/4-5/16-3/8	220.00	1	000960683

96TBP

Clé mâle 6 pans coudée
à tête sphérique et à poignée en T
haute performance



mm	L mm	L1 mm	CHF	🔧	📦
2,5	153	55	15.50	3	000960685
3	153	55	16.30	3	000960686
4	179	70	17.10	3	000960687
5	200	84	17.90	3	000960688
6	221	103	19.50	3	000960689
8	255	117	26.00	2	000960690
10	285	132	27.50	2	000960692



96TBP/S6
2,5-3-4-5-6-8 mm

CHF 112.00 1 000960694

97TX

Clé mâle coudée pour vis TORX(R)



	L mm	L1 mm	CHF	🔧	📦
T6	42	16	8.25	5	000970006
T7	48	16	8.25	5	000970007
T8	48	16	8.25	5	000970008
T9	48	16	9.05	5	000970009
T10	51	17	9.25	5	000970010
T15	54	18	9.25	5	000970015
T20	57	19	9.85	5	000970020
T25	60	20	10.10	5	000970025
T27	64	21	11.00	5	000970027
T30	70	24	11.00	5	000970030
T40	76	26	12.30	5	000970040
T45	83	29	14.80	5	000970045
T50	95	32	16.90	5	000970050
T55	108	35	21.50	5	000970055
T60	120	38	28.50	5	000970060



97TX/ST8
T9-T10-T15-T20-T25
T27-T30-T40

CHF 88.50 1 000970640



97TX/G8
T9-T10-T15-T20-T25
T27-T30-T40

CHF 69.50 1 000970645



97TX/BG8
T9-T10-T15-T20-T25-T27-T30-T40

CHF 55.00 1 000970368



97TX/SC8
T9-T10-T15-T20-T25
T27-T30-T40

CHF 87.50 1 000970064

97TX/SCV 5.50 1 000970985



97TX/B13
T6-T7-T8-T9-T10-T15-T20
T25-T27-T30-T40-T45-T50

CHF 140.50 1 000970650

96N/BV 2.47 1 000960651

97BTX

Clé mâle coudée à tête sphérique
pour vis TORX(R)



	L mm	L1 mm	CHF	🔧	📦
T9	62	16	10.50	5	000970109
T10	71	17	10.50	5	000970110
T15	81	18	10.50	5	000970115
T20	92	19	11.30	5	000970120
T25	94	20	12.00	5	000970125
T27	105	21	12.80	5	000970127
T30	114	24	12.90	5	000970130
T40	129	26	14.90	5	000970140
T45	133	28	17.50	5	000970145
T50	152	32	19.60	3	000970150
T55	164	35	28.00	3	000970155



97BTX/SC8
T9-T10-T15-T20-T25-T27-T30-T40

CHF 101.00 1 000970164

97BTX/SCV 5.50 1 000970983



97BTX/B8
T9-T10-T15-T20-T25
T27-T30-T40

CHF 98.00 1 000970159

96N/BV 2.47 1 000960651

97BTX-C

Clé mâle coudée colorée
à tête sphérique pour vis Torx®



	L mm	L1 mm	CHF	🔧	📦
T9	80	16	11.60	5	000971609
T10	86	17	11.60	5	000971610
T15	90	18	11.60	5	000971615
T20	95	19	12.70	5	000971620
T25	100	20	13.50	5	000971625
T27	105	21	14.30	5	000971627
T30	114	24	14.80	5	000971630
T40	124	26	16.30	5	000971640



97BTX-C/SC8
T9-T10-T15-T20-T25-T27-T30-T40

CHF 111.50 1 000971658

97BTX-C/SCV 5.50 1 000971659



97BTXL

Clé mâle coudée à tête sphérique, série longue, pour vis Torx®



	L mm	L1 mm	CHF		
T9	80	15	11.00	3	000970309
T10	86	17	11.00	3	000970310
T15	100	18	11.00	3	000970315
T20	110	19	12.70	3	000970320
T25	126	20	13.90	3	000970325
T27	140	24	15.60	3	000970327
T30	160	28	16.30	3	000970330
T40	176	32	19.40	3	000970340



	CHF		
97BTXL/SC8 T9-T10-T15-T20- T25-T27-T30-T40	116.50	1	000970364
97BTXL/SCV	5.50	1	000970982

97RTX

Clé mâle coudée pour vis Tamper Resistant Torx®



	L mm	L1 mm	CHF		
T6	40	15	10.00	5	000970206
T7	45	15	10.00	5	000970207
T8	50	16	10.00	5	000970208
T9	56	16	10.00	5	000970209
T10	62	17	10.00	5	000970210
T15	72	17	10.00	5	000970215
T20	83	18	10.20	5	000970220
T25	90	18	10.50	5	000970225
T27	100	20	11.90	5	000970227
T30	105	24	12.00	5	000970230
T40	112	26	13.20	5	000970240
T45	118	26	15.50	5	000970245
T50	122	28	20.00	3	000970250
T55	128	30	22.90	3	000970255



	CHF		
97RTX/SC8 T9-T10-T15-T20-T25 T27-T30-T40	93.00	1	000970263
97RTX/SCV	5.50	1	000970984



	CHF		
97RTX/B8 T9-T10-T15-T20-T25 T27-T30-T40	90.00	1	000970260
96N/BV	2.47	1	000960651

97TTX

Clé mâle pour vis TORX® à poignée en T haute performance



	L mm	L1 mm	CHF		
T6	130	52	15.30	3	000970706
T7	130	52	15.30	3	000970707
T8	139	52	15.40	3	000970708
T9	139	52	15.40	3	000970709
T10	179	70	15.80	3	000970710
T15	179	70	17.00	3	000970715
T20	179	70	17.60	3	000970720
T25	179	70	18.70	3	000970725
T27	200	84	20.60	3	000970727
T30	200	84	21.30	3	000970730
T40	221	103	25.50	3	000970740
T45	236	106	29.50	2	000970745
T50	255	117	38.00	2	000970750



	CHF		
97TTX/S6 T10-T15-T20-T25-T30-T40	116.00	1	000970791
97TTX/S8 T8-T10-T15-T20-T25- T27-T30-T40	152.00	1	000970808
97TTX/S11 T8-T9-T10-T15-T20-T25 T27-T30-T40-T45-T50	234.50	1	000970800
97TTX/S13 T6-T7-T8-T9-T10-T15-T20-T25 T27-T30-T40-T45-T50	265.00	1	000970813



	CHF		
97TTX/SP11 T8-T9-T10-T15-T20-T25 T27-T30-T40-T45-T50	270.00	1	000970840
96T/SPV 96T/S11 97TTX/S11	44.50	1	000960958

98XZN

Clé mâle coudée XZN®



DIN 65253

	L mm	L1 mm	CHF		
M5	83	25	7.15	5	000980005
M6	89	30	8.20	5	000980006
M8	97	32	10.40	5	000980008
M10	106	35	13.60	5	000980010
M12	116	37	17.20	5	000980012
M14	118	45	21.80	5	000980014
M16	125	45	32.00	5	000980016



	CHF		
98XZN/B5 M5-M6-M8-M10-M12	59.00	1	000980650
96N/BV	2.47	1	000960651

99

Clé à ergot pour écrous à encoches latérales UNI/ISO 2982, 2983



UNI 6752

	A mm	CHF		
12-14	1,5	13.80	3	000990012
16-18-20	1,8	13.80	3	000990016
22-25-28	1,8	18.40	3	000990022
30-32	2,1	18.40	3	000990030
34-36-38	2,4	22.30	3	000990034
40-42	2,4	22.30	3	000990040
45-50	2,5	27.50	3	000990045
52-55-58	2,5	27.50	3	000990052
62-65	3,1	34.50	3	000990062
68-70-75	3,1	34.50	3	000990068
80-85-90	3,8	46.50	2	000990080
92-95	4,3	46.50	2	000990092
98-100	4,3	46.50	2	000990098
105-110-115	4,4	73.50	1	000990105
120-125-130	4,9	73.50	1	000990120
135-145	6,0	108.50	1	000990135
155-165	6,0	108.50	1	000990155

99SQ

Clé à ergot articulée pour écrous à encoches latérales



	B mm	CHF		
15-35	2,7	37.00	2	000990215
35-50	3,5	42.00	2	000990235
50-80	4,7	55.00	2	000990250
80-120	6,2	75.50	2	000990280
120-180	7,8	101.00	2	000990290

99ST

Clé à ergot articulée pour écrous à trous latéraux



Ø mm	Ø mm	B mm	CHF	🔧	📦
15-35	3,0	2,5	38.00	2	000990315
35-50	4,0	4,5	44.50	2	000990335
50-80	5,0	5,0	59.50	2	000990350
80-120	6,0	7,0	81.00	2	000990380
120-180	8,0	9,0	105.50	2	000990390

99 VN/...

Ergot pour 99ST

	Ø mm	CHF	🔧	📦
99ST VN/15	15-35	10.40	1	000990295
99ST VN/35	35-50	12.00	1	000990296
99ST VN/50	50-80	14.80	1	000990297
99ST VN/80	80-120	17.00	1	000990298
99ST VN/120	120-180	22.30	1	000990299

100

Clé à ergots pour écrous à empreintes sur le dessus



Ø mm	L mm	Ø min-max mm	CHF	🔧	📦
4,9-5,9	250	18÷100	194.00	1	001000001
6,9-7,9					

100/KIT

Ergots pour art. 100



	CHF	🔧	📦
100/KIT	59.50	1	001000010

111E

CLÉS À MOLETTE À OUVERTURE GRADUÉE

Les nouvelles clés à molette Beta 111XX permettent de visser et de dévisser des écrous et des boulons de différentes tailles grâce à la mâchoire mobile, l'ajustage se fait à l'aide de la molette située au centre. Tête inclinée à 15° permettant de l'utiliser dans les espaces les plus difficiles comme nos iconiques clés mixtes "42".



Ouverture de clé très large

Faible encombrement de la tête de la mâchoire lors de sa complète ouverture.

Double marquage laser en mm/pouces



L'étude de la nouvelle ergonomie permet d'obtenir la réduction de 20% de son poids. Fabriquée en acier allié haute performance pour une grande résistance mécanique à la torsion. Traitements thermiques dédiés pour une excellente résistance à l'usure. Orifice sur le manche de la clé permettant de l'accrocher.

111E

Clé à molette à ouverture graduée, chromée

- Rotation de la molette vers la droite
- Échelle millimétrique et en pouces



DIN 3117 ISO 6787

L mm	L"	A max mm	CHF	🔧	📦
100	4	15	32.00	3	001110110
150	6	24	33.50	3	001110115
200	8	29	41.00	3	001110120
250	10	34	49.50	3	001110125
300	12	40	65.50	3	001110130
380	15	45	129.00	3	001110138
450	18	54	214.50	2	001110145
600	24	62	297.00	1	001110160

111EN

Clé à molette à ouverture graduée, phosphatée

- Rotation de la molette vers la gauche
- Échelle millimétrique et en pouces



DIN 3117 ISO 6787

L mm	L"	A max mm	CHF	🔧	📦
100	4	15	29.50	3	001110410
150	6	24	31.00	3	001110415
200	8	29	36.00	3	001110420
250	10	34	44.50	3	001110425
300	12	40	60.00	3	001110430
380	15	45	119.00	3	001110438
450	18	54	202.50	2	001110445

111ER

Clé à molette à ouverture graduée et à mâchoire réversible, chromée

- Mâchoire réversible
- Rotation de la molette vers la droite
- Échelle millimétrique et en pouces



L mm	L"	A max mm	Ø max	CHF	🔧	📦
200	8	29	3/4	42.50	3	001110520
250	10	34	1	52.50	3	001110525
300	12	40	1.1/4	69.00	2	001110530

111CM

Clé à molette courte à ouverture majorée, chromée

- Ouverture majorée
- Rotation vers la droite
- Échelle millimétrique et en pouces



L mm	L"	A max mm	CHF	🔧	📦
170	6	32	49.00	2	001110770
220	8	38	59.50	3	001110722
270	10	46	78.50	3	001110727

Beta

120

Clé à tuyauter à cliquet

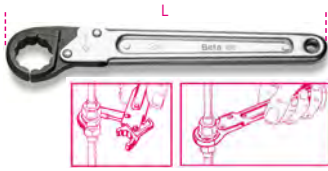

Ø mm	L mm	CHF	🔧	📦
10	135	61.50	1	001200010
11	135	61.50	1	001200011
12	135	61.50	1	001200012
13	135	61.50	1	001200013
14	135	69.50	1	001200014
17	185	75.00	1	001200017
19	185	80.00	1	001200019
22	230	108.50	1	001200022
24	230	116.50	1	001200024
27	230	148.00	1	001200027
30	320	168.00	1	001200030
32	320	178.00	1	001200032



120/B6N 10-11-13 17-19-22 mm	CHF 463.00	🔧	📦	1 001200060
2002/BVL6	14.40	🔧	📦	1 020020010

123E1/4

Adaptateur porte-embouts 1/4" pour clés à cliquet 10 mm



Ø mm	L mm	CHF	🔧	📦
10	20,6	8.05	1	001230010

123Q1/4

Adaptateur pour douilles 1/4" à déverrouillage rapide, pour clés à cliquet 10 mm

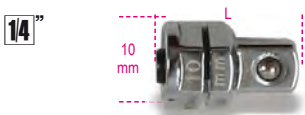

Ø mm	L mm	CHF	🔧	📦
10	17,5	11.20	1	001230310

123Q3/8

Adaptateur pour douilles 3/8" à déverrouillage rapide, pour clés à cliquet 13 mm



Ø mm	L mm	CHF	🔧	📦
13	22,5	11.30	1	001230313

123Q1/2

Adaptateur pour douilles 1/2" à déverrouillage rapide, pour clés à cliquet 19 mm



Ø mm	L mm	CHF	🔧	📦
19	30,5	12.00	1	001230319

123/K4

Kit de 4 adaptateurs pour clés à cliquet :
1 adaptateur porte-embouts
3 adaptateurs pour douilles à déverrouillage rapide



123/K4	CHF 42.50	🔧	📦	1 001230504
--------	--------------	---	---	-------------

141

Clé mixte droite à cliquet



ISO 21982:2020

Ø mm	L mm	CHF	🔧	📦
8x8	136	20.20	3	001410008
9x9	143	21.10	3	001410009
10x10	160	21.70	3	001410010
11x11	168	22.10	3	001410011
12x12	174	22.90	3	001410012
13x13	180	24.90	3	001410013
14x14	193	26.00	2	001410014
15x15	200	27.00	2	001410015
16x16	216	29.50	2	001410016
17x17	233	31.00	2	001410017
18x18	239	32.00	2	001410018
19x19	250	33.00	2	001410019



141/B6 8-10-13-14-17-19 mm	CHF 168.00	🔧	📦	1 001410066
141/B9 8-10-11-12-13-14-15-17-19 mm	242.50	🔧	📦	1 001410069



141/S12 8-9-10-11-12-13-14-15-16-17-18-19 mm	CHF 311.00	🔧	📦	1 001410072
---	---------------	---	---	-------------

142

CLÉS À CLIQUET

Le cliquet rapide à 72 dents offre un angle de reprise de 5°, ce qui permet un serrage rapide et précis.

1 L'oeil fixe de la clé permet un serrage fort, calculé par rapport à la longueur de la clé.

2 Le bouton d'inversion intégré évite tout risque d'inversion accidentelle.

3 - 4 L'extrémité de l'œil de la clé est inclinée à 15° par rapport à l'axe ce qui réduit l'angle de reprise mais il permet également de protéger la main de l'utilisateur et de faciliter l'accès au travail de l'outil.



142

Clé mixte à cliquet réversible



ISO 21982:2020

Ø mm	L mm	CHF	🔧	📦
6x6	136	22.10	3	001420006
7x7	136	22.10	3	001420007
8x8	136	22.80	3	001420008
9x9	143	24.40	3	001420009
10x10	159	25.00	3	001420010
11x11	168	26.00	3	001420011
12x12	174	26.50	3	001420012
13x13	180	29.00	3	001420013
14x14	190	29.50	2	001420014
15x15	200	31.50	2	001420015
16x16	216	34.00	2	001420016
17x17	233	35.50	2	001420017
18x18	239	38.00	2	001420018
19x19	248	38.50	2	001420019
21x21	285	49.50	1	001420021
22x22	285	51.50	1	001420022
24x24	325	59.50	1	001420024
27x27	355	86.00	1	001420027
30x30	420	101.00	1	001420030
32x32	420	104.50	1	001420032
34x34	482	146.50	1	001420034
36x36	482	147.50	1	001420036
38x38	482	150.50	1	001420038



	CHF	U	Icon
142/B6 8-10-13-14-17-19 mm	191.50	1	Icon
142/BV6	11.20	1	Icon
142/B9 8-10-11-12-13-14-15-17-19 mm	278.00	1	Icon
142/BV9	13.40	1	Icon



	CHF	U	Icon
142/S15 6-7-8-9-10-11-12-13 14-15-16-17-18-19-22 mm	456.00	1	Icon
142/S17 6-7-8-10-11-12-13-14-15- 16-17-18-19-21-22-24-27 mm	627.00	1	Icon
142/S19 6-7-8-9-10-11-12 13-14-15-16-17-18 19-22-24-27-30-32 mm	808.00	1	Icon

142/SC9I-E

Jeu de 9 clés mixtes à cliquet réversible avec support compact



	CHF	U	Icon
142/SC9I 8-10-11-12-13-14-15-17-19 mm	275.00	1	Icon
142/SCV9I	13.00	1	Icon
142/SC9E 8-10-11-12-13-16-17-18-19 mm	286.00	1	Icon
142/SCV9E	13.00	1	Icon

142MC

Clé mixte à cliquet réversible colorée



ISO 21982:2020

mm	L mm	CHF	U	Icon
8x8	136	24.10	3	Icon
10x10	159	26.00	3	Icon
11x11	168	27.00	3	Icon
12x12	174	28.00	3	Icon
13x13	180	30.00	3	Icon
14x14	190	31.50	2	Icon
15x15	200	33.00	2	Icon
16x16	216	36.50	2	Icon
17x17	233	37.00	2	Icon
18x18	239	39.00	2	Icon
19x19	248	40.50	2	Icon



	CHF	U	Icon
142MC/SC9I 8-10-11-12-13-14-15-17-19 mm	288.00	1	Icon
142MC/SC9E 8-10-11-12-13-16-17-18-19 mm	299.00	1	Icon

142AS

Clé mixte à cliquet réversible



mm	L mm	CHF	U	Icon
5/16x5/16	136	27.00	2	Icon
3/8x3/8	159	27.50	2	Icon
7/16x7/16	168	29.00	2	Icon
1/2x1/2	180	33.00	2	Icon
9/16x9/16	190	33.50	2	Icon
5/8x5/8	216	37.00	2	Icon
11/16x11/16	233	38.00	2	Icon
3/4x3/4	248	41.50	2	Icon



	CHF	U	Icon
142AS/8 5/16-3/8-7/16-1/2 9/16-5/8-11/16-3/4	267.00	1	Icon

142C

Clé mixte à cliquet - série courte droite



ISO 21982:2020

mm	L mm	CHF	U	Icon
8x8	88	16.50	2	Icon
9x9	96	16.50	2	Icon
10x10	96	17.10	2	Icon
11x11	100	18.20	2	Icon
12x12	104	19.40	2	Icon
13x13	108	20.20	2	Icon
14x14	114	21.10	2	Icon
15x15	118	21.80	2	Icon
16x16	122	22.50	2	Icon
17x17	128	24.40	2	Icon
18x18	132	26.00	2	Icon
19x19	138	27.00	2	Icon



	CHF	U	Icon
142C/A12 8-9-10-11-12-13-14 15-16-17-18-19 mm	284.00	1	Icon

142SN

Clé mixte à cliquet articulé



ISO 21982:2020

mm	L mm	CHF	U	Icon
7x7	136	26.50	2	Icon
8x8	136	27.50	2	Icon
9x9	143	28.50	2	Icon
10x10	160	30.00	2	Icon
11x11	168	31.50	2	Icon
12x12	174	33.00	2	Icon
13x13	180	35.50	2	Icon
14x14	193	36.50	2	Icon
15x15	200	38.50	2	Icon
16x16	216	41.00	2	Icon
17x17	233	41.50	2	Icon
18x18	239	44.50	2	Icon
19x19	250	45.00	2	Icon
22x22	285	54.00	1	Icon
24x24	325	60.00	1	Icon



	CHF	U	Icon
142SN/S13 7-8-9-10-11-12-13-14 15-16-17-18-19 mm	460.00	1	Icon



	CHF	U	Icon
142SN/SC9 8-10-11-12-13-14-15-17-19 mm	330.00	1	Icon

186

Clé auto-serrante à reprise automatique pour 6 pans de 8 à 32 mm

Idéale pour vis à tête : à six pans, Spline, carrée, Torx® ; même abîmées.



L mm	CHF	🔧	📄
260	62.50	1	001860008

187

Clé ouvrable articulée



mm	L mm	CHF	🔧	📄
8x9	125	42.50	1	001870008
10x11	155	46.00	1	001870010
12x13	175	47.00	1	001870012
14x15	205	52.00	1	001870014
16x17	235	59.00	1	001870016



187/B5	CHF	🔧	📄
8x9-10x11-12x13 14x15-16x17 mm	260.00	1	001870050

188

Clé polygonale droite à cliquet pour poulies libres alternateurs



mm	L mm	CHF	🔧	📄
10	240	28.50	2	001880010
15	322	39.00	2	001880015

192

Clé polygonale double droite à cliquet réversible 4 en 1



mm	L mm	CHF	🔧	📄
8x10/12x13 16x17/18x19	160 230	36.50 46.50	1	001920008 001920016

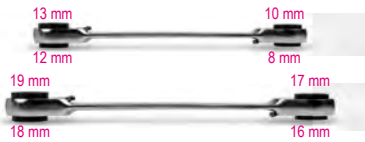

192/S2	CHF	🔧	📄
8x10/12x13 mm 16x17/18x19 mm	83.00	1	001920070

194

Clé à cliquet réversible porte-embouts



1/4x5/16	L mm	CHF	🔧	📄
	128	46.50	2	001940006

195

Clé polygonale double droite à cliquet



mm	L mm	CHF	🔧	📄
8x10	128	25.50	2	001950010
12x13	170	29.00	2	001950013
14x15	190	30.50	2	001950015
16x18	230	36.00	2	001950018
17x19	230	38.00	2	001950019



195/B5	CHF	🔧	📄
8x10-12x13-14x15 16x18-17x19 mm	172.50	1	001950066
195/BV5	13.40	1	001950070

195AS

Clé polygonale droite à cliquet



mm	L mm	CHF	🔧	📄
5/16x3/8	128	26.00	2	001950606
7/16x1/2	170	29.00	2	001950611
9/16x5/8	190	33.00	2	001950614
11/16x3/4	230	37.00	2	001950617



195AS/B4	CHF	🔧	📄
5/16x3/8 - 7/16x1/2 - 9/16x5/8 - 11/16x3/4	139.00	1	001950654
195FTX/BV4	13.40	1	001950520

195P

Clé 12 pans coudée à 15° à cliquet réversible



ISO 21982:2020

mm	L mm	CHF	🔧	📄
8x10	128	38.50	2	001950210
12x13	170	41.00	2	001950213
14x15	190	42.00	2	001950215
16x18	230	47.00	2	001950218
17x19	230	49.50	2	001950219



195P/B5	CHF	🔧	📄
8x10-12x13-14x15 16x18-17x19 mm	232.00	1	001950266
195/BV5	13.40	1	001950070

310

Fer à souder les tubes sanitaires PE, PP, PVC et PEHD

CE



230V-650 Watt
50 Hz+60Hz
Schuko (CEE 7/7)

	Ø mm	CHF	🔧	📄
310/1	16÷50	353.00	1	003100001
310/2	16÷63	494.00	1	003100002

310B

Embout pour 310



mm	CHF	🔧	📄
16	84.50	1	003100016
20	92.50	1	003100020
25	98.50	1	003100025
32	109.00	1	003100032
40	129.00	1	003100040
50	163.00	1	003100050
63	188.00	1	003100063





310/C4

Fer à souder avec composition de 3 matrices



310/C4 CHF 708.00 1 003100104
 310/1+310B: Ø 20-25-32
 410x260x82 mm - 4,8 kg

310/C8

Fer à souder avec composition de 7 matrices



310/C8 CHF 1,107.00 1 003100108
 310/2+310B: Ø 16-20-25
 32-40-50-63
 440x270x120 mm - 7,7 kg

311

Fer à souder les tubes d'évacuation en PE



311/1 CHF 439.00 1 003110001
 120 300
311/2 CHF 489.00 1 003110002
 190 900

DOMAINE D'UTILISATION DES COUPES TUBES BETA

Les coupe-tubes Beta couvrent un large éventail d'applications. Ils s'utilisent sur des tubes précis et lisses et l'avance effectuée par la vis télescopique permet des coupes précises et nettes sur tous les matériaux utilisés pour les tuyaux.

Le tableau ci-dessous présente les combinaisons coupe-tubes/molette de coupe prévu pour chaque matériau.

	TUYAUX DE GAZ EN ACIER		
	10 mm	60 mm	115 mm
	1/8"	2"	4"
330/2			
330/4			

	TUYAUX DE GAZ EN ACIER INOXYDABLE		
	10 mm	60 mm	115 mm
	1/8"	2"	4"
330/2+330R/12			
330/4+330R/14			

	TUYAUX CUIVRE ET ALLIAGE LEGER							
	3 mm	6 mm	8 mm	16 mm	28 mm	30 mm	38 mm	67 mm
	1/8"	1/4"	5/16"	5/8"	1"1/8"		1"1/2"	2"5/8"
332								
334								
336								
338								

	TUYAUX MINCES EN ACIER INOXYDABLE							
	3 mm	6 mm	8 mm	16 mm	28 mm	30 mm	38 mm	67 mm
	1/8"	1/4"	5/16"	5/8"	1"1/8"		1"1/2"	2"5/8"
332 + 334R/I								
334 + 334R/I								
336 + 338R/I								
338 + 338R/I								

	TUYAUX EN PLASTIQUE							
	6 mm	8 mm	16 mm	30 mm	38 mm	50 mm	67 mm	127 mm
	1/4"	5/16"	5/8"	1"1/8"	1"1/2"	2"	2"5/8"	5"
336 + 338RP								
338 + 338RP								
339A								

330

Coupe-tubes pour tubes acier



	Ø mm - "	L mm	CHF		
330/2	10÷60 1/8"÷ 2"	380	209.50	1	003300002
330/4	60÷115 2"÷ 4"	585	476.00	1	003300004

330R/I

Molette pour article 330 pour acier inox



	Ø mm	S mm	CHF		
330R/I2	32	7	44.50	1	003300024
330R/I4	32	9	126.00	1	003300034

330R/A

Molette pour article 330 pour tubes en acier

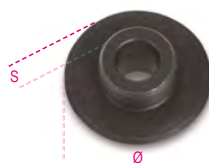

	Ø mm	S mm	CHF		
330R/A2	32	7	20.10	1	003300012
330R/A4	42	9	52.00	1	003300014

331C

Coupe-tubes de poche en en forme de C pour tubes cuivre et alliages légers



	Ø mm	L mm	CHF		
15÷22	78		74.50	1	003310050

332

Coupe-tubes pour tubes cuivre et alliages légers



Ø mm - "	L mm	CHF		
3÷16 1/8"±5/8"	59	30.00	2	003320001
3÷28 1/8"±1"1/8"	63	33.50	2	003320003

334

Coupe-tubes pour tubes cuivre et alliages légers



Ø mm - "	L mm	CHF		
3÷30 1/8"±1"1/8"	150	41.50	1	003340001

334R

Molette pour article 332 et 334 pour cuivre et alliages légers

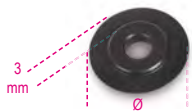

Ø mm	CHF		
334R 18	8.95	1	003340021

334R/I

Molette pour article 332 et 334 pour acier INOX



Ø mm	CHF		
334R/I 18	25.50	1	003340023

336

Coupe-tubes à avance télescopique rapide pour cuivre et alliages légers



Ø mm - "	L mm	CHF		
6÷38 1/4"±1"1/2"	160	69.00	1	003360001

338

Coupe-tubes à avance télescopique rapide pour cuivre, alliages légers et plastiques



Ø mm - "	L mm	CHF		
6÷67 1/4"±2"5/8"	290	171.00	1	003380001

338R

Molette pour article 331L, 336 et 338 pour cuivre et alliages légers



Ø mm	CHF		
338R 18,5	9.45	1	003380022

338R/I

Molette pour article 336 et 338 pour acier INOX



Ø mm	CHF		
338R/I 21,8	28.00	1	003380023

338RP

Molette pour article 336 et 338 pour plastiques



Ø mm	CHF		
338RP 21,9	10.20	1	003380025

339A

Coupe-tubes à avance télescopique rapide pour tube PVC



Ø mm - "	L mm	CHF		
50÷127 2"±5"	345	366.00	1	003390011

339A/R

Molette pour 339A

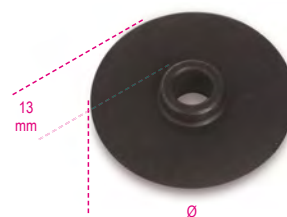

Ø mm	CHF		
339A/R 42	25.50	1	003390061

340

Pince coupe-tubes pour tube multicouche Ø max 26 mm

Lame revêtue en PTFE
4 rouleaux d'appui pour faciliter la rotation du tube pendant la coupe
Système pour la coupe des tubes crantés intégré dans le manche

Corps léger en magnésium



Ø max mm	CHF		
340 26	142.50	1	003400001

340RL

Lame pour 340



CHF		
340RL 40.50	1	003400010

340C

pincines de coupe de tuyaux ondulés

pincines en alliage d'aluminium et de magnésium · compact, format de poche, léger · lame supplémentaire pour la coupe longitudinale



Ø mm	L mm	CHF		
14-45	134	67.50	1	003400050

340C/KRL

kit de 3 lames de rechange pour 340C



		CHF		
340C/KRL		40.50	1	003400055

341

Pince coupe-tubes en PVC



Ø mm	L mm	CHF		
0÷25	190	51.00	1	003410001

341RL

Lame pour 341



		CHF		
341RL		22.80	1	003410010

341B

Coupe-tubes PVC à cliquet pour tubes plastiques

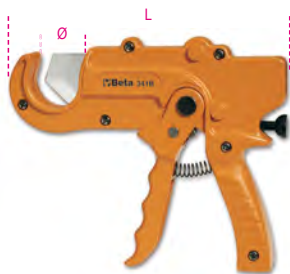

Ø mm	L mm	CHF		
0÷35	195	93.00	1	003410051

341B/RM

Ressort de rechange pour 341B

		CHF		
341B/RM		3.50	1	003410061

341B/RL

Lame pour 341B



		CHF		
341B/RL		34.50	1	003410060

342

Coupe-tubes PVC à cliquet pour tubes plastiques



Ø mm - "	L mm	CHF		
0÷42 1"5/8	200	68.00	1	003420030

342MOL

Ressort de rechange pour 342

		CHF		
342MOL		4.95	1	003420033

342RL

Lame de rechange pour 342



		CHF		
342RL		31.00	1	003420032

342A

Coupe-tubes PVC à cliquet pour tubes plastiques



Ø mm - "	L mm	CHF		
0÷50 2"	270	139.50	1	003420101

342A/MOL

Ressort de rechange pour 342A

		CHF		
342A/MOL		3.05	1	003420111

342A/RL

Lame pour 342A



		CHF		
342A/RL		72.50	1	003420110

342P

Coupe-tubes à cliquet en alliage de magnésium pour tubes plastiques



Ø mm - "	L mm	CHF		
0÷50 2"	260	151.00	1	003420121

342P/RL

Lame pour 342P



		CHF		
342P/RL		63.00	1	003420130



345

Ébavureur tonneau corps en métal

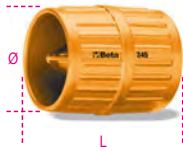

∅ mm - "	L mm	CHF	🔧	📄
3÷42 1/8"÷1"5/8	58	36.50	5	003450001

345U

Ébavureur tonneau pour inox, acier, cuivre et alliages légers



∅ mm - "	L mm	CHF	🔧	📄
4÷36 5/32÷1"7/16	60	96.50	1	003450050

345U/A

adaptateur pour aléuseur de tuyau 345U, Entraînement hexagonal 1/4 », pour pilotes d'alimentation



L mm	CHF	🔧	📄
90	24.70	3	003450055

345C

Appareil d'étalonnage pour tuyaux multicouche



∅ mm	CHF	🔧	📄
16-20-26-32	58.00	1	003450032

345SB

Ébavureur à lame tournante



L mm	CHF	🔧	📄
150	30.00	5	003450010

345SB/R

Lame pour 345SB



CHF	🔧	📄
10.70	3	003450015

345SB2

Ébavureur à lame fixe



L mm	CHF	🔧	📄
140	15.10	5	003450022

345SC

Écouvillon 4 en 1 pour diamètres intérieurs et extérieurs 1/2" et 3/4"



L mm	L1 mm	L2 mm	CHF	🔧	📄
195	28	32	17.70	2	003450060

345SI

Ébavureur interne à lame interchangeable tournante



L mm	∅ mm	CHF	🔧	📄
168	16,5	57.50	1	003450040

345SI/R

Lame pour 345SI



CHF	🔧	📄
39.50	1	003450045

349

Appareil à collets réglable pour cuivre et alliages légers



∅ mm - "	CHF	🔧	📄
6-8-10-12-14-15-16-18 (1/8-3/16-1/4-5/16 3/8-1/2-5/8-3/4)	363.00	1	003490001

270x200x50 mm - 2,7 kg

349/SMM

Glissière métrique pour 349



∅ mm	CHF	🔧	📄
6-8-10-12-14-15-16-18	106.50	1	003490011

349/SMAS

Glissière en pouces pour 349



∅ "	CHF	🔧	📄
1/8-3/16-1/4-5/16 3/8-1/2-5/8-3/4	100.50	1	003490012

350

Appareil à collets pour cuivre et alliages légers



Ø mm	L mm	A mm	CHF	1	003500001
4-4,75-6-8-10-12-14	175	104	105.50	1	003500001

351C

Coffret appareil à collets pour cuivre et alliages légers en coffret plastique



351C	CHF	1	003510010
	191.00	1	003510010

334 Ø 3+30 mm (1/8"+1"1/8)

350 Ø 4+14 mm

351P Ø 4-4,75-6-8-10-12-14 mm

225x150x45 mm - 1,6 kg

351P

Embout pour 350



351P	Ø mm	CHF	3	003510101
4	4	8.75	3	003510101
4,75	4,75	8.75	3	003510102
6	6	8.75	3	003510103
8	8	8.75	3	003510104
10	10	8.75	3	003510105
12	12	8.75	3	003510106
14	14	8.75	3	003510107

352U

Appareil à collets réglable pour cuivre et alliages légers



Ø mm - "	A mm	CHF	1	003520110
5+16 3/16+5/8	130	125.00	1	003520110

352C/U

Composition articles 334, 345SB et 352U



352C/U	CHF	1	003520110
	246.50	1	003520110

334 Ø 3+30 mm (1/8"+1"1/8)

345SB

352U Ø 5+16 mm (3/16"+5/8")

335x145x60 mm - 2120 g

353N

Pince à emboîture à tête interchangeable



L mm	CHF	1	003530201
380	491.00	1	003530201

353NM

Tête à emboîture rivetée pour 353N



Ø mm	A mm	CHF	1	003530210
10	7	167.50	1	003530210
12	10	167.50	1	003530212
14	10	167.50	1	003530214
16	12	167.50	1	003530216
18	12	167.50	1	003530218
22	13	167.50	1	003530222

353N/C6

Composition articles 353N et 353NM



353N/C6	CHF	1	003530300
	1,555.00	1	003530300

353N

353NM Ø 10-12-14-16-18-22 mm

420x185x60 mm - 2,2 kg

355

Clé étagée pour radiateurs à cinq graduations



Ø "	L mm	CHF	2	003550001
3/8"-1/2" 3/4"-1"	90	49.50	2	003550001

357F3

Gabarit à trois flacons pour l'installation de connexions sanitaires

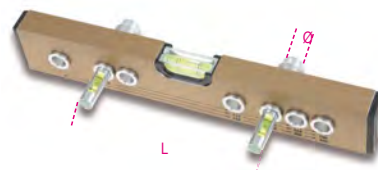

Ø "	L mm	CHF	1	003570100
3/8" / 1/2"	90÷220	157.50	1	003570100

357R/F3

Flacon pour 357F3



357R/F3	CHF	1	003570101
	25.50	1	003570101

Beta

358

Appareil pour couper et ébavurer les tubes PVC



	∅ mm	CHF		
358/1	16÷110	222.00	1	003580001
358/2	40÷250	222.00	1	003580002

358RL

Lame pour 358/1 et 358/2



	CHF		
358RL	41.00	1	003580011

359

Clé à bandes



∅ "	L mm	A mm	CHF		
1"±1/4	160	140	109.00	1	003590001

359CH

Adaptateur pour clé à bandes avec grattoir en croix pour 359



∅ "	L mm	CHF		
1"1/2	74	62.00	1	003590005

360

Clé serre-tubes modèle Stillson



L mm	∅ max "	∅ max mm	CHF		
250	1" gas	34	45.00	1	003600025
350	1"1/2 gas	49	60.00	1	003600035
450	2" gas	60	84.50	1	003600045
600	2"1/2 gas	76	129.00	1	003600060
900	3"1/2 gas	102	357.00	1	003600090

360R/...

Kit de rechange pour 360 composé de mâchoire mobile et molette.

	CHF		
360R250	17.00	1	003600225
360R350	23.30	1	003600235
360R450	33.50	1	003600245
360R600	49.50	1	003600260
360R900	89.00	1	003600290

361N

Clé serre-tubes à une main avec mâchoire mobile



L mm	∅ max "	∅ max mm	CHF		
350	1" 1/2	49	93.50	1	003610014

362

Clé serre-tubes modèle américain



L mm	∅ max "	∅ max mm	CHF		
200	1" gas	34	39.50	1	003620020
250	1"1/2 gas	49	50.00	1	003620025
300	2" gas	60	60.00	1	003620030
350	2" gas	60	72.00	1	003620035
450	2"1/2 gas	76	103.50	1	003620045
600	3" gas	90	157.00	1	003620060
900	5" gas	140	193.00	1	003620090

362R/...

Kit pièces de rechange pour 362 composé de: mâchoire fixe, mâchoire mobile, molette, goupille de retenue.

	CHF		
362R 200	8.35	1	003620220
362R 250	11.90	1	003620225
362R 300	14.80	1	003620230
362R 350	17.00	1	003620235
362R 450	23.20	1	003620245
362R 600	31.00	1	003620260
362R 900	77.50	1	003620290

363

Clé serre-tubes modèle américain en alliages légers



L mm	∅ max "	∅ max mm	CHF		
350	2" gas	60	87.00	1	003630035
450	2"1/2 gas	76	116.50	1	003630045
600	3" gas	90	197.00	1	003630060
900	5" gas	140	370.00	1	003630090
1200	6" gas	165	392.00	1	003630120

363R/...

Kit pièces de rechange pour 363 composé de: mâchoire fixe, mâchoire mobile, molette, goupille de retenue.

	CHF		
363R 350	18.60	1	003630235
363R 450	24.80	1	003630245
363R 600	34.00	1	003630260
363R 900	67.50	1	003630290
363R 1200	104.00	1	003630320

365

Clé serre-tubes prise en bout en alliages légers

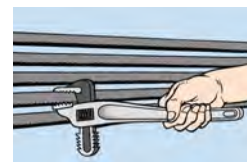

L mm	∅ max "	∅ max mm	CHF		
350	2" gas	60	108.00	1	003650035
450	2"1/2 gas	76	149.00	1	003650045

365R/...

Kit pièces de rechange pour 365 composé de: mâchoire fixe, mâchoire mobile, molette, goupille de retenue.

	CHF		
365R 350	81.00	1	003650235
365R 450	121.00	1	003650245

366

Clé étiau



L mm	∅ max "	∅ max mm	CHF		
175	1" gas	34	41.00	1	003660017
225	1"1/2 gas	49	48.50	1	003660022
275	2" gas	60	59.00	1	003660027
300	2"1/2 gas	76	64.00	1	003660030
350	3" gas	90	72.00	1	003660035

374

Clé serre-tubes modèle suédois
tête inclinée à 45°



DIN 5234

L mm	Ø max "	Ø max mm	CHF		
240	1/2" gas	21	47.00	1	003740024
320	1" gas	34	64.00	1	003740032
410	1 1/2" gas	49	83.50	1	003740041
550	2" gas	60	130.00	1	003740055
630	3" gas	90	232.50	1	003740063

375

Clé serre-tubes modèle suédois,
tête inclinée à 45°



DIN 5234

L mm	Ø max "	Ø max mm	CHF		
320	1" gas	34	64.00	1	003750032
410	1 1/2" gas	49	83.50	1	003750041
550	2" gas	60	130.00	1	003750055

376

Clé serre-tubes modèle suédois
tête inclinée à 90°



DIN 5234

L mm	Ø max "	Ø max mm	CHF		
320	1" gas	34	64.00	1	003760032
410	1 1/2" gas	49	83.50	1	003760041
550	2" gas	60	130.00	1	003760055
630	3" gas	90	236.00	1	003760063

378

Clé serre-tubes modèle suédois
tête inclinée à 45°, mâchoires fines



DIN 5234

L mm	Ø max "	Ø max mm	CHF		
250	1/2" gas	21	50.00	1	003780025
320	1" gas	34	67.00	1	003780032
410	1 1/2" gas	49	87.00	1	003780041
550	2" gas	60	143.00	1	003780055
650	3" gas	90	240.50	1	003780065

374R/...

KIT pièces de rechange complètes pour 374 -
375 - 376 - 378
composé de molette et bloque-molette

	CHF		
374R 240 x 374/240-378/250	2.83	1	003740724
374R 320 x 374/320-376/320-378/320	3.15	1	003740732
374R 410 x 374/410-375/410-376/410-378/410	3.85	1	003740741
374R 550 x 374/550-376/550-378/550	4.60	1	003740755
374R 630 x 374/630-378/650	7.00	1	003740763

383

Clé serre-tubes réversible à sangle



	CHF		
383/1 3" gas	68.00	1	003830001
383/2 8" gas	72.00	1	003830002

383R

Sangle pour 383



	CHF		
383R/1 27	27.50	1	003830010
383R/2 27	29.00	1	003830015

384

Clé serre-tubes réversible à chaîne



	CHF		
384 4" gas	92.50	1	003840032

384RC

Chaîne pour 384



	CHF		
384RC	57.00	1	003840033

386A/RC

Chaîne pour 386A



	CHF		
386A3/RC	97.50	1	003860013
386A4/RC	139.00	1	003860014
386A5/RC	184.00	1	003860015
386A6/RC	324.00	1	003860016

387

Pince à cintrer pour tubes cuivre et métaux
non ferreux
avec matrices interchangeables
3/16"-1/4"-5/16"-3/8"



L mm	Ø mm	CHF		
255	3/16"-1/4"-5/16"-3/8"	62.00	1	003870001

387R

Matrices pour 387



	CHF		
3/16"-1/4"	15.80	1	003870010
5/16"-3/8"	16.60	1	003870015

388

Pince à cintrer pour cuivre,
alliages légers et acier doux



Ø mm	L mm	R mm	CHF		
6	305	18,0	78.00	1	003880006
8	315	23,5	84.50	1	003880008
10	350	31,0	96.50	1	003880010
12	360	31,0	103.00	1	003880012
14	455	46,5	134.00	1	003880014
15	465	46,5	142.50	1	003880015
16	465	46,5	153.00	1	003880016

388A

Pince à cintrer pour tubes fins cuivre
et alliages légers



	CHF		
388A/1 6-8-10 mm	85.00	1	003880051
388A/2 1/4"-5/16"-3/8"	85.00	1	003880055

388C/C8

Cintreuse arbalète avec 7 matrices en
aluminium pour tubes fins,
cuivre recuit et alliages légers en coffret
plastique



	CHF		
388C/C8 10-12-14-16 18-20-22	618.00	1	003880200

400x330x110 mm - 3,6 kg

389/K4

kit de ressorts de cintrage de tuyaux pour tuyaux en cuivre à usage externe



∅	L mm	CHF	🔧	📦
1/4-3/8-1/2-5/8	290	26.00	1	003890001

386A

Clé serre-tubes réversible à chaîne gros effort



	∅ max	L mm	CHF	🔧	📦
386A/3	4" gas 115 mm	900	312.00	1	003860003
386A/4	6" gas 168 mm	900	579.00	1	003860004
386A/5	8" gas 220 mm	1100	746.00	1	003860005
386A/6	12" gas 324 mm	1300	1,295.00	1	003860006

392C

Pince réglable pour siphons



∅ mm	L mm	CHF	🔧	📦
25÷65	260	58.00	1	003920100

392RG/C

Paire de mors pour 392C



	CHF	🔧	📦
392RG/C	8.00	1	003920101

393

Pince pour écrous de robinet



L mm	CHF	🔧	📦
270	85.00	1	003930001

395

Clé articulée pour écrous de robinet

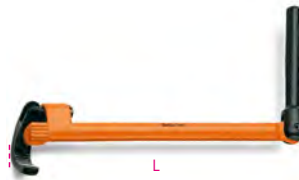

∅	L mm	CHF	🔧	📦
15÷32 mm 5/8"±1"1/4	240	56.00	1	003950001

395T

Clé articulée télescopique pour écrous de robinet



∅	L mm	CHF	🔧	📦
10÷32 mm 3/8"±1"1/4	250÷430	75.00	1	003950100

398

Étau à chaîne pour établi



∅	L mm	CHF	🔧	📦
1/2÷8"	250	386.00	1	003980008

399

Étau pour tubes

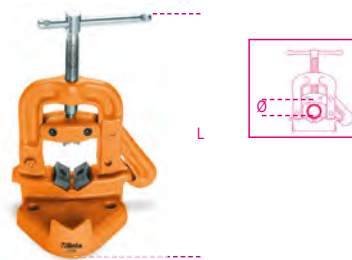

∅	L min mm	CHF	🔧	📦
10÷60 mm 1/8÷2"	220	237.00	1	003990005
10÷89 mm 1/8÷3"	290	425.00	1	003990010

399R/...

Kit de rechange pour 399 composé de deux mâchoires inférieures et une supérieure



	CHF	🔧	📦
399RG1/8-2"	30.50	1	003990105
399RG1/8-3"	49.00	1	003990110

TABLEAU POUR FORÊTS À MÉTAL TWIST

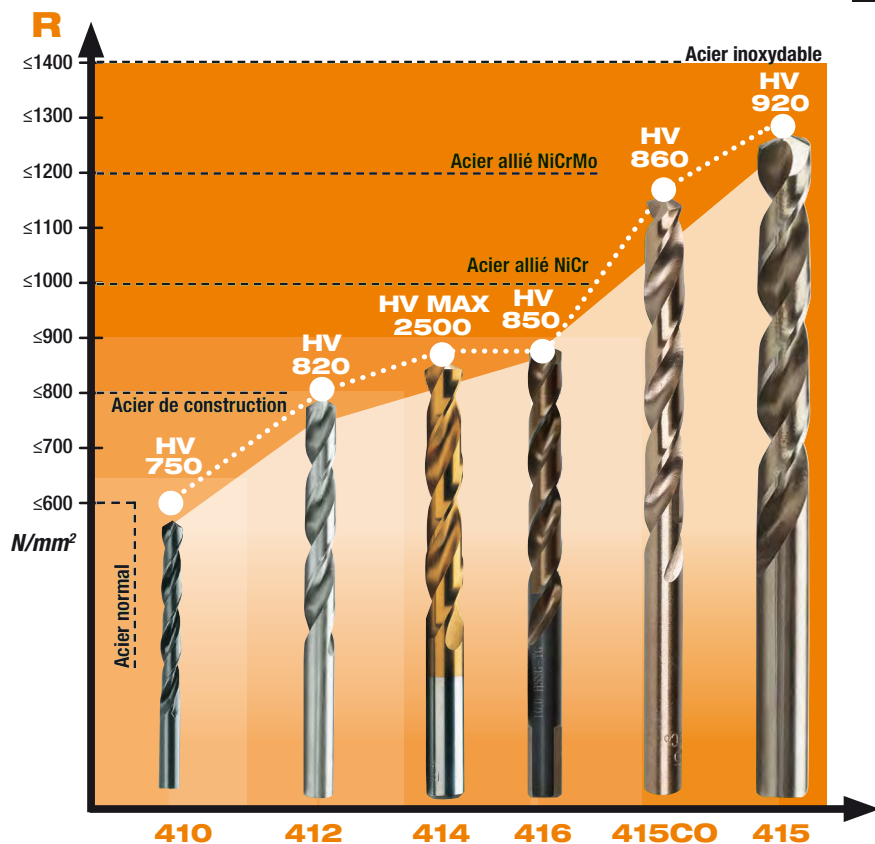

R N/mm² - C'est la résistance mécanique du matériau à percer.

HV - C'est la dureté du foret hélicoïdal selon l'échelle Vickers (plus la valeur est élevée, plus la dureté du matériau est élevée)

GUIDE DES FORÊTS DE PERÇAGE A EMMENAGEMENT CYLINDRIQUE

Forêts hélicoïdaux laminés – Les Forêts hélicoïdaux laminés sont obtenus à partir d'un procédé de fabrication par laminage à chaud. Ils sont de bonne qualité, et s'utilisent pour des travaux légers, (exemples : perçage du fer, de l'acier doux, des alliages légers et des métaux non ferreux).

Forêts hélicoïdaux rectifiés – Les Forêts hélicoïdaux rectifiés sont obtenus à partir d'une barre d'acier traitée thermiquement. Ils sont utilisés pour des applications demandant des prestations hautes performances, comme le perçage de l'acier et des alliages légers. Ils sont d'une efficacité constante avec une évacuation des copeaux et une précision de perçage excellente.

HSS – L'Acier HSS est extrêmement dur et résistant aux hautes températures, ils est destinés aux outils de coupe, de taraudage et de filetage.

Cobalt (Co) – Le Cobalt est un matériau qui offre à l'acier une meilleure résistance à la chaleur et à l'usure (par exemple l'utilisation des forêts hélicoïdaux à hautes températures). Plus la teneur en cobalt est élevée, meilleures sont les performances de l'outil. Les alliages les plus couramment utilisés ont une teneur en cobalt de 5% ou 8%.

HSS-Co – L'Acier HSS-Co possède une teneur en cobalt de 5% ou 8%.

TiN – Le revêtement ultrafin en nitrure de titane est utilisé pour sa dureté élevée et son faible facteur de friction, il permet une meilleure élimination des copeaux et offre une résistance accrue à l'usure et à l'oxydation.

Acier au chrome – Les outils en acier au chrome sont utilisés pour une utilisation manuelle comme le filetage sur du fer, des alliages légers, de l'acier non traité et de l'acier traité thermiquement à faible dureté. Ils sont largement utilisés pour le nettoyage et la réparation des filetages endommagés dans tous les travaux professionnels, industriel ou automobile.

Métal dur – Matériau à haute résistance à l'usure, utilisé dans les plaquettes des pointes des forêts à béton.

Affûtage à 118° - C'est l'angle d'affûtage standard des forêts hélicoïdaux pour métal. Il permet un perçage rapide, un centrage plus facile et une excellente dissipation de la chaleur dans les métaux.

Affûtage à 130° - C'est l'angle d'affûtage permettant d'offrir plus de précision dans les premières opérations de perçage et nécessitant moins de force de perçage.

Double affûtage à 115°/135° – Ce double affûtage permet de combiner les avantages des deux angles, et possède une fonction « brise-copeaux », il est le meilleur choix pour les matériaux à copeaux longs.

SDS-Plus – Fixation rapide et sûre pour perforateurs et burineurs.

410

Foret laminé en acier HSS, série courte

R ≤ 650 N/mm²
HV ~ 750÷820



DIN 338 ISO 235

Ø mm	L mm	L1 mm	CHF	📦	🏠
0,50	22	6	2.04	10	004100030
1,00	34	12	1.13	10	004100040
1,25	38	16	0.93	10	004100043
1,50	40	18	0.87	10	004100046
1,75	46	22	0.87	10	004100049
2,00	49	24	0.80	10	004100052
2,25	53	27	0.93	10	004100055
2,50	57	30	0.87	10	004100058
2,75	61	33	0.93	10	004100061
3,00	61	33	0.87	10	004100064
3,20	65	36	1.18	10	004100066
3,25	65	36	1.18	10	004100067
3,50	70	39	1.11	10	004100070
3,75	70	39	1.33	10	004100073
4,00	75	43	1.22	10	004100076
4,20	75	43	1.53	10	004100078
4,25	75	43	1.53	10	004100079
4,50	80	47	1.37	10	004100082
4,75	80	47	1.58	10	004100085
5,00	86	52	1.51	10	004100088
5,25	86	52	2.14	10	004100091
5,50	93	57	2.00	10	004100094
5,75	93	57	2.19	10	004100097
6,00	93	57	2.00	10	004100100
6,25	101	63	2.61	10	004100103
6,50	101	63	2.46	10	004100106
6,75	109	69	3.15	10	004100109
7,00	109	69	2.91	10	004100112
7,50	109	69	3.05	10	004100118
8,00	117	75	3.60	10	004100124
8,50	117	75	3.80	10	004100130
9,00	125	81	4.60	5	004100136
9,50	125	81	5.10	5	004100142
10,00	133	87	5.60	5	004100148
10,50	133	87	6.70	5	004100172
11,00	142	94	7.95	5	004100184
11,50	142	94	8.25	5	004100196
12,00	151	101	9.10	5	004100210
12,50	151	101	10.00	5	004100222
13,00	151	101	10.50	5	004100234
14,00	160	108	14.00	5	004100242
15,00	169	114	16.40	5	004100250
16,00	178	120	20.30	5	004100258
17,00	184	125	22.50	3	004100262
18,00	191	130	26.50	3	004100266
19,00	198	135	30.00	3	004100270
20,00	205	140	36.00	3	004100274



	CHF	📦	🏠
410/SP19 Ø 1÷10 x 0,5 mm	58.00	1	004100419
410/SPVP1	32.00	1	004100421
410/SP25 Ø 1÷13 x 0,5 mm	122.50	1	004100425
410/SPVP2	44.50	1	004100427



410/SEL19 CHF 45.00 1 004100418
 Ø 1=10 x 0,5 mm

410MIX/SEL19

Jeu de 13 forets 410 et 6 forets avec mise rapportée en métal dur



410MIX/SEL19 CHF 45.00 1 004100417

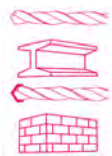

Ø 1 - 1,5 - 2 - 2,5 - 3 - 3,5 - 4
 4,5 - 5 - 5,5 - 6 - 8 - 10 mm

Ø 4 - 5 - 6 - 8 - 9 - 10 mm

410A

Foret laminé en acier HSS, série courte, avec support réduit

R ≤ 650 N/mm²
 HV ~ 750+820



DIN 338 ISO 235

Ø mm	L mm	L1 mm	CHF	Icon	Code
13,50	160	108	16.50	5	004100281
14,00	160	108	16.50	5	004100283
14,50	169	114	19.10	5	004100285
15,00	169	114	19.10	5	004100287
15,50	178	120	23.70	5	004100289
16,00	178	120	23.70	5	004100291
16,50	184	125	24.90	3	004100292
17,00	184	125	24.90	3	004100293
17,50	191	130	29.50	3	004100294
18,00	191	130	29.50	3	004100295
18,50	198	135	33.00	3	004100296
19,00	198	135	33.00	3	004100297
19,50	205	140	38.50	3	004100298
20,00	205	140	38.50	3	004100299

410AS

Foret laminé en acier HSS, série courte, en pouces

R ≤ 650 N/mm²
 HV ~ 750+820



ANSI B94

Ø "	L mm	L1 mm	CHF	Icon	Code
1/16	48	22	0.80	10	004100371
5/64	51	25	0.87	10	004100372
3/32	57	32	0.98	10	004100373
7/64	67	38	1.11	10	004100374
1/8	70	41	1.21	10	004100375
9/64	73	44	1.31	10	004100376
5/32	79	51	1.39	10	004100377
11/64	83	54	1.58	10	004100378
3/16	89	59	1.82	10	004100379
13/64	92	62	1.88	10	004100380
7/32	95	64	2.04	10	004100381
15/64	98	67	2.40	10	004100382
1/4	102	70	2.70	10	004100383
17/64	105	73	3.15	10	004100384
9/32	108	75	3.50	10	004100385
19/64	111	78	3.85	10	004100386
5/16	114	81	4.90	10	004100387
21/64	117	84	5.10	10	004100388
11/32	121	87	5.90	5	004100389
23/64	124	89	6.00	5	004100390
3/8	127	92	6.35	5	004100391



410AS/SP21 CHF 88.00 1 004100429

Ø 1/16-5/64-3/32-7/64
 1/8-9/64-5/32-11/64-3/16
 13/64-7/32-15/64-1/4
 17/64-9/32-19/64-5/16
 21/64-11/32-23/64-3/8

410AS/SPV1 33.00 1 004100430



410AS/SEL21 CHF 70.00 1 004100433

Ø 1/16-5/64-3/32-7/64
 1/8-9/64-5/32-11/64-3/16
 13/64-7/32-15/64-1/4
 17/64-9/32-19/64-5/16
 21/64-11/32-23/64-3/8

412

Foret taillé en acier HSS, rectifié poli, série courte

R ≤ 800 N/mm²
 HV ~ 750+820



DIN 338 ISO 235

Ø mm	L mm	L1 mm	CHF	Icon	Code
0,50	22	6	3.55	10	004120030
1,00	34	12	2.27	10	004120040
1,25	38	16	2.44	10	004120043
1,50	40	18	2.04	10	004120046
1,75	46	22	2.04	10	004120049
2,00	49	24	1.73	10	004120052
2,25	53	27	2.19	10	004120055
2,50	57	30	1.88	10	004120058
2,75	61	33	2.19	10	004120061
3,00	61	33	1.98	10	004120064
3,25	65	36	2.58	10	004120067
3,50	70	39	2.37	10	004120070
3,75	70	39	2.83	10	004120073
4,00	75	43	2.58	10	004120076
4,25	75	43	3.30	10	004120079
4,50	80	47	2.97	10	004120082
4,75	80	47	3.55	10	004120085
5,00	86	52	3.30	10	004120088
5,25	86	52	4.65	10	004120091
5,50	93	57	4.30	10	004120094
5,75	93	57	5.20	10	004120097
6,00	93	57	4.45	10	004120100
6,25	101	63	6.50	10	004120103
6,50	101	63	5.70	10	004120106
6,75	109	69	7.30	10	004120109
7,00	109	69	6.70	10	004120112
7,25	109	69	8.20	5	004120115
7,50	109	69	6.95	5	004120118
7,75	117	75	9.30	5	004120121
8,00	117	75	8.55	5	004120124
8,25	117	75	10.40	5	004120127
8,50	117	75	10.50	5	004120130
8,75	125	81	11.50	5	004120133
9,00	125	81	10.90	5	004120136
9,25	125	81	12.70	5	004120139
9,50	125	81	11.40	5	004120142
9,75	133	87	14.10	5	004120145
10,00	133	87	12.70	5	004120148
10,25	133	87	19.20	5	004120149
10,50	133	87	17.00	5	004120150
10,75	142	94	23.10	5	004120151
11,00	142	94	20.20	5	004120152
11,25	142	94	24.60	5	004120153
11,50	142	94	21.30	5	004120154
11,75	142	94	26.50	5	004120155
12,00	151	101	23.40	5	004120156
12,25	151	101	29.00	5	004120157
12,50	151	101	25.00	5	004120158
12,75	151	101	33.00	5	004120159
13,00	151	101	26.50	5	004120160



412/SP19 CHF 116.00 1 004120419
 Ø 1÷10 x 0,5 mm

410/SPVP1 32.00 1 004100421

412/SP25 240.50 1 004120425
 Ø 1÷13 x 0,5 mm

410/SPVP2 44.50 1 004100427

412/SP49 577.00 1 004120449
 Ø 1÷13 x 0,25 mm

412/SPV4 137.00 1 004120451



412/C150



412/C150 CHF 699.00 1 004120450

412	Ø 3 mm	n.
	Ø 1 - 1,5 - 2 - 2,5 - 3 - 3,5 - 4 - 4,5 - 5 mm	20
	Ø 5,5 - 6 - 6,5 - 7 - 7,5 - 8 - 8,5 - 9 - 9,5 - 10 mm	10

365x230x47 mm - 3,3 kg



412/SP91 CHF 749.00 1 004120452

Ø 1=10 x 0,10 mm

412A

Foret taillé en acier HSS, série courte, rectifié bruni, avec support réduit

R ≤ 800 N/mm²
HV ~ 750÷820



DIN 338 ISO 235

Ø mm	L mm	L1 mm	CHF	1	004120202
13,50	160	108	42.50	3	004120202
14,00	160	108	44.00	3	004120204
14,50	169	114	47.00	3	004120206
15,00	169	114	49.50	3	004120208
15,50	178	120	57.00	3	004120210
16,00	178	120	59.00	3	004120212
16,50	184	125	60.50	1	004120213
17,00	184	125	65.00	1	004120214
17,50	191	130	69.50	1	004120215
18,00	191	130	73.50	1	004120216
18,50	198	135	79.50	1	004120217
19,00	198	135	82.00	1	004120218
19,50	205	140	91.50	1	004120219
20,00	205	140	93.00	1	004120220

412C

Foret taillé en acier HSS, rectifié bruni, série extra courte

R ≤ 800 N/mm²
HV ~ 750÷820



DIN 1897 ISO 235

Ø mm	L mm	L1 mm	CHF	10	004120288
3,00	46	16	1.98	10	004120288
3,25	49	18	2.19	10	004120289
3,50	52	20	2.19	10	004120290
4,00	55	22	2.44	10	004120292
4,50	58	24	2.76	10	004120294
5,00	62	26	2.83	10	004120296
5,50	66	28	3.80	10	004120298
6,00	66	28	4.20	10	004120300
6,5	70	31	4.95	10	004120301
7,00	74	34	5.90	10	004120302
7,5	74	34	6.35	5	004120303
8,00	79	37	7.75	5	004120304

412L

Foret taillé en acier HSS, rectifié bruni, série longue

R ≤ 800 N/mm²
HV ~ 750÷820



DIN 340

Ø mm	L mm	L1 mm	CHF	10	004120232
2,00	85	56	4.65	10	004120232
2,50	95	62	4.95	10	004120234
3,00	100	66	5.20	10	004120236
3,50	112	73	5.95	10	004120238
4,00	119	78	6.50	10	004120240
4,50	126	82	7.90	10	004120242
5,00	132	87	8.20	10	004120244
5,50	139	91	10.40	10	004120246
6,00	139	91	11.10	10	004120248
6,50	148	97	13.30	5	004120250
7,00	156	102	15.50	5	004120252
8,00	165	109	20.60	5	004120256
9,00	175	115	24.30	5	004120260
10,00	184	121	26.50	5	004120264

412XL

Foret taillé en acier HSS, rectifié, série extra-longue

R ≤ 800 N/mm²
HV ~ 750÷820



DIN 1869/1

Ø mm	L mm	L1 mm	CHF	1	004120520
3,00	150	100	18.00	1	004120520
3,50	165	115	19.70	1	004120522
4,00	175	120	19.70	1	004120524
4,50	185	125	20.30	1	004120526
5,00	195	135	20.30	1	004120528
5,50	205	140	25.00	1	004120530
6,00	205	140	25.00	1	004120532

Ø mm	L mm	L1 mm	CHF	1	004120534
6,50	215	150	29.50	1	004120534
7,00	225	155	34.00	1	004120536
7,50	225	155	39.50	1	004120538
8,00	240	165	42.00	1	004120540
8,50	240	165	44.00	1	004120542
9,00	250	175	56.50	1	004120544
9,50	250	175	60.50	1	004120546
10,00	265	185	60.50	1	004120548
10,50	265	185	60.50	1	004120550
11,00	280	195	60.50	1	004120552
12,00	295	205	77.50	1	004120556
13,00	295	205	80.50	1	004120560

414

Foret taillé en acier HSS-TiN, rectifié, série courte

R ≤ 900 N/mm²
HV 0,05 ~ 2500



DIN 338 ISO 235

Ø mm	L mm	L1 mm	CHF	10	004140040
1,00	34	12	3.10	10	004140040
1,25	38	16	3.55	10	004140042
1,50	40	18	2.76	10	004140046
1,75	46	22	3.55	10	004140048
2,00	49	24	2.91	10	004140052
2,25	53	27	3.60	10	004140054
2,50	57	30	3.05	10	004140058
2,75	61	33	4.15	10	004140060
3,00	61	33	3.45	10	004140064
3,25	65	36	4.40	10	004140066
3,50	70	39	4.15	10	004140070
3,75	70	39	4.60	10	004140072
4,00	75	43	4.15	10	004140076
4,25	75	43	5.10	10	004140078
4,50	80	47	4.60	10	004140082
4,75	80	47	5.75	10	004140084
5,00	86	52	5.40	10	004140088
5,25	86	52	7.50	10	004140090
5,50	93	57	6.45	10	004140094
5,75	93	57	7.90	10	004140096
6,00	93	57	7.20	10	004140100
6,25	101	63	9.10	10	004140102
6,50	101	63	8.00	10	004140106
6,75	109	69	10.90	10	004140108
7,00	109	69	8.80	10	004140112
7,25	109	69	12.10	5	004140114
7,50	109	69	10.80	5	004140118
7,75	117	75	14.10	5	004140120
8,00	117	75	12.70	5	004140124
8,25	117	75	14.80	5	004140125
8,50	117	75	13.20	5	004140130
8,75	125	81	18.40	5	004140132
9,00	125	81	16.40	5	004140136
9,25	125	81	20.80	5	004140138
9,50	125	81	18.40	5	004140142
9,75	133	87	21.80	5	004140144
10,00	133	87	19.40	5	004140148
10,50	133	87	22.70	5	004140150
11,00	142	94	24.60	5	004140152
11,50	142	94	26.50	5	004140154
12,00	151	101	28.50	5	004140156
12,50	151	101	33.00	5	004140158
13,00	151	101	34.00	5	004140160





	CHF		
414/SP19 Ø 1÷10 x 0,5 mm	170.00	1	004140419
410/SPVP1	32.00	1	004100421
414/SP25 Ø 1÷13 x 0,5 mm	343.00	1	004140425
410/SPVP2	44.50	1	004100427
414/SP49 Ø 1÷13 x 0,25 mm	756.00	1	004140429
414/SPV4	137.00	1	004140430

414/C116



	CHF		
414/C116	689.00	1	004140450

414	Ø 1 - 1,5 - 2 - 2,5 - 3 - 3,5 - 4 - 4,5 - 5 mm	n.
	Ø 5,5 - 6 - 6,5 - 7 - 7,5 - 8 mm	3
	Ø 8,5 - 9 - 9,5 - 10 mm	2

365x230x47 mm - 2,7 Kg

415

Foret taillé en acier HSS-CO 8% rectifié, série courte

R ≤ 1400 N/mm²
HV ~ 850+920

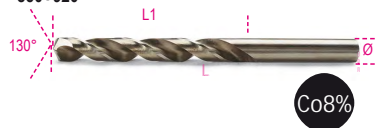

DIN 338 ISO 235

Ø mm	L mm	L1 mm	CHF		
0,50	22	6	8.70	10	004150029
1,00	34	12	4.30	10	004150040
1,25	38	16	4.70	10	004150043
1,50	40	18	4.30	10	004150046
1,75	46	22	4.45	10	004150049
2,00	49	24	4.15	10	004150052
2,25	53	27	5.10	10	004150055
2,50	57	30	4.60	10	004150058
2,75	61	33	5.10	10	004150061
3,00	61	33	4.65	10	004150064
3,25	65	36	6.45	10	004150067
3,50	70	39	5.90	10	004150070
3,75	70	39	7.20	10	004150073
4,00	75	43	6.45	10	004150076
4,25	75	43	8.05	10	004150079
4,50	80	47	7.30	10	004150082
4,75	80	47	8.45	10	004150085
5,00	86	52	7.90	10	004150088

Ø mm	L mm	L1 mm	CHF		
5,25	86	52	11.40	10	004150091
5,50	93	57	10.40	10	004150094
5,75	93	57	12.00	10	004150097
6,00	93	57	10.90	10	004150100
6,25	101	63	15.50	10	004150103
6,50	101	63	13.50	10	004150106
6,75	109	69	17.90	10	004150109
7,00	109	69	16.00	10	004150112
7,25	109	69	19.20	5	004150115
7,50	109	69	17.40	5	004150118
7,75	117	75	22.60	5	004150121
8,00	117	75	20.30	5	004150124
8,25	117	75	24.60	5	004150127
8,50	117	75	23.10	5	004150130
8,75	125	81	30.50	5	004150133
9,00	125	81	27.00	5	004150136
9,25	125	81	31.50	5	004150139
9,50	125	81	29.00	5	004150142
9,75	133	87	34.00	5	004150145
10,00	133	87	31.50	5	004150148
10,25	133	87	41.00	5	004150149
10,50	133	87	34.50	5	004150150
10,75	142	94	45.00	5	004150151
11,00	142	94	41.00	5	004150152
11,25	142	94	51.00	5	004150153
11,50	142	94	44.50	5	004150154
11,75	142	94	52.00	5	004150155
12,00	151	101	48.50	5	004150156
12,25	151	101	62.00	5	004150157
12,50	151	101	52.00	5	004150158
12,75	151	101	68.00	5	004150159
13,00	151	101	56.00	5	004150160
14,00	160	108	98.00	3	004150164
15,00	169	114	116.00	3	004150168
16,00	178	120	142.50	3	004150172
17,00	186	125	162.00	1	004150174
18,00	194	130	180.00	1	004150176
19,00	202	135	207.00	1	004150178
20,00	210	140	232.50	1	004150180



Co8%

	CHF		
415/SP19 Ø 1÷10 x 0,5 mm	238.50	1	004150419
410/SPVP1	32.00	1	004100421
415/SP25 Ø 1÷13 x 0,5 mm	495.00	1	004150425
410/SPVP2	44.50	1	004100427
415/SP49 Ø 1÷13 x 0,25 mm	1,230.00	1	004150431
415/SPV4	137.00	1	004150432

415/C116



	CHF		
415/C116	1,040.00	1	004150450

415	Ø 1 - 1,5 - 2 - 2,5 - 3 - 3,5 - 4 - 4,5 - 5 mm	n.
	Ø 5,5 - 6 - 6,5 - 7 - 7,5 - 8 mm	3
	Ø 8,5 - 9 - 9,5 - 10 mm	2

365x230x47 mm - 2,7 kg



	CHF		
415/SP91 Ø 1÷10 x 0,10 mm	1,430.00	1	004150460

415CO

Foret taillé en acier HSS-CO 5 %, rectifié, série courte

R ≤ 1200 N/mm²
HV ~ 800+860



DIN 338 ISO 235

Ø mm	L mm	L1 mm	CHF		
1,00	34	12	2.19	10	004150310
1,50	40	18	2.19	10	004150312
2,00	49	24	2.19	10	004150314
2,50	57	30	2.27	10	004150316
3,00	61	33	2.27	10	004150320
3,50	70	39	2.83	10	004150322
4,00	75	43	3.30	10	004150324
4,50	80	47	3.80	10	004150326
5,00	86	52	3.90	10	004150328
5,50	93	57	4.95	10	004150330
6,00	93	57	5.50	10	004150332
6,50	101	63	6.60	10	004150334
7,00	109	69	8.15	10	004150336
7,50	109	69	8.85	5	004150338
8,00	117	75	10.50	5	004150340
8,50	117	75	10.90	5	004150342
9,00	125	81	13.40	5	004150344
9,50	125	81	14.10	5	004150346
10,00	133	87	16.40	5	004150348
10,50	133	87	19.70	5	004150350
11,00	142	94	21.80	5	004150352
11,50	142	94	24.10	5	004150354
12,00	151	101	26.00	5	004150356
12,50	151	101	28.50	5	004150358
13,00	151	101	31.00	5	004150360

415CO-A

Foret taillé en acier HSS-CO 5 %, rectifié, série courte

R ≤ 1200 N/mm²
HV ~ 800+860



DIN 338

Ø mm	L mm	L1 mm	CHF		
14,00	160	108	60.50	3	004150364
15,00	169	114	70.00	3	004150366
16,00	178	120	85.00	3	004150368
17,00	184	125	87.00	1	004150370
18,00	191	130	111.00	1	004150372
19,00	198	135	128.50	1	004150374
20,00	205	140	148.00	1	004150376



Co5%

DIN 338

415CO/SP19	CHF 125.00	1	004150421
Ø 1÷10 x 0,5 mm			
410/SPVP1	32.00	1	004100421

415C

Foret taillé en acier HSS-CO 5 %, rectifié, série extra courte

R ≤ 1200 N/mm²
HV ~ 800÷860



Co5%

DIN 1897 ISO 235

Ø mm	L mm	L1 mm	CHF		
3,00	46	16	3.05	10	004150288
3,25	49	18	3.90	10	004150289
3,50	52	20	3.90	10	004150290
4,00	55	22	4.30	10	004150292
4,50	58	24	4.90	10	004150294
5,00	62	26	5.25	10	004150296
5,50	66	28	6.95	10	004150298
6,00	66	28	7.45	10	004150300
6,50	70	31	7.75	10	004150301
7,00	74	34	9.25	10	004150302
7,50	74	34	10.70	5	004150303
8,00	79	37	13.20	5	004150304

415L

Foret taillé en acier HSS-CO 5 %, rectifié, série longue

R ≤ 1200 N/mm²
HV ~ 800÷860



Co5%

DIN 340

Ø mm	L mm	L1 mm	CHF		
3,00	100	66	5.95	10	004150236
3,50	112	73	6.60	10	004150238
4,00	119	78	8.15	10	004150240
4,50	126	82	9.90	10	004150242
5,00	132	87	10.40	10	004150244
5,50	139	91	12.90	10	004150246
6,00	139	91	14.10	10	004150248
6,50	148	97	16.60	5	004150250
7,00	156	102	19.70	5	004150252
8,00	165	109	25.00	5	004150256
9,00	175	115	31.00	5	004150260
10,00	184	121	40.50	5	004150264

416

Foret cylindrique avec affûtage spécial à double paire de tranchants

R ≤ 900 N/mm²
HV ~ 820÷850



VITESSE DE COUPE SUPÉRIEURE



DIN 338

Ø mm	L mm	L1 mm	CHF		
1,00	34	12	3.35	10	004160010
1,50	40	18	3.35	10	004160015
2,00	49	24	3.35	10	004160020
2,50	57	30	3.55	10	004160025
3,00	61	33	3.80	10	004160030
3,50	70	39	4.20	10	004160035
4,00	75	43	4.65	10	004160040
4,50	80	47	5.20	10	004160045
5,00	86	52	5.90	10	004160050
5,50	93	57	7.65	10	004160055
6,00	93	57	8.15	10	004160060
6,50	101	63	9.60	10	004160065
7,00	109	69	11.10	10	004160070
7,50	109	69	12.00	5	004160075
8,00	117	75	14.30	5	004160080
8,50	117	75	15.50	5	004160085
9,00	125	81	18.10	5	004160090
9,50	125	81	19.40	5	004160095
10,00	133	87	22.30	5	004160100

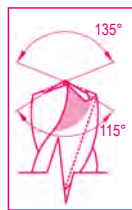

416/SP19	CHF 168.50	1	004160419
Ø 1÷10 x 0,5 mm			
410/SPVP1	32.00	1	004100421

417

Foret béton en acier fraisé, avec plaquette en métal dur



DIN 8039

Ø mm	L mm	CHF		
3	70	4.45	10	004170003
4	75	4.45	10	004170004
5	85	4.70	10	004170005
5L	150	10.70	5	004170105
6	100	4.90	10	004170007
6L	150	10.70	5	004170106
7	120	5.50	10	004170009
8	120	6.10	10	004170010
8L	200	11.50	5	004170113
9	120	6.90	10	004170011
10	120	8.05	10	004170012
10L	200	13.90	5	004170120
12	150	10.50	10	004170014
12L	200	15.10	5	004170125
14	150	14.60	5	004170016
16	150	18.10	5	004170018



417/SP8	CHF 68.00	1	004170100
Ø 3-4-5-6-8-9-10-12 mm			

419

Foret pour marteau perforateur, corps fraisé avec plaquette en métal dur
HVA~ 1650



DIN 8039

Ø mm	L mm	CHF		
4	110	9.25	10	004190002
5	110	9.25	10	004190004
5	160	10.20	10	004190006
6	110	9.05	10	004190012
6	160	9.90	10	004190014
6	210	13.30	10	004190016
7	160	10.90	10	004190028
8	110	9.75	10	004190030
8	160	10.50	10	004190032
8	210	12.70	10	004190034
8	260	17.20	10	004190036
8	310	21.10	10	004190038
8	460	38.50	10	004190042
9	160	12.90	5	004190044
10	160	13.30	5	004190050
10	210	15.40	5	004190052
10	260	19.10	5	004190054
10	310	27.00	5	004190056
10	460	42.00	5	004190060
12	160	14.80	5	004190064
12	210	20.00	5	004190066
12	260	21.50	5	004190068
12	460	44.00	5	004190074
14	160	20.30	3	004190086
14	260	24.60	3	004190090
14	310	34.50	3	004190092
14	460	45.00	3	004190096
16	210	30.00	3	004190112
16	250	31.50	3	004190114
16	300	38.50	3	004190116
16	450	51.00	3	004190120
18	250	41.00	1	004190124
20	310	41.00	1	004190128



419T

Foret pour marteau perforateur, corps fraisé à 4 hélices et 4 dents, support SDS Plus
HVA- 1650

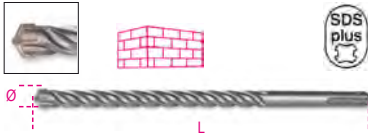

Ø mm	L mm	CHF		
5	110	6.25	5	004190604
5	160	7.00	5	004190606
6	110	6.60	5	004190612
6	160	7.75	5	004190614
6	210	10.50	5	004190616
7	160	7.90	5	004190628
8	110	7.20	5	004190630
8	160	8.15	5	004190632
8	210	10.80	5	004190634
8	260	12.30	5	004190636
8	310	15.10	5	004190638
9	160	8.60	3	004190644
10	160	8.70	3	004190650
10	210	11.50	3	004190652
10	260	12.50	3	004190654
10	310	18.00	3	004190656
10	460	24.30	3	004190660
12	160	9.70	3	004190664
12	210	12.70	3	004190666
12	260	13.40	3	004190668
12	460	25.00	3	004190674
14	160	13.20	2	004190686
14	260	15.40	2	004190690
14	310	21.70	2	004190692
14	460	24.30	2	004190696
16	210	17.50	2	004190712
16	260	23.10	2	004190714
16	310	24.90	2	004190716
16	460	26.00	2	004190720
18	260	28.00	1	004190724
20	310	34.00	1	004190728

420A

Foret étagé à hélices indépendantes pour perçages vis 90°, en acier HSS, pour trous débouchants

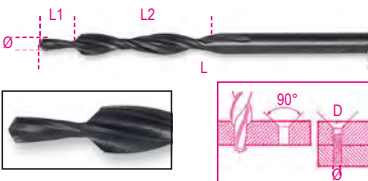

DIN 8374

M	Ø mm	D mm	L1 mm	L2 mm	L mm	CHF		
3	3,2	6	9,00	57,00	93,00	65.50	1	004200003
4	4,3	8	11,00	75,00	117,00	76.00	1	004200004
5	5,3	10	13,00	87,00	133,00	95.50	1	004200005
6	6,4	11,5	15,00	94,00	142,00	109.50	1	004200006
8	8,4	15	19,00	114,00	169,00	186.00	1	004200008
10	10,5	19	23,00	135,00	198,00	288.00	1	004200010

420B

Foret étagé à hélices indépendantes pour perçages vis 180°, en acier HSS, pour trous débouchants

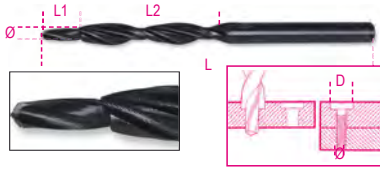

DIN 8376

M	Ø mm	D mm	L1 mm	L2 mm	L mm	CHF		
3	3,4	6	9,00	57,00	93,00	57.50	1	004200053
4	4,5	8	11,00	75,00	117,00	65.00	1	004200054
5	5,5	10	13,00	87,00	133,00	80.00	1	004200055
6	6,6	11	15,00	94,00	142,00	93.00	1	004200056
8	9	15	19,00	114,00	169,00	117.00	1	004200058
10	11	18	23,00	130,00	191,00	175.00	1	004200060

421

Fraise à noyer pour têtes de vis cylindriques avec guide de centrage en acier HS

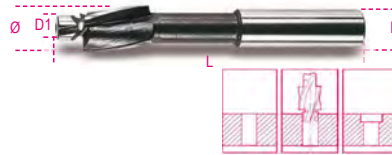

DIN 373

M	L mm	Ø mm	D1 mm	D mm	CHF		
3	71	6	3,2	5	33.50	1	004210003
4	71	8	4,3	5	33.50	1	004210004
5	80	10	5,3	8	33.50	1	004210005
6	80	11	6,4	8	34.00	1	004210006
8	100	15	8,4	12,5	56.00	1	004210008
10	100	18	10,5	12,5	66.50	1	004210010
12	100	20	13,0	12,5	72.00	1	004210012



	CHF		
421/SP6 M 3-4-5-6-8-10	274.00	1	004210019
421/SPV	20.30	1	004210020

422

Foret à centrer rectifié avec angle de taraudage de 60° en acier HSS

• Exécution rapide et sûre des trous de centrage



DIN 333/A

Ø mm	D mm	L mm	CHF		
1,60	4,0	35,5	10.70	1	004220116
2,50	6,3	45,0	12.20	1	004220125
3,15	8,0	50,0	13.80	1	004220131

423

Foret à dépointer en acier HSS, rectifié



Ø mm	L mm	CHF		
6	66	21.10	5	004230006
7	74	26.00	5	004230007
8	79	28.00	5	004230008
10	89	33.00	5	004230010

423A

Fraise à dépointer en acier HSS, rectifié



DIN 1412/E

Ø mm	L mm	CHF		
6,5	40	30.50	1	004230015
8,0	40	33.50	1	004230020

424

Foret conique en acier HSS

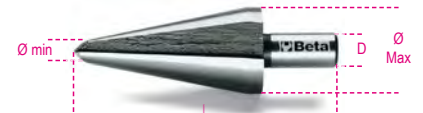

	L mm	Ø mm	D mm	CHF		
424/1	58	3÷14	6	38.50	2	004240001
424/2	63	6÷20	8	64.50	2	004240002
424/3	60	16÷30	10	111.00	2	004240003
424/4	80	3÷22	8	135.50	1	004240004
424/5	102	3÷31	10	183.00	1	004240005
424/6	86	26÷40	13	232.50	1	004240006
424/7	89	36÷50	13	348.00	1	004240007
424/8	90	40÷61	13	577.00	1	004240008



	CHF		
424/SP3 424/1+424/2+424/3 Ø 3÷30 mm	222.00	1	004240019
424/SPV	30.50	1	004240020

425

Foret conique étagé en acier HSS

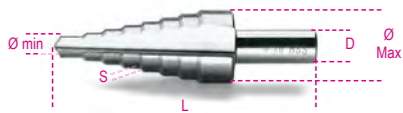

L	Ø	S	D	CHF		
mm	mm	mm	mm			
425/1	70	4+12	1 6	65.00	2	004250010
425/2	55	4+12	2 6	69.00	2	004250012
425/3	85	4+20	2 10	100.50	2	004250015
425/4	85	12+20	1 10	153.00	1	004250016
425/5	97	20+30	1 10	301.00	1	004250017
425/6	75	4+30	2 10	209.50	1	004250020
425/7	97	30+40	1 13	418.00	1	004250025
425/8	100	40+50	1 13	582.00	1	004250029



	CHF		
425/SP3	382.00	1	004250030
425/1+425/3+425/6			
Ø 4+30 mm			
425/SPV	30.50	1	004250035

426

Fraise à noyer à 3 dents en acier HSS



DIN 335-C

GR	Ø	L	Ø1	CHF		
	mm	mm	mm			
1	4,3	44	4	21.80	3	004260001
2	5,3	44	4	21.80	3	004260002
3	6,3	44	5	22.70	3	004260003
4	7,3	44	6	26.50	3	004260004
5	8,3	50	6	26.50	3	004260005
6	9,4	50	6	29.50	3	004260006
7	10,4	54	6	33.50	3	004260007
8	12,4	54	8	36.00	3	004260008
9	15,0	56	10	40.50	3	004260009
10	16,5	60	10	42.50	3	004260010
11	20,5	63	10	59.00	3	004260011
12	25,0	66	10	93.00	3	004260012
13	28,0	71	12	125.00	3	004260013
14	31,0	71	12	132.50	3	004260014



DIN 335-C

	CHF		
426/SP6	233.00	1	004260030
GR 3-5-7-8-10-11			
Ø 6,3+20,5 mm			
426/SPV	30.50	1	004260035

426T

fraise à noyer à 3 dents en acier HSS + TiN



DIN 335-C

GR	Ø	L	Ø1	CHF		
	mm	mm	mm			
1	4,3	44	4	28.00	3	004260061
2	5,3	44	4	28.00	3	004260062
3	6,3	44	5	29.00	3	004260063
4	7,3	44	6	33.00	3	004260064
5	8,3	50	6	33.00	3	004260065
6	9,4	50	6	34.50	3	004260066
7	10,4	54	6	40.50	3	004260067
8	12,4	54	8	42.00	3	004260068
9	15,0	56	10	47.00	3	004260069
10	16,5	60	10	53.50	3	004260070
11	20,5	63	10	69.00	3	004260071
12	25,0	66	10	104.50	3	004260072
13	28,0	71	12	131.00	3	004260073
14	31,0	71	12	140.00	3	004260074



DIN 335-C

	CHF		
426T/SP6	266.00	1	004260080
GR 3-5-7-8-10-11			
Ø 6,3+20,5 mm			
426/SPV	30.50	1	004260035

426SB

Fraise à noyer à 3 dents en acier HSS



GR	Ø	D	L	CHF		
	mm	mm	mm			
426/SB1	1 2+5	6	45	29.50	1	004260101
426/SB2	2 5+10	8	48	36.50	1	004260102
426/SB3	3 10+15	10	65	65.00	1	004260103
426/SB4	4 15+20	12	85	126.00	1	004260104
426/SB5	5 20+25	15	102	211.50	1	004260105
426/SB6	6 25+30	15	115	358.00	1	004260106



	CHF		
426SB/SP4	292.00	1	004260130
426/SB1-426/SB2			
426/SB3-426/SB4			
Ø 2+20 mm			
426SB/SPV1	30.50	1	004260135

426MD-3/CP3

Fraise lime rotative en métal dur

• Coupe croisée douce avec brise-copeaux



L	Ø	CHF		
mm	mm			
38,1	3	16.10	1	004260332

426MD-3/CT3

Fraise lime rotative en métal dur

• Coupe croisée douce avec brise-copeaux



L	Ø	CHF		
mm	mm			
37,8	3	16.10	1	004260333

426MD-3/F3

Fraise lime rotative en métal dur

• Coupe croisée douce avec brise-copeaux



L	Ø	CHF		
mm	mm			
38,3	3	16.10	1	004260334

426MD-3/FA3

Fraise lime rotative en métal dur

• Coupe croisée douce avec brise-copeaux



L	Ø	CHF		
mm	mm			
38,2	3	16.10	1	004260339

426MD-3/OG3

Mini foret rotatif en métal dur

• Coupe croisée douce avec brise-copeaux



L	Ø	CHF		
mm	mm			
38,1	3	16.10	1	004260337

426MD-3/OV3

Fraise lime rotative en métal dur

• Coupe croisée douce avec brise-copeaux



L mm	Ø mm	CHF		
38,2	3	16.10	1	004260331

426MD-3/S3

Fraise lime rotative en métal dur

• Coupe croisée douce avec brise-copeaux



L mm	Ø mm	CHF		
38,0	3	16.10	1	004260338

426MD-3/T3

Fraise lime rotative en métal dur

• Coupe croisée douce avec brise-copeaux



L mm	Ø mm	CHF		
38,3	3	16.10	1	004260336

426MD-3/TA3

Fraise lime rotative en métal dur

• Coupe croisée douce avec brise-copeaux



L mm	Ø mm	CHF		
38,3	3	16.10	1	004260335



426MD-3/A9

426MD-3/OV3 - 426MD-3/CP3
426MD-3/CT3 - 426MD-3/F3
426MD-3/TA3 - 426MD-3/T3
426MD-3/OG3 - 426MD-3/S3
426MD-3/FA3

CHF		
145.00	1	004260349

426MD/CP

Fraise Lime rotative en métal dur

coupe croisée HM6



L mm	Ø mm	CHF		
50	6	44.50	1	004260532
63	8	49.50	1	004260512
63	9,5	56.00	1	004260542
69	12	78.50	1	004260522
69	16	112.00	1	004260552

426MD/CT

Fraise Lime rotative en métal dur

coupe croisée HM6



L mm	Ø mm	CHF		
50	6	44.50	1	004260533
63	8	49.50	1	004260513
63	9,5	56.00	1	004260543
69	12	78.50	1	004260523
69	16	109.00	1	004260553

426MD/F

Fraise Lime rotative en métal dur

coupe croisée HM6



L mm	Ø mm	CHF		
50	6	44.50	1	004260534
63	8	49.50	1	004260514
63	9,5	56.00	1	004260544
69	12	78.50	1	004260524
69	16	88.50	1	004260554

426MD/FA

Fraise Lime rotative en métal dur

coupe croisée HM6



L mm	Ø mm	CHF		
50	6	44.50	1	004260539
63	8	49.50	1	004260519
63	9,5	56.00	1	004260549
69	12	78.50	1	004260529
69	16	101.00	1	004260559

426MD/OG

Fraise Lime rotative en métal dur

coupe croisée HM6



L mm	Ø mm	CHF		
50	6	44.50	1	004260537
63	8	49.50	1	004260517
70	10	56.00	1	004260547
76	12	78.50	1	004260527
81	16	112.00	1	004260557

426MD/OV

Lime rotative en métal dur

coupe croisée HM6



L mm	Ø mm	CHF		
50	6	44.50	1	004260531
61	9,5	56.00	1	004260541
67	12	78.50	1	004260521
69	16	101.00	1	004260551

426MD/S

Fraise Lime rotative en métal dur

coupe croisée HM6



L mm	Ø mm	CHF		
50	6	44.50	1	004260538
51	8	49.50	1	004260518
53	9,5	56.00	1	004260548
56	12	78.50	1	004260528
59	16	88.50	1	004260558

426MD/T

Fraise Lime rotative en métal dur

coupe croisée HM6



L mm	Ø mm	CHF		
50	6	44.50	1	004260536
63	8	49.50	1	004260516
63	9,5	56.00	1	004260546
69	12	78.50	1	004260526
70	16	88.50	1	004260556

426MD/TA

Fraise Lime rotative en métal dur

coupe croisée HM6



L mm	Ø mm	CHF		
50	6	44.50	1	004260535
67	8	49.50	1	004260515
72	9,5	56.00	1	004260545
73	12	78.50	1	004260525
78	16	112.00	1	004260555



CHF		
579.00	1	004260510

426MD/SP10
426MD/CP-426MD/CT-426MD/F
426MD/T-426MD/S
Ø 8-12 mm

427

Chasse-cônes Morse



DIN 317

GR	L mm	A mm	CHF	📦	🚚
0	92	13	15.60	3	004270000
1-2	140	19	22.10	3	004270002
3	190	25	26.50	3	004270003
4	225	30	44.50	3	004270004
5-6	260	35	82.00	3	004270006

428FP

Tarauts machine pour trous débouchants, pas gros, en acier HSS



ISO 529

M	■ mm	L mm	L1 mm	CHF	📦	🚚
3x0,5	2,7	56	11	21.60	10	004280003
4x0,7	3,4	63	13	21.60	10	004280004
5x0,8	4,9	70	16	21.60	10	004280005
6x1	4,9	80	19	22.70	10	004280006
8x1,25	6,2	90	22	27.50	10	004280008
10x1,5	8,0	100	24	32.00	10	004280010
12x1,75	7,0	110	29	42.00	5	004280012
14x2	9,0	110	30	51.50	5	004280014
16x2	9,0	110	30	62.00	5	004280016
18x2,5	11,0	125	34	80.00	3	004280018
20x2,5	12,0	140	34	90.00	3	004280020
22x2,5	14,5	140	34	108.00	3	004280022
24x3	14,5	160	38	117.00	3	004280024

428FC

Tarauts machine pour trous borgnes, pas gros, en acier HSS



ISO 529

M	■ mm	L mm	L1 mm	CHF	📦	🚚
3x0,5	2,7	56	11	26.00	10	004280103
4x0,7	3,4	63	13	26.00	10	004280104
5x0,8	4,9	70	16	26.00	10	004280105
6x1	4,9	80	19	27.00	10	004280106
8x1,25	6,2	90	22	29.00	10	004280108
10x1,5	8,0	100	24	34.00	10	004280110
12x1,75	7,0	110	29	44.00	5	004280112
14x2	9,0	110	30	59.00	5	004280114
16x2	9,0	110	30	69.50	5	004280116
18x2,5	11,0	125	34	93.00	3	004280118
20x2,5	12,0	140	34	100.00	3	004280120
22x2,5	14,5	140	34	121.50	3	004280122
24x3	14,5	160	38	129.00	3	004280124

428/C14

Coffret de 14 tarauts machine, 428FP et 428FC



428/C14	CHF	📦	🚚
428FP M3÷12	470.00	1	004280201
428FC M3÷12	27.50	1	004280202

429FP

Taraut machine pour trous débouchants, pas gros, HSS-CO 5%



ISO 529

M	■ mm	L mm	L1 mm	CHF	📦	🚚
3x0,5	2,7	56	11	28.00	5	004290003
4x0,7	3,4	63	13	28.00	5	004290004
5x0,8	4,9	70	16	28.00	5	004290005
6x1	4,9	80	19	30.50	5	004290006
8x1,25	6,2	90	22	33.50	5	004290008
10x1,5	8,0	100	24	39.50	5	004290010
12x1,75	7,0	110	29	49.50	5	004290012
14x2	9,0	110	30	66.50	5	004290014

429FC

Tarauts machine pour trous borgnes, pas gros, HSS-CO 5%



ISO 529

M	■ mm	L mm	L1 mm	CHF	📦	🚚
3x0,5	2,7	56	11	34.00	5	004290103
4x0,7	3,4	63	13	34.00	5	004290104
5x0,8	4,9	70	16	34.00	5	004290105
6x1	4,9	80	19	36.00	5	004290106
8x1,25	6,2	90	22	40.50	5	004290108
10x1,5	8,0	100	24	48.50	5	004290110
12x1,75	7,0	110	29	59.00	5	004290112
14x2	9,0	110	30	77.50	5	004290114

429/C14

Coffret de 14 tarauts machine 429FP et 429FC



429/C14	CHF	📦	🚚
429FP M3÷12	577.00	1	004290201
429FC M3÷12	27.50	1	004280202

430

Jeu de 3 tarauts à main, pas gros, en acier au chrome

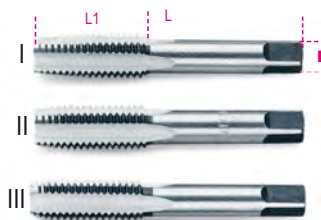

DIN 352 UNI 4535

M	■ mm	L mm	L1 mm	CHF	📦	🚚
2x0,4	2,5	36	11	18.70	5	004300002
3x0,5	2,5	40	12	13.30	5	004300003
4x0,7	3,0	45	14	13.30	5	004300004
5x0,8	4,0	48	16	13.80	5	004300005
6x1	5,0	50	18	13.90	5	004300006
7x1	4,5	50	18	17.90	5	004300007
8x1,25	5,0	56	22	18.00	3	004300008
9x1,25	5,5	63	22	24.30	3	004300009
10x1,5	6,0	70	25	23.10	3	004300010
11x1,5	7,0	70	25	29.50	3	004300011
12x1,75	7,0	75	30	29.50	3	004300012
14x2	8,0	80	32	37.00	3	004300014
16x2	10,0	80	32	44.00	3	004300016
18x2,5	11,0	95	40	59.00	1	004300018
20x2,5	12,0	95	40	70.50	1	004300020
22x2,5	14,5	100	40	86.00	1	004300022
24x3	14,5	110	50	101.50	1	004300024



430/SP21	CHF	📦	🚚
M 3-4-5-6-8-10-12	158.50	1	004300201
430/SPV	33.00	1	004300202

430ASW

Jeu de 3 tarauds à main, filetage Whitworth, en acier au chrome



DIN 352

BSW	mm	L	L1	CHF		
1/8x40	2,7	40	12	13.00	5	004300031
5/32x32	3,4	45	14	13.00	5	004300032
3/16x24	4,3	48	18	13.00	5	004300033
1/4x20	4,9	50	22	15.30	5	004300034
5/16x18	4,9	56	25	18.50	3	004300035
3/8x16	5,5	70	28	24.30	3	004300036
7/16x14	6,2	70	30	27.50	3	004300037
1/2x12	7,0	75	32	30.50	3	004300038
9/16x12	9,0	80	32	37.00	1	004300039
5/8x11	9,0	80	38	44.50	1	004300040
3/4x10	11,0	95	40	65.00	1	004300041
7/8x9	14,5	100	40	82.00	1	004300042
1"x8	16,0	110	50	105.50	1	004300043

430ASC

Jeu de 3 tarauds à main, filetage UNC en acier au chrome



ANSI B1.1

UNC	mm	L	L1	CHF		
1/4x20	4,9	70	30	19.40	5	004300051
5/16x18	4,9	70	30	25.00	5	004300052
3/8x16	5,5	75	35	28.00	3	004300053
7/16x14	6,2	80	40	36.50	3	004300054
1/2x13	7,0	85	45	46.00	3	004300055
9/16x12	9,0	90	45	56.50	3	004300056
5/8x11	9,0	100	47	65.00	3	004300057
3/4x10	11,0	110	50	88.00	3	004300058
7/8x9	14,5	120	60	101.00	1	004300059
1"x8	16,0	130	60	114.00	1	004300060

431

Jeu de 3 tarauds à main, pas gros en acier HSS



DIN 352 UNI 4535

M	mm	L	L1	CHF		
3x0,5	2,5	40	12	25.00	5	004310003
4x0,7	3,0	45	14	25.00	5	004310004
5x0,8	4,0	48	16	26.00	5	004310005
6x1	5,0	50	18	26.00	5	004310006

M	mm	L	L1	CHF		
7x1	5,0	50	18	34.00	5	004310007
8x1,25	5,0	56	22	31.00	3	004310008
10x1,5	6,0	70	25	38.50	3	004310010
12x1,75	7,0	75	30	58.00	3	004310012
14x2	9,0	80	32	82.00	1	004310014
16x2	9,0	80	32	92.50	1	004310016
18x2,5	11,0	95	40	138.00	1	004310018
20x2,5	12,0	95	40	148.00	1	004310020
22x2,5	12,0	100	40	212.00	1	004310022
24x3	14,5	110	50	238.50	1	004310024



431/SP21	CHF		
M 3-4-5-6-8-10-12	290.00	1	004310201
431/SPV	33.00	1	004310202

433

Jeu de 2 tarauds à main, pas fin, en acier au chrome



DIN 2181 UNI 4535

M	mm	L	L1	CHF		
6x0,75	4,5	48	16	11.50	5	004330201
7x0,75	4,5	56	18	14.40	5	004330202
8x0,75	5,0	50	16	14.40	5	004330203
8x1	5,0	56	16	14.40	5	004330204
9x0,75	6,0	63	22	18.70	5	004330205
9x1	6,0	63	22	18.70	5	004330206
10x0,75	6,5	63	18	18.70	5	004330207
10x1	6,5	63	18	18.70	5	004330208
10x1,25	6,5	63	18	18.70	5	004330209
11x0,75	7,0	70	25	25.50	3	004330210
11x1	7,0	70	25	25.50	3	004330211
11x1,25	7,0	70	25	25.50	3	004330212
12x0,75	7,0	70	20	24.60	3	004330213
12x1	7,0	70	20	24.60	3	004330214
12x1,25	7,0	70	20	24.60	3	004330215
12x1,5	7,0	70	20	24.60	3	004330216
14x1	8,0	80	32	32.00	1	004330217
14x1,25	8,0	80	32	32.00	1	004330218
14x1,5	8,0	80	32	32.00	1	004330219
16x1	10,0	80	32	38.00	1	004330220
16x1,5	10,0	80	32	38.00	1	004330221
18x1,5	11,0	95	40	44.50	1	004330222
18x2	11,0	80	25	58.00	1	004330223
20x1,5	14,5	80	22	66.50	1	004330224
22x1,5	14,5	80	22	79.50	1	004330225
24x1,5	14,5	80	22	92.50	1	004330226
24x2	14,5	80	22	91.50	1	004330227



433ASF

Jeu de 2 tarauds à main, filetage UNF pas fin, en acier au chrome



ANSI B1.1

UNF	mm	L	L1	CHF		
1/4x28	4,9	70	30	14.60	5	004330301
5/16x24	4,9	70	30	17.50	5	004330302
3/8x24	5,5	75	35	19.70	3	004330303
7/16x20	6,2	80	40	25.00	3	004330304
1/2x20	7,0	85	45	31.50	3	004330305
9/16x18	9,0	90	45	39.50	3	004330306
5/8x18	9,0	100	47	44.50	3	004330307
3/4x16	11,0	110	50	60.50	3	004330308
7/8x14	14,5	120	60	78.50	1	004330309
1"x12	16,0	130	60	107.00	1	004330310

433ASG

Jeu de 2 tarauds à main, filetage GAS, en acier au chrome



DIN 5157

GAS	mm	L	L1	CHF		
1/8x28	5,5	65	18	20.80	1	004330401
1/4x19	9,0	70	24	26.50	1	004330402
3/8x19	9,0	75	25	32.00	1	004330403
1/2x14	12,0	80	31	45.00	1	004330405
3/4x14	16,0	90	33	75.00	1	004330408
1"x11	20,0	100	39	121.50	1	004330410

434

Jeu de 2 tarauds à main, pas fin, en acier HSS

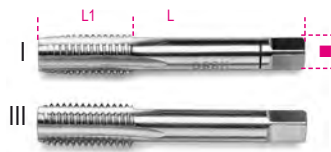

DIN 2181 UNI 4535

M	mm	L	L1	CHF		
6x0,75	4,5	48	16	33.00	5	004340001
8x0,75	5,0	56	16	38.50	5	004340003
8x1	5,0	56	16	38.50	5	004340004
10x0,75	6,5	63	18	48.50	5	004340007
10x1	6,5	63	18	48.50	5	004340008
10x1,25	6,5	63	18	48.50	5	004340009
12x1	7,0	70	20	52.00	3	004340014
12x1,25	7,0	70	20	52.00	3	004340015
12x1,5	7,0	70	20	52.00	3	004340016
13x1,5	9,0	70	20	109.00	1	004340017
14x1	9,0	70	20	65.00	1	004340018
14x1,25	9,0	70	20	65.00	1	004340019
14x1,5	9,0	70	20	56.00	1	004340020
15x1,5	9,0	70	20	109.00	1	004340021
16x1	9,0	70	20	70.00	1	004340022
16x1,5	9,0	70	20	60.00	1	004340023
18x1,5	11,0	80	22	78.00	1	004340024
18x2	11,0	90	25	94.00	1	004340025
20x1,25	12,0	80	22	134.00	1	004340026
20x1,5	12,0	80	22	83.00	1	004340027
20x2	12,0	90	25	102.50	1	004340028
22x1,5	14,5	80	22	119.00	1	004340029
24x1	14,5	80	22	158.50	1	004340030
24x1,5	14,5	80	22	134.00	1	004340031
24x2	14,5	80	22	140.00	1	004340032

435

Tourne-à-gauche extensible
corps en acier



DIN 1814

	□ mm	L mm	CHF		
435/0	2÷5 M1÷M8	170	22.50	3	004350007
435/1	2÷6 M1÷M10	200	27.00	2	004350009
435/1,5	2,5÷6 M1÷M12	200	28.50	2	004350011
435/2	3÷7 M4÷M12	260	40.50	2	004350013
435/3	4÷12 M5÷M20	345	67.50	1	004350020
435/4	5,5÷16 M9÷M27	430	104.50	1	004350027
435/5	7÷18 M13÷M32	770	237.50	1	004350032

435G

Tourne-à-gauche extensible
série légère



DIN 1814

	□ mm	L mm	CHF		
435G/0	2÷5 M1÷M8	130	16.00	5	004350108
435G/1	2÷6 M1÷M10	190	19.50	5	004350110
435G/1,5	2÷7 M2÷M12	175	20.30	5	004350112
435G/2	3,4÷7 M4÷M12	280	33.50	5	004350114
435G/3	4,9÷12 M5÷M20	380	54.00	2	004350121
435G/4	7÷16 M11÷M27	500	86.00	2	004350127
435G/5	7÷18 M13÷M32	700	135.50	1	004350132
435G/6	11÷24 M18÷M42	800	224.00	1	004350142

436

Porte-outils à cliquet réversible

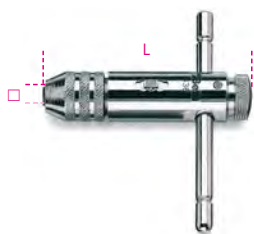

	□ mm	L mm	CHF		
436/1	2÷5 M3÷M8	85	37.00	5	004360002
436/2	4,6÷8 M5÷M12	110	47.00	5	004360004

436L

Porte-outils à cliquet réversible long

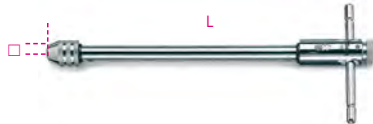

	□ mm	L mm	CHF		
436L/1	2÷5 M3÷M8	245	59.00	2	004360012
436L/2	4,6÷8 M5÷M12	295	69.00	2	004360014

436R

Etaux de rechange pour 436 et 436L

	CHF		
436R/1	6.95	1	004360022
436R/2	7.90	1	004360024

437P

Kit de réparation filetage interne et externe,
droite et gauche.

P 0,80±3,00 mm



L mm	CHF		
230	60.50	1	004370003

437C

Kit de réparation des filetages endommagés
de bougies, M14x1,25 mm

• hauteur hélicoïdes : 8,40 - 12,40 - 16,40 mm (5 pièces par mesure)



	CHF		
437C	157.50	1	004370100

437C/...

Hélicoïdes en acier inoxydable pour 437C



H mm	CHF		
8.4	40.50	1	004370108
12.4	40.50	1	004370112
16.4	40.50	1	004370116

Les prix indiqués sont pour 10 pièces

437C/RM14

Tarauds pour filetages de bougies M14x 1,25



	CHF		
437C/RM14	131.00	1	004370124

437K/8

Kit de réparation filetages arbres de roues

• Permet de rétablir et de raviver le filetage original.
Compris dans le kit :
• mesures métriques :
20x1,25 - 20x1,5 - 22x1,00 - 22x1,5 - 24x1,5 - 24x2,00
• mesures en pouces :
3/4x20 - 13/16x20



○ 32 mm

	CHF		
437K/8	103.50	1	004370020

≡ 200x110x30 mm

437K/9

Kit de réparation pour filetages
mâle et femelle, vis fixation roues

Permet de rétablir et de raviver le filetage original

Compris dans le kit :
• tarauds :
M12x1,25 - M12x1,5 - M12x1,75 - M14x1,5
• filières :
M12x1,25 - M12x1,5 - M14x1,5



○ 12 - 24 mm

	CHF		
437K/9	109.00	1	004370029

≡ 161x123x50 mm

437K/10

Kit de réparation
des filetages endommagés
des capteurs oxygène M18x1,5

Compris dans le kit :

- 1 aléuse pilote M18
- 1 taraud M18x1,5
- 1 taraud M20x1,5
- 5 filetages d'apport M18x1,5
- 1 outil de manœuvre pour filetages d'apport



○ 13 - 27 mm

437K/10	CHF 165.00	1	004370030
≡ 190x105x40 mm			

437K/12

Kit de réparation filetages arbres de roues

Permet de rétablir et de raviver le filetage original

Compris dans le kit:

- mesures métriques :
M16x1,0 - M16x1,5 - M20x1,0 - M20x1,5 - M22x1,5 - M24x1,5 -
M24x2,0 - M27x2,0
- mesures en pouces :
3/4x16 - 3/4x20 - 13/16x20 - 27/32x20



○ 32 - 35 mm

437K/12	CHF 131.00	1	004370032
≡ 220x118x52 mm			

437K/16

Kit de réparation des filetages
endommagés sur les supports des étriers de
freins M9x1,25



437K/16	CHF 146.50	1	004370016
≡ 210x150x50 mm			

437K/33

Kit de réparation pour filetages endommagés
de bougies de préchauffage

Filetages d'apport :

M8x1,0 - M10x1,0 - M10x1,25 - M12x1,25

Tarauds :

M8x1,0 - M10x1,0 - M10x1,25 - M12x1,0 - M12x1,25 - M14x1,25



437K/33	CHF 365.00	1	004370133
≡ 210x150x50 mm			

437U/09

Kit de réparation des filetages endommagés
M5-M6-M8-M10-M12



25 x M5, M6, M8, M10
10 x M12

437U/09	CHF 441.00	1	004370550
M5X0,8			
M6X1,0			
M8X1,25			
M10X1,5			
M12X1,75			
≡ 370x230x55 mm - 2 Kg			

437U/E-M...

Hélicoïdes en acier inoxydable



	H mm	CHF	1	
M5	7.5	23.60	1	004370555
M6	9	23.60	1	004370556
M8	12	32.00	1	004370558
M10	15	42.50	1	004370560
M12	18	27.00	1	004370562

Les prix indiqués se réfèrent à 25 pièces (10 pour la mesure M12)

437U/PM

Forets et tarauds mâles pour 437U/09



	CHF	1	
M5	44.00	1	004370565
M6	46.00	1	004370566
M8	62.00	1	004370568
M10	82.00	1	004370570
M12	101.50	1	004370572

438A

Jeu de forets pour percer, fileter et aléser, en
acier HSS

- M3 - M4 - M5 - M6 - M8 - M10
- Avec poignée porte-embouts magnétique

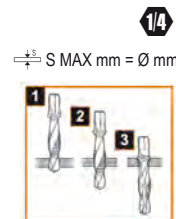

438A	CHF 149.00	1	004380010
------	---------------	---	-----------

438...

Forets pour percer, fileter et aléser

en acier HSS, embout 1/4"

1/4"



	S max mm	CHF	1	
M3	3	28.50	2	004380103
M4	4	28.50	2	004380104
M5	5	28.50	2	004380105
M6	6	28.50	2	004380106
M8	8	32.00	2	004380108
M10	10	32.00	2	004380110

440

Filière ronde, pas gros,
en acier au chrome

R ≤ 600 N/mm²
HRC | 60+61

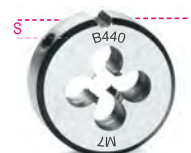

UNI 4535
DIN 223

M	Ø x S mm	CHF	1	
2x0,4	25,4 x 9	22.60	5	004400002
3x0,5	25,4 x 9	16.60	5	004400003
4x0,7	25,4 x 9	16.60	5	004400004
5x0,8	25,4 x 9	14.30	5	004400005
6x1	25,4 x 9	14.30	5	004400006
7x1	25,4 x 9	14.30	5	004400007
8x1,25	25,4 x 9	14.30	5	004400008
9x1,25	25,4 x 9	14.30	5	004400009
10x1,5	25,4 x 9	14.30	5	004400010
12x1,75	25,4 x 9	14.30	5	004400012

440A

Filière ronde, **pas gros**,
en acier au chrome

R ≤ 600 N/mm²
HRC 60±61



UNI 4535
DIN 223

M	Ø x S mm	CHF	🔧	📄
10x1,5	38,1 x 14	20.30	3	004400110
11x1,5	38,1 x 14	20.30	3	004400111
12x1,75	38,1 x 14	20.30	3	004400112
14x2	38,1 x 14	20.30	3	004400114
16x2	38,1 x 14	20.30	3	004400116
18x2,5	38,1 x 14	23.70	3	004400118
20x2,5	38,1 x 14	26.00	3	004400120

440B

Filière ronde, **pas gros**,
en acier au chrome

R ≤ 600 N/mm²
HRC 60±61



UNI 4535
DIN 223

M	Ø x S mm	CHF	🔧	📄
18x2,5	50,8 x 16	36.00	3	004400122
20x2,5	50,8 x 16	38.00	3	004400124
22x2,5	50,8 x 16	41.00	3	004400126
24x3	50,8 x 16	41.50	3	004400128

440ASW

Filière ronde, filetage **Whitworth**,
en acier au chrome

R ≤ 600 N/mm²



UNI EN 22568
DIN 223

BSW	Ø x S mm	CHF	🔧	📄
1/8x40	25,4 x 9	19.20	5	004400201
5/32x32	25,4 x 9	19.20	5	004400202
3/16x24	25,4 x 9	17.20	5	004400203
1/4x20	25,4 x 9	17.20	5	004400204
5/16x18	25,4 x 9	17.20	5	004400205
3/8x16	38,1 x 14	24.60	3	004400206
7/16x14	38,1 x 14	24.60	3	004400207
1/2x12	38,1 x 14	25.50	3	004400208
9/16x12	38,1 x 14	25.50	3	004400209
5/8x11	50,8 x 16	44.00	3	004400210
3/4x10	50,8 x 16	44.00	3	004400211
7/8x9	50,8 x 16	51.00	3	004400212
1"x8	50,8 x 16	51.00	3	004400213

440ASC

Filière ronde, filetage **UNC**, **pas gros**,
en acier au chrome

R ≤ 600 N/mm²



UNI EN 22568
DIN 223

UNC	Ø x S mm	CHF	🔧	📄
1/4x20	25,4 x 9	17.10	5	004400221
5/16x18	25,4 x 9	17.10	5	004400222
3/8x16	38,1 x 14	23.70	3	004400223
7/16x14	38,1 x 14	23.70	3	004400224
1/2x13	38,1 x 14	23.70	3	004400225
9/16x12	38,1 x 14	23.70	3	004400226
5/8x11	50,8 x 16	49.50	3	004400227
3/4x10	50,8 x 16	49.50	3	004400228
7/8x9	50,8 x 16	49.50	3	004400229
1"x8	50,8 x 16	49.50	3	004400230

440ASF

Filière ronde, filetage **UNF**, **pas fin**,
en acier au chrome



UNI EN 2258
DIN 223

UNF	Ø x S mm	CHF	🔧	📄
1/4x28	25,4 x 9	18.10	5	004400241
5/16x24	25,4 x 9	18.10	5	004400242
3/8x24	38,1 x 14	26.00	3	004400243
7/16x20	38,1 x 14	26.00	3	004400244
1/2x20	38,1 x 14	26.00	3	004400245
9/16x18	38,1 x 14	26.00	3	004400246
5/8x18	50,8 x 16	52.00	3	004400247
3/4x16	50,8 x 16	52.00	3	004400248
7/8x14	50,8 x 16	52.00	3	004400249
1"x12	50,8 x 16	52.00	3	004400250

440ASG

Filière ronde, filetage **GAS**,
en acier au chrome

R ≤ 600 N/mm²



UNI EN 24231
DIN 223

GAS	Ø x S mm	CHF	🔧	📄
1/8x28	38,1 x 14	20.30	3	004400255
1/4x19	38,1 x 14	20.30	3	004400256
3/8x19	38,1 x 14	20.30	3	004400257
1/2x14	50,8 x 16	41.50	3	004400259
3/4x14	50,8 x 16	41.50	3	004400260
1"x11	63,5 x 19	82.00	3	004400261

441

Filière ronde, **pas fin**,
en acier au chrome

R ≤ 600 N/mm²
HRC 60±61



UNI 4535
DIN 223

M	Ø x S mm	CHF	🔧	📄
6x0,75	25,4 x 9	17.20	5	004410004
7x0,75	25,4 x 9	17.20	5	004410005
8x0,75	25,4 x 9	17.20	5	004410006
8x1	25,4 x 9	17.20	5	004410007
9x0,75	25,4 x 9	17.20	5	004410008
9x1	25,4 x 9	17.20	5	004410009

441A

Filière ronde, **pas fin**,
en acier au chrome

R ≤ 600 N/mm²
HRC 60±61



UNI 4535
DIN 223

M	Ø x S mm	CHF	🔧	📄
10x0,75	38,1 x 14	26.00	3	004410100
10x1	38,1 x 14	26.00	3	004410101
10x1,25	38,1 x 14	26.00	3	004410102
11x0,75	38,1 x 14	26.00	3	004410103
11x1	38,1 x 14	26.00	3	004410104
11x1,25	38,1 x 14	26.00	3	004410105
12x0,75	38,1 x 14	26.00	3	004410106
12x1	38,1 x 14	26.00	3	004410107
12x1,25	38,1 x 14	26.00	3	004410108
12x1,5	38,1 x 14	26.00	3	004410109
14x1	38,1 x 14	26.00	3	004410110
14x1,25	38,1 x 14	26.00	3	004410111
14x1,5	38,1 x 14	26.00	3	004410112
16x1	38,1 x 14	26.00	3	004410113
16x1,5	38,1 x 14	26.00	3	004410114
18x1,5	38,1 x 14	26.00	3	004410115



441B

Filière ronde, pas fin, en acier au chrome

R ≤ 600 N/mm²
HRC || 60+61



UNI 4535
DIN 223

M	Ø x S mm	CHF		
18x1,5	50,8 x 16	47.50	3	004410117
18x2	50,8 x 16	47.50	3	004410118
20x1,5	50,8 x 16	48.50	3	004410119
22x1,5	50,8 x 16	51.00	3	004410120
24x1,5	50,8 x 16	51.50	3	004410121
24x2	50,8 x 16	51.50	3	004410122

442

Filière ronde, pas gros, en acier HSS

HRC || 62+63
AISI M2



UNI EN 22568
DIN 223

M	Ø x S mm	CHF		
3x0,5	20x5	20.00	3	004420003
4x0,7	20x5	20.00	3	004420004
5x0,8	20x7	20.30	3	004420005
6x1	20x7	20.30	3	004420006
7x1	25x9	22.70	3	004420007
8x1,25	25x9	22.70	3	004420008
10x1,5	30x11	26.00	3	004420010
12x1,75	38x14	43.50	3	004420012
14x2	38x14	56.00	1	004420014
16x2	45x18	70.50	1	004420016
18x2,5	45x18	75.00	1	004420018
20x2,5	45x18	75.00	1	004420020

443

Filière ronde, filetage UNF, pas fin, en acier HSS

HRC || 62+63
AISI M2



UNI EN 22568
DIN 223

M	Ø x S mm	CHF		
6x0,75	20x7	34.00	1	004430107
8x0,75	25x9	38.00	1	004430110
8x1	25x9	36.00	1	004430111
10x0,75	30x11	46.50	1	004430113
10x1	30x11	41.50	1	004430114
10x1,25	30x11	41.50	1	004430115
12x1	38x10	68.00	1	004430116
12x1,25	38x10	68.00	1	004430117
12x1,5	38x10	68.00	1	004430118
13x1,5	38x10	81.00	1	004430119
14x1	38x10	68.00	1	004430120

M	Ø x S mm	CHF		
14x1,25	38x10	68.00	1	004430121
14x1,5	38x10	68.00	1	004430122
15x1,5	38x10	91.00	1	004430123
16x1	45x14	100.50	1	004430124
16x1,5	45x14	100.50	1	004430125
18x1,5	45x14	100.50	1	004430127
20x1,25	45x14	103.50	1	004430129
20x1,5	45x14	103.50	1	004430130
20x2	45x14	103.50	1	004430131
22x1,5	55x16	125.00	1	004430132
24x1	55x16	129.50	1	004430133
24x1,5	55x16	129.50	1	004430135
24x2	55x16	137.00	1	004430136

444

Porte-filières, corps en acier



EN 22568
DIN 225

	Ø mm	L mm	CHF		
444	20x5	190	27.00	5	004440005
444/0	20x7	190	27.00	5	004440007
444/1	25,4x9,5	210	28.50	5	004440025
444/1A	25x9	215	29.00	5	004440027
444/1B	30x11	250	33.50	5	004440030
444/C	38x10	310	42.50	3	004440033
444/1C	38x14	310	42.50	3	004440035
444/2	38,1x12,7	300	44.00	3	004440038
444/1D	45x14	445	60.00	1	004440045
444/2D	45x18	445	60.00	1	004440046
444/3	50,8x15,9	520	87.00	1	004440050
444/4	55x16	495	87.00	1	004440055
444/5A	63,5x19	520	149.50	1	004440057

444G

Porte-filières, corps en alliages légers



UNI EN 22568
DIN 225

	Ø mm	L mm	CHF		
444G/A	16x5	160	12.80	5	004440103
444G	20x5	185	14.80	5	004440105
444G/0	20x7	185	14.80	5	004440107
444G/1	25,4x9,5	215	18.00	5	004440125
444G/1A	25x9	215	18.00	5	004440127
444G/1B	30x11	265	23.10	5	004440130
444G/C	38x10	315	33.50	3	004440133
444G/1C	38x14	315	33.50	3	004440135
444G/2	38,1x12,6	310	33.50	3	004440138
444G/1D	45x14	450	44.00	1	004440145
444G/2D	45x18	450	45.00	1	004440146
444G/3	50,8x16	485	47.00	1	004440150
444G/4	55x16	560	57.00	1	004440155
444G/5A	63,5x19	630	100.50	1	004440163
444G/6	65x18	630	106.50	1	004440165

446/C30

Composition de tarauds 430 et de filières 440 en acier au chrome, en coffret bois



446/C30	CHF		
	414.00	1	004460055

325x220x35 mm - 3,2 Kg

430	440		
M	M		
mm	mm		
3x0,5	3x0,5	435/1,5	444/1
4x0,7	4x0,7		
5x0,8	5x0,8		
6x1	6x1		
8x1,25	8x1,25		
10x1,5	10x1,5		
12x1,75	12x1,75		

446/C48

Composition de tarauds 430 et de filières 440 et 440A en acier au chrome, en coffret bois



446/C48	CHF		
	785.00	1	004460057

580x300x50 mm - 5 Kg

430	440	440A		
M	M	M		
mm	mm	mm		
3x0,5	3x0,5	10x1,5	435/1	444/1
4x0,7	4x0,7	12x1,75	435/3	444/2
5x0,8	5x0,8	14x2		
6x1	6x1	16x2		
8x1,25	8x1,25	18x2,5		
10x1,5		20x2,5		
12x1,75				
14x2				
16x2				
18x2,5				
20x2,5				



446/C110

Composition de tarauds 430 et 433
et de filières 440, 440A, 441, 441A
en acier au chrome "spéciale automobile"
en coffret bois



446/C110 CHF 1,135.00 1 004460060

500x337x60 mm - 8,1 Kg

430	433	440/440A	441/441A
M	M	M	M
mm	mm	mm	mm
2x0,4	6x0,75	2x0,4	6x0,75
3x0,5	7x0,75	3x0,5	7x0,75
4x0,7	8x0,75	4x0,7	8x0,75
5x0,8	8x1	5x0,8	8x1
6x1	9x0,75	6x1	9x0,75
7x1	9x1	7x1	9x1
8x1,25	10x0,75	8x1,25	10x0,75
9x1,25	10x1	9x1,25	10x1
10x1,5	10x1,25	10x1,5	10x1,25
11x1,5	11x0,75	11x1,5	11x0,75
12x1,75	11x1	12x1,75	11x1
14x2	11x1,25	14x2	11x1,25
16x2	12x0,75	16x2	12x0,75
	12x1		12x1
	12x1,25		12x1,25
	12x1,5		12x1,5
	14x1		14x1
	14x1,25		14x1,25
	14x1,5		14x1,5
	16x1		16x1
	16x1,5		16x1,5
	18x1,5		18x1,5

435/0	444/1	436/1
435/3	444/2	

446ASF/C29

Composition de tarauds 433ASF
et de filières 440ASF
en acier au chrome, filetage UNF,
en coffret bois



446ASF/C29 CHF 899.00 1 004460070

660x410x50 mm - 6 Kg

433ASF	440ASF		
1/4	1/4	435/1,5	444/1
5/16	5/16	435/3	444/2
3/8	3/8		444/3
7/16	7/16		
1/2	1/2		
9/16	9/16		
5/8	5/8		
3/4	3/4		

446ASW/C36

Composition de tarauds 430ASW
et de filières 440ASW
en acier au chrome, filetage Whitworth
en coffret bois



446ASW/C36 CHF 665.00 1 004460075

525x310x50 mm - 3,4 Kg

430ASW	440ASW		
1/8	1/8	435/1,5	444/1
5/32	5/32	435/2	444/2
3/16	3/16		
1/4	1/4		
5/16	5/16		
3/8	3/8		
7/16	7/16		
1/2	1/2		

446ASC/C37

Composition de tarauds 430ASC
et de filières 440ASC
en acier au chrome, filetage UNC
en coffret bois



446ASC/C37 CHF 962.00 1 004460080

660x410x50 mm - 6,7 Kg

430ASC	440ASC		
1/4	1/4	435/1,5	444/1
5/16	5/16	435/3	444/2
3/8	3/8		444/3
7/16	7/16		
1/2	1/2		
9/16	9/16		
5/8	5/8		
3/4	3/4		

446ASG/C23

Composition de tarauds 433ASG
et de filières 440ASG
en acier au chrome, filetage GAS,
en coffret bois



446ASG/C23 CHF 1,400.00 1 004460085

700x430x70 mm - 9,8 Kg

433ASG	440ASG		
1/8	1/8	435/3	444/2
1/4	1/4	435/5	444/3
3/8	3/8		444/5A
1/2	1/2		
3/4	3/4		
1"	1"		

Beta

447/C37

Composition de tarauds 431
et de filières 442 en acier HSS
en coffret métallique



447/C37 CHF 844.00 1 004470055

380x185x35 mm - 3,9 Kg

431 M mm	442 M mm		
3x0,5	3x0,5	435/0	444
4x0,7	4x0,7	435/2	444/0
5x0,8	5x0,8		444/1A
6x1	6x1		444/1B
8x1,25	8x1,25		444/1C
10x1,5	10x1,5		
12x1,75	12x1,75		

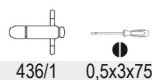

436/1 0,5x3x75

447/C53

Composition de tarauds 431
et de filières 442 en acier HSS
en coffret métallique



447/C53 CHF 1.740.00 1 004470060

500x235x50 mm - 9 Kg

431 M mm	442 M mm			
3x0,5	3x0,5	435/1,5	444	436/1
4x0,7	4x0,7	435/3	444/0	436/2
5x0,8	5x0,8		444/1A	
6x1	6x1		444/1B	
8x1,25	8x1,25		444/1C	
10x1,5	10x1,5		444/2D	
12x1,75	12x1,75			
14x2	14x2			
16x2	16x2			
18x2,5	18x2,5			
20x2,5	20x2,5			

447/C70

Composition de tarauds 431, 434
et de filières 442, 443 en acier HSS
en coffret bois



447/C70 CHF 2.190.00 1 004470065

510x340x70 mm - 7,5 Kg

431 M mm	434 M mm	442 M mm	443 M mm
3x0,5	8x1	3x0,5	8x1
4x0,7	10x1,25	4x0,7	10x1,25
5x0,8	12x1,25	5x0,8	12x1,25
6x1	12x1,5	6x1	12x1,5
7x1	14x1,25	7x1	14x1,25
8x1,25	14x1,5	8x1,25	14x1,5
10x1,5	16x1,5	10x1,5	16x1,5
12x1,75		12x1,75	
14x2		14x2	
16x2		16x2	



435/0 444 436/1
435/3 444/0
444/1A
444/1B
444/C
444/1C
444/1D
444/2D

450

Scie trépan en acier HSS - BIMETAL



HSS-Co 8%

Ø mm	Ø	A mm	CHF		
16	(5/8)	57	21.80	1	004500016
17	(11/16)	57	21.80	1	004500017
19	(3/4)	51	21.80	1	004500019
20	-	51	21.80	1	004500020
21	(13/16)	51	21.80	1	004500021
22	(7/8)	51	21.80	1	004500022
24	(15/16)	51	21.80	1	004500024
25	(1")	51	23.90	1	004500025
27	(1 1/16)	51	24.80	1	004500027
29	(1 1/8)	51	24.80	1	004500029
30	(1 3/16)	51	24.80	1	004500030
32	(1 1/4)	51	24.80	1	004500032
33	(1 5/16)	51	25.50	1	004500033
35	(1 3/8)	51	28.50	1	004500035

Ø mm	Ø	A mm	CHF		
37	(1 1/4)	51	28.50	1	004500037
38	(1 1/2)	44	29.50	1	004500038
40	(1 9/16)	44	30.00	1	004500040
41	(1 5/8)	44	31.00	1	004500041
43	(1 11/16)	44	31.00	1	004500043
44	(1 3/4)	44	32.00	1	004500044
46	(1 13/16)	44	32.00	1	004500046
48	(1 7/8)	44	33.00	1	004500048
51	(2")	44	34.00	1	004500051
52	(2 1/16)	44	38.00	1	004500052
54	(2 1/8)	44	38.00	1	004500054
57	(2 1/4)	44	38.00	1	004500057
59	(2 5/16)	44	39.50	1	004500059
60	(2 3/8)	44	39.50	1	004500060
64	(2 1/2)	44	41.50	1	004500064
65	(2 9/16)	44	41.50	1	004500065
67	(2 5/8)	44	41.50	1	004500067
68	-	44	41.50	1	004500068
70	(2 3/4)	44	42.50	1	004500070
73	(2 7/8)	44	42.50	1	004500073
76	(3")	44	44.00	1	004500076
79	(3 1/8)	44	46.50	1	004500079
83	(3 1/4)	44	48.50	1	004500083
86	(3 3/8)	44	48.50	1	004500086
89	(3 1/2)	44	51.00	1	004500089
92	(3 5/8)	44	54.00	1	004500092
95	(3 3/4)	44	56.50	1	004500095
98	(3 7/8)	44	57.50	1	004500098
102	(4")	44	60.00	1	004500102
105	(4 1/8)	44	65.00	1	004500105
108	(4 1/4)	44	81.00	1	004500108
111	(4 3/8)	44	92.50	1	004500111
114	(4 1/2)	44	109.00	1	004500114
121	(4 3/4)	44	121.50	1	004500121
127	(5")	44	133.50	1	004500127
140	(5 1/2)	44	162.00	1	004500140
152	(6")	44	188.00	1	004500152

450AL

Mandrin et foret pilote pour 450

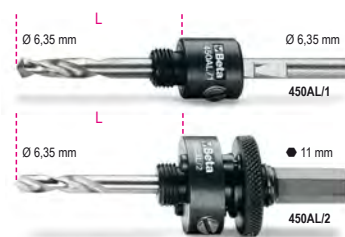

	Ø mm	L mm	CHF		
450AL/1	16÷30	54	26.50	1	004500210
450AL/2	32÷152	70	62.00	1	004500215

450AD

Adaptateur pour 450AL/1



	Ø mm	CHF		
450AD	32÷51	10.50	1	004500230



450PA/1

Foret pilote HSS pour 450AL/1

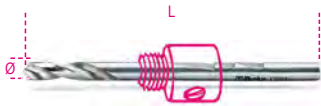

ØxL
mm
6,35x105

CHF 16.50

1 004500252

450PA/2

Foret pilote HSS pour 450AL/2

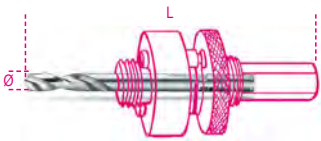

ØxL
mm
6,35x80

CHF 16.50

1 004500253

450PR

Rallonge pour 450



L
mm
305

CHF 44.50

1 004500255

450/C9

Composition «spéciale électricité»



HSS-Co 8%

450/C9

CHF 316.00

1 004500305

450 Ø 22 - 29 - 35 - 44 - 51 - 64 mm

450AL /1 - /2

450AD

220x160x60 mm - 1,6 Kg

450/C13

Composition

«spéciale métallerie-serrurerie»



HSS-Co 8%

450/C13

CHF 396.00

1 004500310

450 Ø 19 - 22 - 29 - 35 - 38

44 - 51 - 57 - 64 mm

450AL /1 - /2

450PA/1

450AD

215x180x65 mm - 1,8 Kg

450/C15

Composition de scies trépan
et accessoires pour électriciens



450/C15

CHF 518.00

1 004500313

450 Ø 16 - 20 - 25 - 32 - 40

51 - 60 - 65 - 70 mm

450AL /1 - /2

450PA /1 - /2

450PR

450AD

420x185x60 mm - 3,2 Kg

450/C21

Composition «spéciale industrie»



HSS-Co 8%

450/C21

CHF 905.00

1 004500315

450 Ø 19 - 22 - 29 - 35 - 38

44 - 51 - 57 - 64 - 76

83 - 92 - 95 - 105 - 114 mm

450AL /1 - /2

450PA /1 - /2

450PR

450AD

420x280x60 mm - 7 Kg

451

Fraise trépan en acier HSS
entièrement rectifiée

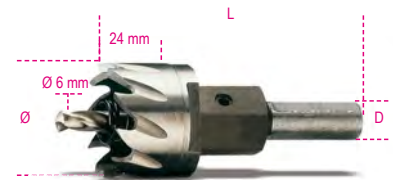

Ø mm	L mm	D mm	CHF		
12	85	8	33.00	1	004510012
13	85	8	33.00	1	004510013
14	85	8	33.50	1	004510014
15	85	10	33.50	1	004510015
16	85	10	33.50	1	004510016
17	85	10	33.50	1	004510017
18	85	10	33.50	1	004510018
19	85	10	34.00	1	004510019
20	85	10	36.00	1	004510020
21	85	10	38.50	1	004510021
22	85	10	40.50	1	004510022
23	85	10	42.00	1	004510023
24	85	10	43.50	1	004510024
25	85	10	44.50	1	004510025
26	90	10	47.00	1	004510026
27	90	10	48.50	1	004510027
28	90	10	49.50	1	004510028
29	90	10	51.50	1	004510029
30	90	10	52.00	1	004510030
31	90	10	55.00	1	004510031
32	90	10	56.50	1	004510032
33	90	10	58.00	1	004510033
34	90	10	60.00	1	004510034
35	90	10	62.00	1	004510035
36	85	10	64.00	1	004510036
37	85	10	65.00	1	004510037
38	85	10	66.50	1	004510038
39	85	10	68.00	1	004510039
40	85	10	69.50	1	004510040
41	85	10	71.50	1	004510041
42	85	10	75.00	1	004510042
43	85	10	77.50	1	004510043
44	85	10	78.50	1	004510044
45	85	10	80.50	1	004510045
46	85	10	80.50	1	004510046
47	85	10	83.00	1	004510047
48	85	10	87.00	1	004510048
49	85	10	89.00	1	004510049
50	85	10	89.00	1	004510050

451GA

Mandrin pour 451



M	∅ mm	L mm	D mm	CHF		
10x1,25	12÷14	57	8	18.60	1	004510101
12x1,25	15÷34	57	10	18.60	1	004510102
14x1,5	35÷50	57	10	22.70	1	004510105

451PA

Foret pilote pour 451 en acier HSS



∅ mm	L mm	CHF		
6	53	10.50	1	004510103

451PR

Rallonge pour 451



M	∅ mm	L mm	∅1 mm	CHF		
12x1,25	15÷34	400	13	81.00	1	004510104
14x1,5	35÷50	400	13	81.00	1	004510108



452

Scie trépan à dents carbure

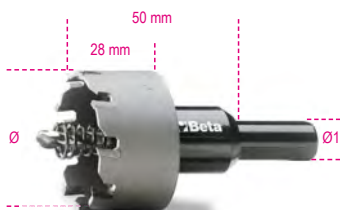

∅ mm	∅1 mm	CHF		
15	10	134.00	1	004520015
16	10	134.00	1	004520016
17	10	134.00	1	004520017
18	10	134.00	1	004520018
19	10	134.00	1	004520019
20	10	134.00	1	004520020
21	10	134.00	1	004520021
22	10	134.00	1	004520022
23	10	134.00	1	004520023
24	10	134.00	1	004520024
25	10	134.00	1	004520025
26	10	150.50	1	004520026
27	10	150.50	1	004520027
28	10	150.50	1	004520028
29	10	150.50	1	004520029
30	10	150.50	1	004520030
31	10	181.50	1	004520031
32	10	181.50	1	004520032
33	10	181.50	1	004520033
34	10	181.50	1	004520034
35	10	181.50	1	004520035
36	10	211.00	1	004520036
37	10	211.00	1	004520037
38	10	211.00	1	004520038
39	13	211.00	1	004520039
40	13	211.00	1	004520040
41	13	237.50	1	004520041
42	13	237.50	1	004520042
43	13	237.50	1	004520043
44	13	237.50	1	004520044
45	13	237.50	1	004520045
46	13	267.00	1	004520046
47	13	267.00	1	004520047
48	13	267.00	1	004520048
49	13	267.00	1	004520049
50	13	267.00	1	004520050
55	13	303.00	1	004520055
60	13	403.00	1	004520060
65	13	403.00	1	004520065
70	13	470.00	1	004520070
75	13	512.00	1	004520075
80	13	556.00	1	004520080
85	13	626.00	1	004520085
90	13	665.00	1	004520090

452GA

Mandrin pour 452



	∅ mm	CHF		
452GA/1	15÷21	16.60	1	004520125
452GA/2	22÷38	19.40	1	004520126
452GA/3	39÷100	23.10	1	004520127

460

Scie trépan pour le secteur de la construction en bâtiment

- Pour béton armé, ciment, pierres naturelles et artificielles
- Profondeur maximale de perçage 60 mm

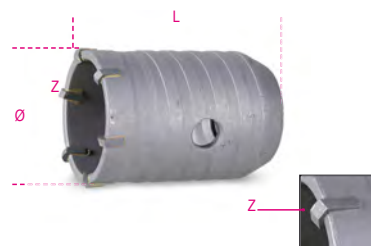

∅ mm	L mm	Z	CHF		
50	75	6	68.00	1	004600050
60	75	6	81.00	1	004600060
65	75	6	85.00	1	004600065
80	75	6	126.00	1	004600080
90	75	6	133.50	1	004600090
100	75	8	163.00	1	004600100
112	75	8	186.50	1	004600112
125	80	10	232.50	1	004600125
150	80	12	314.00	1	004600150

460PP

foret pilote pour scies trépan pour le secteur de la construction en bâtiment 460



∅ mm	L mm	CHF		
8	120	7.75	1	004600201

460G

Mandrin pour scies trépan 460



L mm	CHF		
220	42.00	1	004600222
370	59.00	1	004600237
460	93.00	1	004600246



MULTIPLICATEURS DE COUPLE

Les multiplicateurs de couple sont des outils essentiels pour serrer les écrous et les vis, car ils permettent de générer un couple plus élevé que celui que l'opérateur appliquerait normalement, dans des espaces restreints ou difficilement accessibles. Ils ne nécessitent pas de rallonges encombrantes, assurant ainsi une sécurité totale. **La gamme de multiplicateurs de couple Beta** offre une variété de solutions, de capacités (jusqu'à 9 500 Nm), et des rapports de multiplication de couple (jusqu'à 135:1). De nombreux modèles, en particulier les plus puissants, sont équipés d'un système anti-enroulement bidirectionnel, pour éviter les retours de tension dangereux sur l'opérateur. Tous les multiplicateurs de couple Beta sont accompagnés d'un **certificat** prouvant que l'outil a été testé à sa valeur maximale et dans des conditions optimales de fonctionnement.



Mode d'emploi

Le multiplicateur de couple doit être toujours **utilisé avec une clé dynamométrique** afin d'assurer le contrôle du couple de sortie, mais aussi avec des douilles à chocs.

Les rapports de chaque multiplicateur de couple déterminent le **facteur de multiplication** entre le couple d'entrée et le couple de sortie. Exemple : un multiplicateur de couple avec le rapport 5:1, si l'application du couple d'entrée est de 100 Nm, et défini par la clé dynamométrique, le couple de sortie sera de 500 Nm.

Il faut s'assurer obligatoirement que toutes les pièces impliquées dans le serrage sont correctement alignées.

Il faut également éviter d'utiliser des **rallonges** car elles se tordraient, produisant ainsi un effet ressort qui modifierait les valeurs de couple appliquées.

Il faut toujours vérifier que le **bras de réaction** du multiplicateur de couple a été fixé ou repose sur une structure solide, capable de résister à la force de réaction. En règle générale, on utilise des murs suffisamment rigides ou des points d'appuis à proximité. Le bras de réaction tourne toujours dans le sens **opposé** au sens de serrage.

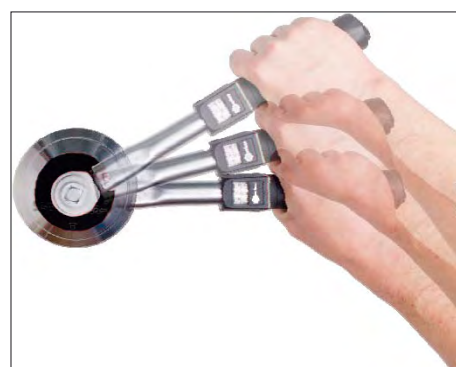

Fonctionne en douceur et sans interruption.

La tension de serrage doit être relâchée en tournant le multiplicateur de couple dans l'autre sens, avant de le désengager. Si le multiplicateur de couple est équipé d'un système anti-enroulement, la tension de serrage doit être relâchée par le levier d'inversion.

Les instructions ci-dessus s'appliquent également aux opérations de **desserrage**.

560/C3

Multiplicateur de couple pour serrages à droite et gauche en coffret plastique rapport 3,8:1 avec système à cliquet anti-retour

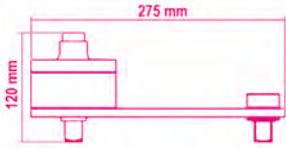

Nm	kgfm	lbf.ft	□	■	kg
1500	150	1110	1/2"	3/4"	3,9

CHF					
560/C3	1,128.00	1	005600030		
≡ 400x260x110 mm					

560/C3PLUS

Multiplicateur de couple pour serrages à droite et gauche en coffret plastique rapport 3,8:1 avec système à cliquet anti-retour

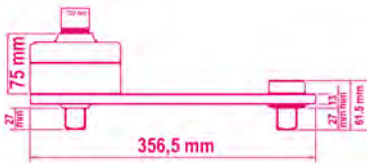

Nm	kgfm	lbf.ft	□	■	kg
2700	270	1991	3/4"	1"	7,5

CHF					
560/C3PLUS	1,315.00	1	005600038		
≡ 470x240x160 mm					

560/C2

Multiplicateur de couple et accessoires pour serrages à droite et à gauche rapport 5:1 en coffre plastique pour un usage intensif

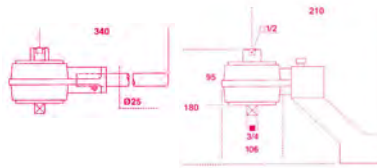
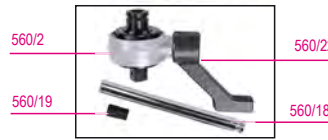

Nm	Kgfm	lbf.ft	□	■	kg
1300	130	960	1/2"	3/4"	3,8

CHF					
560/C2	2,295.00	1	005600020		
560/2	1,705.00	1	005600002		
560/18	54.00	1	005600018		
560/19	114.00	1	005600019		
560/22	396.00	1	005600022		
≡ 310x275x120 mm					

560/C4+

Multiplicateur de couple et accessoires pour serrages à droite et à gauche rapport 5:1 avec bras de réaction pour un usage intensif

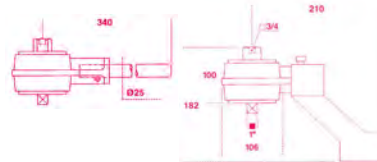

Nm	Kgfm	lbf.ft	□	■	kg
2700	270	2000	3/4"	1"	5

CHF					
560/C4PLUS	2,250.00	1	005600042		
560/4	1,780.00	1	005600004		
560/18	54.00	1	005600018		
560/22	396.00	1	005600022		
≡ 310x275x120 mm					

560/C6

Multiplicateur de couple, pour serrage droite/gauche en coffret plastique Rapport 6,5:1



Nm	kgfm	lbf.ft	□	■	kg
1500	150	1106	1/2"	3/4"	6

CHF					
560/C6	1,174.00	1	005600160		
≡ 400x260x110 mm					

560/C12

Multiplicateur de couple, pour serrage droite/gauche en coffret plastique Rapport 12:1



Nm	kgfm	lbf.ft	□	■	kg
2500	250	1844	1/2"	1"	7

CHF					
560/C12	1,685.00	1	005600210		
≡ 400x260x110 mm					

561/1

Multiplicateur de couple, pour serrages à droite et gauche rapport 5:1 avec deux jambes de force

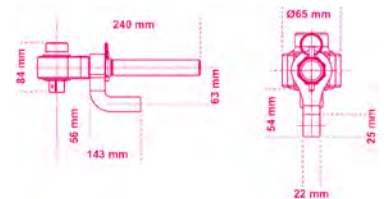

Nm	kgfm	lbf.ft	□	■	kg
1000	100	740	1/2"	3/4"	2,7

CHF					
561/1	1,645.00	1	005610010		
≡ 270x210x70 mm					

562-1/VA - 562-2/VA

multiplicateurs de couple pour le serrage à droite et à gauche rapport 5,2:1 en coffret 562VV-A



Nm	Kgfm	lbf.ft	□	■	D	A	L min	L max	⚖
1700	170	1250	3/4	1"	mm	mm	mm	mm	kg
					108	95	85	220	8,8

562-1/VA CHF 3,650.00 1 005620601

Nm	Kgfm	lbf.ft	□	■	D	A	L min	L max	⚖
3400	340	2500	3/4	1"	mm	mm	mm	mm	kg
					119	115	85	265	10,5

562-2/VA CHF 4,410.00 1 005620602

564-3R/V - 564-4R/V

Multiplicateurs de couple pour les serrages à droite et à gauche rapport 25:1 avec système anti-remorçant, en coffret



Nm	Kgfm	lbf.ft	□	■	D	A	L	⚖
4000	400	3000	1/2	1"	mm	mm	mm	kg
					92	185	205	7,6

564-3R/V CHF 7,110.00 1 005640613

☞ 390x310x145 mm

Nm	Kgfm	lbf.ft	□	■	D	A	L	⚖
7000	700	5000	1/2	1 1/2"	mm	mm	mm	kg
					120	200	210	13,2

564-4R/V CHF 8,390.00 1 005640614

☞ 500x435x170 mm

565-1R/VA - 565-2R/VA - 565-3R/VA

multiplicateurs de couple pour le serrage à droite et à gauche rapport 27:1 avec système anti-remorçant, en coffret 562VV-A



Nm	Kgfm	lbf.ft	□	■	D	A	L min	L max	⚖
1700	170	1250	1/2	1"	mm	mm	mm	mm	kg
					108	125	80	215	11,2

565-1R/VA CHF 5,900.00 1 005650611

Nm	Kgfm	lbf.ft	□	■	D	A	L min	L max	⚖
3400	340	2500	1/2	1"	mm	mm	mm	mm	kg
					119	145	85	265	13,6

565-2R/VA CHF 7,700.00 1 005650612

Nm	Kgfm	lbf.ft	□	■	D	A	L min	L max	⚖
3400	340	2500	1/2	1 1/2"	mm	mm	mm	mm	kg
					119	145	85	265	14,2

565-3R/VA CHF 8,130.00 1 005650613

565-4R/VA

multiplicateur de couple pour le serrage à droite et à gauche rapport 27:1 avec système anti-remorçant, en coffret 565VV-B

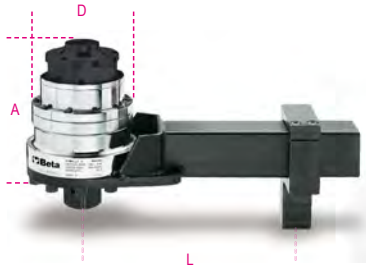

Nm	Kgfm	lbf.ft	□	■	D	A	L min	L max	⚖
6000	600	4500	1/2	1 1/2"	mm	mm	mm	mm	kg
					144	180	125	335	22,4

565-4R/VA CHF 9,190.00 1 005650614

565-5R/VA

multiplicateur de couple pour le serrage à droite et à gauche rapport 27:1 avec système anti-remorçant, en coffret 565VV-B

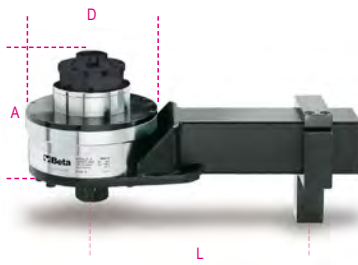

Nm	Kgfm	lbf.ft	□	■	D	A	L min	L max	⚖
9500	950	7000	3/4	1 1/2"	mm	mm	mm	mm	kg
					184	180	155	355	30,4

565-5R/VA CHF 15,640.00 1 005650615

567-4R/VA

multiplicateur de couple pour le serrage à droite et à gauche rapport 135:1 avec système anti-remorçant, en coffret 565VV-B

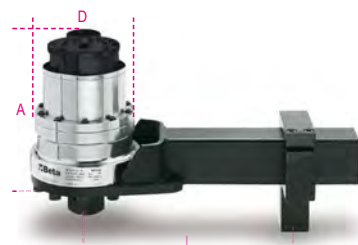

Nm	Kgfm	lbf.ft	□	■	D	A	L min	L max	⚖
6000	600	4500	1/2	1 1/2"	mm	mm	mm	mm	kg
					144	210	125	335	24,4

567-4R/VA CHF 10,210.00 1 005670614

567-5R/VA

multiplicateur de couple pour le serrage à droite et à gauche rapport 135:1 avec système anti-remorçant, en coffret 565VV-B

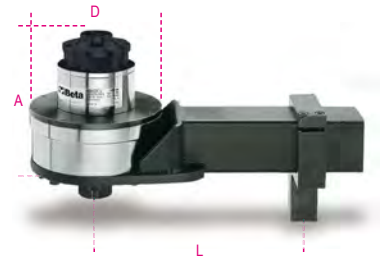

Nm	Kgfm	lbf.ft	□	■	D	A	L min	L max	⚖
9500	950	7000	1/2	1 1/2"	mm	mm	mm	mm	kg
					184	210	155	350	32,4

567-5R/VA CHF 17,520.00 1 005670615

562VV-A

Valise pour multiplicateurs, en polypropylène à haute résistance, avec éponge

Mesures intérieures 380x270x180 mm



562VV-A CHF 312.00 1 005620501

562/1-562/2-564/3R
564/4R-565/1R-565/2R
565/3R

☞ 410x340x205 mm - ⚖ 3,5 kg

565VV-B

Valise pour multiplicateurs, en polypropylène à haute résistance, avec éponge

Mesures intérieures 480x370x205 mm



565VV-B CHF 422.00 1 005650502

565/4R-565/5R
567/4R-567/5R

☞ 520x435x230 mm - ⚖ 5,4 kg



Les clés dynamométriques doivent toujours être tenues au milieu de la poignée, afin de ne pas modifier le rapport de levier. Elles doivent être utilisées en douceur et sans interruption, en évitant les à-coups.



L'échelle de réglage doit être remise à zéro après utilisation, afin de ne pas affecter la précision du serrage.



Beta propose une large gamme de clés, avec **quatre types de fonctionnement différents**.

MODÈLES À LECTURE DIRECTE

Le couple de serrage appliqué est transmis directement à l'index de lecture par compression d'un ressort hélicoïdal. Le couple appliqué peut être lu en temps réel grâce à un pointeur. Un deuxième pointeur peut être positionné sur la valeur de couple cible. Lorsque la valeur de couple cible est atteinte, le deuxième pointeur sera accroché par le pointeur principal et enregistrera la valeur de crête. Les clés dynamométriques à lecture directe assurent une précision et une durabilité remarquables dans le temps.

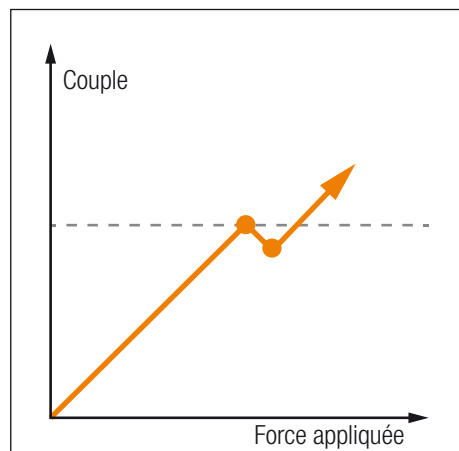

MODÈLES À CLIC

Les clés dynamométriques à clic sont les modèles les plus utilisés, car elles sont faciles d'utilisation. Elles permettent une présélection rapide du couple par charge de ressort. La valeur du couple augmente à mesure que la force appliquée augmente. Lorsque la valeur de couple requise est atteinte, un desserrage soudain se produit et la clé n'applique plus aucune force de serrage pendant environ 3-5°. Si l'opérateur n'interrompt pas le mouvement, le couple continuera d'augmenter, dépassant ainsi les valeurs requises.

MODÈLES A DECLENCHEMENT

Les clés dynamométriques à déclenchement fonctionnent comme les modèles à clic, mais lorsque la valeur de couple requise est atteinte, un relâchement soudain du bras de levier se produit (environ 20°). Par conséquent, il est plus facile pour l'opérateur d'arrêter d'appliquer une force. Ils sont normalement utilisés pour des valeurs de couple élevées avec des bras de levier extrêmement longs.

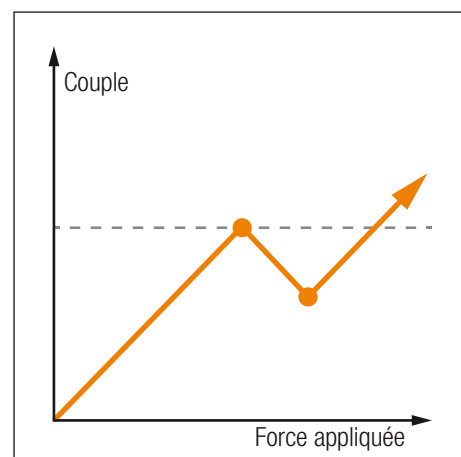
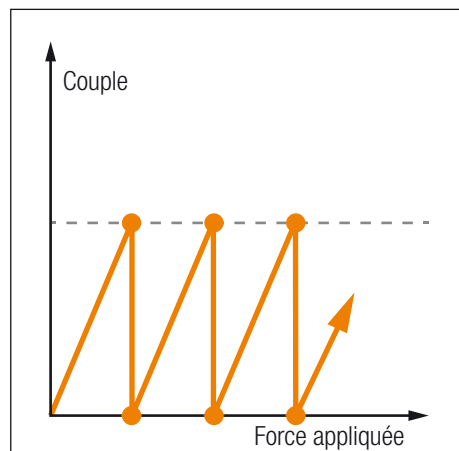

MODÈLES GLISSANTS

Lorsque la valeur de couple pré-réglée est atteinte, le mécanisme de glissement arrête l'application du couple, provoquant ainsi le ralenti de l'outil. Cela empêchera un serrage avec des valeurs de couple élevées par rapport à celles requises. Continuer à appliquer la force entraînera la répétition du même cycle. Elles sont idéales pour les opérations de série avec de faibles valeurs de couple (industries électroniques et micromécaniques), permettant d'éviter de casser des pièces délicates ou de petite taille.

Beta

581

Tournevis dynamométrique à débrayage mono-couple
Utilisable pour serrage droite
Précision de serrage : $\pm 6\%$
(S'utilise avec les articles 588 - 682)



UNI EN ISO 6789

Nm	gfm	lbf.in	g
1,2÷6	120÷600	1/4"	275

581 CHF 368.00 1 005810001

583

Tournevis dynamométrique à débrayage
Utilisable pour serrage droite
Précision de serrage : $\pm 6\%$



UNI EN ISO 6789

Nm	gfm	lbf.in	g
0,3÷1,5	30÷150	1/4"	240

583/1,5 CHF 414.00 1 005830015

Nm	gfm	lbf.in	g
0,6÷3	60÷300	1/4"	240

583/3 CHF 414.00 1 005830030

Nm	gfm	lbf.in	g
1,2÷6	120÷600	1/4"	350

583/6 CHF 414.00 1 005830060

583/C31

1 tournevis dynamométrique, 8 douilles
6 pans, 20 embouts pour visseuses et 2
accessoires

1/4"



583/C31 CHF 577.00 1 005830931

	583/6	1.2 - 6 Nm
	900	4-5-5,5-6-7-8-9-10 mm
	860LP	0,6x4,5 - 1x5,5 - 1,2x6,5 mm
	860PH	PH1 - PH2 (x2) - PH3
	860PE	2-2,5-3-4-5 mm
	860TX	T9-T10-T15-T20-T25-T27-T30-T40
	882P/80	80 mm
	892/0	1/4" 1/4"

270x120x45 mm - 1,2 kg

590 - 592

Clé dynamométrique à lecture directe
Utilisable pour serrage droite ou gauche
Précision de serrage : $\pm 4\%$

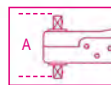

UNI EN ISO 6789

Nm	Kgfm	lbf.in	mm	A mm	L mm	kg
0,3÷4	0,03÷0,4	3÷35	1/4"	60	253	0,52

590 CHF 977.00 1 005900001

Nm	Kgfm	lbf.in	mm	A mm	L mm	kg
0,5÷13,5	0,05÷1,35	4÷120	1/4"	60	253	0,52

590/1 CHF 977.00 1 005900003

Nm	Kgfm	lbf.in	mm	A mm	L mm	kg
1÷27	0,1÷2,7	10÷240	3/8"	70	253	0,52

592/3 CHF 971.00 1 005920005

Nm	Kgfm	lbf.in	mm	A mm	L mm	kg
3÷40	0,3÷4	20÷360	3/8"	70	253	0,52

592/4 CHF 971.00 1 005920007

594

Clé dynamométrique à lecture directe
Utilisable pour serrage droite ou gauche
Précision de serrage : $\pm 4\%$

1/2"

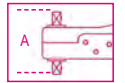

UNI EN ISO 6789

Nm	Kgfm	lbf.ft	mm	A mm	L mm	kg
6÷80	0,6÷8	5÷60	1/2"	85	455	1,35

594/8 CHF 1,470.00 1 005940011

Nm	Kgfm	lbf.ft	mm	A mm	L mm	kg
20÷215	2÷21,5	15÷160	1/2"	85	530	1,40

594/21 CHF 1,470.00 1 005940015

Service d'étalonnage
dynamométrique
à la fin du catalogue

596 - 598

Clé dynamométrique à lecture directe
Utilisable pour serrage droite ou gauche
Précision de serrage : $\pm 4\%$

pourvue d'indicateurs lumineux et sonores
qui se déclenchent lorsque le couple préfixé
est atteint



UNI EN ISO 6789

Nm	Kgfm	lbf.ft	mm	A mm	L mm	kg
80÷400	8÷40	60÷300	3/4"	111	710	3,2

596/40SL CHF 2,430.00 1 005960010

Nm	Kgfm	lbf.ft	mm	A mm	L mm	kg
160÷800	16÷80	120÷600	3/4"	115	1025	4,85

596/80SL CHF 3,060.00 1 005960020

Nm	Kgfm	lbf.ft	mm	A mm	L mm	kg
200÷2000	20÷200	150÷1500	1"	135	1930	16,70

598/200SL CHF 6,370.00 1 005980022

Beta
Quality Tools

Beta

599DGT

Clé dynamométrique électronique à cliquet réversible, pour serrages à droite et à gauche
précision de serrage +/- 2 % à droite, +/- 3 % à gauche

- Double indication d'approche et d'arrêt : crête et suivi
- L'obtention du couple programmé est indiqué par des témoins lumineux et par un signal sonore intermittent
- Alimentation : 2 piles - 1,5V fournies)



UNI EN ISO 6789

Nm	Kgfm	lbf.ft	■	D	A	L	■
12÷60	1,2÷6	8÷44	3/8	30	33	413	0,9

599DGT/6	CHF 517.00			1	005990003
-----------------	-------------------	--	--	---	-----------

Nm	Kgfm	lbf.ft	■	D	A	L	■
20÷100	2÷10	15÷80	1/2	30	37	413	0,9

599DGT/10X	CHF 532.00			1	005990010
-------------------	-------------------	--	--	---	-----------

Nm	Kgfm	lbf.ft	■	D	A	L	■
40÷200	4÷20	30÷150	1/2	40	43	520	2

599DGT/20	CHF 553.00			1	005990020
------------------	-------------------	--	--	---	-----------

Nm	Kgfm	lbf.ft	■	D	A	L	■
68÷340	6,8÷34	58÷280	1/2	40	43	640	2,35

599DGT/30	CHF 596.00			1	005990030
------------------	-------------------	--	--	---	-----------

599DGT-AN

Clé dynamométrique électronique à lecture de couple et d'angle avec cliquet réversible, pour serrages à droite (précision +/- 2%) et à gauche (précision +/- 3%)

- Typologies de serrage : couple, renvoi d'angle, couple + renvoi d'angle
- Stratégie de serrage : couple + renvoi d'angle
- Double indication d'approche et d'arrêt : crête et suivi
- L'obtention du couple/angle programmé est indiquée par des témoins lumineux et par un signal sonore intermittent
- Mémorisation des données de serrage (jusqu'à 250 valeurs)
- 9 valeurs de couple/renvoi d'angle réglables à l'avance
- Possibilité de régler les limites de tolérance en fonction des exigences ; lorsque ces limites sont dépassées, la clé avertit l'utilisateur
- Blocage de sécurité des touches
- Possibilité d'associer la clé à 16 utilisateurs par le biais de l'ID utilisateur
- Traçabilité des données de serrage. Le logiciel permet de mémoriser la date et l'heure, le numéro de série de l'outil, la valeur de serrage programmé, la valeur atteinte, et de les associer à l'ID utilisateur
- Poignée bi-matières antidérapante
- Comprend : 2 batteries AA - 1,5V, câble USB et logiciel



UNI EN 26789
ISO 6789

Nm	Kgfm	lbf.ft	■	D	A	L	■
20÷100	2÷10	15÷80	1/2	30	33	413	0,9

599DGT-AN/10	CHF 971.00			1	005990610
---------------------	-------------------	--	--	---	-----------

Nm	Kgfm	lbf.ft	■	D	A	L	■
40÷200	4÷20	30÷150	1/2	40	43	520	1,3

599DGT-AN/20	CHF 1,024.00			1	005990620
---------------------	---------------------	--	--	---	-----------

Service d'étalonnage dynamométrie à la fin du catalogue



600

Clé de serrage angulaire

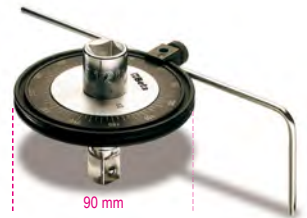

	□	■	CHF		
600/1	1/2	1/2	207.00	1	006000001
600/2	3/4	3/4	234.50	1	006000002

601C

Rapporteur numérique pour serrages angulaires
L'obtention de l'angle programmé est signalé par des témoins lumineux et un signal acoustique intermittent



601C	CHF 278.00			1	006010100
-------------	-------------------	--	--	---	-----------

85x80x87 mm - 70 g

601CA

Rapporteur numérique pour serrages couple et angulaires
L'obtention du couple ou de l'angle préfixés est indiquée par des signaux lumineux et par un son intermittent



	□	■	Nm	CHF		
601CA	1/2"	1/2"	10÷200	492.00	1	006010120

120x90x120 mm - 240 g

603

Clé dynamométrique à débrayage
Précision de serrage : ±6%



UNI EN ISO 6789

Nm	Kgfm	lbf.in	■	A mm	L mm	g
1÷5	0,1÷0,5	10÷45	1/4	35	195	235

603/5	CHF 838.00	1	006030005
--------------	-------------------	---	-----------

Nm	Kgfm	lbf.in	■	A mm	L mm	g
2÷10	0,2÷1,0	18÷90	1/4	35	195	235

603/10	CHF 858.00	1	006030010
---------------	-------------------	---	-----------

604B

Clé dynamométrique à cassure
Utilisable pour serrage droite ou gauche
Précision de serrage : ± 6%



UNI EN ISO 6789

Nm	kgfm	lbf.in	∅ mm	L mm	g
1÷5	0,1÷0,5	10÷45	8	220	290

604B/5	CHF 544.00	1	006040015
---------------	-------------------	---	-----------

Nm	Kgfm	lbf.in	∅ mm	L mm	g
2÷10	0,2÷1,0	18÷90	8	220	300

604B/10	CHF 544.00	1	006040020
----------------	-------------------	---	-----------

605E

Clé dynamométrique à déclenchement avec cliquet réversible
Utilisable pour serrage droit ou gauche
Précision de serrage : ± 6%



UNI EN ISO 6789

Nm	Kgfm	lbf.in	■	A mm	L mm	g
1÷5	0,1÷0,5	10÷45	1/4	20	190	180

605E/5	CHF 280.00	1	006050105
---------------	-------------------	---	-----------

Nm	Kgfm	lbf.in	■	A mm	L mm	g
2÷10	0,2÷1,0	18÷90	1/4	20	190	180

605E/10	CHF 292.00	1	006050110
----------------	-------------------	---	-----------

610/5

Clé dynamométrique à déclenchement avec cliquet réversible
Utilisable pour serrage droit avec 5 valeurs pré réglées
Précision de serrage : ± 4%

Couples sélectionnables
90 - 100 - 110 - 120 - 130 Nm



UNI EN ISO 6789

Nm	■	D mm	A mm	L mm	g
90÷130	1/2	42	39	490	1330

610/5	CHF 233.00	1	006100025
--------------	-------------------	---	-----------

610L/5

Clé dynamométrique à déclenchement avec levier en L
Utilisable pour serrage droit avec 5 valeurs pré réglées
Précision de serrage : ± 4%

Couples sélectionnables
90 - 100 - 110 - 120 - 130 Nm



UNI EN ISO 6789

Nm	■	L mm	L1 mm	g
90÷130	1/2	470	80	1350

610L/5	CHF 207.00	1	006100125
---------------	-------------------	---	-----------

610L/5L

Clé dynamométrique à déclenchement avec levier en L
Utilisable pour serrage à droite avec 5 valeurs pré réglées
précision de serrage : ± 4%

Couples sélectionnables :
120 - 140 - 160 - 180 - 200 Nm



UNI EN ISO 6789

Nm	■	L mm	L1 mm	g
120÷200	1/2	470	80	1400

610L/5L	CHF 213.00	1	006100150
----------------	-------------------	---	-----------

611

Cliquet réversible pour clés dynamométriques 604B/5 et 604B/10 avec entraînement 8 mm



■	L mm	CHF	1	006110001
1/4	42,5	196.00	1	006110001

Service d'étalonnage dynamométrique à la fin du catalogue

612 ÷ 614

Cliquet réversible



Les articles 612 et 612X ne doivent pas être utilisés avec des couples de serrage supérieurs à 100 Nm

	■	L mm	LA mm	CHF	1	006120000
612	3/8	66	32	88.00	2	006120000
612X	1/2	66	32	93.00	2	006120010
614	1/2	71	32	101.50	2	006140000
614X	3/4	71	32	111.00	2	006140004

614/50

Cliquet réversible à glissière



	■	L mm	LA mm	CHF	1	006140002
614/50	1/2	71	32	93.00	2	006140002

Voir le tableau après la ref. 928/C8 pour les pièces détachées du mécanisme de la tête de la clé dynamométrique

615

Cliquet réversible pour clés dynamométriques avec entraînement rectangulaire



mm	mm	L mm	LA mm	CHF		
9x12	3/8	53	28,8	74.50	1	006150010
9x12	1/2	53	28,8	74.50	1	006150020
14x18	1/2	70	39,8	74.50	1	006150120

616 - 617 - 619

Carrés mâles



mm	mm	L mm	LA mm	CHF		
616	1/4	61	32	69.50	1	006160000
617	3/8	61	32	69.50	1	006170000
619	1/2	63	32	69.50	1	006190000

621

Accessoire porte-embouts pour clés dynamométriques avec entraînement rectangulaire



P	mm	mm	L mm	LA mm	CHF		
P 1/4	9x12	1/4	43	28,8	88.50	1	006210000
* P 5/16	14x18	5/16	52,5	32,5	135.50	1	006210110

*Attention ! Recalculer la valeur de couple à programmer conformément aux indications du tableau en fin de catalogue des prix.

622

Cliquets réversibles pour clé dynamométrique série 674 avec entraînement rond de Ø 22 mm



mm	mm	L mm	LA mm	CHF		
622 3/4	3/4	110	56	247.50	1	006220019
622 1	1	110	56	301.00	1	006220024

641

Clé à fourche pour clés dynamométriques 604B/5 et 604B/10 entraînement 8 mm



mm	L mm	CHF		
4	37	105.50	1	006410003
5	37	105.50	1	006410004
5,5	37	105.50	1	006410005
6	37	105.50	1	006410006
7	37	105.50	1	006410007
8	42	105.50	1	006410008
9	42	105.50	1	006410009
10	42	105.50	1	006410010

642

Clé à fourche



mm	L mm	LA mm	A mm	CHF		
8	54	32	22	75.00	1	006420008
10	57	32	26	75.00	1	006420010
12	58	32	30	75.00	1	006420012
13	58	32	30	75.00	1	006420013
14	59	32	32	75.00	1	006420014
15	59	32	35	75.00	1	006420015
16	59	32	38	75.00	1	006420016
17	60	32	39	75.00	1	006420017
18	61	32	42	75.00	1	006420018
19	61	32	43	75.00	1	006420019
20	61	32	50	116.50	1	006420020
21	62	32	53	116.50	1	006420021
22	62	32	53	127.50	1	006420022
23	65	32	53	127.50	1	006420023
24	63	32	53	127.50	1	006420024
26	64	32	59	156.00	1	006420026
27	65	32	59	156.00	1	006420027
28	66	32	64	156.00	1	006420028
30	66	32	66	156.00	1	006420030
32	67	32	66	156.00	1	006420032
* 36	76	42	80	214.00	1	006420036
* 40	77	52	95	214.00	1	006420040
* 41	78	52	95	214.00	1	006420041
* 46	90	52	95	258.00	1	006420046

*Attention ! Recalculer la valeur de couple à programmer conformément aux indications du tableau en fin de catalogue des prix.

643

Clé à fourche pour clés dynamométriques avec entraînement rectangulaire



mm	mm	L mm	LA mm	CHF		
7	9X12	37	28,8	65.50	1	006430007
8	9x12	37	28,8	65.50	1	006430008
10	9x12	39	28,8	65.50	1	006430010
12	9x12	39	28,8	65.50	1	006430012
13	9x12	39	28,8	65.50	1	006430013
14	9x12	43	28,8	66.50	1	006430014
15	9x12	43	28,8	66.50	1	006430015

*Attention ! Recalculer la valeur de couple à programmer conformément aux indications du tableau en fin de catalogue des prix.

mm	mm	L mm	LA mm	CHF		
16	9x12	43	28,8	66.50	1	006430016
17	9x12	43	28,8	66.50	1	006430017
* 18	9x12	47	36,3	66.50	1	006430018
* 19	9x12	51	36,3	66.50	1	006430019
* 21	9X12	52	36,3	103.00	1	006430021
* 22	9x12	52	36,3	103.00	1	006430022

*Attention ! Recalculer la valeur de couple à programmer conformément aux indications du tableau en fin de catalogue des prix.

mm	mm	L mm	LA mm	CHF		
13	14x18	60	39,8	69.00	1	006430113
14	14x18	58	39,8	69.00	1	006430114
15	14x18	60	39,8	69.00	1	006430115
16	14x18	60	39,8	69.50	1	006430116
17	14x18	60	39,8	69.50	1	006430117
18	14x18	61	39,8	69.50	1	006430118
19	14x18	61	39,8	69.50	1	006430119
21	14x18	61	39,8	108.50	1	006430121
22	14x18	62	39,8	108.50	1	006430122
24	14x18	64	39,8	108.50	1	006430124
* 27	14x18	68	44,8	122.50	1	006430127
* 30	14x18	77	49,8	123.50	1	006430130
* 32	14x18	77	49,8	123.50	1	006430132
* 34	14x18	80	54,8	196.00	1	006430134
* 36	14x18	83	54,8	196.00	1	006430136
* 38	14x18	83	54,8	196.00	1	006430138
* 41	14x18	91	64,8	196.00	1	006430141

*Attention ! Recalculer la valeur de couple à programmer conformément aux indications du tableau en fin de catalogue des prix.

644

Clés à fourches pour clé dynamométrique série 674 avec entraînement rond de 22 mm



mm	L mm	LA mm	A mm	CHF		
22	91	56	52	127.50	1	006440022
24	91	56	52	127.50	1	006440024
27	94	56	64	156.00	1	006440027
30	94	56	64	156.00	1	006440030
32	97	56	75,5	156.00	1	006440032
34	97	56	75,5	156.00	1	006440034
36	97	56	75,5	214.00	1	006440036
41	103,5	56	94	214.00	1	006440041
46	115,5	56	94	258.00	1	006440046

650A

Clé à molette pour clés dynamométriques avec entraînement rectangulaire



A min-max mm	mm	L mm	LA mm	CHF		
* 5-27	9X12	93	74,3	120.00	1	006500027
* 5-30	9X12	106	85,3	120.00	1	006500030
* 5-30	14X18	115	89	122.50	1	006500130
* 10-41	14X18	127	100	126.50	1	006500141

*Attention ! Recalculer la valeur de couple à programmer conformément aux indications du tableau en fin de catalogue des prix.

650H

Clé à ergot
pour clés dynamométriques
avec entraînement rectangulaire



mm	mm	L mm	LA mm	CHF		
* 28-36	14x18	122	92	64.00	1	006500928
* 40-45	14x18	129	92	64.00	1	006500940
* 50-55	14x18	129	92	64.00	1	006500950
* 58-62	14x18	135	92	67.50	1	006500958
* 68-75	14x18	139	92	73.50	1	006500968
* 80-90	14x18	145	92	73.50	1	006500980

652

Clé polygonale



mm	L mm	LA mm	CHF		
8	58	32	81.00	1	006520008
10	58	32	81.00	1	006520010
12	58	32	81.00	1	006520012
13	58	32	81.00	1	006520013
14	58	32	81.00	1	006520014
15	62	32	81.00	1	006520015
16	63	32	81.00	1	006520016
17	64	32	81.00	1	006520017
18	65	32	81.00	1	006520018
19	65	32	81.00	1	006520019
21	67	32	122.00	1	006520021
22	68	32	129.00	1	006520022
24	69	32	154.50	1	006520024
26	71	32	173.50	1	006520026
27	71	32	173.50	1	006520027
30	73	32	173.50	1	006520030
32	74	32	173.50	1	006520032

653

Clé polygonale
pour clés dynamométriques
avec entraînement rectangulaire

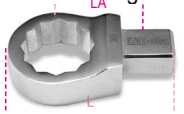

mm	mm	L mm	LA mm	CHF		
7	9x12	40	28,8	70.00	1	006530007
8	9x12	40	28,8	70.00	1	006530008
10	9x12	43	28,8	70.00	1	006530010
12	9x12	44	28,8	70.00	1	006530012
13	9x12	44	28,8	70.00	1	006530013
14	9x12	45	28,8	70.00	1	006530014
15	9x12	46	28,8	70.00	1	006530015
16	9x12	47	28,8	70.50	1	006530016
17	9x12	47	28,8	70.50	1	006530017
18	9x12	48	28,8	70.50	1	006530018
19	9x12	49	28,8	70.50	1	006530019
21	9x12	51	28,8	73.50	1	006530021
22	9x12	51	28,8	73.50	1	006530022

mm	mm	L mm	LA mm	CHF		
13	14x18	61	39,8	77.50	1	006530113
14	14x18	61	39,8	77.50	1	006530114
15	14x18	62	39,8	77.50	1	006530115
16	14x18	63	39,8	78.00	1	006530116

*Attention ! Recalculer la valeur de couple à programmer conformément aux indications du tableau en fin de catalogue des prix.

mm	mm	L mm	LA mm	CHF		
17	14x18	64	39,8	78.00	1	006530117
18	14x18	64	39,8	78.00	1	006530118
19	14x18	66	39,8	78.00	1	006530119
21	14x18	66	39,8	113.00	1	006530121
22	14x18	67	39,8	113.00	1	006530122
24	14x18	69	39,8	140.50	1	006530124
* 27	14x18	76	44,8	140.50	1	006530127
* 30	14x18	77	44,8	140.50	1	006530130
* 32	14x18	79	44,8	140.50	1	006530132
* 34	14x18	80	44,8	199.50	1	006530134
* 36	14x18	80	44,8	199.50	1	006530136
* 38	14x18	90	49,8	204.00	1	006530138
* 41	14x18	90	49,8	204.00	1	006530141

*Attention ! Recalculer la valeur de couple à programmer conformément aux indications du tableau en fin de catalogue des prix.

654

Clés polygonales pour clé dynamométrique
série 674 avec entraînement rond, Ø 22 mm



mm	L mm	LA mm	A mm	CHF		
22	98,5	56	38	129.00	1	006540022
24	98,5	56	38	154.50	1	006540024
27	102,8	56	46,5	173.50	1	006540027
30	102,8	56	46,5	173.50	1	006540030
32	106,5	56	55	173.50	1	006540032
34	106,5	56	55	173.50	1	006540034
36	106,5	56	55	225.50	1	006540036
41	115,5	56	72	225.50	1	006540041
46	115,5	56	72	245.00	1	006540046

659/15

Raccord avec attache rectangulaire
femelle 14x18 mm et mâle 9x12 mm



mm	mm	mm	LA mm	CHF		
* 56	14x18	9x12	39	102.50	1	006590815



Toujours appliquer la force de serrage régulièrement et progressivement afin d'éviter la rupture et de se protéger contre un possible accident.

659/16

Raccord avec attache rectangulaire
femelle 9x12 mm et mâle 14x18 mm



mm	mm	mm	LA mm	CHF		
* 52	9x12	14x18	31	87.00	1	006590816

Beta

665 CLÉ DYNAMOMÉTRIQUE MÉCANIQUE AVEC AFFICHAGE NUMÉRIQUE

La clé dynamométrique 665 possède la robustesse et la fiabilité du mécanisme éprouvé de Beta et du cliquet permettant des lectures rapides avec un système numérique précis.

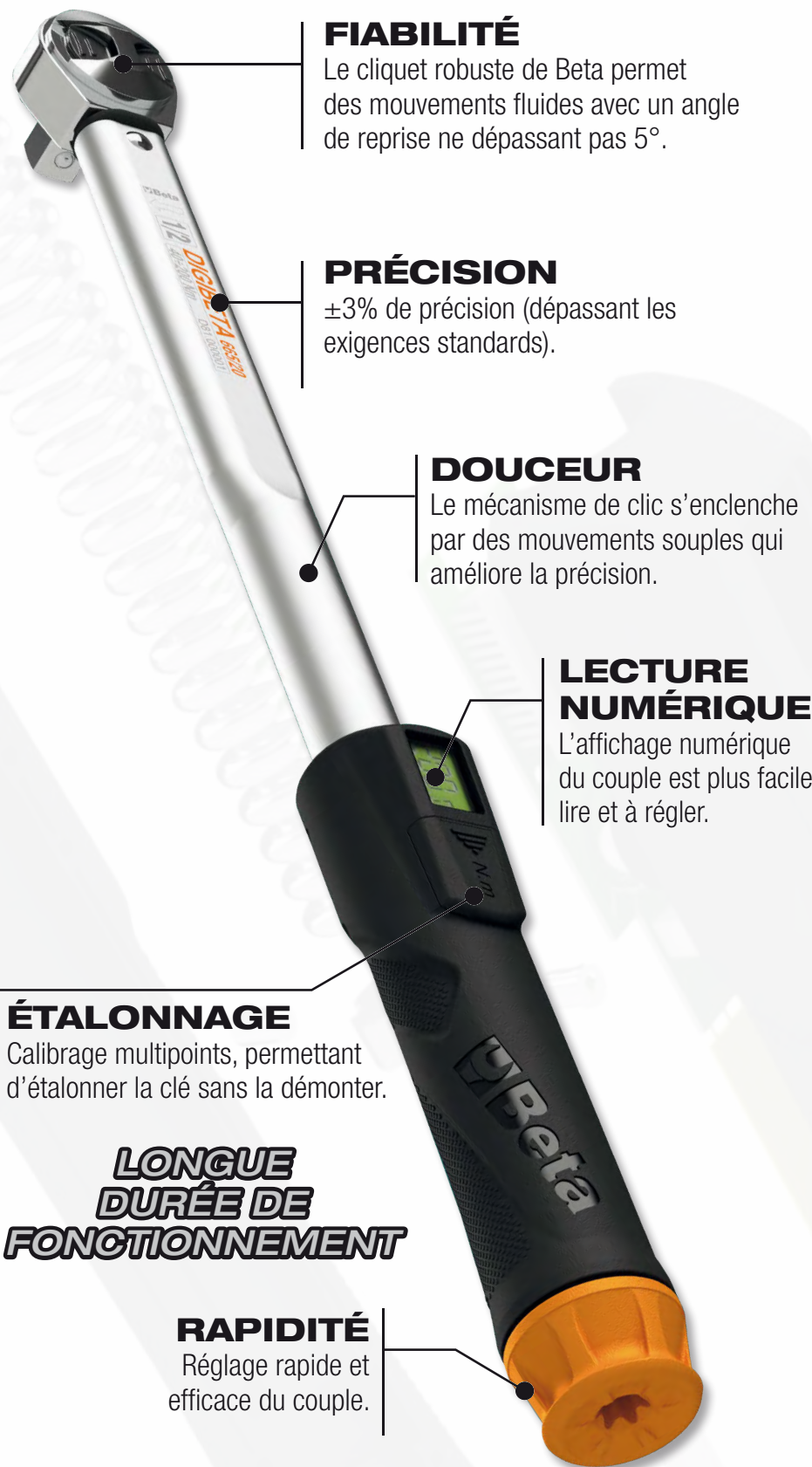

FIABILITÉ

Le cliquet robuste de Beta permet des mouvements fluides avec un angle de reprise ne dépassant pas 5°.

PRÉCISION

±3% de précision (dépassant les exigences standards).

DOUCEUR

Le mécanisme de clic s'enclenche par des mouvements souples qui améliore la précision.

LECTURE NUMÉRIQUE

L'affichage numérique du couple est plus facile lire et à régler.

ÉTALONNAGE

Calibrage multipoints, permettant d'étalonner la clé sans la démonter.

LONGUE DURÉE DE FONCTIONNEMENT

RAPIDITÉ

Réglage rapide et efficace du couple.

RÉGLAGE NUMÉRIQUE RAPIDE ET PRÉCIS DU COUPLE

665

Clé dynamométrique mécanique lecture digitale avec cliquet réversible, pour serrages à droite, précision de serrage ± 3 %

- Arrêt automatique après 10 secondes sous le seuil du couple minimum
- L'écran d'affichage reste éclairé avec la valeur de couple programmé
- Lecture du couple avec chiffre décimal
- Alimentation avec 1 pile de 3 V (comprise)



UNI EN ISO 6789

Nm	■	D mm	A mm	L mm	g
10÷60	3/8	30	33	335	655

665/6 CHF 310.00 1 006650006

Nm	■	D mm	A mm	L mm	g
20÷100	3/8	30	33	375	725

665/10 CHF 312.00 1 006650010

Nm	■	D mm	A mm	L mm	g
20÷100	1/2	30	37	375	725

665/10X CHF 319.00 1 006650011

Nm	■	D mm	A mm	L mm	g
40÷200	1/2	40	43	470	995

665/20 CHF 340.00 1 006650020

Nm	■	D mm	A mm	L mm	g
60÷330	1/2	40	43	590	1260

665/30 CHF 386.00 1 006650030



Beta

665LB

Clé dynamométrique mécanique à écran digital avec cliquet réversible, pour serrages à droite, précision de serrage $\pm 3\%$

- Unité de mesure : pied-livre-force
- Réglage et lecture simple du couple par le biais de la valeur affichée sur l'écran
- L'écran d'affichage reste éclairé avec la valeur de couple programmée
- Lecture du couple avec nombre décimal
- Extinction automatique après 30 secondes avec réglage du couple inférieur au seuil minimum
- Alimentation avec 1 batterie de 3 V (incluse)



UNI EN ISO 6789

lb.f.ft	mm	D mm	A mm	L mm	g
7÷45	3/8	30	33	335	655

665LB/6 CHF 310.00 1 006650106

lb.f.ft	mm	D mm	A mm	L mm	g
15÷75	3/8	30	33	375	725

665LB/10 CHF 312.00 1 006650110

lb.f.ft	mm	D mm	A mm	L mm	g
15÷75	1/2	30	37	375	725

665LB/10X CHF 319.00 1 006650111

lb.f.ft	mm	D mm	A mm	L mm	g
30÷150	1/2	40	43	470	995

665LB/20 CHF 340.00 1 006650120

lb.f.ft	mm	D mm	A mm	L mm	g
45÷240	1/2	40	43	590	1260

665LB/30 CHF 386.00 1 006650130

665SW

Boîtier d'étalonnage

- Ce boîtier permet l'étalonnage des clés dynamométriques 665 avec l'aide des contrôleurs de couples 680 et 682, sans avoir à démonter la clé.
- L'étalonnage advient sur plusieurs points pour compenser le comportement non linéaire du ressort.
- Doté de prise Micro USB pour permettre d'éventuelles mises à jour du logiciel



665SW CHF 31.00 1 006650100

666N CLÉS DYNAMOMÉTRIQUE À CLIC



17 dents en prise permettent une excellente répartition de l'effort



Échelle augmentée améliorant la lecture et la précision de réglage



Matériaux des poignées et du cadran en verre résistants à toutes les substances chimiques utilisées dans le secteur automobile, l'industrie et l'aviation.



Vitesse de réglage du couple rapide
Le joint torique de couleur rouge permet d'indiquer que la clé est déverrouillée et que le couple peut être ajusté.

666N

Clé dynamométrique à déclenchement avec cliquet réversible pour serrage à droite
Précision de serrage: $\pm 3\%$



UNI EN ISO 6789

Nm	Kgfm	lb.f.ft	mm	D mm	A mm	L mm	g
5÷25	0,5÷2,5	4÷18	1/4	25	29	220	300

666N/2 CHF 419.00 1 006660002

Nm	Kgfm	lb.f.ft	mm	D mm	A mm	L mm	g
5÷25	0,5÷2,5	4÷18	3/8	25	29	220	300

666N/2X CHF 427.00 1 006660003

Nm	Kgfm	lb.f.ft	mm	D mm	A mm	L mm	g
10÷50	1÷5	7÷37	3/8	30	33	325	660

666N/5 CHF 310.00 1 006660005

Nm	Kgfm	lb.f.ft	mm	D mm	A mm	L mm	g
20÷100	2÷10	15÷75	3/8	30	33	367	730

666N/10 CHF 312.00 1 006660010

Nm	Kgfm	lb.f.ft	mm	D mm	A mm	L mm	g
20÷100	2÷10	15÷75	1/2	30	37	367	800

666N/10X CHF 319.00 1 006660011

Nm	Kgfm	lb.f.ft	mm	D mm	A mm	L mm	g
40÷200	4÷20	30÷150	1/2	40	43	465	1010

666N/20 CHF 340.00 1 006660020

Nm	Kgfm	lb.f.ft	mm	D mm	A mm	L mm	g
60÷300	6÷30	50÷220	1/2	40	43	581	1380

666N/30 CHF 386.00 1 006660030



666N LBF.IN

Clé dynamométrique à déclenchement avec cliquet réversible pour serrage à droite
Précision de serrage : $\pm 3\%$
• Échelle en livres-force par pouces



UNI EN ISO 6789

lbf.in	■	D mm	A mm	L mm	g
90÷440	3/8	30	33	325	660

CHF		1	006660055
666N-LBF.IN/5	310.00		

lbf.in	■	D mm	A mm	L mm	g
200÷900	3/8	30	33	367	730

CHF		1	006660070
666N-LBF.IN/10	312.00		

lbf.in	■	D mm	A mm	L mm	g
200÷900	1/2	30	37	367	800

CHF		1	006660071
666N-LBF.IN/10X	319.00		

lbf.in	■	D mm	A mm	L mm	g
400÷1800	1/2	40	43	465	1010

CHF		1	006660072
666N-LBF.IN/20	340.00		

lbf.in	■	D mm	A mm	L mm	g
500÷3000	1/2	40	43	581	1380

CHF		1	006660073
666N-LBF.IN/30	386.00		

667N

Clé dynamométrique à déclenchement avec cliquet réversible à glissière utilisable pour serrage droite ou gauche
Précision de serrage: $\pm 3\%$

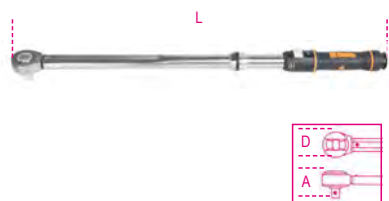

UNI EN ISO 6789

Nm	Kgfm	lbf.ft	■	D mm	A mm	L mm	g
40÷200	4÷20	30÷150	1/2	40	43	465	1010

CHF		1	006670020
667N/20	334.00		

Nm	Kgfm	lbf.ft	■	D mm	A mm	L mm	g
60÷300	6÷30	50÷220	1/2	40	43	581	1380

CHF		1	006670030
667N/30	372.00		

Nm	Kgfm	lbf.ft	■	D mm	A mm	L mm	g
80÷400	8÷40	60÷295	3/4	50	50	687	2090

CHF		1	006670040
667N/40	894.00		

Voir le tableau après la ref. 928/C8 pour les pièces détachées du mécanisme de la tête de la clé dynamométrique

668N

Clé dynamométrique à attachement à déclenchement utilisable pour serrage droite ou gauche
Précision de serrage : $\pm 3\%$



UNI EN ISO 6789

Nm	Kgfm	lbf.ft	Ø mm	L mm	LB mm	LS mm	g
5÷25	0,5÷2,5	4÷18	16	220	148	32	300

CHF		1	006680002
668N/2	312.00		

Nm	Kgfm	lbf.ft	Ø mm	L mm	LB mm	LS mm	g
10÷50	1÷5	7÷37	16	307	229	32	590

CHF		1	006680005
668N/5	306.00		

Nm	Kgfm	lbf.ft	Ø mm	L mm	LB mm	LS mm	g
20÷100	2÷10	15÷75	16	376	269	32	670

CHF		1	006680010
668N/10	312.00		

Nm	Kgfm	lbf.ft	Ø mm	L mm	LB mm	LS mm	g
40÷200	4÷20	30÷150	16	450	352,6	32	795

CHF		1	006680020
668N/20	340.00		

Nm	Kgfm	lbf.ft	Ø mm	L mm	LB mm	LS mm	g
60÷300	6÷30	50÷220	16	588	475,9	32	1230

CHF		1	006680030
668N/30	386.00		

668RG

Clé dynamométrique à attachement à déclenchement utilisable pour serrage droite ou gauche
Précision de serrage : $\pm 4\%$
(S'utilise avec les articles 680 - 682)



UNI EN ISO 6789

Nm	Kgfm	lbf.ft	Ø mm	L mm	g
8÷60	0,8÷6	6÷44	16	288	550

CHF		1	006680206
668RG/6	252.00		

Nm	Kgfm	lbf.ft	Ø mm	L mm	g
20÷100	2÷10	15÷80	16	315	600

CHF		1	006680210
668RG/10	259.00		

Nm	Kgfm	lbf.ft	Ø mm	L mm	g
40÷200	4÷20	30÷150	16	405	780

CHF		1	006680220
668RG/20	276.00		

Nm	Kgfm	lbf.ft	Ø mm	L mm	g
60÷300	6÷30	50÷220	16	645	1130

CHF		1	006680230
668RG/30	308.00		

668RGC

Clé dynamométrique à attachement à déclenchement, mono-couple, utilisable pour serrage droite, précision de serrage : $\pm 4\%$
(s'utilise avec les articles 680/40 - 682)



UNI EN ISO 6789

Nm	Kgfm	lbf.in	■	D mm	A mm	L mm	g
12÷60	1,2÷6	5÷45	3/8	30	33	295	600

CHF		1	006680406
668RGC/6	229.50		

Nm	Kgfm	lbf.in	■	D mm	A mm	L mm	g
20÷100	2÷10	15÷75	3/8	30	33	335	700

CHF		1	006680410
668RGC/10	240.00		

Nm	Kgfm	lbf.in	■	D mm	A mm	L mm	g
20÷100	2÷10	15÷75	1/2	40	43	342	700

CHF		1	006680411
668RGC/10X	240.00		

Nm	Kgfm	lbf.in	■	D mm	A mm	L mm	g
40÷200	4÷20	30÷150	1/2	40	43	425	1000

CHF		1	006680420
668RGC/20	245.00		



669N

Clé dynamométrique à attachement à déclenchement, embout rectangulaire utilisable par serrage droite ou gauche
Précision de serrage: $\pm 3\%$



UNI EN ISO 6789

Nm	Kgfm	lbf.ft	□ mm	L mm	LB mm	LS mm	g
5÷25	0,5÷2,5	4÷18	9x12	215	140	28,8	300

669N/2 CHF 445.00 1 006690202

Nm	Kgfm	lbf.ft	□ mm	L mm	LB mm	LS mm	g
10÷50	1÷5	7÷37	9x12	307	226,8	28,8	590

669N/5 CHF 342.00 1 006690205

Nm	Kgfm	lbf.ft	□ mm	L mm	LB mm	LS mm	g
20÷100	2÷10	15÷75	9x12	376	266,8	28,8	670

669N/10 CHF 368.00 1 006690210

Nm	Kgfm	lbf.ft	□ mm	L mm	LB mm	LS mm	g
40÷200	4÷20	30÷150	9x12	450	345,6	28,8	795

669N/20 CHF 441.00 1 006690220

Nm	Kgfm	lbf.ft	□ mm	L mm	LB mm	LS mm	g
40÷200	4÷20	30÷150	14x18	450	351	39,8	795

669N/20X CHF 466.00 1 006690221

Nm	Kgfm	lbf.ft	□ mm	L mm	LB mm	LS mm	g
60÷300	6÷30	50÷220	14x18	588	468,5	39,8	1230

669N/30 CHF 492.00 1 006690230

Nm	Kgfm	lbf.ft	□ mm	L mm	LB mm	LS mm	g
80÷400	8÷40	60÷295	14x18	664	563	39,8	2100

669N/40 CHF 567.00 1 006690240

671B/C5

Clé dynamométrique 604B/5 et accessoires

14" ø8



671B/C5 CHF 1,245.00 1 006710001

604B/5	1÷5 Nm
611	1/4
641	5-6-7-8 mm
900	4-5-5,5-6-7-8-9-10 mm

270x120x45 mm - 1,3 kg

671B/C10

Clé dynamométrique 604B/10 et accessoires

14" ø8



671B/C10 CHF 1,245.00 1 006710002

604B/10	2÷10 Nm
611	1/4
641	6-7-8-10 mm
900	4-5-5,5-6-7-8-9-10 mm

270x120x45 mm - 1,4 kg

671N/C10

Clé dynamométrique 668N/10 et accessoires

3/8" ø16



671N/C10 CHF 1,405.00 1 006710110

668N/10	100 Nm
612	3/8
617	3/8
642	10-13-14-17-19 mm
652	10-13-14-17-19 mm
910A	3/8 8-10-11-13-14-17-19 mm
910/21	125 mm
910/22	250 mm

400x180x45 mm - 4,3 kg

671N/C20

Clé dynamométrique 668N/20 et accessoires

12" ø16



671N/C20 CHF 1,485.00 1 006710120

668N/20	200 Nm
614	1/2
619	1/2
642	10-13-14-17-19 mm
652	10-13-14-17-19 mm
920A	1/2 10-11-13-14-17-19-22 mm
920/20	75 mm
920/21	125 mm
920/22	255 mm

510x180x45 mm - 5,5 kg

671N/C30

Clé dynamométrique 668N/30 et accessoires

12" ø16



671N/C30 CHF 1,400.00 1 006710130

668N/30	300 Nm
614	1/2
619	1/2
642	13-14-17-19 mm
652	13-14-17-19 mm
920A	1/2 13-14-17-19-22-24-27 mm
920/20	75 mm
920/21	125 mm
920/22	255 mm

620x180x45 mm - 5,8 kg

Beta

Beta

674/C

Clé dynamométrique à déclenchement, embout rond Ø 22 mm, pour serrage à droite et à gauche, précision du couple: ± 4%,



UNI EN ISO 6789

Nm	Kgfm	lbf.ft	Ø mm	L mm	LB mm	LS mm	kg
100÷500	10÷50	80÷400	22	786	725	56	3,4

	CHF		
674/C50	1,032.00	1	006740005

Nm	Kgfm	lbf.ft	Ø mm	L mm	LB mm	LS mm	kg
160÷800	16÷80	120÷600	22	997	915	56	4,5

	CHF		
674/C80	1,094.00	1	006740008

Nm	Kgfm	lbf.ft	Ø mm	L mm	LB mm	LS mm	kg
200÷1000	20÷100	150÷750	22	997	915	56	4,5

	CHF		
674/C100	1,109.00	1	006740010

677

Clé dynamométrique à cassure avec cliquet simple Utilisable pour le serrage à droite et à gauche Précision de serrage : ± 4 %



UNI EN ISO 6789

Nm	Kgfm	lbf.ft	D mm	A mm	L mm	kg
120÷600	12÷60	100÷450	69	55	1059	6,0

	CHF		
677/600	1,156.00	1	006770006

Nm	Kgfm	lbf.ft	D mm	A mm	L mm	kg
200÷800	20÷80	150÷600	69	55	1319	6,7

	CHF		
677/800	1,210.00	1	006770008

Nm	Kgfm	lbf.ft	D mm	A mm	L mm	kg
300÷1000	30÷100	200÷750	69	55	1554	7,4

	CHF		
677/1000	1,295.00	1	006770010

677/C

Clé dynamométrique à cassure avec cliquet réversible à glissière utilisable pour serrage droite ou gauche précision de serrage : ± 4% en coffret



UNI EN ISO 6789

Nm	Kgfm	lbf.ft	D mm	A mm	L mm	kg
120÷600	12÷60	100÷450	69	55	1059	6,0

	CHF		
677/C600	1,365.00	1	006770607

Nm	Kgfm	lbf.ft	D mm	A mm	L mm	kg
200÷800	20÷80	150÷600	69	55	1319	6,7

	CHF		
677/C800	1,420.00	1	006770612

Nm	Kgfm	lbf.ft	D mm	A mm	L mm	kg
300÷1000	30÷100	200÷750	69	55	1554	7,4

	CHF		
677/C1000	1,505.00	1	006770616

Nm	Kgfm	lbf.ft	D mm	A mm	L mm	kg
700÷1500	70÷150	500÷1000	69	55	1869	9,6

	CHF		
677/C1500	1,930.00	1	006770621

677/CP2000

clés dynamométriques à cassure avec cliquets réversible à glissière, utilisable pour serrage à droite et à gauche, Précision du couple : ± 4% en coffret



UNI EN ISO 6789

Nm	Kgfm	lbf.ft	D mm	A mm	L mm	kg
900÷2000	90÷200	700÷1500	69	63	1940	12,75

	CHF		
677/CP2000	3,530.00	1	006770721

678/C

Clé dynamométrique à déclenchement avec cliquet réversible à glissière utilisable pour serrage droite ou gauche, précision de serrage : ± 4% en coffret

• Modèles 678/C100 et 678/C150 fournis avec rallonge

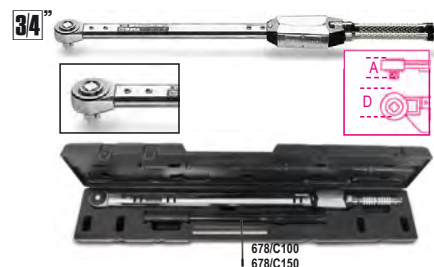

UNI EN ISO 6789

Nm	Kgfm	lbf.ft	D mm	A mm	L mm	kg
130÷650	13÷65	100÷480	63	55	885	3,9

	CHF		
678/C65	2,130.00	1	006780607

Nm	Kgfm	lbf.ft	D mm	A mm	L mm	kg
300÷1000	30÷100	220÷750	75	60	1250	6,0

	CHF		
678/C100	2,830.00	1	006780611

Nm	Kgfm	lbf.ft	D mm	A mm	L mm	kg
500÷1500	50÷150	370÷1100	75	60	1570	8,5

	CHF		
678/C150	3,080.00	1	006780615

677/CV - 678/CV

Coffret vide pour clé dynamométrique 677 et 678



	CHF		
677/CVN1	210.00	1	006770455

	CHF		
677/CVN2	276.00	1	006770460

	CHF		
678/CV1	198.50	1	006780455

	CHF		
678/CV2	223.00	1	006780500

	CHF		
678/CV3	368.00	1	006780415

677/C100-677/C150-678/C150

Couplemètre électronique numérique Dynatester 680 pour vérifier les étalonnages fonctionnement à droite et à gauche

- Précision de lecture : ± 1 % de la lecture
- Écran LCD couleur, 4 chiffres
- 3 unités de mesure : Nm - lbf.ft. - lbf.in



	Nm	kg	CHF		
680/3	0,1÷3	1,4	3,620.00	1	006800000
680/30	1,5÷30	1,4	3,570.00	1	006800003
680/350	10÷350	2,6	3,580.00	1	006800035
680/2100	200÷2100	3,5	5,330.00	1	006800210

Contrôleur de couple électronique digital Avec transducteur Dynatester 682 fonctionnant dans les 2 sens Haute précision de lecture Fourni avec sortie série RS 232



CARACTERISTIQUES TECHNIQUES
 Précision de lecture ±1% de la valeur affichée
 Unités de mesures possibles Nm-dNm-cNm-lbf.ft-lbf.in-Ozf.in-Kgf.m-Kgf.cm-gf.cm
 Alimentation de 90 à 264 Vc.a. à 50/60 Hz
 Dimensions 235x185x185 mm
 Test de tolérance selon la norme ISO 6789
 Contrôle des clés suivant la norme ISO 6789
 Définition de la tolérance selon la norme pour chaque type d'outil
 Affichage
 Menu disponible en 11 langues
 Livré avec tous les certificats obligatoires
 Certificats d'étalonnage avec traçabilité UKAS

	Nm	kg	CHF		
682/60	1,2÷60	5,9	7,400.00	1	006820006
682/400	8÷400	6,1	7,510.00	1	006820040
682/1500	30÷1500	6,4	7,750.00	1	006820150

DOUILLES À CHOCS



Les douilles à chocs sont surdimensionnées par rapport aux douilles à main, afin qu'elles puissent résister à des couples élevés tel que ceux développés par les clés à chocs et les multiplicateurs de couple.

Le profil **hexagonal** offre une durée de vie accrue après une utilisation intensive. Elles doivent être utilisées avec des goupilles et des bagues de sécurité afin d'empêcher le désaccouplement avec l'outil utilisé.

En plus des modèles classiques en versions standard et longue, une série longue et fine est également disponible. Elles sont utilisées dans les espaces où les vis ne sont pas accessibles avec les modèles standard. Il faut cependant être prudent lors de leur utilisation car elles sont plus fragile que les versions standards.



Douille à chocs, série normale



UNI/ISO 2725 DIN 3129

mm	Ø mm	L mm	Ø1 mm	CHF		
7	12,5	28	19	10.90	3	007100007
8	13,8	28	19	10.90	3	007100008
9	15,0	28	19	10.90	3	007100009
10	16,3	28	19	10.90	3	007100010
11	17,5	30	19	10.90	3	007100011
12	19,0	30	19	10.90	3	007100012
13	20,0	30	22	11.40	3	007100013
14	21,3	30	22	11.40	3	007100014
16	23,8	30	22	11.60	3	007100016
17	25,0	30	22	11.60	3	007100017
18	26,3	30	22	11.90	3	007100018
19	27,5	30	22	11.90	3	007100019
21	30,0	32	22	13.20	3	007100021
22	32,0	32	22	14.60	3	007100022

710/C10

10 douilles à chocs



	CHF		
710/C10	153.50	1	007100910

130x55x40 mm - 800 g

710/16

Augmentateur carré femelle 3/8" et mâle 1/2"



L mm	Ø mm	CHF		
32	22	29.50	3	007100810

710/20

Rallonge carrés mâle et femelle 3/8"



L mm	Ø mm	CHF		
75	22	30.00	2	007100821

710/21

Rallonge carrés mâle et femelle 3/8"



L mm	Ø mm	CHF	🔧	📄
125	22	33.00	2	007100823

710/22

Rallonge à chocs carrés mâle et femelle 3/8"



L mm	Ø mm	CHF	🔧	📄
150	22	38.50	2	007100825

710/25

Cardan carrés mâle et femelle 3/8"



L mm	Ø mm	CHF	🔧	📄
58	24	60.50	2	007100830

710/OR... - 710/SP...

Bague en caoutchouc et goupille de sécurité pour douille et accessoires à chocs



	710 mm	710/16 L mm	CHF	🔧	📄
710/OR1	7+12		0.91	10	007100921
710/OR2	13+22	32	0.91	10	007100922
710/SP1	7+12		1.67	10	007100911
710/SP2	13+22	32	1.67	10	007100912



720

Douille à chocs, série normale



UNI/ISO 2725 DIN 3129

Ø mm	Ø mm	L mm	Ø1 mm	CHF	🔧	📄
8	15,0	38	25	13.00	5	007200008
9	16,0	38	25	13.00	5	007200009
10	17,0	38	25	13.30	5	007200010
11	18,5	38	25	13.30	5	007200011
12	20,0	38	25	13.30	5	007200012
13	21,0	38	25	13.30	5	007200013
14	22,5	38	25	13.30	5	007200014
15	23,0	38	30	14.90	5	007200015
16	25,0	38	30	14.90	5	007200016
17	26,0	38	30	14.90	5	007200017
18	27,5	38	30	14.90	5	007200018
19	28,5	38	30	14.90	5	007200019
20	30	38	30	16.40	5	007200020
21	31,0	38	30	16.40	5	007200021
22	32,5	38	30	16.60	5	007200022
23	34,0	38	30	18.10	5	007200023
24	35,0	38	30	18.10	5	007200024
27	38,5	45	30	21.10	3	007200027
29	41	47	30	23.10	3	007200029
30	42,0	50	30	23.10	3	007200030
32	44,0	50	30	26.50	3	007200032
36	50,0	50	30	38.00	3	007200036

720/C6

6 Douilles à chocs



720/C6	CHF	🔧	📄
13-14-17-19-22-24 mm	122.00	1	007200910

195x80x55 mm - 1100 g

720/C12

12 Douilles à chocs



720/C12	CHF	🔧	📄
10-11-12-13-14-17-19-22-24-27-30-32 mm	232.50	1	007200912

195x80x55 mm - 2000 g

720/C24

24 douilles à chocs



720/C24	CHF	🔧	📄
	523.00	1	007200904

720	10 - 12 - 13 - 14 - 15 - 16 - 17 - 18 - 19 - 21 - 22 - 24 - 27 - 30 - 32 mm
720L	13 - 17 - 19 - 21 - 22 - 24 mm
720LC	17 - 19 - 21 mm

420x185x60 mm - 6,2 kg

720MC

Douille à chocs, série normale, colorée



Ø mm	Ø mm	L mm	CHF	🔧	📄
10	17,0	38	13.80	3	007202010
11	18,5	38	13.80	3	007202011
12	20,0	38	13.80	3	007202012
13	21,0	38	13.80	3	007202013
14	22,5	38	13.80	3	007202014
15	23,0	38	15.50	3	007202015
16	25,0	38	15.50	3	007202016
17	26,0	38	15.50	3	007202017
18	27,5	38	15.50	3	007202018
19	28,5	38	15.50	3	007202019
21	31,0	38	17.20	2	007202021
22	32,5	38	17.20	2	007202022
24	35,0	38	18.90	2	007202024

720MC/C13

13 douilles à chocs colorées



720MC/C13	CHF	🔧	📄
10-11-12-13-14-15-16-17-18-19-21-22 mm	249.00	1	007202913

335x145x60 mm - 2,4 kg

720B

Douille à chocs
12 pans



UNI/ISO 2725 DIN 3129

mm	Ø mm	L mm	Ø1 mm	CHF		
10	17	38	25	13.30	5	007201010
11	18	38	25	13.30	5	007201011
12	19	38	25	13.30	5	007201012
13	20	38	25	13.30	5	007201013
14	22	38	25	13.30	5	007201014
15	23	38	30	14.90	5	007201015
16	24	38	30	14.90	5	007201016
17	26	38	30	14.90	5	007201017
18	27	38	30	14.90	5	007201018
19	28	38	30	14.90	5	007201019
21	30	38	30	16.40	5	007201021
22	31,8	38	30	16.60	5	007201022
23	31,8	38	30	18.10	5	007201023
24	33,8	40	30	18.10	5	007201024
27	37,8	43	30	21.10	3	007201027
30	41,8	43	30	23.10	3	007201030
32	43,8	43	30	26.50	3	007201032
36	49,8	50	30	38.00	3	007201036

720AS

Douille à chocs, série normale



mm	Ø mm	L mm	Ø1 mm	CHF		
3/8	17,0	38	25	21.50	2	007200210
7/16	18,2	38	25	21.50	2	007200211
1/2	20,7	38	25	21.50	2	007200213
9/16	22,0	38	25	21.50	2	007200214
5/8	24,5	38	30	23.10	2	007200216
11/16	25,7	38	30	23.10	2	007200217
3/4	28,2	38	30	23.10	2	007200219
13/16	30,7	38	30	24.40	2	007200221
7/8	32,0	38	30	24.40	2	007200222
15/16	34,5	38	30	26.00	2	007200224
1	35,7	38	30	28.00	2	007200225
1.1/16	38,2	40	30	31.00	1	007200227
1.1/8	40,7	42	30	34.50	1	007200229
1.1/4	44,5	42	30	38.50	1	007200232

720S

Douille à chocs,
série compacte



mm	Ø mm	L mm	Ø1 mm	CHF		
13	20,0	28,0	23,8	8.30	3	007200113
15	23,0	28,0	23,8	8.30	3	007200115
17	25,8	28,0	25,8	9.05	3	007200117
19	27,8	28,0	27,8	9.85	3	007200119
22	31,8	28,0	30,0	10.70	3	007200122
24	33,8	28,0	30,0	11.70	3	007200124



720S/SB6 CHF 70.50 1 007200906
13-15-17-19-22-24 mm

720L

Douille à chocs longue



UNI/ISO 2725

mm	Ø mm	L mm	Ø1 mm	CHF		
10	17,0	80	25	22.70	2	007200310
11	18,5	80	25	22.70	2	007200311
12	20,0	80	25	22.70	2	007200312
13	21,0	80	25	22.70	2	007200313
14	22,5	80	25	22.70	2	007200314
15	23,0	80	30	26.00	2	007200315
16	25,0	80	30	26.00	2	007200316
17	26,0	80	30	26.00	2	007200317
18	27,5	80	30	27.00	2	007200318
19	28,5	80	30	27.00	2	007200319
21	31,0	80	30	29.00	2	007200321
22	32,5	80	30	29.00	2	007200322
24	35,0	80	30	30.00	2	007200324
27	38,5	80	30	38.00	2	007200327
30	42,0	80	30	46.00	2	007200330
32	44,0	80	30	46.00	2	007200332
36	50,0	80	30	59.00	2	007200336

720L/S3

Jeu de 3 douilles à chocs 720L



17-19-21 CHF 82.00 1 007200355

720LS

Douille à chocs,
série longue et fine



mm	Ø mm	L mm	Ø1 mm	CHF		
10	15,5	78	24	24.40	2	007200360
11	16,7	78	24	24.40	2	007200361
12	18,0	78	24	24.40	2	007200362
13	19,2	78	24	24.40	2	007200363
14	20,5	78	24	24.40	2	007200364
15	21,7	78	24	25.00	2	007200365
16	23,0	78	24	25.00	2	007200366
17	24,2	78	29	28.00	2	007200367
18	25,5	78	29	30.00	2	007200368
19	26,7	78	29	30.00	2	007200369
21	29,2	78	29	31.50	2	007200371
22	30,5	78	29	31.50	2	007200372
24	33,0	78	29	32.00	2	007200374
27	36,7	78	29	39.50	2	007200377
30	40,5	78	29	50.00	2	007200380
32	43,0	78	29	52.00	2	007200382
36	48,0	78	29	78.00	2	007200386

720LC

Douilles à chocs gainées pour écrous de
roues
en alliage léger



mm	Ø mm	CHF		
17	26,5	16.40	2	007200637
19	28,5	16.40	2	007200639
21	30,3	17.00	2	007200641
22	32,4	17.70	2	007200642
24	34,6	19.20	2	007200644



720LC/C3 CHF 49.50 1 007200653
17-19-21 mm
148x132x44 mm - 860 g



720LC/S5 CHF 87.00 1 007200645
17-19-21-22-24 mm



720LC/PM5 CHF 142.50 1 007200646
17-19-21-22-24 mm

PM 1/2-Q5

Rail magnétique porte douilles



PM 1/2-Q5 CHF 56.00 1 088880233

720IC

Embouts polymères colorés pour douilles à chocs 720LC-720LCL



mm	CHF	12"	1	007200687
720IC 17	6.60		1	007200687
720IC 19	6.60		1	007200689
720IC 21	6.60		1	007200691
720IC 22	6.60		1	007200692
720IC 24	6.60		1	007200694

Beta
Quality Tools

720LCL

Douille à chocs colorées, série longue, avec embouts polymères pour écrous de roues



mm	Ø mm	CHF	12"	1	007200737
17	26,5	27.00		1	007200737
19	28,5	27.00		1	007200739
21	30,3	27.00		1	007200741



720LCL/C3 CHF 103.50 1 007200753

210x50x150 mm - 1,65 kg

720MRC

Douille à chocs avec embout polymère pour vis roue avec profil Mercedes

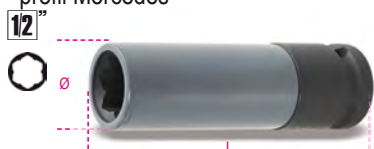

mm	Ø mm	L mm	CHF	12"	1	007200631
17	27	85	26.00		1	007200631

720FRD

Douille à chocs pour écrous de roue Ford présentant un revêtement en aluminium endommagé

Indispensable quand la tête de l'écrou est endommagée par la clé à chocs



mm	L mm	CHF	12"	1	007200633
18,5=19,5	63	24.80		1	007200633

720TC

Douille à chocs colorée à contrôle de couple



Nm	L mm	CHF	12"	1	007200769
90	200	28.00		1	007200769
100	200	28.00		1	007200770
110	200	28.00		1	007200771
120	200	28.00		1	007200772
135	200	28.00		1	007200773



720TC/S5 CHF 141.50 1 007200779

260x50x175 mm - 1,35 kg

720FTX

Douille à chocs pour écrous Torx®



Ø mm	L mm	Ø1 mm	CHF	12"	2	007200410
E10	14,0	38	21.20		2	007200410
E12	15,9	38	21.20		2	007200412
E14	17,7	38	21.20		2	007200414
E16	20,0	38	21.20		2	007200416
E18	22,0	38	21.20		2	007200418
E20	25,0	40	22.60		2	007200420
E24	30,0	40	22.60		2	007200424



720FTX/SB6 CHF 141.50 1 007200450

E10-E12-E14
E16-E18-E20

720TX

Douille tournevis à chocs pour vis Torx®



Ø mm	L mm	L1 mm	CHF	12"	3	007200460
T30	25	78	18.60		3	007200460
T40	25	78	18.60		3	007200470
T45	25	78	19.00		3	007200472
T50	25	78	19.00		3	007200474
T55	25	78	21.50		3	007200476
T60	25	78	23.10		3	007200478

720TX/C6

Jeu de 6 douilles à chocs 720TX en coffret métallique



720TX/C6 CHF 157.00 1 007200483

T30-T40-T45
T50-T55-T60

275x120x65 mm - 5700 g

720ME

Douille tournevis à chocs pour vis 6 pans creux

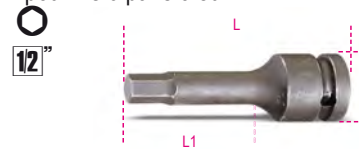

mm	Ø mm	L mm	L1 mm	CHF	12"	3	007200505
5	25	78	54	17.90		3	007200505
6	25	78	54	17.90		3	007200506
8	25	78	54	17.90		3	007200508
10	25	78	54	17.90		3	007200510
12	25	78	54	17.90		3	007200512
14	25	78	54	20.00		3	007200514
17	25	78	54	20.00		3	007200517
19	25	78	54	20.00		3	007200519

720ME/C8

Jeu de 8 douilles à chocs 720ME



720ME/C8 CHF 192.00 1 007200525

5-6-8-10-12
14-17-19 mm

270x120x45 mm - 1710 g

9899 720ME/C8 CHF 16.40 1 098990130

Plateau thermoformé vide

720XZN

Douille mâle à chocs pour vis XZN®



Ø	Ø mm	L mm	L1 mm	CHF	3	007201504
M4	25	77	53	20.20	3	007201504
M5	25	77	53	20.20	3	007201505
M6	25	77	53	20.20	3	007201506
M8	25	77	53	20.20	3	007201508
M10	25	77	53	20.70	3	007201510
M12	25	77	53	21.20	3	007201512
M14	25	77	53	21.20	3	007201514
M16	25	77	53	21.70	3	007201516
M18	25	77	53	22.80	3	007201518

720/15

Réducteur carré femelle 1/2" et mâle 3/8"



L mm	Ø mm	1/2"	3/8"	CHF	3	007200810
37,5	25	1/2	3/8	14.90	3	007200810



Toujours appliquer la force de serrage régulièrement et progressivement afin d'éviter la rupture et de se protéger contre un possible accident.

720/16

Augmentateur carré femelle 1/2" et mâle 3/4"



L mm	Ø mm	1/2"	3/4"	CHF	3	007200814
44	30	1/2	3/4	25.50	3	007200814

720/20

Rallonge carrés mâle et femelle 1/2"



L mm	Ø mm	CHF	3	007200818
75	25	26.50	3	007200818

720/21

Rallonge carrés mâle et femelle 1/2"



L mm	Ø mm	CHF	3	007200822
125	25	28.50	3	007200822

720/22

Rallonge à chocs carrés mâle et femelle 1/2"



L mm	Ø mm	CHF	3	007200824
250	25	33.50	3	007200824

720/25

Cardan carrés mâle et femelle 1/2"



L mm	Ø mm	CHF	2	007200831
64	28	49.00	2	007200831

720/OR... - 720/SP...

Bague en caoutchouc et goupille de sécurité pour douille et accessoires à choc



	720	720TX	CHF	10	007200923
720/OR1	10÷14	T30÷T60	1.70	10	007200923
720/OR2	15÷36		1.70	10	007200924
720/SP1	10÷14	T30÷T60	2.51	10	007200913
720/SP2	15÷36		2.51	10	007200914

727PI/16 1/2

Douille porte-embouts à chocs pour 727/ES16, 727/ES16TX et 727/ES16XZN



Ø mm	L mm	Ø mm	1/2"	CHF	2	007270015
28	42	16	1/2	44.00	2	007270015

727PI/16

Douille porte-embouts à chocs pour articles 727/ES16 et 727/ES16TX



Ø mm	L mm	Ø mm	3/4"	CHF	2	007270016
44	52	16	3/4	57.50	2	007270016

727/ES16

Embout à chocs pour vis 6 pans creux avec entraînement 16 mm



mm	Ø mm	L mm	CHF	2	007270110
10	16	40	19.50	2	007270110
12	16	40	19.50	2	007270112
13	16	40	19.50	2	007270113
14	16	40	19.50	2	007270114
16	16	40	21.00	2	007270116
17	16	40	21.00	2	007270117
18	16	40	21.80	2	007270118
19	16	40	21.80	2	007270119
22	16	40	25.00	2	007270122

727/ES16TX

Embout à choc pour vis Torx® avec entraînement 16mm



Ø mm	Ø mm	L mm	CHF	2	007270355
T55	16	50	29.50	2	007270355
T60	16	50	29.50	2	007270360
T70	16	50	29.50	2	007270370



727PI/22

Douille porte-embouts à chocs pour articles 727/ES22 et 727/ES22TX

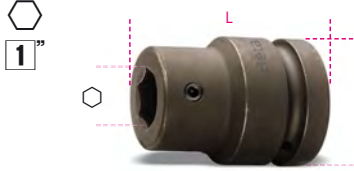

Ø mm	L mm	Ø mm	CHF	Icon	Icon
54	70	22	89.00	2	007270022

727/ES22

Embout à chocs pour vis 6 pans creux avec entraînement 22 mm



mm	Ø mm	L mm	CHF	Icon	Icon
19	22	50	25.00	2	007270219
22	22	50	25.00	2	007270222
24	22	50	27.50	2	007270224
27	22	50	31.00	2	007270227
30	22	50	37.00	2	007270230
32	22	50	40.50	2	007270232

727/ES22TX

Embout à choc pour vis Torx® avec entraînement 22 mm



Icon	mm	L mm	CHF	Icon	Icon
T80	22	60	41.00	2	007270480
T90	22	60	41.00	2	007270490
T100	22	60	41.00	2	007270500

727/C16

12 embouts à chocs et 4 accessoires



727/C16	CHF	Icon	Icon
	560.00	1	007270900

- 727PI/16
- 727/ES16 14-17-19 mm
- 727/ES16TX T55-T60-T70
- 727PI/22
- 727/ES22 22-24-27 mm
- 727/ES22TX T80-T90-T100
- 96BPC 3-4 mm

335x145x60 mm - 3,6 kg

727PI/32

Douille porte-embouts à choc pour article 727/ES32

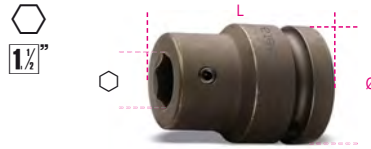

Ø mm	L mm	Ø mm	CHF	Icon	Icon
86	66	32	222.00	1	007270032

727/ES32

Embout à choc pour vis 6 pans creux, avec entraînement 32 mm



mm	Ø mm	L mm	CHF	Icon	Icon
19	32	44	57.00	2	007270519
22	32	44	57.00	2	007270522
24	32	44	57.00	2	007270524
27	32	44	57.00	2	007270527
30	32	44	57.00	2	007270530
32	32	44	57.00	2	007270532
36	32	44	64.00	2	007270536

728

Douille à chocs, série normale



UNI/ISO 2725 DIN 3129

Icon	mm	Ø mm	L mm	Ø1 mm	CHF	Icon	Icon
	17	30,0	51	44	33.00	2	007280017
	18	31,0	51	44	33.00	2	007280018
	19	32,5	51	44	33.00	2	007280019
	21	35,0	51	44	33.00	2	007280021
	22	36,0	51	44	33.00	2	007280022
	23	37,5	51	44	33.50	2	007280023
	24	38,5	51	44	33.50	2	007280024
	27	42,5	53	44	33.50	2	007280027
	28	44,0	53	44	34.00	2	007280028
	30	46,0	53	44	35.50	2	007280030
	32	48,5	57	44	37.00	2	007280032
	33	50,0	57	44	39.50	2	007280033
	34	51,0	57	44	39.50	2	007280034
	35	52,5	57	44	41.00	2	007280035
	36	53,5	57	44	42.00	2	007280036
	38	56,0	57	44	47.00	1	007280038
	40	58,5	58	44	50.00	1	007280040
	41	60,0	58	44	51.00	1	007280041
	44	64,0	62	44	55.00	1	007280044
	45	65,0	62	44	59.50	1	007280045
	46	66,0	62	44	60.00	1	007280046
	50	71,0	68	54	70.50	1	007280050
	55	77,5	71	54	78.50	1	007280055
	60	83,0	73	54	90.00	1	007280060
	65	88,0	78	54	100.00	1	007280065



728/C10

10 douilles à chocs



728/C10	CHF	Icon	Icon
17-19-22-24-27-30 32-36-41-46 mm	429.00	1	007280910

275x120x65 mm - 5,7 kg

728B

Douille à chocs 12 pans



UNI/ISO 2725 DIN 3129

Icon	mm	Ø mm	L mm	Ø1 mm	CHF	Icon	Icon
	17	28,5	50	38	33.00	2	007280117
	19	30	52	38	33.00	2	007280119
	21	32	52	38	33.00	2	007280121
	22	34	52	38	33.00	2	007280122
	23	35	52	38	33.50	2	007280123
	24	36	52	38	33.50	2	007280124
	27	40	52	40	33.50	2	007280127
	29	42	52	42	34.50	2	007280129
	30	44	52	44	35.50	2	007280130
	32	48	52	44	37.00	2	007280132
	33	50	56	44	39.50	2	007280133
	34	51	56	44	39.50	2	007280134
	35	52	56	44	41.00	2	007280135
	36	53,5	56	44	42.00	2	007280136
	38	56	56	44	47.00	1	007280138
	41	60	58	44	51.00	1	007280141
	46	67	63	44	60.00	1	007280146

728AS

Douille à chocs, série normale



Icon	mm	Ø mm	L mm	Ø1 mm	CHF	Icon	Icon
	3/4	32,0	51	41	33.00	1	007280219
	13/16	35,0	51	41	33.50	1	007280221
	7/8	36,0	51	41	33.50	1	007280222
	15/16	38,5	51	41	33.50	1	007280224
	1	40,0	53	41	34.00	1	007280225
	1.1/16	42,5	53	44	36.50	1	007280227
	1.1/8	44,0	53	44	37.00	1	007280230
	1.1/4	48,5	57	44	38.00	1	007280232
	1.5/16	50,0	57	44	39.50	1	007280233
	1.7/16	53,5	57	44	42.00	1	007280236
	1.1/2	56,0	57	44	46.50	1	007280238
	1.5/8	60,0	58	44	51.00	1	007280241

728FTX

Douille à chocs pour écrous Torx®



	Ø mm	L mm	Ø1 mm	CHF		
E20	28,5	50	44	44.00	2	007280420
E22	30,0	50	44	44.00	2	007280422
E24	32,5	50	44	44.00	2	007280424

728ME

Douille mâle à chocs
6 pans



	Ø mm	L mm	L1 mm	CHF		
12	44	100	67	38.50	3	007280712
14	44	100	67	42.50	3	007280714
17	44	100	67	42.50	3	007280717
19	44	100	67	42.50	3	007280719
22	44	100	67	50.00	3	007280722
24	44	100	67	50.00	3	007280724

728L

Douille à chocs,
série longue



	Ø mm	L mm	Ø1 mm	CHF		
17	30	90	44	52.00	2	007280317
19	32,5	90	44	52.00	2	007280319
21	35,0	90	44	52.00	2	007280321
22	36,0	90	44	52.00	2	007280322
24	38,5	90	44	52.00	2	007280324
26	41,0	90	44	52.00	2	007280326
27	42,5	90	44	52.00	2	007280327
30	46,0	90	44	54.00	2	007280330
32	48,5	90	44	57.00	2	007280332
33	50,0	90	44	60.50	1	007280333
34	51,0	90	44	64.50	1	007280334
36	53,5	90	44	67.00	1	007280336
38	56,0	90	44	78.00	1	007280338
41	60,0	90	44	80.00	1	007280341
44	64,0	90	44	91.50	1	007280344
46	66,0	90	44	91.50	1	007280346
50	71,0	90	44	109.50	1	007280350
55	77,5	100	54	144.50	1	007280355



	CHF		
728L/S3 Ø 30-32-36 mm	178.00	1	007280393

728LS

Douille à chocs, série longue et fine



	Ø mm	L mm	Ø1 mm	CHF		
17	28,0	100	43	59.00	2	007280517
19	30,5	100	43	59.00	2	007280519
22	34,3	100	43	60.00	2	007280522
24	36,8	100	43	60.00	2	007280524
27	40,5	100	43	60.00	2	007280527
30	44,3	100	43	60.00	2	007280530
32	46,8	100	43	64.50	2	007280532
33	48,0	100	43	66.50	2	007280533
36	51,8	100	43	77.50	1	007280536

728LQ

Douille à chocs, série longue

(pour écrous de roues ISUZU)



	L mm	Ø mm	Ø1 mm	CHF		
19	90	35	43,5	52.50	1	007280619
21	90	42	43,5	52.50	1	007280621

728/15

Réducteur carré femelle 3/4"
et mâle 1/2"



	L mm	Ø mm	CHF		
58	38	3/4 1/2	41.00	2	007280810



Toujours appliquer la force de serrage
régulièrement et progressivement
afin d'éviter la rupture et de se protéger
contre un possible accident.

728/16

Augmentateur carré femelle 3/4"
et mâle 1"



	L mm	Ø mm	CHF		
62	44	3/4 1	49.50	2	007280813

728/21

Rallonge carrés mâle et femelle 3/4"



	L mm	Ø mm	CHF		
175	44		60.50	2	007280815

728/22

Rallonge carrés mâle et femelle 3/4"



	L mm	Ø mm	CHF		
250	44		70.00	2	007280825

728/22L

Rallonge à chocs carrés
mâle et femelle 3/4"



	L mm	Ø mm	CHF		
330	44		90.00	1	007280826

728/25

Cardan carrés mâle et femelle 3/4"



	L mm	Ø mm	CHF		
107,5	44		118.50	1	007280830

728/OR - 728/SP

Bague en caoutchouc et goupille
de sécurité pour douille et accessoires
à chocs



	728 mm	728FTX mm	CHF		
728/OR	728/15		2.50	5	007280925
728/OR	17+46	E20+E24	2.66	10	007280926
728/SP	17+46	E20+E24	3.50	10	007280916

729

Douille à chocs, série normale



UNI/ISO 2725 DIN 3129

	Ø mm	L mm	Ø1 mm	CHF		
24	41,5	58	54	52.50	1	007290024
27	45,0	60	54	52.50	1	007290027
30	49,0	62	54	52.50	1	007290030
32	51,5	63	54	54.00	1	007290032
33	52,5	63	54	54.00	1	007290033
34	54,0	63	54	54.00	1	007290034
36	56,5	66	54	54.00	1	007290036
38	59,0	66	54	65.00	1	007290038
41	62,5	68	54	66.50	1	007290041
46	69,0	72	54	74.50	1	007290046
50	74,0	76	54	91.50	1	007290050
55	80,0	84	54	98.00	1	007290055
60	86,5	88	54	118.50	1	007290060
65	92,5	92	54	135.50	1	007290065
70	99,0	96	54	174.00	1	007290070
75	105,0	102	63	203.50	1	007290075
80	111,5	102	63	219.00	1	007290080

729L

Douille à chocs, série longue



Ø mm	Ø mm	L mm	Ø1 mm	CHF	1	1007290324
24	41,5	108	54	93.50	1	1007290324
27	45,0	108	54	93.50	1	1007290327
30	49,0	108	54	93.50	1	1007290330
32	51,5	108	54	93.50	1	1007290332
33	52,2	108	54	95.00	1	1007290333
34	54,0	108	54	95.00	1	1007290334
36	56,5	108	54	95.00	1	1007290336
41	62,5	108	54	113.00	1	1007290341
46	69,0	108	54	131.00	1	1007290346
50	74,0	108	54	146.50	1	1007290350
55	80,0	108	54	175.50	1	1007290355
60	86,5	108	54	189.50	1	1007290360
65	92,5	108	54	228.50	1	1007290365
70	99,0	108	54	260.00	1	1007290370
75	105,0	108	63	294.00	1	1007290375
80	111,5	108	63	309.00	1	1007290380

729LS

Douille à choc, série longue et fine



Ø mm	Ø mm	L mm	Ø1 mm	CHF	1	1007290522
22	36,0	108	53	93.50	1	1007290522
24	38,5	108	53	93.50	1	1007290524
27	46,0	108	53	93.50	1	1007290527
30	50,0	108	53	99.00	1	1007290530
32	50,0	108	53	99.00	1	1007290532
33	52,0	108	53	99.00	1	1007290533
36	56,0	108	53	99.00	1	1007290536

729T

Douille à choc à contrôle de couple



Ø mm	Nm	L mm	CHF	1	1007290724
24	350	300	180.00	1	1007290724
27	450	300	180.00	1	1007290757
30	500	300	181.50	1	1007290730
32	450	300	184.50	1	1007290732
32	600	300	184.50	1	1007290762
33	600	300	193.50	1	1007290763
36	600	300	205.00	1	1007290736

729/15

Réducteur carré femelle 1" et mâle 3/4"



L mm	Ø mm	CHF	1	1007290810
66,5	54	62.50	1	1007290810



Toujours appliquer la force de serrage régulièrement et progressivement afin d'éviter la rupture et de se protéger contre un possible accident.

729/16

Réducteur carré femelle 1" et mâle 1.1/2"



L mm	Ø mm	CHF	1	1007290813
88	54,0	103.00	1	1007290813

729/21

Rallonge carrés mâle et femelle 1"



L mm	Ø mm	CHF	1	1007290815
175	54	96.00	1	1007290815

729/21L

Rallonge à chocs carrés mâle et femelle 1"



L mm	Ø mm	CHF	1	1007290826
250	54	117.00	1	1007290826

729/22

Rallonge carrés mâle et femelle 1"



L mm	Ø mm	CHF	1	1007290825
330	54	137.50	1	1007290825

729/25

Cardan carrés mâle et femelle 1"



L mm	Ø mm	CHF	1	1007290830
130	54	199.00	1	1007290830

729/OR... - 729/SP...

Bague en caoutchouc et goupille de sécurité pour douille et accessoires à chocs



729/OR1	728 mm 50+60	729-730 mm 24+70	CHF	5	007290927
729/OR2		75+125	4.20	5	007290928
729/SP1	50+60	24+70	2.56	5	007290917
729/SP2		75+125	4.20	5	007290918

730

Douille à chocs, série normale



UNI/ISO 2725 DIN 3129

Ø mm	Ø mm	L mm	Ø1 mm	CHF	1	1007300050
50	81	87	84	274.00	1	1007300050
55	88	90	86	281.00	1	1007300055
60	94	95	86	310.00	1	1007300060
65	100	100	86	340.00	1	1007300065
70	106	105	86	402.00	1	1007300070
75	113	110	86	466.00	1	1007300075
80	119	115	86	533.00	1	1007300080
85	125	120	86	590.00	1	1007300085
90	132	125	86	672.00	1	1007300090
95	138	125	96	782.00	1	1007300095
100	144	130	96	909.00	1	1007300100
105	150	135	96	1,013.00	1	1007300105
110	157	140	96	1,101.00	1	1007300110
115	163	140	96	1,184.00	1	1007300115
120	169	145	96	1,325.00	1	1007300120
125	175	145	96	1,380.00	1	1007300125

730L

Douille à chocs, série longue



Ø mm	Ø mm	L mm	Ø1 mm	CHF	1	1007300350
50	81	135	86	438.00	1	1007300350
55	87	140	86	449.00	1	1007300355
60	93	150	86	497.00	1	1007300360
65	97	150	86	544.00	1	1007300365
70	105	160	86	644.00	1	1007300370
75	110	170	86	746.00	1	1007300375
80	116	170	86	854.00	1	1007300380
85	125	170	86	945.00	1	1007300385
90	130	170	86	1,075.00	1	1007300390
95	137	180	95	1,250.00	1	1007300395
100	144	190	95	1,455.00	1	1007300400
105	150	190	95	1,620.00	1	1007300405
110	156	200	95	1,760.00	1	1007300410
115	160	200	95	1,895.00	1	1007300415
120	168	210	95	2,120.00	1	1007300420

730/15 Réducteur



! Toujours appliquer la force de serrage régulièrement et progressivement afin d'éviter la rupture et de se protéger contre un possible accident.

730/21

Rallonge à chocs carrés mâle et femelle 1.1/2"



730/25

Cardan à chocs carrés mâle et femelle 1.1/2"



733/15 Réducteur

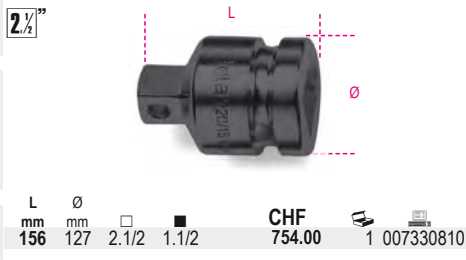

EMBOUTS

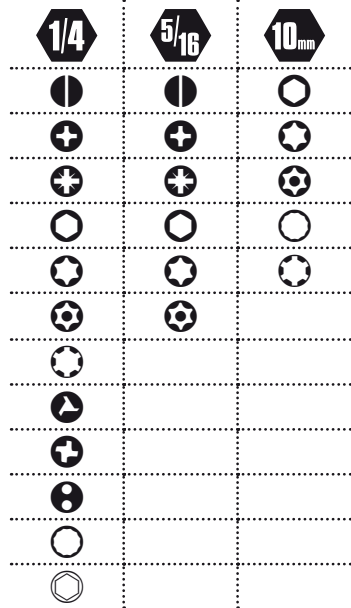

ISO 1173-C 6,3



emmenchement simple

ISO 1173-E 6,3



fente pour maintien embout

851

Poignée porte-embouts magnétique

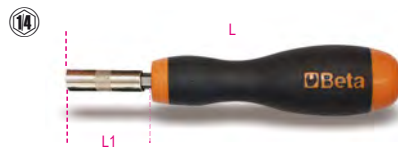

L1 mm	L mm	CHF	2	008510165
45	165	20.70	2	008510165
125	245	24.10	2	008510245

851SR

Poignée porte-embouts à bague de déverrouillage rapide



L mm	L1 mm	CHF	2	008510001
230	110	28.50	2	008510001

852

Porte-embouts à cardan

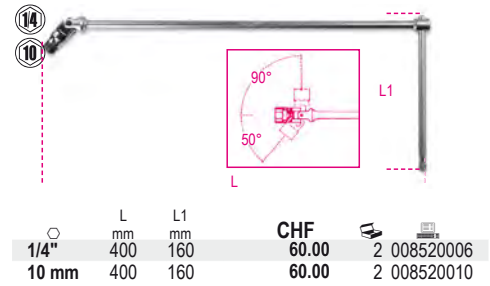

855P

Porte-embouts à cliquet réversible avec poignée articulée et 7 embouts incorporés

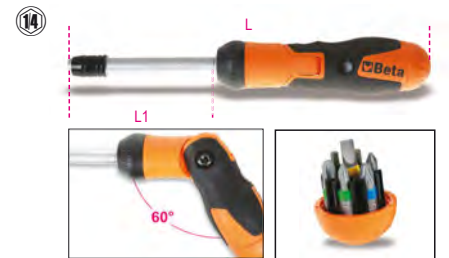

L mm	L1 mm	CHF	1	008550010
240	100	94.00	1	008550010

- 860PH PH1 - PH2
- 860PZ PZ1 - PZ2
- 860LP LP 0,8X5,5 mm
- 860PE 4 - 5 mm

860LP

Embout coloré pour visseuses pour vis à fente



ISO 2351-1
ISO 1173 C 6,3

SxA mm	L mm	CHF	5	008600005
0,5x3	25	2.47	5	008600010
0,6x4,5	25	2.47	5	008600015
0,8x5,5	25	2.47	5	008600020
1x5,5	25	2.47	5	008600025
1,2x6,5	25	2.47	5	008600025

860PH

Embout coloré pour visseuses pour vis Phillips®



ISO 2351-2
ISO 1173 C 6,3

PH	L mm	CHF	5	008600220
0	25	2.47	5	008600225
1	25	2.47	5	008600230
2	25	2.47	5	008600245
3	25	2.47	5	008600250
4	25	3.60	5	008600250



860PZ

Embout coloré pour visseuses pour vis Pozidriv® - Supadriv®



ISO 2351-2
ISO 1173 C 6,3

PZ	L mm	CHF	Hand	Code
1	25	2.47	5	008600320
2	25	2.47	5	008600325
3	25	2.47	5	008600330
4	25	3.60	5	008600335

860PE

Embout coloré pour visseuses pour vis 6 pans creux



ISO 2351-3
ISO 1173 C 6,3

mm	L mm	CHF	Hand	Code
2	25	2.63	5	008600101
2,5	25	2.63	5	008600102
3	25	2.63	5	008600103
4	25	2.63	5	008600104
5	25	2.63	5	008600105
6	25	2.63	5	008600106
8	25	3.30	5	008600108
10	25	3.30	5	008600110

860TX

Embout coloré pour visseuses pour vis Torx®



ISO 1173 C 6,3

T	L mm	CHF	Hand	Code
T6	25	3.30	5	008600704
T7	25	3.30	5	008600705
T8	25	3.30	5	008600710
T9	25	3.30	5	008600715
T10	25	2.63	5	008600720
T15	25	2.63	5	008600725
T20	25	2.63	5	008600730
T25	25	2.63	5	008600735
T27	25	2.63	5	008600740
T30	25	2.63	5	008600745
T40	25	2.63	5	008600750

860RTX

Embout coloré pour visseuses pour vis Tamper Resistant Torx®



ISO 1173 C 6,3

T	L mm	CHF	Hand	Code
T9	25	3.60	5	008600550
T10	25	3.60	5	008600555
T15	25	3.60	5	008600560
T20	25	3.60	5	008600565
T25	25	3.60	5	008600570
T27	25	3.60	5	008600575
T30	25	3.60	5	008600580
T40	25	3.60	5	008600585

860/55

Cliquet réversible porte-embouts



L mm 100
Ø 1/4
CHF 42.00
3 008600870

860/58

Cliquet porte-embouts à manche rotatif

- L'embout peut être inséré sur les deux côtés pour visser ou dévisser
- Manche bi-matières

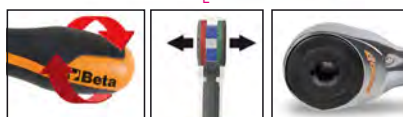

L mm 126
Ø 1/4
A mm 27 15
CHF 96.50
1 008600884

860/C27

Jeu de 25 embouts pour visseuses, 1 porte-douilles et 1 cliquet réversible en étui de poche



860/C27 CHF 114.50
1 008600880

860/55	100 mm
860LP	0,5x3-1,0x5,5-1,2x6,5 mm
860PH	PH1-PH2(x2)-PH3
860PZ	PZ1-PZ2(x2)-PZ3
860PE	2-2,5-3-4-5-6 mm
860TX	T6-T8-T10-T15-T20-T25-T30-T40
892/0	● 1/4 ■ 1/4

860PHZ/A10

Coffret de 11 pièces



860PHZ/A10 CHF 47.00
1 008600910

860PH	PH1 PH2 PH3	1 3 1
860PZ	PZ1 PZ2 PZ3	1 3 1
882M1	○ 1/4 ● 1/4	

860PE/A10

Coffret de 11 pièces



860PE/A10 CHF 49.50
1 008600920

860PE	2-2,5 mm	n.
882M1	3-4-5-6 mm	1
	○ 1/4 ● 1/4	2

860TX/A10

Coffret de 11 pièces



860TX/A10 CHF 51.00
1 008600970

860TX	T7 - T8 - T9 - T10 - T15 - T20	1
882M1	T25 - T27 - T30 - T40	
	○ 1/4 ● 1/4	

860MIX/A10

Jeu de 10 embouts pour visseuses et 1 porte-douilles magnétique, en étui de poche



860MIX/A10 CHF 47.00
1 008600900

860LP	0,5x3 - 1x5,5 - 1,2x6,5 mm	1
860PH	PH1 PH2 PH3	1 2 1
860PZ	PZ1 - PZ2 - PZ3	1
882M1	○ 1/4 ● 1/4	



860MIX/A31

Coffret de 31 pièces

Jeu de 31 embouts pour visseuses et 1 porte-douilles magnétique, en étui de poche



860MIX/A31 CHF 112.00 1 008600902

	860LP	0,5x3 - 0,6x4,5 - 0,8x5,5 1,0x5,5 - 1,2x6,5 mm
	860PE	2 - 2,5 - 3 - 4 - 5 - 6 8 - 10 mm
	860PH	PH0 - PH1 - PH2 - PH3 - PH4
	860PZ	PZ1 - PZ2 - PZ3 - PZ4
	860RTX	T9 - T10 - T15 - T20 T25 - T27 - T30 - T40
	862MSR 50	○ 1/4 ● 1/4

860/C38P

Composition de 1 poignée porte-embouts avec cliquet réversible, 27 embouts pour visseuses, 8 douilles 6 pans et 2 accessoires



860/C38P CHF 249.00 1 008600878

	860LP	0,6x4,5-0,8x5,5-1,0x5,5- 1,2x6,5 mm
	860PE	2-2,5-3-4(x2)-5(x2) mm
	860PH	PH1(x2)-PH2(x2)-PH3
	860PZ	PZ1(x2)-PZ2(x2)-PZ3
	860TX	T10-T15-T20-T25-T30-T40
	900	5-5,5-6-7-8-9-10-13 mm
	892/0	● 1/4 ■ 1/4
	892/3	● 1/4 ■ 1/4
	855P	240 mm

270x120x45 mm

861LP

Embout pour visseuses pour vis à fente



ISO 2351-1

ISO 1173 C 6,3

SxA mm	L mm	CHF	📦	🏠
0,5x3	25	1.60	10	008610005
0,6x4	25	1.60	10	008610007
0,6x4,5	25	1.60	10	008610010
0,8x5,5	25	1.60	10	008610015
1x5,5	25	1.60	10	008610020
1,2x6,5	25	1.60	10	008610025
1,2x8	25	3.05	10	008610028
1,6x8	25	3.05	10	008610030

861PH

Embout pour visseuses pour vis Phillips®



ISO 2351-2

ISO 1173 C 6,3

PH	L mm	CHF	📦	🏠
0	25	1.58	10	008610200
1	25	1.58	10	008610205
2	25	1.58	10	008610210
2L	50	3.05	10	008610213
3	25	1.58	10	008610215
4	25	4.20	10	008610220

861PH/C

Embout pour visseuses pour vis Phillips®

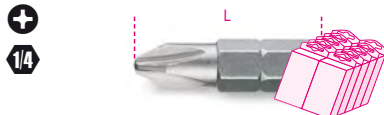

ISO 2351-2

ISO 1173 C 6,3

PH	L mm	CHF	📦	🏠
0	25	1.21	200	008610250
1	25	1.21	200	008610255
2	25	1.21	200	008610260
2L	50	2.31	100	008610263
3	25	1.21	200	008610265
4	25	3.10	100	008610270

861PZ

Embout pour visseuses pour vis Pozidriv® -Supadriv®



ISO 2351-2

ISO 1173 C 6,3

PZ	L mm	CHF	📦	🏠
1	25	1.58	10	008610300
2	25	1.58	10	008610305
2L	50	3.05	10	008610308
3	25	1.58	10	008610310
4	25	4.20	10	008610315

861PZ/C

Embout pour visseuses pour vis Pozidriv® -Supadriv®



ISO 2351-2

ISO 1173 C 6,3

PZ	L mm	CHF	📦	🏠
1	25	1.21	200	008610350
2	25	1.21	200	008610355
2L	50	2.31	100	008610358
3	25	1.21	200	008610360
4	25	3.05	100	008610365

861PE

Embout pour visseuses pour vis 6 pans creux



ISO 2351-3

ISO 1173 C 6,3

mm	L mm	CHF	📦	🏠
2	25	1.69	10	008610100
2,5	25	1.69	10	008610105
3	25	1.69	10	008610110
4	25	1.69	10	008610115
5	25	1.69	10	008610120
6	25	1.69	10	008610125
8	25	2.55	10	008610130
10	25	3.35	10	008610135

861TX

Embout pour visseuses pour vis Torx®



ISO 1173 C 6,3

T	L mm	CHF	📦	🏠
T5	25	2.24	10	008610399
T6	25	2.24	10	008610400
T7	25	2.24	10	008610405
T8	25	2.24	10	008610410
T9	25	2.24	10	008610415
T10	25	1.77	10	008610420
T15	25	1.77	10	008610425
T20	25	1.77	10	008610430
T25	25	1.77	10	008610435
T27	25	1.77	10	008610440
T30	25	1.77	10	008610445
T40	25	1.77	10	008610450



861TX/C

Embout pour visseuses pour vis Torx®

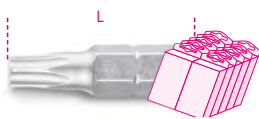

ISO 1173 C 6,3

	L mm	CHF		
T10	25	1.36	200	008610470
T15	25	1.36	200	008610475
T20	25	1.36	200	008610480
T25	25	1.36	200	008610485
T27	25	1.36	200	008610490
T30	25	1.36	200	008610495
T40	25	1.36	200	008610499

861RTX

Embout pour visseuses pour vis à Tamper Resistant Torx(R)



ISO 1173 C 6,3

	L mm	CHF		
T6	25	3.30	10	008610537
T7	25	3.30	10	008610538
T8	25	3.30	10	008610540
T9	25	3.30	10	008610500
T10	25	3.30	10	008610505
T15	25	3.30	10	008610510
T20	25	3.30	10	008610515
T25	25	3.30	10	008610520
T27	25	3.30	10	008610525
T30	25	3.30	10	008610530
T40	25	3.30	10	008610535
T45	25	6.40	10	008610539

861RIBE

Embout pour visseuses pour vis RIBE® multipans



ISO 1173 C 6,3

	L mm	CHF		
M5	25	1.44	10	008610705
M6	25	1.44	10	008610706
M7	25	1.77	10	008610707
M8	25	1.77	10	008610708
M9	25	2.55	10	008610709

861TRW

Embout pour visseuses pour vis Tri-Wing(R)



ISO 1173 C 6,3

GR	L mm	CHF		
1	25	2.81	10	008610601
2	25	2.81	10	008610602
3	25	2.81	10	008610603
4	25	2.81	10	008610604
5	25	2.81	10	008610605
6	25	4.10	10	008610606

861TQS

Embout pour visseuses pour vis Torq-Set(R)



ISO 1173 C 6,3

GR	L mm	CHF		
0	25	2.81	10	008610620
1	25	2.81	10	008610621
2	25	2.81	10	008610622
3	25	2.81	10	008610623
4	25	2.81	10	008610624
5	25	2.81	10	008610625
6	25	2.81	10	008610626
8	25	2.81	10	008610628
10	25	2.81	10	008610630

861SP

Embout pour visseuses pour vis Spanner



ISO 1173 C 6,3

SP	D mm	L mm	CHF		
4	1,5	25	2.31	10	008610650
6	2,4	25	2.31	10	008610653
8	2,8	25	2.31	10	008610656
10	3,3	25	2.31	10	008610658
12	3,9	25	2.31	10	008610660

1483KV-PT/S7



1483KV PT/S7

188

861XZN

Embout pour visseuses pour vis XZN®



ISO 1173 C 6,3

	L mm	CHF		
M5	25	1.44	10	008610725
M6	25	1.44	10	008610726
M8	25	1.85	10	008610728

861/C61P

Coffret de 61 embouts pour visseuses avec 1 porte-embouts à bague de déverrouillage rapide



861/C61P CHF 215.00 1 008610978

	861LP	0,5x3 - 0,6x4,5 - 0,8x5,5 - 1,0x5,5 - 1,2x6,5 - 1,2x8 - 1,6x8 mm
	861PE	2 - 2,5 - 3 - 4 - 5 - 6 - 8 - 10 mm
	861PH	PH0 - PH1 - PH2 - PH3
	861PZ	PZ1 - PZ2 - PZ3
	861TX	T6 - T7 - T8 - T9 - T10 - T15 - T20 - T25 - T27 - T30 - T40
	861RTX	T9 - T10 - T15 - T20 - T25 - T27 - T30 - T40
	861TRW	1 - 2 - 3 - 4 - 5 - 6
	861TQS	0 - 1 - 2 - 3 - 4 - 5 - 6 - 8 - 10
	861SP	4 - 6 - 8 - 10 - 12
	851SR	1/4"

270x120x45 mm - 975 g

862LP

Embout pour visseuses pour vis à fente



ISO 2351-1

ISO 1173 E 6,3

SxA mm	L mm	CHF		
0,5x3	50	4.60	5	008620005
0,6x4,5	50	4.60	5	008620010
0,8x5,5	50	4.60	5	008620015
1x5,5	50	4.60	5	008620020
1,2x6,5	50	4.60	5	008620025
1,2x8	50	5.70	5	008620030
1,6x8	50	5.70	5	008620035

862PH

Embout pour visseuses pour vis Phillips®



ISO 2351-2

ISO 1173 E 6,3

PH	L mm	CHF		
1	50	4.60	5	008620200
2	50	4.60	5	008620205
3	50	4.60	5	008620210



862PH/L

Embout pour visseuses pour vis Phillips®



ISO 2351-2

ISO 1173 E 6,3

PH	L mm	CHF		
1	70	8.45	5	008620230
2	70	8.45	5	008620232
3	70	8.45	5	008620234

862PH-XL

Embout pour visseuses pour vis Phillips®



ISO 2351-2/ISO 1173 E 6,3

PH	L mm	CHF		
1	100	8.70	5	008620250
2	100	8.70	5	008620252
3	100	8.70	5	008620254

862PZ

Embout pour visseuses pour vis Pozidriv® -Supadriv®



ISO 2351-2

ISO 1173 E 6,3

PZ	L mm	CHF		
1	50	4.70	5	008620300
2	50	4.70	5	008620305
3	50	4.70	5	008620310

862PE

Embout pour visseuses pour vis 6 pans creux



ISO 2351-3

ISO 1173 E 6,3

mm	L mm	CHF		
3	50	4.70	5	008620103
4	50	4.70	5	008620104
5	50	4.70	5	008620105
6	50	4.70	5	008620106
8	50	6.40	5	008620108

862TX

Embout pour visseuses pour vis Torx®



ISO 1173 E 6,3

	L mm	CHF		
T6	50	6.35	5	008620506
T7	50	6.35	5	008620507
T8	50	6.35	5	008620508
T9	50	6.35	5	008620509
T10	50	6.35	5	008620510
T15	50	6.35	5	008620515
T20	50	6.35	5	008620520
T25	50	6.35	5	008620525
T27	50	6.35	5	008620527
T30	50	6.35	5	008620530
T40	50	6.35	5	008620540

862TX/L

Embout pour visseuses pour vis Torx®



ISO 1173 E 6,3

	L mm	CHF		
T6	70	6.80	5	008620556
T7	70	6.80	5	008620557
T8	70	6.80	5	008620558
T9	70	6.80	5	008620559
T10	70	6.80	5	008620560
T15	70	6.80	5	008620565
T20	70	6.80	5	008620570
T25	70	6.80	5	008620575
T27	70	6.80	5	008620577
T30	70	6.80	5	008620580
T40	70	6.80	5	008620590

862TX-XL

Embout pour visseuses pour vis Torx®



ISO 1173 E 6,3

	L mm	CHF		
T9	100	7.50	5	008620659
T10	100	7.50	5	008620660
T15	100	7.50	5	008620665
T20	100	7.50	5	008620670
T25	100	7.50	5	008620675
T27	100	7.50	5	008620677
T30	100	7.50	5	008620680
T40	100	7.50	5	008620690

862F

Embout à douille magnétique pour visseuse



ISO 1173 E 6,3

mm	L mm	∅ mm	CHF		
5,5	65	11	8.60	5	008620405
6	65	11	8.60	5	008620406
7	65	11	8.60	5	008620407
8	65	13	8.60	5	008620408
10	65	15	9.35	5	008620410
12	65	18	10.40	5	008620412
13	65	18	10.90	5	008620413

862F/A7

Jeu de 7 embouts à douille magnétique pour visseuses en étui de poche



862F/A7	CHF		
	65.00	1	008620950

862F 5,5-6-7-8-10-12-13 mm

866LP

Embout pour visseuses pour vis à fente



ISO 2351-1
ISO 1173 C 8

SxA mm	L mm	CHF		
1x5,5	41	4.70	10	008660005
1,2x6,5	41	4.70	10	008660010
1,6x8	41	4.70	10	008660015
1,6x10	41	6.40	10	008660020
2x12	41	8.00	10	008660025

866PH

Embout pour visseuses pour vis Phillips®



ISO 2351-2

ISO 1173 C 8

PH	L mm	CHF		
1	32	3.85	10	008660200
2	32	3.85	10	008660205
3	32	3.85	10	008660210
4	38	5.75	10	008660215

866PZ

Embout pour visseuses pour vis Pozidriv® -Supadriv®



ISO 2351-2

ISO 1173 C 8

PZ	L mm	CHF		
1	32	4.05	10	008660300
2	32	4.05	10	008660305
3	32	4.05	10	008660310
4	38	6.00	10	008660315

866PE

Embout pour visseuses pour vis 6 pans creux



ISO 2351-3

ISO 1173 C 8

mm	L mm	CHF		
3	30	3.30	10	008660100
4	30	3.30	10	008660105
5	30	3.30	10	008660110
6	30	3.30	10	008660115
7	30	3.30	10	008660117
8	30	3.30	10	008660120
10	30	4.60	10	008660125
12	30	6.40	10	008660132
14	30	8.25	10	008660134

866TX

Embout pour visseuses pour vis TORX®



ISO 1173 C 8

	L mm	CHF		
T20	30	4.15	10	008660400
T25	30	4.15	10	008660405
T27	30	4.15	10	008660410
T30	30	4.15	10	008660415
T40	30	4.15	10	008660420
T45	30	4.15	10	008660425
T50	30	4.15	10	008660430
T55	30	5.95	10	008660435
T60	30	8.00	10	008660440
T70	30	8.85	10	008660445

866RTX

Embout pour visseuses pour vis à Tamper Resistant Torx(R)



ISO 1173 C 8

	L mm	CHF		
T40	30	4.70	10	008660520
T45	30	4.70	10	008660525
T50	30	4.70	10	008660530
T55	30	6.65	10	008660535
T60	30	8.60	10	008660540
T70	30	10.70	10	008660545

867PE

Embout avec entraînement hexagonal de 10mm pour vis 6 pans creux



mm	L mm	CHF		
4	30	2.16	5	008670104
5	30	2.16	5	008670105
6	30	2.16	5	008670106
7	30	2.16	5	008670107
8	30	2.16	5	008670108
10	30	2.16	5	008670110
12	30	3.20	5	008670112

867PE/L

Embout avec entraînement hexagonal de 10 mm pour vis 6 pans creux série longue



mm	L mm	CHF		
4	75	4.05	5	008670154
5	75	4.05	5	008670155
6	75	4.05	5	008670156
7	75	4.05	5	008670157
8	75	4.05	5	008670158
10	75	4.05	5	008670160
12	75	5.65	5	008670162

867XZN

Embout avec entraînement hexagonal de 10 mm pour vis XZN®



	L mm	CHF		
M4	30	2.71	5	008670204
M5	30	2.71	5	008670205
M6	30	2.71	5	008670206
M8	30	2.71	5	008670208
M10	30	2.71	5	008670210
M12	30	4.05	5	008670212

867XZN/L

Embout avec entraînement hexagonal de 10 mm pour vis XZN(R) - série longue



	L mm	CHF		
M5	75	4.40	5	008670255
M6	75	4.40	5	008670256
M8	75	4.40	5	008670258
M10	75	4.40	5	008670260
M12	75	6.00	5	008670262

867TX

Embout avec entraînement hexagonal de 10 mm pour vis Torx®



	L mm	CHF		
T20	30	2.16	5	008670400
T25	30	2.16	5	008670405
T30	30	2.16	5	008670410
T40	30	2.16	5	008670415
T45	30	2.16	5	008670420
T50	30	2.16	5	008670425
T55	30	2.16	5	008670430

867TX/L

Embout avec entraînement hexagonal de 10 mm pour vis Torx® série longue



	L mm	CHF		
T20	75	3.55	5	008670450
T25	75	3.55	5	008670455
T30	75	3.55	5	008670460
T40	75	3.55	5	008670465
T45	75	3.55	5	008670470
T50	75	3.55	5	008670475
T55	75	3.55	5	008670480

867RTX

Embout avec entraînement hexagonal de 10 mm pour vis Tamper Resistant Torx(R)



	L mm	CHF		
T20	30	2.41	5	008670500
T25	30	2.41	5	008670505
T30	30	2.41	5	008670510
T40	30	2.41	5	008670515
T45	30	2.41	5	008670520
T50	30	2.41	5	008670525
T55	30	2.41	5	008670530

867RTX/L

Embout avec entraînement hexagonal de 10 mm pour vis Tamper Resistant Torx® - série longue



	L mm	CHF		
T20	75	4.05	5	008670550
T25	75	4.05	5	008670555
T30	75	4.05	5	008670560
T40	75	4.05	5	008670565
T45	75	4.05	5	008670570
T50	75	4.05	5	008670575
T55	75	4.05	5	008670580

867RIBE

Embout pour visseuses pour vis RIBE®



	L mm	CHF		
M5	30	2.47	5	008670705
M6	30	2.47	5	008670706
M7	30	2.47	5	008670707
M8	30	2.47	5	008670708
M9	30	2.47	5	008670709
M10	30	2.47	5	008670710
M11	30	3.60	5	008670711
M12	30	3.60	5	008670712
M13	30	3.60	5	008670713

867RIBE/L

Embout pour visseuses pour vis RIBE®



	L mm	CHF		
M5	75	4.05	5	008670755
M6	75	4.05	5	008670756
M7	75	4.05	5	008670757
M8	75	4.05	5	008670758
M9	75	4.05	5	008670759
M10	75	4.05	5	008670760
M11	75	5.45	5	008670761
M12	75	5.45	5	008670762
M13	75	5.45	5	008670763

867/...

Douille porte-embouts pour 867



	mm	mm	L mm	mm	CHF		
867/1	10	3/8"	38	17	7.75	5	008670600
867/2	10	1/2"	38	22	8.75	5	008670601

867/C20

18 embouts pour visseuses pour vis RIBE® avec entraînement hexagonal 10 mm et 2 accessoires



867/C20	CHF		
	154.50	1	008670920

	867RIBE	5-6-7-8-9-10-11-12-13 mm
	867RIBE/L	5-6-7-8-9-10-11-12-13 mm
	867/1	
	867/2	

335x145x60 mm - 1,7 kg

867/C38

38 embouts avec entraînement hexagonal de 10 mm et 1 porte-embouts à cardan



867/C38	CHF		
	284.00	1	008670938

	852	10 mm
	867PE	4-5-6-7-8-10-12mm
	867PE/L	4-5-6-7-8-10-12mm
	867XZN	M5-M6-M8-M10-M12
	867XZN/L	M5-M6-M8-M10-M12
	867TX	T20-T25-T30-T40-T45-T50-T55
	867TX/L	T20-T25-T30-T40-T45-T50-T55
	882	

420x185x60 mm - 3 kg

867/C52

Coffret de 52 embouts avec entraînement hexagonal de 10 mm et 2 accessoires



867/C52	CHF		
	175.00	1	008670901

	867PE	4-5-6-7-8-10-12 mm
	867PE/L	4-5-6-7-8-10-12 mm
	867XZN	M5-M6-M8-M10-M12
	867XZN/L	M5-M6-M8-M10-M12
	867TX	T20-T25-T30-T40-T45-T50-T55
	867TX/L	T20-T25-T30-T40-T45-T50-T55
	867RTX	T20-T25-T30-T40-T45-T50-T55
	867RTX/L	T20-T25-T30-T40-T45-T50-T55
	867/1	○ 10 mm - □ 3/8"
	867/2	○ 10 mm - □ 1/2"

250x170x70 mm - 2,1 kg

852



852	78,116
-----	--------

882

Porte-embouts avec anneau de retenue pour visseuses



ISO 1173 E 6,3

L mm	mm	mm	mm	CHF		
57	1/4	1/4	11	21.50	5	008820001

882AN

Renvoi d'angle coupleur hexagonal 1/4"

- Pour perceuses électriques avec mandrin de 10 et 13 mm et clés à chocs avec coupleur de 1/4"
- Vitesse max. 3600 tours/mn
- Couple maximum 30 Nm
- Avec porte-embouts à changement rapide
- Rapport de transmission 1:1
- Connexion à l'outil par le biais de l'hexagone 1/4" D6.3



ISO 1173 E 6,3
ISO 1173 C 6,3

L mm	mm	mm	CHF		
137	1/4	1/4	93.00	1	008820090

882M1

Porte-embouts magnétique pour visseuses



ISO 1173 E 6,3

L mm	mm	mm	mm	CHF		
50	1/4	1/4	11	22.70	5	008820006

882M

Porte-embouts magnétique pour visseuses



ISO 1173 E 6,3

L mm	mm	mm	mm	CHF		
75	1/4	1/4	11	27.50	5	008820005

Beta

882MSR

Porte-embouts magnétique à bague de verrouillage rapide pour visseuses



ISO 1173 E 6,3

L mm	○	●	Ø mm	CHF	🔧	📄
50	1/4	1/4	11	24.60	5	008820205
75	1/4	1/4	11	28.50	5	008820207

882P

Rallonge porte-embouts magnétique



L mm	●	○	Ø mm	CHF	🔧	📄
80	1/4	1/4	10	20.10	5	008820080

892

Porte-douille pour visseuses



■	●	L mm	CHF	🔧	📄	
892/0	1/4	1/4	25	7.00	5	008920000
* 892/1	1/4	5.5	50	13.40	5	008920001
* 892/2	3/8	5.5	50	20.00	5	008920002
° 892/3	1/4	1/4	50	13.40	5	008920003
° 892/4	3/8	1/4	50	20.00	5	008920004
892/5	1/4	5/16	75	18.50	5	008920005
892/6	3/8	5/16	75	27.00	5	008920006
892/7	1/2	1/4	75	28.00	5	008920007

* ISO 1173 A 5,5
° ISO 1173 C 6,3



895

Douille porte-embouts pour 861, 862, 866



DIN 7427

	○	□	L mm	Ø mm	CHF	🔧	📄
895/1	1/4	1/4	25,4	12	16.10	5	008950000
895/3	1/4	3/8	29	16,8	19.20	5	008950001
895/4	5/16	3/8	29	16,8	19.20	5	008950002
895/5	1/4	1/2	38	22	19.20	5	008950005
895/6	5/16	1/2	38	22	19.20	5	008950003

897

Tournevis porte-embouts flexible



L mm	L1 mm	CHF	🔧	📄
280	154	36.50	2	008970010

897L

Tournevis porte-embouts flexible série longue



L mm	L1 mm	CHF	🔧	📄
500	380	42.00	2	008970015

CLIQUETS 9XX/55

Tête compacte



Fonctionne dans les petits espaces avec un angle de reprise de 5°, et équipé de 72 dents



Ne glisse et ne se relâche pas sous tension

- L'appui de la main sur la tête du cliquet ne provoque pas l'inversion et permet toujours le retour libre du cliquet
- Inversion du sens du cliquet pouvant s'effectuer à une main
- Caractéristiques mécaniques exceptionnelles



Charge de travail répartie, 17 dents en prise de contact permanente avec l'engrenage

900

Douille 6 pans



UNI/ISO 2725 DIN 3124

mm	Ø	L	Ø1	CHF	Hand	Icon
3,2	6,6	25	11,8	5.10	10	009000032
4	6,8	25	11,8	5.10	10	009000040
4,5	7,4	25	11,8	5.10	10	009000045
5	8,0	25	11,8	5.10	10	009000050
5,5	8,7	25	11,8	5.10	10	009000055
6	9,3	25	11,8	5.10	10	009000060
7	10,4	25	11,8	5.10	10	009000070
8	11,8	25	12,7	5.10	10	009000080
9	12,7	25	11,8	5.10	10	009000090
10	14,2	25	12,0	5.10	10	009000100
11	15,8	25	12,5	5.10	10	009000110
12	17,2	25	13,5	5.10	10	009000120
13	18,0	25	13,5	5.15	10	009000130
14	20,0	25	15,0	5.20	10	009000140



900/SB13
4-4,5-5-5,5-6-7-8-9
10-11-12-13-14 mm
CHF 88.50 1 009000150

900MC

Douille 6 pans, colorée

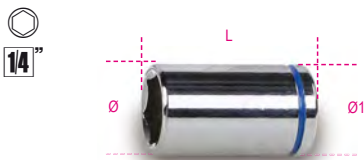

mm	L	Ø	Ø1	CHF	Hand	Icon
4	24,8	6,7	11,8	5.45	5	009002040
5	24,8	8,0	11,8	5.45	5	009002050
6	24,8	9,2	11,8	5.45	5	009002060
7	24,8	10,7	11,8	5.45	5	009002070
8	24,8	11,8	11,8	5.45	5	009002080
9	24,8	12,8	12,8	5.45	5	009002090
10	24,8	14,8	14,8	5.45	5	009002100
11	24,8	15,8	15,8	5.45	5	009002110
12	24,8	16,8	16,8	5.45	5	009002120
13	24,8	17,8	17,8	5.60	5	009002130
14	24,8	19,5	19,5	5.65	5	009002140

900MB

Douille 12 pans



UNI/ISO 2725 DIN 3124

mm	Ø	L	Ø1	CHF	Hand	Icon
4	6,7	22	11,2	9.85	5	009000160
5	7,7	25	11,2	9.85	5	009000161
5,5	8,3	25	11,2	9.85	5	009000162
6	9,0	25	11,2	9.85	5	009000163
7	10,2	25	11,2	9.85	5	009000164
8	11,3	25	12,0	9.85	5	009000165
9	13,0	25	12,0	9.85	5	009000166
10	14,3	25	12,9	9.85	5	009000167
11	16,0	25	14,3	9.85	5	009000168
12	17,4	25	16,0	9.85	5	009000169
13	18,0	25	16,4	10.90	5	009000170
14	19,3	25	17,9	11.50	5	009000171



900MB/SB12
4-5-5,5-6-7-8-9-10
11-12-13-14 mm
CHF 142.00 1 009000179

900L

Douille 6 pans série longue



UNI/ISO 2725 DIN 3124

mm	Ø	L	Ø1	CHF	Hand	Icon
4	6,5	50	12,0	11.90	5	009000181
4,5	7,0	50	12,0	11.90	5	009000182
5	7,5	50	12,0	11.90	5	009000183
5,5	8,5	50	12,0	11.90	5	009000184
6	9,5	50	12,0	11.90	5	009000185
7	10,5	50	12,0	11.90	5	009000186
8	12,0	50	12,0	11.90	5	009000187
9	13,0	50	13,0	11.90	5	009000188
10	14,0	50	14,0	12.30	5	009000189
11	16,0	50	16,0	12.30	5	009000190
12	17,5	50	17,5	12.30	5	009000191
13	17,5	50	17,5	12.30	5	009000192
14	20,0	50	20,0	12.30	5	009000193



900L/SB13
4-4,5-5-5,5-6-7-8-9-10-11-12-13-14 mm
CHF 178.50 1 009000203

900MB/L

Douille 12 pans série longue



UNI/ISO 2725 DIN 3124

mm	Ø	L	Ø1	CHF	Hand	Icon
5	8,0	50	12,0	18.20	3	009000211
6	9,3	50	12,0	18.20	3	009000212
7	10,9	50	12,0	18.20	3	009000213
8	11,6	50	12,0	18.20	3	009000214
9	13,0	50	12,0	18.20	3	009000215
10	14,3	50	12,8	19.40	3	009000216
11	16,0	50	14,2	19.40	3	009000217
12	17,4	50	15,5	19.40	3	009000218
13	18,0	50	16,2	19.60	3	009000219
14	19,0	50	17,1	20.00	3	009000220

900AS

Douille 6 pans



mm	Ø	L	Ø1	CHF	Hand	Icon
5/32	8,8	25	11,9	5.60	5	009000349
3/16	7,7	25	11,9	5.60	5	009000340
7/32	8,8	25	11,9	5.60	5	009000345
1/4	9,6	25	11,9	5.60	5	009000350
9/32	10,2	25	11,9	5.60	5	009000355
5/16	11,3	25	11,9	5.60	5	009000360
11/32	12,7	25	11,6	5.60	5	009000365
3/8	14,0	25	12,9	5.60	5	009000370
7/16	15,3	25	14,5	5.60	5	009000375
1/2	17,5	25	16,4	5.65	5	009000380
9/16	19,0	25	17,9	5.70	5	009000385



900AS/SB11
3/16-7/32-5/32-1/4-9/32-5/16-11/32-3/8-
7/16-1/2-9/16
CHF 81.00 1 009000389

900AS/MB

Douille 12 pans



SAE AS 954E

"	Ø	L	Ø1	CHF	Hand	Icon
3/16	7,7	22	10,9	10.10	2	009000390
7/32	8,5	22	10,9	10.10	2	009000391
1/4	9,4	22	10,9	10.10	2	009000392
9/32	10,2	22	10,9	10.10	2	009000393
5/16	11,3	22	11,7	10.10	2	009000394
11/32	12,5	22	12,0	10.10	2	009000395
3/8	13,7	22	12,9	10.70	2	009000396
7/16	15,6	22	14,3	10.70	2	009000397
1/2	17,2	22	16,4	11.90	2	009000398
9/16	18,8	24	17,9	12.00	2	009000399



900AS/L

Douille 6 pans série longue

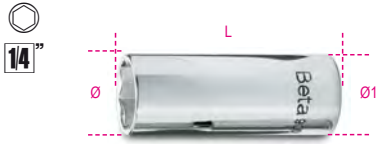

SAE AS 954E

"	Ø mm	L mm	Ø1 mm	CHF	🔧	📄
3/16	7,0	50	12,0	12.40	2	009000301
7/32	8,5	50	12,0	12.40	2	009000303
1/4	9,8	50	12,0	12.40	2	009000305
9/32	10,5	50	12,0	12.40	2	009000307
5/16	12,0	50	12,0	12.40	2	009000309
11/32	13,0	50	13,0	12.40	2	009000311
3/8	14,0	50	14,0	12.40	2	009000313
7/16	16,0	50	16,0	12.40	2	009000315
1/2	17,5	50	17,5	12.40	2	009000317
9/16	20,0	50	20,0	13.30	2	009000319

900AS/MBL

Douille 12 pans série longue



"	Ø mm	L mm	Ø1 mm	CHF	🔧	📄
5/32	6,8	50	12,0	19.20	2	009000325
3/16	8,0	50	12,0	19.20	2	009000326
7/32	8,5	50	12,0	19.20	2	009000327
1/4	9,8	50	12,0	19.20	2	009000328
9/32	10,9	50	12,0	19.20	2	009000329
5/16	11,6	50	12,0	19.20	2	009000330
11/32	13,0	50	12,0	19.20	2	009000331
3/8	14,3	50	12,8	20.60	2	009000332
7/16	16,0	50	14,2	20.60	2	009000333
1/2	18,0	50	16,2	20.60	2	009000334
9/16	19,0	50	17,1	20.60	2	009000335

900U

Douille multidents

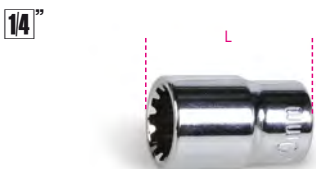

mm	"	🔧	📄	CHF	🔧	📄
4	5/32	E5	M5	5.35	5	009001702
4,5	3/16	E6		5.35	5	009001703
5	13/64		M6	5.35	5	009001704
5,5	7/32	E7		5.35	5	009001705
6	1/4	E8	M8	5.35	5	009001706
7	9/32			5.35	5	009001707
8	5/16	E10	M10	5.35	5	009001708
9	11/32			5.35	5	009001709
10	3/8	E12	M12	5.35	5	009001710
11	7/16	E14	M14	5.35	5	009001711
12	15/32	E16		5.35	5	009001712
13	1/2		M16	5.40	5	009001713
14	9/16	E18	M18	5.45	5	009001714

14"



900U/SB13	CHF	🔧	📄
4-4,5-5-5,5-6-7-8-9 10-11-12-13-14 mm	91.50	1	009001750

900FTX

Douille pour écrous Torx®

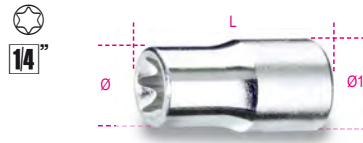

🔧	Ø mm	L mm	Ø1 mm	CHF	🔧	📄
E4	5,4	22	11,2	9.45	5	009000404
E5	6,7	22	11,2	9.45	5	009000405
E6	7,7	22	11,2	9.45	5	009000406
E7	8,3	22	11,2	9.45	5	009000407
E8	9,6	22	11,2	9.45	5	009000408
E10	11,3	22	12,0	9.45	5	009000410
E11	12,1	22	12,5	12.90	5	009000411
E12	12,9	23	12,9	12.90	5	009000412
E14	14,0	25	14,0	12.90	5	009000414

14"



900FTX/SB9	CHF	🔧	📄
E4-E5-E6-E7-E8 E10-E11-E12-E14	112.00	1	009000419

900LP

Douille tournevis pour vis à fente

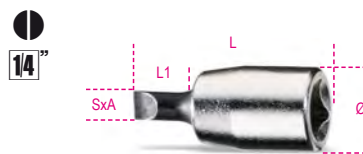

SxA mm	Ø mm	L mm	L1 mm	CHF	🔧	📄
0,8x4	12	28	9	11.40	5	009000605
1x5,5	12	28	9	11.40	5	009000610
1,2x6,5	12	28	9	11.40	5	009000615
1,2x8	13	28	8	11.40	5	009000620
1,6x10	14	28	8	11.40	5	009000625

900MC/LP

Douille tournevis pour vis à fente, colorée

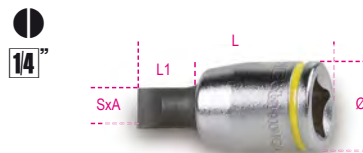

SxA mm	Ø mm	L mm	L1 mm	CHF	🔧	📄
0,8x4	12	28	9	17.90	3	009002605
1,2x6,5	12	28	9	17.90	3	009002615
1,2x8	13	28	8	17.90	3	009002620

900PH

Douille tournevis pour vis Phillips®(R)



PH	Ø mm	L mm	L1 mm	CHF	🔧	📄
1	12	28	12	12.40	5	009000701
2	12	28	12	12.40	5	009000702
3	12	28	12	12.40	5	009000703
4	13	28	11	12.40	5	009000704

14"



900PH/SB4	CHF	🔧	📄
PH1-PH2-PH3-PH4	59.50	1	009000708

900MC/PH

Douille tournevis pour vis Phillips®, colorée

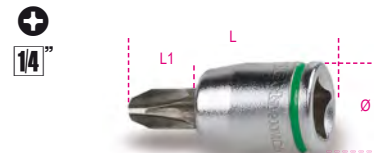

PH	Ø mm	L mm	L1 mm	CHF	🔧	📄
1	12	28	12	18.60	3	009002701
2	12	28	12	18.60	3	009002702
3	12	28	12	18.60	3	009002703

900PZ

Douille tournevis pour vis Pozidriv®-Supadriv®



PZ	Ø mm	L mm	CHF	🔧	📄
1	12	28	13.00	3	009000711
2	12	28	13.00	3	009000712
3	12	28	13.00	3	009000713

900ME

Douille tournevis pour vis 6 pans creux



mm	Ø mm	L mm	L1 mm	CHF	🔧	📄
2,5	12	25	4,5	10.70	5	009000502
3	12	25	5,0	10.70	5	009000503
4	12	25	5,6	10.70	5	009000504
5	12	25	6,3	10.70	5	009000505
6	12	25	7,6	10.70	5	009000506
7	13	25	7,2	10.70	5	009000507
8	13	25	8,0	10.70	5	009000508
10	13	25	8,7	13.30	5	009000510



900ME/SB8	CHF	🔧	📄
2,5-3-4-5-6-7-8-10 mm	103.50	1	009000518

900PE/AS

Douille tournevis pour vis 6 pans creux



"	Ø mm	L mm	CHF	🔧	📄
1/8	11,9	25	24.40	5	009000521
5/32	11,9	25	24.40	5	009000522
3/16	11,9	25	24.40	5	009000523
7/32	11,9	25	24.40	5	009000524
1/4	11,9	25	24.40	5	009000525
9/32	13,1	25	24.40	5	009000526
5/16	13,1	25	24.40	5	009000527

900PT

Douille tournevis pour vis en étoile à 5 pointes



PT	Ø mm	L mm	L1 mm	CHF	🔧	📄
PT10	12	28	12	22.80	5	009000750
PT15	12	28	12	22.80	5	009000755
PT20	12	28	12	22.80	5	009000760
PT25	12	28	12	22.80	5	009000765
PT27	12	28	12	22.80	5	009000767
PT30	12	28	12	22.80	5	009000770

900TX

Douille tournevis pour vis Torx®



T	Ø mm	L mm	L1 mm	CHF	🔧	📄
T6	12	28	12	16.60	5	009000717
T7	12	28	12	16.60	5	009000718
T8	12	28	12	16.70	5	009000719
T9	12	28	12	16.70	5	009000720
T10	12	28	12	16.70	5	009000721
T15	12	28	12	16.70	5	009000722
T20	12	28	12	16.70	5	009000723
T25	12	28	12	16.70	5	009000724
T27	12	28	12	16.70	5	009000725
T30	12	28	12	16.70	5	009000726
T40	12	28	12	16.70	5	009000727



900TX/SB8	CHF	🔧	📄
T9-T10-T15-T20 T25-T27-T30-T40	149.50	1	009000730

900MC/TX

Douille tournevis pour vis Torx®, colorée



T	Ø mm	L mm	L1 mm	CHF	🔧	📄
T10	12	28	12	19.20	3	009002721
T15	12	28	12	19.20	3	009002722
T20	12	28	12	19.20	3	009002723
T25	12	28	12	19.20	3	009002724
T27	12	28	12	19.20	3	009002725
T30	12	28	12	19.20	3	009002726
T40	12	28	12	19.20	3	009002727

900/16

Augmentateur carré femelle 1/4" et mâle 3/8"



UNI/ISO 3316 DIN 3123

L mm	Ø mm	CHF	🔧	📄
28	13,0	8.75	5	009000814

900/...

Rallonge carrés mâle et femelle 1/4"

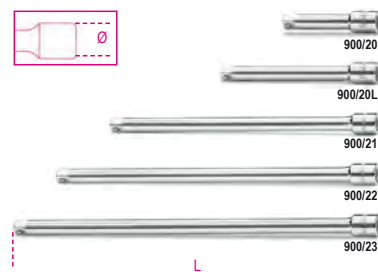

UNI/ISO 3316 DIN 3123

900/...	L mm	Ø mm	CHF	🔧	📄
900/20	50	11,5	11.10	5	009000818
900/20L	100	11,5	11.40	5	009000819
900/21	150	11,5	11.90	5	009000822
900/22	250	11,5	17.50	5	009000823
900/23	350	11,5	21.00	5	009000824

900AN

Rallonge angulaire carrés mâle et femelle 1/4"

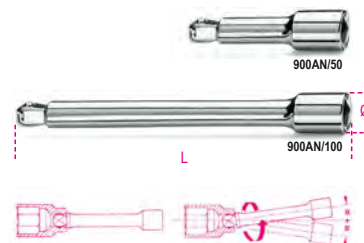

900AN/...	L mm	Ø mm	CHF	🔧	📄
900AN/50	50	11,5	12.00	3	009000825
900AN/100	100	11,5	13.30	3	009000826

900FL

Rallonge flexible carrés mâle et femelle 1/4"

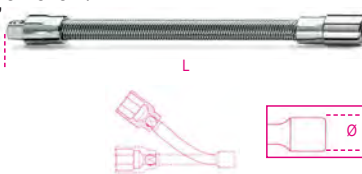

L mm	Ø mm	CHF	🔧	📄
150	12	17.70	3	009000828

900/25

Cardan carrés mâle et femelle 1/4"



UNI/ISO 3316 DIN 3123

L mm	Ø mm	CHF	🔧	📄
41	12,5	21.60	5	009000830

900BG/30C

Poignée emmanchée carré mâle 1/4"



UNI/ISO 3315 DIN 3122

L mm	L1 mm	CHF		
128	20	10.60	5	009000833

900BG/30

Poignée emmanchée carré mâle 1/4"



UNI/ISO 3315 DIN 3122

L mm	L1 mm	CHF		
176	68	11.10	5	009000834

900/32

Poignée emmanchée flexible carré mâle 1/4"



L mm	L1 mm	CHF		
280	154	25.50	2	009000839

900/35A

Poignée articulée carré mâle 1/4"



UNI/ISO 3315 DIN 3122

L mm	L1 mm	CHF		
148	84	36.50	5	009000840

900M/35

Poignée articulée carré mâle 1/4" avec manche métallique



UNI/ISO 3315
DIN 3122

L mm	CHF			
130	46.50	3	009000845	



900/40

Poignée à béquille à cardan carré mâle 1/4"



L mm	L1 mm	CHF		
390	145	49.00	3	009000843

900/42

Poignée coulissante carré mâle 1/4"

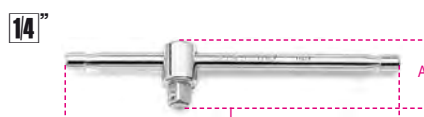

UNI/ISO 3315 DIN 3122

L mm	A mm	CHF		
115	22	12.20	5	009000854

900T/44

Poignée emmanchée coudée carré mâle 1/4"



L mm	L1 mm	CHF		
238	105	18.40	2	009000860

900/55

Cliquet réversible carré mâle 1/4" à 48 dents



UNI/ISO 3315 DIN 3122

L mm	Ø mm	A mm	CHF	
125	25	29	58.00	5 009000870

900/55Z



Le cliquet 900/55Z a été développé par le service technique de Beta sur la base d'un nouveau mécanisme à 72 dents, dont 15 dents sont en contact permanent avec l'engrenage.

Ce développement permet une meilleure répartition de la charge de travail et réduit donc l'usure des pièces entraînant un rallongement important de sa durée de vie.



De plus avec sa tête extrêmement compacte et ses 72 dents assurant un angle de reprise ne dépassant pas 5°, lui permet un accès rapide dans les espaces réduits.

La poignée ergonomique bi-matière de Beta permet à la fois une utilisation rapide du cliquet avec une force accrue.

900/55Z

Cliquet réversible carré mâle 1/4" mécanisme à 72 dents



L mm	Ø mm	A mm	CHF	
126	25	23	58.00	3 009000882

900M/55

Cliquet réversible carré mâle 1/4"
manche métallique



UNI/ISO 3315 DIN 3122			CHF	3	009000905
L	Ø	A			
mm	mm	mm	75.00		
110	22	18			

Voir le tableau après la ref. 928/C8
pour les pièces détachées du mécanisme
de la tête de la clé dynamométrique

900/58

Cliquet réversible
avec manche rotatif et carré mâle 1/4"
mécanisme à 52 dents

- Système d'utilisation avec manche rotatif
- Touche de déverrouillage de la douille
- Système d'inversion à douille sur la tête du cliquet
- Manche bi-matières



L	Ø	A	CHF	2	009000884
mm	mm	mm			
126	28	28,5	88.50		

900/C39N

Coffret compact composé de 11 douilles 6 pans,
21 embouts et 7 accessoires



CHF			1	009000947
261.00				

861LP	0,6x4,5 - 1,2x6,5 - 1,2x8 mm
861PH	PH1-PH2-PH3
861PZ	PZ1-PZ2-PZ3
861PE	2,5-3-4-5-6 mm
861RTX	T10-T15-T20-T25-T27-T30-T40
900	5-5,5-6-7-8-9-10-11-12-13-14 mm
900/20	50 mm
900/20L	100 mm
900/25	
900BG/30C	128 mm
892/0	
895/1	
900/55Z	126 mm

900/C39U

Coffret compact composé de 11 douilles multi
empreintes, 21 embouts et 7 accessoires



CHF			1	009001947
264.00				

861LP	0,6x4,5 - 1,2x6,5 - 1,2x8 mm
861PH	PH1-PH2-PH3
861PZ	PZ1-PZ2-PZ3
861PE	2,5-3-4-5-6 mm
861RTX	T10-T15-T20-T25-T27-T30-T40
900U	○ 5-5,5-6-7-8-9-10-11-12-13-14 mm * 3/16-13/64-7/32-1/4-9/32-5/16- 11/32-3/8-7/16-15/32-1/2-9/16 ◎ E6-E7-E8-E10-E12-E14-E16-E18 ○ M6-M8-M10-M12-M14-M16-M18
900/20	50 mm
900/20L	100 mm
900/25	
900BG/30C	128 mm
892/0	
895/1	
900/55Z	126 mm

900/C11

11 douilles 6 pans, 20 embouts
pour visseuses et 8 accessoires



CHF			1	009000971
285.00				

861LP	0,5x3 - 0,8x5,5 1x5,5 - 1,2x6,5 mm
861PE	3 - 4 - 5 - 6 - 8 mm
861PH	0 - 1 - 2 - 3
861TX	T8 - T10 - T15 - T20 T25 - T30 - T40
895/1	
900	5 - 5,5 - 6 - 7 - 8 - 9 - 10 11 - 12 - 13 - 14 mm
900/16	□ 1/4 - ■ 3/8
900/20	50 mm
900/21	150 mm
900/25	
900BG/30	176 mm
900/42	
900/55	

270x120x45 mm - 1,2 kg

CHF			1	098990132
16.40				
9899 900C11 Plateau thermoformé vide				

900/C11Z

11 douilles 6 pans,
20 embouts pour visseuses et 8 accessoires



CHF			1	009000984
285.00				

861LP	0,5x3 - 0,8x5,5 - 1x5,5 - 1,2x6,5 mm
861PE	3 - 4 - 5 - 6 - 8 mm
861PH	0 - 1 - 2 - 3
861TX	T8 - T10 - T15 - T20 T25 - T30 - T40
895/1	
900	5 - 5,5 - 6 - 7 - 8 - 9 - 10 11 - 12 - 13 - 14 mm
900/16	□ 1/4 - ■ 3/8
900/20	50 mm
900/21	150 mm
900/25	
900BG/30	176 mm
900/42	
900/55Z	

350x150x50 mm - 1,2 kg

CHF			1	098990132
16.40				
9899 900C11 Plateau thermoformé vide				

900/C12MR

Coffret métallique avec plateau en mousse
compacte comprenant 1 cliquet avec 12
douilles 6 pans, 20 embouts pour visseuses et
7 accessoires



CHF			1	009000962
319.00				

900	4-5-5,5-6-7-8-9-10-11-12-13-14 mm
900/20	50 mm
900/21	150 mm
900/25	
900/42	115 mm
900BG/30	128 mm
900/58	
895/1	
861TX	T8-T10-T15-T20-T25-T30-T40
861PH	PH0-PH1-PH2-PH3
861LP	0,5-0,8-1-1,2 mm
861PE	3-4-5-6-8 mm

350x150x50 mm 1,3 kg

900/C12MZ

12 douilles 6 pans, 20 embouts pour visseuses et 7 accessoires en plateau en mousse compacte

1/4"

1/4"



900/C12MZ CHF 288.00 1 009000983

- 900 4-5-5,5-6-7-8-9-10-11-12-13-14 mm
- 900/20 50 mm
- 900/21 150 mm
- 900/25
- 900/42 115 mm
- 900BG/30 176 mm
- 900/55Z
- 895/1
- 861TX T8-T10-T15-T20-T25-T30-T40
- 861PH PH0-PH1-PH2-PH3
- 861LP 0,5x3 - 0,8x5,5 - 1x5,5 - 1,2x6,5 mm
- 861PE 3-4-5-6-8 mm

350x150x50 mm - 1,2 kg

900/C13-5

13 douilles 6 pans et 5 accessoires

1/4"



900/C13-5 CHF 230.50 1 009000953

- 900 4-4,5-5-5,5-6-7-8-9-10-11-12-13-14 mm
- 900/21 150 mm
- 900/25
- 900BG/30
- 900/42
- 900/55

270x120x45 mm - 1 kg

9899 900/C13-5 CHF 16.40 1 098990131

Plateau thermoformé vide

900/C13-8

13 douilles 6 pans et 8 accessoires

1/4"



900/C13-8 CHF 280.00 1 009000954

- 900 4-4,5-5-5,5-6-7-8-9-10-11-12-13-14 mm
- 900/16 □ 1/4 - ■ 3/8
- 900/20 50 mm
- 900/21 150 mm
- 900/25
- 900BG/30
- 900/35A
- 900/42
- 900/55

270x120x45 mm - 1,1 kg

900MB/C19

11 douilles 12 pans et 8 accessoires

1/4"



900MB/C19 CHF 325.00 1 009000977

- 900MB 5-5,5-6-7-8-9-10-11-12-13-14 mm
- 900/16 □ 1/4 - ■ 3/8
- 900/20 50 mm
- 900/21 150 mm
- 900/25
- 900BG/30
- 900/35A
- 900/42
- 900/55

270x120x45 mm - 1,1 kg

900/C24

13 douilles 6 pans, 11 douilles tournevis et 6 accessoires

1/4"



900/C24 CHF 360.00 1 009000956

- 900 4-4,5-5-5,5-6-7-8-9-10-11-12-13-14 mm
- 900LP 0,8x4 - 1,2x6,5 - 1,2x8 mm
- 900PH PH1 - PH2 - PH3
- 900ME 3-4-5-6-8 mm
- 900/20 50 mm
- 900/21 150 mm
- 900/25
- 900BG/30
- 900/42
- 900/55

270x120x45 mm - 1,1 kg

900MB/C28

11 douilles 12 pans, 11 douilles tournevis et 6 accessoires

1/4"



900MB/C28 CHF 405.00 1 009000979

- 900MB 5-5,5-6-7-8-9-10-11-12-13-14 mm
- 900LP 0,8x4 - 1,2x6,5 - 1,2x8 mm
- 900PH PH1 - PH2 - PH3
- 900ME 3-4-5-6-8 mm
- 900/20 50 mm
- 900/21 150 mm
- 900/25
- 900BG/30
- 900/42
- 900/55

270x120x45 mm - 1,1 kg



900MC/C24

11 douilles 6 pans,
13 douilles tournevis colorées et 6 accessoires

1/4"



900MC/C24 CHF 474.00 1 009002960

	900MC	4 - 5 - 6 - 7 - 8 - 9 10 - 11 - 12 - 13 - 14 mm
	900MC/PH	PH1 - PH2 - PH3
	900MC/TX	T10 - T15 - T20 - T25 - T27 - T30 - T40
	900MC/LP	0,8x4 - 1,2x6,5 - 1,2x8 mm
	900/20	50 mm
	900/21	150 mm
	900/25	
	900BG/30	
	900/42	
	900/55	

270x120x45 mm - 1 kg

900MC/C32

11 douilles colorées, 20 embouts colorés pour visseuses et 7 accessoires

1/4"



900MC/C32 CHF 298.00 1 009002963

	900MC	4 - 5 - 6 - 7 - 8 - 9 - 10 - 11 - 12 - 13 - 14 mm
	860LP	0,5x3 - 0,8x5,5 - 1,0x5,5 - 1,2x6,5 mm
	860PH	0 - 1 - 2 - 3
	860PE	3 - 4 - 5 - 6 - 8 mm
	860TX	T8 - T10 - T15 - T20 - T25 - T30 - T40
	895/1	
	900/20	
	900/21	
	900/25	
	900BG/30	
	900/42	
	900/55	

270x120x45 mm - 1,2 kg

900U/C12M

Coffret 1/4 composé de 12 douilles multi empreintes, 20 embouts et 7 accessoires, dans un plateau en mousse.

1/4"

1/4"



900U/C12M CHF 291.00 1 009001792

	900U	○ 4-5-5-6-7-8-9-10-11-12-13-14 mm * 5/32-3/16-13/64-7/32-1/4-9/32-5/16 11/32-3/8-7/16-15/32-1/2-9/16 ○ E5-E6-E7-E8-E10-E12-E14-E16-E18 ○ M5-M6-M8-M10-M12-M14-M16-M18
	900/20	50 mm
	900/21	150 mm
	900/25	
	900/42	115 mm
	900BG/30	176 mm
	900/55	125 mm
	895/1	○ 1/4 - □ 1/4
	861LP	0,5x3 - 0,8x5,5 - 1,0x5,5 - 1,2x6,5 mm
	861PE	3-4-5-6-8 mm
	861PH	PH0-PH1-PH2-PH3
	861TX	T8-T10-T15-T20-T25-T30-T40

350x150x50 mm - 1,2 kg

900AS/C10 - /MB-C17

10 douilles et 7 accessoires

1/4"



900AS/C10 CHF 262.00 1 009000961

	900AS	3/16 - 7/32 - 1/4 - 9/32 - 5/16 11/32 - 3/8 - 7/16 - 1/2 - 9/16
	900/20	50 mm
	900/21	150 mm
	900/25	
	900BG/30	
	900/35A	
	900/42	
	900/55	

270x120x45 mm - 1,1 kg

900AS/MB-C17 CHF 311.00 1 009000981

	900AS/MB	3/16 - 7/32 - 1/4 - 9/32 - 5/16 11/32 - 3/8 - 7/16 - 1/2 - 9/16
	900/20	50 mm
	900/21	150 mm
	900/25	
	900BG/30	
	900/35A	
	900/42	
	900/55	

270x120x45 mm - 1,1 kg

900AS/C17-MBM

10 douilles 12 pans
et 7 accessoires
pour maintenance aéronautique

1/4"



900AS/C17-MBM CHF 337.00 1 009000982

	900AS/MB	3/16 - 7/32 - 1/4 - 9/32 - 5/16 11/32 - 3/8 - 7/16 - 1/2 - 9/16
	900/20	50 mm
	900/21	150 mm
	900/25	
	900BG/30	
	900M/35	
	900/42	
	900M/55	

270x120x45 mm - 1,2 kg



900/C11HR

Coffret métallique avec plateau thermoformé rigide comprenant 1 cliquet avec 11 douilles 6 pans, 20 embouts pour visseuses et 7 accessoires

• cliquet avec branche rotative

1/4"

14"



900/C11HR CHF 315.00 1 009000980

- 861LP 0,5x3-0,8x5,5-1x5,5-1,2x6,5 mm
 - 861PH PH0-PH1-PH2-PH3
 - 861PE 3-4-5-6-8 mm
 - 861TX T8-T10-T15-T20-T25-T30-T40
 - 895/1
 - 900 5-5,5-6-7-8-9-10-11-12-13-14 mm
 - 900/16 □ 1/4 - ■ 3/8
 - 900/20 50 mm
 - 900/21 150 mm
 - 900/25
 - 900/42
 - 900BG/30
 - 900/58
- ≡ 350x150x50 mm - 1,3 kg

902R/C6

Coffret de 6 augmentateurs / réducteurs pour douilles



902R/C6 CHF 118.50 1 009020814

- 900/16 □ 1/4 - ■ 3/8
 - 910/15 □ 3/8 - ■ 1/4
 - 910/16 □ 3/8 - ■ 1/2
 - 920/15 □ 1/2 - ■ 3/8
 - 920/16 □ 1/2 - ■ 3/4
 - 928/15 □ 3/4 - ■ 1/2
- ≡ 170x100x35 mm - 600 g

902A/C22

Coffret métallique comprenant 7 douilles 6 pans, 28 embouts, 1 porte-embouts à poignée en T avec cliquet réversible et 1 accessoire

14"

12"



902A/C22 CHF 454.00 1 009020807

- 900 5-5,5-6-7-8-9-10-11-12-13 mm
 - 900/20 50 mm
 - 900/25
 - 14" 900/55
 - 920A 10-13-14-15-17-18-19-22-24-27-30-32 mm
 - 920/21 125 mm
 - 920/25
 - 12" 920/55
- ≡ 420x185x60 mm - 3,5 kg

9899 902A/C22 CHF 16.40 1 098990133
Plateau thermoformé vide

910A

Douille 6 pans

3/8"

38"



UNI/ISO 2725 DIN 3124

mm	Ø mm	L mm	Ø1 mm	CHF		
6	9,5	28	16,7	7.95	5	009100006
7	10,7	28	16,7	7.95	5	009100007
8	12,1	28	16,7	7.95	5	009100008
9	13,2	28	16,7	7.95	5	009100009
10	14,6	29	16,7	7.95	5	009100010
11	15,8	29	16,7	7.95	5	009100011
12	17,2	30	17,7	8.25	5	009100012
13	18,4	31	17,0	8.25	5	009100013
14	19,7	32	17,5	8.25	5	009100014
15	20,9	32	18,0	8.25	5	009100015
16	22,2	33	18,5	9.25	5	009100016
17	23,2	33	19,0	9.25	5	009100017
18	24,7	34	20,0	9.25	5	009100018
19	25,8	35	21,0	9.25	5	009100019
20	27,2	35	22,0	9.85	5	009100020
21	28,2	36	23,0	9.85	5	009100021
22	29,7	37	24,0	10.20	5	009100022

3/8"

38"



910A/SB17 CHF 176.00 1 009100030
6-7-8-9-10-11-12
13-14-15-16-17
18-19-20-21-22 mm

910B

Douille 12 pans

3/8"

38"



UNI/ISO 2725 DIN 3124

mm	Ø mm	L mm	Ø1 mm	CHF		
6	9,5	28	16,7	7.95	5	009100106
7	10,7	28	16,7	7.95	5	009100107
8	12,1	28	16,7	7.95	5	009100108
9	13,2	28	16,7	7.95	5	009100109
10	14,6	29	16,7	7.95	5	009100110
11	15,8	29	16,7	7.95	5	009100111
12	17,2	30	17,7	8.25	5	009100112
13	18,4	31	17,0	8.25	5	009100113
14	19,7	32	17,5	8.25	5	009100114
15	20,9	32	18,0	8.25	5	009100115
16	22,2	33	18,5	9.25	5	009100116
17	23,2	33	19,0	9.25	5	009100117
18	24,7	34	20,0	9.25	5	009100118
19	25,8	35	21,0	9.25	5	009100119
20	27,2	35	22,0	9.85	5	009100120
21	28,2	36	23,0	9.85	5	009100121
22	29,7	37	24,0	10.20	5	009100122

3/8"

38"



910B/SB17 CHF 176.00 1 009100130
6-7-8-9-10-11-12
13-14-15-16-17
18-19-20-21-22 mm

910AL

Douille 6 pans série longue

3/8"

38"



UNI/ISO 2725 DIN 3124

mm	Ø mm	L mm	Ø1 mm	CHF		
8	12,0	55	17	17.00	3	009100158
9	13,0	55	17	17.00	3	009100159
10	14,5	55	17	17.00	3	009100160
11	16,0	55	17	17.00	3	009100161
12	17,0	55	17	17.00	3	009100162
13	18,0	55	17	18.60	3	009100163
14	20,0	55	18	18.60	3	009100164
15	21,0	55	20	18.60	3	009100165
16	22,0	55	20	18.60	3	009100166
17	23,5	55	22	18.60	3	009100167
18	24,5	55	23	20.30	2	009100168
19	25,0	55	24	20.30	2	009100169
21	27,0	65	26	21.80	2	009100171
22	29,0	65	28	21.80	2	009100172

910AL/SB14 CHF 286.00 1 009100174
8-9-10-11-12-13-14
15-16-17-18-19-21-22 mm

910BL

Douille 12 pans série longue



UNI/ISO 2725 DIN 3124

mm	Ø	L	Ø1	CHF	Icon
8	12,0	55	17	17.00	3 009100308
9	13,0	55	17	17.00	3 009100309
10	14,5	55	17	17.00	3 009100310
11	16,0	55	17	17.00	3 009100311
12	17,0	55	17	17.00	3 009100312
13	18,0	55	17	18.60	3 009100313
14	20,0	55	18	18.60	3 009100314
15	21,0	55	20	18.60	3 009100315
16	22,0	55	20	18.60	3 009100316
17	23,5	55	22	18.60	3 009100317
18	24,5	55	23	20.30	2 009100318
19	25,0	55	24	20.30	2 009100319
21	27,0	65	26	21.80	2 009100321
22	29,0	65	28	21.80	2 009100322



		CHF	Icon
910BL/SB14	8-9-10-11-12-13 14-15-16-17-18 19-21-22 mm	286.00	1 009100340

910B/SN

Douille 12 pans à cardan



mm	Ø	L	Ø1	CHF	Icon
10	14,5	48,5	19	44.00	2 009100230
11	15,8	49,5	19	44.00	2 009100231
12	17,0	50,0	19	44.00	2 009100232
13	18,3	51,0	19	44.00	2 009100233
14	19,5	51,0	19	49.00	2 009100234
15	20,8	53,5	19	49.00	2 009100235
16	22,0	53,5	19	49.00	2 009100236
17	23,3	54,5	19	49.00	2 009100237
18	24,5	54,5	19	49.00	2 009100238
19	25,8	56,5	19	49.00	2 009100239

910A/AS

Douille 6 pans



"	Ø	L	Ø1	CHF	Icon
1/4	10,3	26	17,3	9.50	5 009100276
5/16	11,9	26	17,3	9.50	5 009100278
11/32	13,3	26	17,3	9.50	5 009100279

"	Ø	L	Ø1	CHF	Icon
3/8	13,9	26	17,3	9.50	5 009100280
7/16	15,8	26	17,3	9.50	5 009100281
1/2	17,9	26	17,3	9.75	5 009100283
9/16	19,5	27	18,5	9.75	5 009100284
19/32	20,6	27	19,5	9.75	5 009100285
5/8	21,9	28	20,0	10.50	5 009100286
11/16	24,6	30	22,5	10.50	5 009100287
3/4	25,9	30	23,5	10.50	5 009100289
13/16	27,9	32	26,0	11.90	5 009100291
7/8	29,6	32	26,5	12.30	5 009100292



		CHF	Icon
910A-AS/SB13	1/4-5/16-11/32-3/8-7/16 1/2-9/16-19/32-5/8-11/16 3/4-13/16-7/8	155.50	1 009100295

910AS

Douille 12 pans



"	Ø	L	Ø1	CHF	Icon
1/4	9,5	28	16,7	9.50	5 009100201
5/16	12,1	28	16,7	9.50	5 009100202
11/32	13,2	28	16,7	9.50	5 009100203
3/8	14,6	29	16,7	9.50	5 009100204
7/16	15,8	29	16,7	9.50	5 009100205
1/2	18,4	31	17,0	9.75	5 009100206
9/16	19,7	32	17,5	9.75	5 009100207
19/32	20,9	32	18,0	9.75	5 009100208
5/8	22,2	33	18,5	10.50	5 009100209
11/16	24,7	34	20,0	10.50	5 009100210
3/4	25,8	35	21,0	10.50	5 009100211
13/16	28,2	36	23,0	11.90	5 009100212
7/8	29,7	37	24,0	12.30	5 009100213



		CHF	Icon
910AS/SB13	1/4-5/16-11/32-3/8-7/16 1/2-9/16-19/32-5/8-11/16 3/4-13/16-7/8	155.50	1 009100215

910AS/L

Douille 12 pans série longue

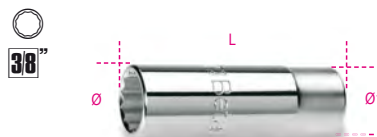

"	Ø	L	Ø1	CHF	Icon
1/4	10	55	17	21.50	3 009100350
5/16	12	55	17	21.50	3 009100351
3/8	14	55	17	21.50	3 009100352
7/16	16	55	17	21.50	3 009100353
1/2	18	55	17	23.80	3 009100354
9/16	20	55	18	23.80	3 009100355

"	Ø	L	Ø1	CHF	Icon
19/32	21	55	20	24.40	3 009100356
5/8	22	55	20	24.40	3 009100357
11/16	23	55	22	24.40	3 009100359
3/4	25	55	24	26.00	3 009100360
13/16	27	65	26	30.00	3 009100362
7/8	29	65	28	30.00	3 009100363



		CHF	Icon
910ASL/SB12	1/4-5/16-3/8-7/16 1/2-9/16-19/32-5/8-11/16 3/4-13/16-7/8	315.00	1 009100365

910AS/SN

Douille 12 pans à cardan



* SAE AS 954E

"	Ø	L	Ø1	CHF	Icon
* 3/8	14,0	48,0	19	48.50	2 009100260
* 7/16	15,8	51,0	19	48.50	2 009100261
* 1/2	18,3	51,0	19	48.50	2 009100262
* 9/16	19,5	51,0	19	49.00	2 009100263
* 5/8	22,0	53,5	19	49.00	2 009100264
11/16	24,5	54,5	19	52.00	2 009100265
3/4	25,8	56,5	19	52.00	2 009100266

910FTX

Douille pour écrous Torx®



Ø	L	Ø1	CHF	Icon	
E4	6,2	26	17,3	11.40	5 009100404
E5	7,0	26	17,3	11.40	5 009100405
E6	8,3	26	17,3	11.40	5 009100406
E7	8,9	26	17,3	11.40	5 009100407
E8	9,9	26	17,3	11.40	5 009100408
E10	12,0	26	17,3	11.40	5 009100410
E11	13,3	26	17,3	11.40	5 009100411
E12	14,5	26	17,3	11.40	5 009100412
E14	15,8	26	17,3	11.40	5 009100414
E16	18,0	26	17,3	11.40	5 009100416
E18	19,5	26	18,5	12.50	3 009100418
E20	21,9	26	20,0	12.50	3 009100420



		CHF	Icon
910FTX/SB9	E4-E5-E6-E7-E8 E10-E12-14-E16	119.50	1 009100430

910FTX/L

Douille pour écrous à empreinte Torx®, série longue



	Ø mm	L mm	Ø1 mm	CHF		
E4	6,2	55	17,3	25.50	3	009100440
E5	7,0	55	17,3	25.50	3	009100441
E6	8,3	55	17,3	25.50	3	009100442
E7	8,9	55	17,3	25.50	3	009100443
E8	9,9	55	17,3	25.50	3	009100444
E10	12,0	55	17,3	25.50	3	009100445



	CHF		
910FTX-L/SB6 E4-E5-E6 E7-E8-E10	166.50	1	009100449

910FTX/XL

Douille pour vis Torx®, série extra longue



	Ø mm	L mm	Ø1 mm	CHF		
E6	8,0	200	18	23.10	2	009100766
E7	8,0	200	18	23.10	2	009100767
E8	10,0	200	18	23.10	2	009100768
E10	14,0	200	18	23.10	2	009100770
E11	14,0	200	18	23.10	2	009100771
E12	14,0	200	18	23.10	2	009100772
E14	17,0	200	18	25.00	2	009100774
E16	18,6	200	18	25.00	2	009100776
E18	21,5	200	18	26.50	2	009100778
E20	21,5	200	18	26.50	2	009100780

910FTX-XL/C10

Jeu de 10 douilles pour écrous à empreinte Torx®, série longue, en coffret plastique



	CHF		
910FTX-XL/C10 E6-E7-E8-E10-E11- E12-E14-E16-E18-E20	242.00	1	009100976

255x195x62 mm - 2,3 kg

910LP

Douille tournevis pour vis à fente

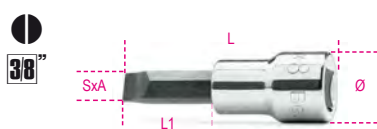

SxA mm	Ø mm	L mm	L1 mm	CHF		
1x5,5	18,5	54	24	20.10	2	009100452
1,2x6,5	18,5	54	24	20.10	2	009100453
1,2x8	18,5	54	24	20.10	2	009100454
1,6x9	18,5	54	24	20.10	2	009100456

910PH

Douille tournevis pour vis Phillips®



PH	Ø mm	L mm	L1 mm	CHF		
1	18,5	48	18	18.70	2	009100471
2	18,5	48	18	18.70	2	009100472
3	18,5	48	18	18.70	2	009100473
4	18,5	48	18	18.70	2	009100474



	CHF		
910PH/SB4 PH1-PH2-PH3-PH4	85.00	1	009100478

910PE

Douille tournevis pour vis 6 pans creux



DIN 7422

mm	Ø mm	L mm	L1 mm	CHF		
3	18,5	50	20	16.40	5	009100490
4	18,5	50	20	16.40	5	009100492
5	18,5	50	20	16.40	5	009100494
6	18,5	50	20	16.40	5	009100496
7	18,5	50	20	16.40	5	009100497
8	18,5	50	20	16.40	5	009100498
9	18,5	50	20	16.40	5	009100499
10	18,5	50	20	16.40	5	009100500



	CHF		
910PE/SB7 3-4-5-6-7-8-10 mm	129.00	1	009100503

910BP

Douille tournevis à tête sphérique pour vis 6 pans creux



mm	L mm	L1 mm	CHF		
4L	92	62	19.50	3	009100584
5L	92	62	19.50	3	009100585
6L	92	62	19.50	3	009100586
7L	92	62	19.50	3	009100587
8L	92	62	19.50	3	009100588
10L	132	102	21.10	3	009100590



	CHF		
910BP/SB6L 4L-5L-6L-7L-8L-10L mm	131.50	1	009100596

910ME

Douille tournevis pour vis 6 pans creux



mm	Ø mm	L mm	L1 mm	CHF		
4	18	62	15	19.60	5	009100504
5	18	62	15	19.60	5	009100505
6	18	62	15	19.60	5	009100506
7	18	62	15	20.00	5	009100507
8	19	62	15	20.00	5	009100508
10	20	62	15	20.00	5	009100510
12	20	62	15	20.00	5	009100512



	CHF		
910ME/SB5 4-5-6-8-10 mm	110.50	1	009100515

910PE/AS

Douille tournevis pour vis 6 pans creux



"	Ø mm	L mm	L1 mm	CHF		
1/8	18,5	50	20	28.00	2	009100531
5/32	18,5	50	20	28.00	2	009100532
3/16	18,5	50	20	28.00	2	009100533
7/32	18,5	50	20	28.00	2	009100534
1/4	18,5	50	20	28.00	2	009100535
5/16	18,5	50	20	28.00	2	009100536
3/8	18,5	50	20	31.00	2	009100537

910PT

Douille tournevis pour vis en étoile à 5 pointes

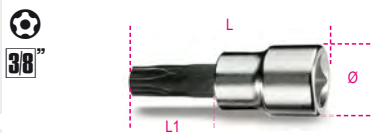

	Ø mm	L mm	L1 mm	CHF		
PT40	20	50	20	26.00	3	009100540
PT45	20	50	20	26.50	3	009100545
PT50	20	50	20	31.50	3	009100550



	CHF		
910PT/SB8	214.00	1	009100558
PT10-PT15-PT20-PT25			
PT30-PT40-PT45-PT50			

910TX

Douille tournevis pour vis Torx®



	Ø mm	L mm	L1 mm	CHF		
T15	18,5	50	20	21.50	5	009100519
T20	18,5	50	20	21.50	5	009100520
T25	18,5	50	20	21.50	5	009100521
T27	18,5	50	20	21.50	5	009100522
T30	18,5	50	20	21.50	5	009100523
T40	18,5	50	20	21.50	5	009100524
T45	18,5	50	20	21.50	3	009100525
T50	18,5	50	20	21.50	3	009100526



	CHF		
910TX/SB6	141.50	1	009100530
T15-T20-T25			
T27-T30-T40			

910XZN

Douille tournevis pour vis XZN®



	L mm	CHF		
M4	50	23.10	3	009100559
M5	50	23.10	3	009100560
M6	50	23.10	3	009100561
M8	50	23.10	3	009100563
M10	50	24.40	3	009100565

910CF

Clé à fourche à patte de coq avec carré femelle 3/8"



	A mm	L mm	CHF		
10	21,3	32,3	13.90	2	009100135
11	23,1	34,3	13.90	2	009100136
12	25,5	36,2	15.60	2	009100137
13	26,9	37,4	15.60	2	009100138
14	30,2	40,0	16.60	2	009100139
15	33,3	41,3	17.40	2	009100140
16	33,3	41,3	18.90	2	009100141
17	38,1	46,5	21.80	2	009100142
18	38,1	46,5	21.80	2	009100143
19	39,6	48,0	23.80	2	009100144



	CHF		
910CF/SB10	198.50	1	009100147
10-11-12-13-14-15			
16-17-18-19 mm			

910/15

Réducteur carré femelle 3/8" et mâle 1/4"



L mm	Ø mm	CHF		
30	17,0	12.00	5	009100810
			3/8	1/4



Toujours appliquer la force de serrage régulièrement et progressivement afin d'éviter la rupture et de se protéger contre un possible accident.

910/16

Augmentateur carré femelle 3/8" et mâle 1/2"



L mm	Ø mm	CHF		
32	18,0	12.50	5	009100814
			3/8	1/2



910/20 - 910/21 - 910/22

Rallonge carrés mâle et femelle 3/8"

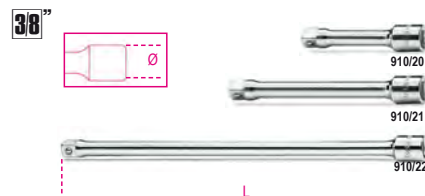

	L mm	Ø mm	CHF		
910/20	75	17	10.30	5	009100820
910/21	125	17	14.90	5	009100822
910/22	250	17	19.60	5	009100826

910AN

Rallonge angulaire carrés mâle et femelle 3/8"

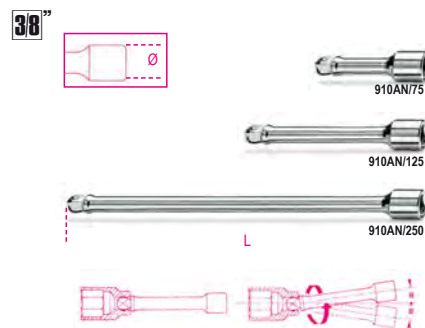

	L mm	Ø mm	CHF		
910AN/75	75	17	14.60	3	009100827
910AN/125	125	17	18.20	3	009100828
910AN/250	250	17	27.00	3	009100829

910/25

Cardan carrés mâle et femelle 3/8"



L mm	Ø mm	CHF		
54,6	19	27.00	5	009100830

910M/35

Poignée articulée carré mâle 3/8" avec manche métallique



L mm	CHF		
250	74.50	3	009100839

910/36A

Poignée articulée carré mâle 3/8"



UNI/ISO 3315 DIN 3122

L	L1	CHF		
mm	mm			
255	154	52.00	3	009100845

910/40

Poignée à béquille à cardan carré mâle 3/8"



L	L1	CHF		
mm	mm			
420	175	56.00	3	009100850

910/42

Poignée coulissante carré mâle 3/8"

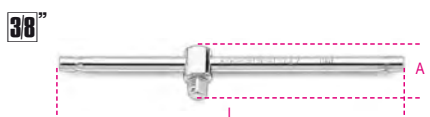

UNI/ISO 3315 DIN 3122

L	A	CHF		
mm	mm			
210	30,5	17.70	5	009100854

910/46

Vilebrequin carré mâle 3/8"

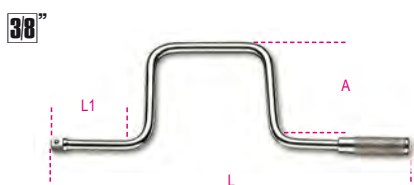

UNI/ISO 3315 DIN 3122

L	L1	A	CHF		
mm	mm	mm			
315	80	115	34.50	1	009100862

910/55

Cliquet réversible carré mâle 3/8" à 72 dents



UNI/ISO 3315 DIN 3122

L	Ø	A	CHF		
mm	mm	mm			
200	30	33	63.00	3	009100882

910/55Q

Cliquet réversible carré mâle 3/8" à 48 dents



UNI/ISO 3315 DIN 3122

L	Ø	A	CHF		
mm	mm	mm			
200	30	33	63.00	3	009100885

Voir le tableau après la ref. 928/C8 pour les pièces détachées du mécanisme de la tête de la clé dynamométrique

910M/55

Cliquet réversible carré mâle 3/8" avec manche métallique



DIN 3122 - UNI ISO 3315

L	Ø	A	CHF		
mm	mm	mm			
178	30	26	87.00	2	009100875

910M/56

Cliquet réversible à cardan carré mâle 3/8" avec manche métallique



L	Ø	A	CHF		
mm	mm	mm			
265	31	29	118.50	2	009100887

910/58

Cliquet réversible avec manche rotatif et carré mâle 3/8" mécanisme à 52 dents

- Système d'utilisation avec manche rotatif
- Touche de déverrouillage de la douille
- Système d'inversion à douille sur la tête du cliquet
- Manche bi-matériaux



L	Ø	A	CHF		
mm	mm	mm			
222	37	38,5	97.50	1	009100884

910.../C10

10 douilles et 2 accessoires



910A/C10	CHF		
	204.00	1	009100909

910A	6 - 7 - 8 - 10 - 11 - 12
	13 - 14 - 17 - 19 mm

910/21

910/55

270x120x45 mm - 1,3 kg

910B/C10	CHF		
	204.00	1	009100910

910B	6 - 7 - 8 - 10 - 11 - 12
	13 - 14 - 17 - 19 mm

910/21

910/55

270x120x45 mm - 1,3 kg

910A/C16...

16 douilles 6 pans et 5 accessoires



910A/C16	CHF		
	330.00	1	009100936

910A	6 - 7 - 8 - 9 - 10 - 11 - 12 - 13
	14 - 15 - 16 - 17 - 18 - 19

910/21

910/22

910/25

910/42

910/55

335x145x60 mm - 2,3 kg

9899 910C16	CHF		
	16.40	1	098990134

Plateau thermoformé vide

910A/C16Q	CHF		
	330.00	1	009100932

910A	6 - 7 - 8 - 9 - 10 - 11 - 12 - 13
	14 - 15 - 16 - 17 - 18 - 19

910/21

910/22

910/25

910/42

910/55Q

335x145x60 mm - 2,3 kg

9899 910C16	CHF		
	16.40	1	098990134

Plateau thermoformé vide

910B/C16...

16 douilles 6 pans et 5 accessoires

38"



910B/C16 CHF 330.00 1 009100937

- 910B 6 - 7 - 8 - 9 - 10 - 11 - 12 - 13
14 - 15 - 16 - 17 - 18 - 19
21 - 22 mm
 - 910/21 125 mm
 - 910/22 250 mm
 - 910/25
 - 910/42
 - 910/55
- 335x145x60 mm - 2,3 kg

9899 910C16 16.40 1 098990134
Plateau thermoformé vide

910B/C16Q CHF 330.00 1 009100933

- 910B 6 - 7 - 8 - 9 - 10 - 11 - 12 - 13
14 - 15 - 16 - 17 - 18 - 19
21 - 22 mm
 - 910/21 125 mm
 - 910/22 250 mm
 - 910/25
 - 910/42
 - 910/55Q
- 335x145x60 mm - 2,3 kg

9899 910C16 16.40 1 098990134
Plateau thermoformé vide

910A/C17

17 douilles 6 pans et 9 accessoires

38"



910A/C17 CHF 494.00 1 009100938

- 910A 6 - 7 - 8 - 9 - 10 - 11 - 12 - 13
14 - 15 - 16 - 17 - 18 - 19 - 20
21 - 22 mm
 - 910/15 □ 3/8 - ■ 1/4
 - 910/16 □ 3/8 - ■ 1/2
 - 910/21 125 mm
 - 910/22 250 mm
 - 910/25
 - 910/36A
 - 910/42
 - 910/46
 - 910/55
- 420x280x60 mm - 4,0 kg

910.../C29

17 douilles, 12 douilles tournevis et 5 accessoires

38"



910A/C29 CHF 565.00 1 009100944

- 910A 6 - 7 - 8 - 9 - 10 - 11 - 12 - 13
14 - 15 - 16 - 17 - 18 - 19 - 20
21 - 22 mm
 - 910LP 1x5,5 - 1,2x6,5 - 1,2x8 mm
 - ⊕ 910PH PH1 - PH2 - PH3
 - 910PE 3 - 4 - 5 - 6 - 8 - 10 mm
 - 910/21 125 mm
 - 910/22 250 mm
 - 910/25
 - 910/42
 - 910/55
- 420x185x60 mm - 3,5 kg

910B/C29 CHF 565.00 1 009100945

- 910B 6 - 7 - 8 - 9 - 10 - 11 - 12 - 13
14 - 15 - 16 - 17 - 18 - 19 - 20
21 - 22 mm
 - 910LP 1x5,5 - 1,2x6,5 - 1,2x8 mm
 - ⊕ 910PH PH1 - PH2 - PH3
 - 910PE 3 - 4 - 5 - 6 - 8 - 10 mm
 - 910/21 125 mm
 - 910/22 250 mm
 - 910/25
 - 910/42
 - 910/55
- 420x185x60 mm - 3,5 kg

910AS/C13...

13 douilles 12 pans et 5 accessoires

38"



910AS/C13 CHF 332.00 1 009100925

- 910AS 1/4 - 5/16 - 11/32 - 3/8 - 7/16
1/2 - 9/16 - 19/32 - 5/8 - 11/16
3/4 - 13/16 - 7/8
 - 910/21 125 mm
 - 910/22 250 mm
 - 910/42
 - 910/25
 - 910/55
- 335x145x60 mm - 2,3 kg

910AS/MBM-C18

13 douilles 12 pans et 5 accessoires pour maintenance aéronautique

38"



910AS/MBM-C18 CHF 347.00 1 009100926

- 910AS 1/4 - 5/16 - 11/32 - 3/8 - 7/16
1/2 - 9/16 - 19/32 - 5/8 - 11/16
3/4 - 13/16 - 7/8
 - 910/21 125 mm
 - 910/22 250 mm
 - 910/25
 - 910/42
 - 910M/55
- 335x145x60 mm - 2,5 kg

910A/C16HR

16 douilles 6 pans et 5 accessoires

• cliquet avec branche rotative

38"



910A/C16HR CHF 363.00 1 009100935

- 910A 6 - 7 - 8 - 9 - 10 - 11 - 12 - 13
14 - 15 - 16 - 17 - 18 - 19
21 - 22 mm
 - 910/21 125 mm
 - 910/22 250 mm
 - 910/25
 - 910/42 210 mm
 - 910/58
- 335x145x60 mm - 2,4 kg



920A

Douille 6 pans



UNI/ISO 2725 DIN 3124

mm	Ø	L	Ø1	CHF		
8	12,4	38	21,7	8.05	10	009200008
9	13,5	38	21,7	8.05	10	009200009
10	14,9	38	21,7	8.05	10	009200010
11	16,1	38	21,7	8.05	10	009200011
12	17,5	38	21,7	8.05	10	009200012
13	18,7	38	21,7	8.35	10	009200013
14	20,1	38	21,7	8.35	10	009200014
15	21,5	38	22,5	8.35	10	009200015
16	22,7	38	23,7	9.35	10	009200016
17	24,1	38	23,1	9.35	10	009200017
18	25,3	39	24,0	9.35	10	009200018
19	26,6	39	24,0	9.35	10	009200019
20	27,8	40	25,0	10.20	5	009200020
21	28,8	40	25,0	10.20	5	009200021
22	29,9	41	26,0	10.20	5	009200022
23	30,8	42	26,0	11.90	5	009200023
24	32,2	43	27,0	11.90	5	009200024
25	33,2	44	27,0	11.90	5	009200025
26	34,7	45	28,0	12.30	5	009200026
27	36,2	46	29,0	12.30	5	009200027
28	37,2	47	30,0	12.30	5	009200028
29	38,6	48	31,0	12.80	5	009200029
30	40,2	48	32,0	12.80	5	009200030
32	42,3	49	34,0	13.50	5	009200032



920A/SB13	CHF		
10-11-12-13-14-15-16	140.00	1	009200040
17-18-19-20-21-22 mm			



920A/SB8	CHF		
23-24-25-26-27-28-30-32 mm	114.50	1	009200042

920MC

Douille 6 pans, colorée

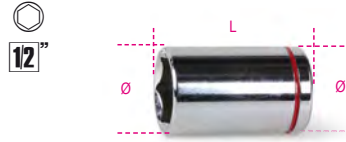

mm	Ø	L	Ø1	CHF		
8	13,2	38	22	8.75	5	009202008
10	15,3	38	22	8.75	5	009202010
11	16,5	38	22	8.75	5	009202011
12	17,8	38	22	8.75	5	009202012
13	19,0	38	22	9.20	5	009202013
14	20,3	38	22	9.20	5	009202014
15	21,6	38	22	9.20	5	009202015
16	23,0	38	23	10.20	5	009202016
17	23,9	38	24	10.20	5	009202017
18	25,0	38	25	10.20	5	009202018
19	26,5	38	24	10.20	5	009202019
21	28,8	38	27	11.10	3	009202021
22	29,9	40	28	11.10	3	009202022
24	32,8	40	30	12.90	3	009202024

920B

Douille 12 pans

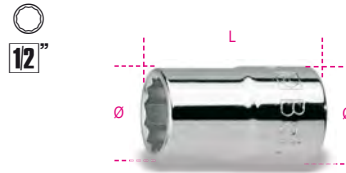

UNI/ISO 2725 DIN 3124

mm	Ø	L	Ø1	CHF		
8	12,4	38	21,7	8.05	10	009200108
9	13,5	38	21,7	8.05	10	009200109
10	14,9	38	21,7	8.05	10	009200110
11	16,1	38	21,7	8.05	10	009200111
12	17,5	38	21,7	8.05	10	009200112
13	18,7	38	21,7	8.35	10	009200113
14	20,1	38	21,7	8.35	10	009200114
15	21,5	38	22,5	8.35	10	009200115
16	22,7	38	23,7	9.35	10	009200116
17	24,1	38	23,1	9.35	10	009200117
18	25,3	39	24,0	9.35	10	009200118
19	26,6	39	24,0	9.35	10	009200119
20	27,8	40	25,0	10.20	5	009200120
21	28,8	40	25,0	10.20	5	009200121
22	29,9	41	26,0	10.20	5	009200122
23	30,8	42	26,0	11.90	5	009200123
24	32,2	43	27,0	11.90	5	009200124
25	33,2	44	27,0	11.90	5	009200125
26	34,7	45	28,0	12.30	5	009200126
27	36,2	46	29,0	12.30	5	009200127
28	37,2	47	30,0	12.30	5	009200128
29	38,6	48	31,0	12.80	5	009200129
30	40,2	48	32,0	12.80	5	009200130
32	42,3	49	33,9	13.50	5	009200132



920B/SB13	CHF		
10-11-12-13-14-15-16	140.00	1	009200140
17-18-19-20-21-22 mm			

920B/SB8	CHF		
23-24-25-26-27	114.50	1	009200142
28-30-32 mm			

920AL

Douille 6 pans série longue 1/2



UNI/ISO 2725 DIN 3124

mm	Ø	L	Ø1	CHF		
10	14,7	77	21	22.00	5	009200626
12	17,8	77	21	22.00	5	009200627
13	19,0	77	22	22.00	5	009200628
14	20,3	77	22	22.00	5	009200629
15	21,5	77	22	22.00	5	009200630
16	22,8	77	22	23.60	5	009200631
17	24,0	77	23	23.60	5	009200632
18	25,0	77	24	24.80	5	009200633
19	26,5	77	25	24.80	5	009200634
21	29,0	77	27	27.50	5	009200635
22	30,0	77	28	27.50	5	009200636
23	31,5	77	29	27.50	5	009200637
24	32,8	77	30	31.50	5	009200638
27	36,5	77	33	33.00	3	009200639
30	40,0	77	36	39.50	3	009200640
32	42,8	77	38	40.50	3	009200641
36	48,0	77	41	65.00	3	009200642



920AL/SB11	CHF		
10-12-13-14-15-16	282.00	1	009200644
17-18-19-21-22 mm			

920BL

Douille 12 pans série longue



UNI/ISO 2725 DIN 3124

mm	Ø	L	Ø1	CHF		
10	14,7	77	21	22.00	5	009200310
12	17,8	77	21	22.00	5	009200312
13	19,0	77	22	22.00	5	009200313
14	20,3	77	22	22.00	5	009200314
15	21,5	77	22	22.00	5	009200315
16	22,8	77	22	23.60	5	009200316
17	24,0	77	23	23.60	5	009200317
18	25,0	77	24	24.80	5	009200318
19	26,5	77	25	24.80	5	009200319
21	29,0	77	27	27.50	5	009200321
22	30,0	77	28	27.50	5	009200322
23	31,5	77	29	27.50	5	009200323
24	32,8	77	30	31.50	5	009200324
27	36,5	77	33	33.00	3	009200327
30	40,0	77	36	39.50	3	009200330
32	42,8	77	38	40.50	3	009200332
36	48,0	77	41	65.00	3	009200336



920BL/SB11	CHF		
10-12-13-14-15-16-17-18	282.00	1	009200338
19-21-22 mm			



920A/AS

Douille 6 pans



"	Ø mm	L mm	Ø1 mm	CHF	🔧	📦
3/8	14,6	37	21	9.45	2	009200270
7/16	16,5	37	21	9.45	3	009200272
1/2	19,0	37	22	9.75	3	009200273
9/16	20,3	37	22	9.75	3	009200274
19/32	21,0	37	22	10.50	3	009200275
5/8	22,8	37	22	10.50	3	009200276
11/16	25,0	37	24	10.80	3	009200277
3/4	26,5	38	25	10.80	3	009200279
25/32	28,0	38	26	12.10	3	009200280
13/16	29,0	38	27	12.10	3	009200281
7/8	30,0	40	28	12.10	3	009200282
15/16	32,8	42	30	12.90	3	009200284
1	35,0	42	32	12.90	3	009200285
1.1/16	36,5	43	33	14.10	2	009200287
1.1/8	39,0	43	35	14.60	2	009200289
1.3/16	41,0	46	36	15.80	2	009200290
1.1/4	42,8	46	38	16.00	2	009200292



920A-AS/SB11
 CHF 140.50 1 009200295
 3/8-7/16-1/2-9/16-5/8
 11/16-3/4-13/16-7/8
 15/16-1

920AS

Douille 12 pans

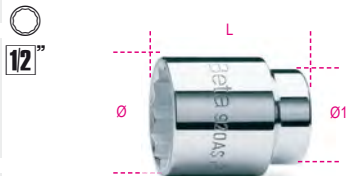

"	Ø mm	L mm	Ø1 mm	CHF	🔧	📦
3/8	14,9	38	21,7	9.45	3	009200201
7/16	16,1	38	21,7	9.45	3	009200202
1/2	18,7	38	21,7	9.75	3	009200203
9/16	20,1	38	21,7	9.75	3	009200204
5/8	22,7	38	22,5	10.50	3	009200206
19/32	21,5	38	23,7	10.50	3	009200207
11/16	25,3	39	24,0	10.80	3	009200208
3/4	26,6	39	24,0	10.80	3	009200209
25/32	27,8	40	25,0	12.10	3	009200210
13/16	28,8	40	25,0	12.10	3	009200211
7/8	29,9	41	26,0	12.10	3	009200212
15/16	32,2	43	27,0	12.90	3	009200214
1	34,2	45	28,0	12.90	3	009200216
1.1/16	36,2	46	29,0	14.10	2	009200217
1.1/8	38,6	48	31,0	14.60	2	009200218
1.3/16	40,2	48	32,0	15.80	2	009200219
1.1/4	42,3	49	33,5	16.00	2	009200220



920AS/SB11
 CHF 140.50 1 009200225
 3/8-7/16-1/2-9/16-5/8
 11/16-3/4-13/16-7/8
 15/16-1

920AS/L

Douille 12 pans série longue



"	Ø mm	L mm	Ø1 mm	CHF	🔧	📦
1/2	19,0	77	22	30.00	2	009200352
9/16	20,3	77	22	30.00	2	009200353
5/8	22,8	77	22	30.00	2	009200355
11/16	25,0	77	24	32.00	2	009200357
3/4	26,5	77	25	33.00	2	009200358
13/16	29,0	77	27	39.00	2	009200360
7/8	30,0	77	28	39.00	2	009200361
15/16	32,8	77	30	40.50	2	009200362
1	35,0	77	32	41.50	2	009200363
1.1/16	36,5	77	33,0	45.00	2	009200364
1.1/8	37,8	77	34	46.50	2	009200365



920ASL/SB11
 CHF 428.00 1 009200369
 1/2-9/16-5/8-11/16
 3/4-13/16-7/8-15/16
 1-1.1/8-1.1/16

920U

Douille multi-empreinte



mm	"	Ø	Ø1	L mm	CHF	🔧	📦
10	3/8	E12	M12	38	8.45	5	009201710
11	7/16	E14	M14	38	8.45	5	009201711
12	15/32	E16		38	8.45	5	009201712
13	1/2	M16		38	8.85	5	009201713
14	9/16	E18	M18	38	8.85	5	009201714
15	19/32			38	8.85	5	009201715
16	5/8	E20		38	9.80	5	009201716
17				38	9.80	5	009201717
18		E22		38	9.80	5	009201718
19	3/4	E24		38	9.80	5	009201719
20	25/32			38	10.90	3	009201720
21				38	10.90	3	009201721
22	7/8			38	10.90	3	009201722
24	15/16			38	12.40	3	009201724
27	1.1/16			42	13.00	3	009201727
30	1.1/8			44	13.80	3	009201730
32	1.1/4			44	14.30	3	009201732



920U/SB13
 CHF 147.00 1 009201740
 10-11-12-13-14-15-16
 17-18-19-20-21-22 mm



920U/SB4
 CHF 63.00 1 009201744
 24-27-30-32 mm

920FTX

Douille pour écrous Torx®

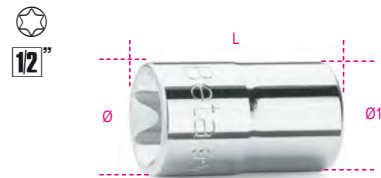

Ø mm	L mm	Ø1 mm	CHF	🔧	📦	
E10	13,2	36	21	13.30	5	009200380
E12	15,0	37	21	13.30	5	009200381
E14	16,3	37	21	13.30	5	009200382
E16	18,8	37	22	13.30	5	009200383
E18	20,4	37	22	13.30	5	009200384
E20	22,9	37	22	14.50	5	009200385
E22	25,0	37	24	16.70	3	009200387
E24	26,5	40	25	19.00	3	009200388



920FTX/SB6
 CHF 93.50 1 009200390
 E10-E12-E14
 E16-E18-E20



920FTX/C8
 CHF 159.50 1 009200391
 E10-E12-E14-E16
 E18-E20-E22-E24

270X120X45 mm - 1 kg

920FTX/L

Douille pour écrous Torx®, série longue



Ø mm	L mm	Ø1 mm	CHF	🔧	📦	
E10	13,2	77	21,0	28.00	5	009200400
E12	15,0	77	21,0	28.00	5	009200401
E14	16,3	77	21,0	28.00	5	009200402
E16	18,8	77	21,8	28.00	3	009200403
E18	20,4	77	21,8	28.00	3	009200404
E20	22,9	77	22,0	28.00	3	009200405



920FTX-LSB6
 CHF 180.50 1 009200409
 E10-E12-E14
 E16-E18-E20

920LP

Douille tournevis pour vis à fente

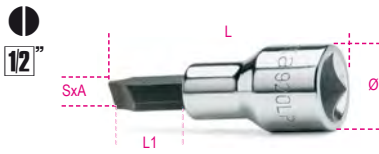

SxA mm	Ø mm	L mm	L1 mm	CHF	Hand	Icon
1x5,5	22,5	62	24	21.70	3	009200452
1,2x6,5	22,5	62	24	21.70	3	009200453
1,2x8	22,5	62	24	21.70	3	009200454
1,6x9	22,5	62	24	21.70	3	009200456
2x12	22,5	62	24	21.70	3	009200458

920PH

Douille tournevis pour vis Phillips®

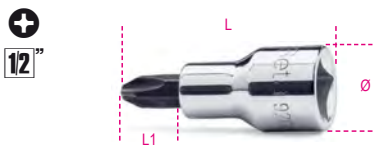

PH	Ø mm	L mm	L1 mm	CHF	Hand	Icon
1	22,5	56	18	19.10	3	009200471
2	22,5	56	18	19.10	3	009200472
3	22,5	56	18	19.10	3	009200473
4	22,5	56	18	19.10	3	009200474



920PH/SB4	CHF	Hand	Icon
PH1-PH2-PH3-PH4	86.00	1	009200479

920LH/SB7

Douille tournevis pour vis Phillips®



920LH/SB7	CHF	Hand	Icon
920LP 1,2x6,5 - 1,2x8 1,6x9 - 2x12 mm 920PH PH2 - PH3 - PH4	158.00	1	009200478

920PE

Douille tournevis pour vis 6 pans creux

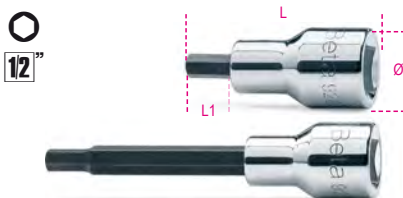

DIN 7422	mm	Ø mm	L mm	L1 mm	CHF	Hand	Icon
	3	22,5	58	20	17.40	5	009200410
	4	22,5	58	20	17.40	5	009200412
	5	22,5	58	20	17.40	5	009200414

mm	Ø mm	L mm	L1 mm	CHF	Hand	Icon
5L	22,5	100	62	19.00	5	009200415
6	22,5	58	20	17.40	5	009200417
6L	22,5	100	62	19.00	5	009200418
7	22,5	58	20	17.40	5	009200420
7L	22,5	100	62	19.00	5	009200421
8	22,5	58	20	17.40	5	009200423
8L	22,5	100	62	19.00	5	009200424
9	22,5	58	20	17.40	5	009200425
9L	22,5	140	102	20.00	5	009200426
10	22,5	58	20	17.40	5	009200428
10L	22,5	140	102	20.00	5	009200429
12	23,0	58	20	20.20	5	009200432
12L	22,5	140	102	23.10	5	009200433
14	23,0	58	20	20.20	5	009200434
14L	22,5	140	102	23.10	5	009200435
17	29,5	60	22	24.70	5	009200437
19	29,5	60	22	24.70	5	009200439



920PE/SB9	CHF	Hand	Icon
4-5-6-8-10 mm 5L-6L-8L-10L mm	180.50	1	009200441



920PE/C10	CHF	Hand	Icon
4-5-6-7-8-10 12-14-17-19 mm	237.00	1	009200443

270X120X45 mm - 1,5 kg

9899 920PE/C10	CHF	Hand	Icon
Plateau thermoformé vide	16.40	1	098990135

920PE/AS

Douille tournevis pour vis 6 pans creux



"	Ø mm	L mm	L1 mm	CHF	Hand	Icon
1/8	22,5	58	20	20.30	2	009200460
3/16	22,5	58	20	20.30	2	009200461
1/4	22,5	58	20	20.30	2	009200463
3/8	22,5	58	20	20.30	2	009200464
1/2	22,5	60	20	22.20	2	009200465
3/4	22,5	60	20	23.80	1	009200468



920PE/AS/SB6	CHF	Hand	Icon
1/8-3/16-1/4-3/8-1/2-3/4	140.00	1	009200469

920BP

Douille tournevis à tête sphérique pour vis 6 pans creux

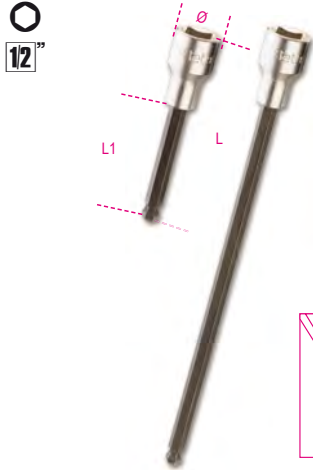

mm	Ø mm	L mm	L1 mm	CHF	Hand	Icon
5L	22,5	100	62	21.80	5	009200490
5XL	22,5	240	202	28.00	1	009200495
6L	22,5	100	62	21.80	5	009200491
6XL	22,5	240	202	28.00	1	009200496
7L	22,5	100	62	21.80	5	009200492
8L	22,5	100	62	21.80	5	009200493
8XL	22,5	240	202	28.00	1	009200497
10L	22,5	140	102	23.80	5	009200494



920BP/SB8	CHF	Hand	Icon
5L-6L-7L-8L-10L mm 5XL-6XL-8XL mm	211.50	1	009200500

920ME

Douille tournevis pour vis 6 pans creux



mm	Ø mm	L mm	L1 mm	CHF	Hand	Icon
5	21	75	15,5	20.30	5	009200505
6	21	75	15,5	20.30	5	009200506
7	21	75	15,5	20.30	5	009200507
8	21	75	15,5	20.30	5	009200508
10	23	75	15,5	21.20	5	009200510
12	24	75	15,5	24.40	5	009200512
14	24	75	15,5	25.00	5	009200514
17	24	75	15,5	25.00	5	009200517



920ME/SB7	CHF	Hand	Icon
5-6-8-10-12-14-17 mm	171.00	1	009200519

12



920ME/C7
5-6-8-10-12-14-17 mm
250X100X35 mm - 1,4 kg

CHF 194.00 1 009200518

920TX

Douille tournevis pour vis Torx®

12



	Ø mm	L mm	L1 mm	CHF		
T20	22,5	58	20	21.20	5	009200520
T20L	22,5	120	82	27.00	3	009200530
T25	22,5	58	20	21.20	5	009200521
T25L	22,5	120	82	27.00	3	009200531
T27	22,5	58	20	21.20	5	009200522
T27L	22,5	120	82	27.00	3	009200532
T30	22,5	58	20	21.20	5	009200523
T30L	22,5	120	82	27.00	3	009200533
T40	22,5	58	20	21.20	5	009200524
T40L	22,5	120	82	27.00	3	009200534
T45	22,5	58	20	21.20	5	009200525
T45L	22,5	120	82	27.00	3	009200535
T50	22,5	58	20	21.20	5	009200526
T50L	23,0	140	102	27.00	3	009200538
T55	23,0	58	20	28.50	3	009200527
T55L	23,0	140	102	38.50	3	009200539
T60	23,0	58	20	28.50	3	009200528
T60L	23,0	140	102	38.50	3	009200540
T70L	23,0	120	82	38.50	3	009200541

12



920TX-SB9
T20-T25-T27-T30
T40-T45-T50-T55-T60

CHF 222.00 1 009200532



920TX-L/SB10
T20L-T25L-T27L-T30L-T40L-
T45L-T50L-T55L-T60L-T70L

CHF 325.00 1 009200545

12



920TX/C9
T20-T25-T27-T30-T40
T45-T50-T55-T60
270X120X45 mm - 1,2 kg

CHF 248.00 1 009200546

9899 920TX/C9
Plateau thermoformé vide

CHF 16.40 1 098990136

920RTX

Douille tournevis pour vis
Tampér Résistant Torx®

12



	Ø mm	L mm	L1 mm	CHF		
T20	22,5	58	20	22.70	5	009200370
T25	22,5	58	20	22.70	5	009200371
T27	22,5	58	20	22.70	5	009200372
T30	22,5	58	20	22.70	5	009200373
T40	22,5	58	20	22.70	5	009200374

12



920RTX/SB5
T20-T25-T27-T30-T40

CHF 124.50 1 009200378

920XZN

Douille tournevis pour vis XZN®

12

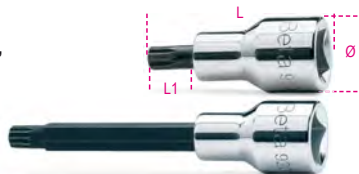

DIN 2324

	Ø mm	L mm	L1 mm	CHF		
M4	22,5	58	20	22.80	3	009200559
M5	22,5	58	20	22.80	3	009200560
M6	22,5	58	20	22.80	3	009200561
M6L	22,5	100	62	26.00	3	009200562
M8	22,5	58	20	22.80	3	009200563
M8L	22,5	100	62	26.00	3	009200564
M9	22,5	58	20	22.80	3	009200582
M9L	22,5	100	62	26.00	3	009200583
M10	22,5	58	20	23.10	3	009200565
M10L	22,5	100	62	26.00	3	009200566
M12	22,5	58	20	23.80	3	009200568
M12L	22,5	100	62	26.50	3	009200569
M14	23,0	58	20	23.80	3	009200571
M14L	23,0	100	62	26.50	3	009200572
M16	23,0	58	20	29.50	3	009200573
M18	23,0	58	20	30.00	3	009200574

12



920XZN/SB7
M4-M5-M6-M8
M10-M12-M14

CHF 176.00 1 009200579

12



920XZN/SB12
M5-M6-M8-M10-M12
M14-M16-M6L-M8L
M10L-M12L-M14L

CHF 322.00 1 009200577

12



920XZN-L/S5
M6L-M8L-M10L
M12L-M14L

CHF 131.50 1 009200578

920ES

Douille pour vis à 6 cannelures

12



UNI 9326

Ø mm		L mm	L1 mm	CHF		
7	(6R)	58	20	31.50	5	009200587
7XL	(6R)	240	202	44.50	1	009200607
9	(8R)	58	20	31.50	5	009200589
9XL	(8R)	240	202	44.50	1	009200609
10	(8S)	58	20	31.50	5	009200590
10XL	(8S)	240	202	44.50	1	009200610
11	(10R)	58	20	31.50	5	009200591
11XL	(10R)	240	202	44.50	1	009200611
12L	(10S)	100	62	36.00	3	009200592
12XL	(10S)	240	202	49.00	1	009200612
14L	(12S)	100	62	36.00	3	009200594
14XL	(12S)	240	202	49.00	1	009200614
16L	(14R)	100	62	36.00	3	009200596
16XL	(14R)	240	202	49.00	1	009200616

12



920ES/SB7
7-9-10-11-12L-14L-16L

CHF 248.50 1 009200598

12



920ES-XL/SB7
7XL-9XL-10XL-11XL
12XL-14XL-16XL

CHF 340.00 1 009200618

PM 1/2-Q5

12



PM 1/2-Q5 72,519

920/15

Réducteur carré femelle 1/2" et mâle 3/8"



UNI/ISO 3316 DIN 3123

L mm	□	■	Ø mm	CHF	🔧	📄
42	1/2	3/8	22,0	13.60	5	009200810



Toujours appliquer la force de serrage régulièrement et progressivement afin d'éviter la rupture et de se protéger contre un possible accident.

920/16

Augmentateur carré femelle 1/2" et mâle 3/4"



UNI/ISO 3316 DIN 3123

L mm	□	■	Ø mm	CHF	🔧	📄
46	1/2	3/4	26	17.90	5	009200814

920/20÷920/23

Rallonge carrés mâle et femelle 1/2"



UNI/ISO 3316 DIN 3123

	L mm	Ø mm	CHF	🔧	📄
920/20	75	22	16.60	5	009200818
920/21	125	22	20.30	5	009200822
920/22	255	22	23.10	5	009200826
920/23	375	22	31.00	2	009200827

920AN

Rallonge angulaire carrés mâle et femelle 1/2"

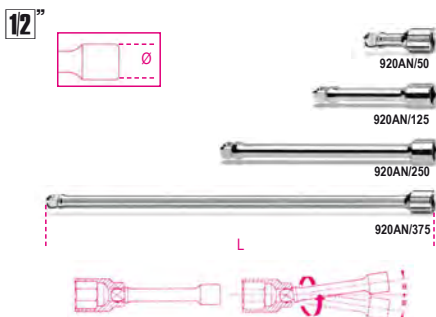

	L mm	Ø mm	CHF	🔧	📄
920AN/50	50	22	17.90	5	009200833
920AN/125	125	22	24.60	5	009200834
920AN/250	250	22	34.50	3	009200835
920AN/375	375	22	46.00	3	009200836

920/25

Cardan carrés mâle et femelle 1/2"



UNI/ISO 3316 DIN 3123

L mm	Ø mm	CHF	🔧	📄
75	27	32.00	5	009200830

920/35A

Poignée articulée carré mâle 1/2"



UNI/ISO 3315 DIN 3122

L mm	L1 mm	CHF	🔧	📄
285	160	64.50	3	009200846

920M/35

Poignée articulée carré mâle 1/2" avec manche métallique



UNI/ISO 3315 DIN 3122

L mm	CHF	🔧	📄
380	92.50	2	009200845

920M/35L

Poignée articulée carré mâle 1/2" avec manche métallique, série longue

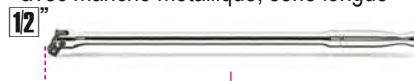

UNI/ISO 3315 DIN 3122

L mm	CHF	🔧	📄
600	139.50	1	009200843



Toujours appliquer la force de serrage régulièrement et progressivement afin d'éviter la rupture et de se protéger contre un possible accident.

920/36A

Poignée articulée carré mâle 1/2"



UNI/ISO 3315 DIN 3122

L mm	L1 mm	CHF	🔧	📄
408	283	72.50	2	009200847

920/38

Poignée articulée extensible, carré mâle 1/2"



L mm	L max mm	CHF	🔧	📄
262	402	109.50	1	009200839

920/40

Poignée à béquille à cardan carré mâle 1/2"

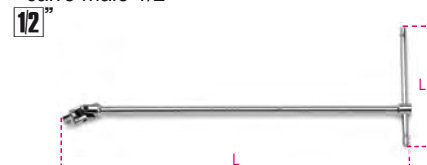

L mm	L1 mm	CHF	🔧	📄
490	230	75.50	2	009200850

920/42

Poignée coulissante carré mâle 1/2"

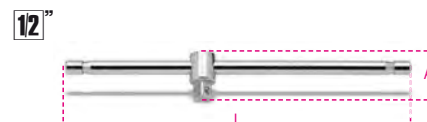

UNI/ISO 3315 DIN 3122

L mm	A mm	CHF	🔧	📄
305	42	22.80	5	009200854

920/44

Poignée coudée carré mâle 1/2"



UNI/ISO 3315 DIN 3122

L mm	L1 mm	CHF	🔧	📄
230	60	33.50	3	009200858

920/46

Vilebrequin carré mâle 1/2"

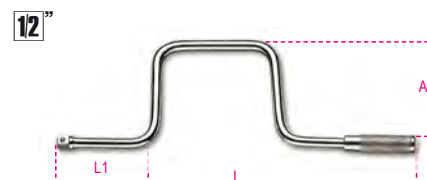

UNI/ISO 3315 DIN 3122

L mm	L1 mm	A mm	CHF	🔧	📄
385	110	160	41.50	1	009200862

920/50

Cliquet réversible à glissière carré mâle 1/2" à 72 dents



UNI/ISO 3315 DIN 3122

L	Ø	A	CHF	3	009200871
mm	mm	mm	72.00		
275	40	42			

920/50F

Cliquet avec carré femelle 1/2" à 72 dents



UNI/ISO 3315 DIN 3122

L	Ø	A	CHF	2	009200889
mm	mm	mm	66.50		
275	40	27			

920/55

Cliquet réversible carré mâle 1/2" à 72 dents



UNI/ISO 3315 DIN 3122

L	Ø	A	CHF	3	009200882
mm	mm	mm	77.00		
275	40	43			

920/550

Cliquet réversible carré mâle 1/2" à 48 dents



UNI/ISO 3315 DIN 3122

L	Ø	A	CHF	3	009200885
mm	mm	mm	77.00		
275	40	43			

920/55X

Cliquet réversible carré mâle 1/2" à 72 dents



UNI/ISO 3315 DIN 3122

L	Ø	A	CHF	3	009200895
mm	mm	mm	65.50		
200	30	33			

920/55LC

Cliquet réversible carré mâle 1/2" à 72 dents avec système de verrouillage



UNI/ISO 3315 DIN 3122

L	Ø	A	CHF	2	009200896
mm	mm	mm	89.00		
275	40	43			

920M/55

Cliquet réversible carré mâle 1/2" avec manche métallique



L	Ø	A	CHF	1	009200893
mm	mm	mm	99.00		
253	38	35			

920/56A

Cliquet réversible à cardan carré mâle 1/2" à 72 dents



L	Ø	A	CHF	1	009200911
mm	mm	mm	126.50		
315	40	43			

920M/56

Cliquet réversible à cardan carré mâle 1/2" avec manche métallique



L	Ø	A	CHF	2	009200894
mm	mm	mm	132.00		
330	38	35,7			

920/58

Cliquet réversible avec manche rotatif et carré mâle 1/2" mécanisme à 52 dents

- Système d'utilisation avec poignée tournante
- Touche de déverrouillage de la douille
- Système d'inversion à douille sur la tête du cliquet
- Manche bi-matières



L	Ø	A	CHF	1	009200926
mm	mm	mm	116.00		
281	42,5	45			

Voir le tableau après la ref. 928/C8 pour les pièces détachées du mécanisme de la tête de la clé dynamométrique



920.../C11

11 douilles et 2 accessoires

12"



920A/C11 CHF 243.50 1 009200921

	○ 920A	10 - 12 - 13 - 14 - 15 - 16 17 - 18 - 19 - 21 - 22 mm
	920/22	255 mm
	920/50	
≡ 335x145x60 mm - 2,5 kg		

920B/C11 CHF 243.50 1 009200922

	○ 920B	10 - 12 - 13 - 14 - 15 - 16 17 - 18 - 19 - 21 - 22 mm
	920/22	255 mm
	920/50	
≡ 335x145x60 mm - 2,5 kg		

920.../C12...

12 douilles et 5 accessoires

12"



920A/C12X CHF 356.00 1 009200933

	○ 920A	10 - 11 - 12 - 13 - 14 - 17 - 19 22 - 24 - 27 - 30 - 32 mm
	920/21	125 mm
	920/22	255 mm
	920/25	
	920/42	
	920/55	
≡ 420x185x60 mm - 4,2 kg		

9899 920C12 16.40 1 098990116
Plateau thermoformé vide

920A/C12 CHF 351.00 1 009200931

	○ 920A	10 - 11 - 12 - 13 - 14 - 17 - 19 22 - 24 - 27 - 30 - 32 mm
	920/21	125 mm
	920/22	255 mm
	920/25	
	920/42	
	920/50	
≡ 420x185x60 mm - 4,2 kg		

9899 920C12 16.40 1 098990116
Plateau thermoformé vide

920B/C12X CHF 356.00 1 009200934

	○ 920B	10 - 11 - 12 - 13 - 14 - 17 - 19 22 - 24 - 27 - 30 - 32 mm
	920/21	125 mm
	920/22	255 mm
	920/25	
	920/42	
	920/55	

≡ 420x185x60 mm - 4,0 kg

9899 920C12 16.40 1 098990116
Plateau thermoformé vide

920B/C12 CHF 351.00 1 009200932

	○ 920B	10 - 11 - 12 - 13 - 14 - 17 - 19 22 - 24 - 27 - 30 - 32 mm
	920/21	125 mm
	920/22	255 mm
	920/25	
	920/42	
	920/50	

≡ 420x185x60 mm - 4,0 kg

9899 920C12 16.40 1 098990116
Plateau thermoformé vide

920MC/C14

14 douilles 6 pans colorées et 5 accessoires

12"



920MC/C14 CHF 374.00 1 009202964

	○ 920MC	8 - 10 - 11 - 12 - 13 - 14 - 15 - 16 - 17 - 18 - 19 - 21 - 22 - 24 mm
	920/21	125 mm
	920/22	255 mm
	920/25	
	920/42	
	920/55	

≡ 420x185x60 mm - 4,2 kg

920.../C20...

20 douilles et 5 accessoires

12"



920A/C20X CHF 440.00 1 009200950

	○ 920A	10 - 11 - 12 - 13 - 14 - 15 - 16 17 - 18 - 19 - 20 - 21 - 22 - 23 24 - 26 - 27 - 28 - 30 - 32 mm
	920/21	125 mm
	920/22	255 mm
	920/25	
	920/42	
	920/55	

≡ 420x185x60 mm - 5,1 kg

9899 920C20 16.40 1 098990121
Plateau thermoformé vide

920A/C20 CHF 435.00 1 009200948

	○ 920A	10 - 11 - 12 - 13 - 14 - 15 - 16 17 - 18 - 19 - 20 - 21 - 22 - 23 24 - 26 - 27 - 28 - 30 - 32 mm
	920/21	125 mm
	920/22	255 mm
	920/25	
	920/42	
	920/50	

≡ 420x185x60 mm - 5,1 kg

9899 920C20 16.40 1 098990121
Plateau thermoformé vide

920A/C20Q CHF 440.00 1 009200955

	○ 920A	10 - 11 - 12 - 13 - 14 - 15 - 16 17 - 18 - 19 - 20 - 21 - 22 - 23 24 - 26 - 27 - 28 - 30 - 32 mm
	920/21	125 mm
	920/22	255 mm
	920/25	
	920/42	
	920/55Q	

≡ 420x185x60 mm - 5,1 kg

9899 920C20 16.40 1 098990121
Plateau thermoformé vide

920B/C20 CHF 435.00 1 009200949

	○ 920B	10 - 11 - 12 - 13 - 14 - 15 - 16 17 - 18 - 19 - 20 - 21 - 22 - 23 24 - 26 - 27 - 28 - 30 - 32 mm
	920/21	125 mm
	920/22	255 mm
	920/25	
	920/42	
	920/50	

≡ 420x185x60 mm - 5,0 kg

9899 920C20 16.40 1 098990121
Plateau thermoformé vide



920B/C20X	CHF 440.00			1 009200951
920B	10 - 11 - 12 - 13 - 14 - 15 - 16 17 - 18 - 19 - 20 - 21 - 22 - 23 24 - 26 - 27 - 28 - 30 - 32 mm			
920/21	125 mm			
920/22	255 mm			
920/25				
920/42				
920/55				
	420x185x60 mm - 5,0 kg			

9899 920C20	CHF 16.40			1 098990121
Plateau thermoformé vide				

920.../C21...

21 douilles et 6 accessoires

12"



920A/C21	CHF 506.00			1 009200952
920A	10 - 11 - 12 - 13 - 14 - 15 - 16 17 - 18 - 19 - 20 - 21 - 22 - 23 24 - 25 - 26 - 27 - 28 - 30 - 32 mm			
920/21	125 mm			
920/22	255 mm			
920/25				
920/42				
920/46				
920/50				
	420x280x60 mm - 6,5 kg			

920A/C21X	CHF 511.00			1 009200983
920A	10 - 11 - 12 - 13 - 14 - 15 - 16 17 - 18 - 19 - 20 - 21 - 22 - 23 24 - 25 - 26 - 27 - 28 - 30 - 32 mm			
920/21	125 mm			
920/22	255 mm			
920/25				
920/42				
920/46				
920/55				
	420x280x60 mm - 6,4 kg			

920B/C21	CHF 506.00			1 009200953
920B	10 - 11 - 12 - 13 - 14 - 15 - 16 17 - 18 - 19 - 20 - 21 - 22 - 23 24 - 25 - 26 - 27 - 28 - 30 - 32 mm			
920/21	125 mm			
920/22	255 mm			
920/25				
920/42				
920/46				
920/50				
	420x280x60 mm - 6,4 kg			

920B/C21X	CHF 511.00			1 009200984
920B	10 - 11 - 12 - 13 - 14 - 15 - 16 17 - 18 - 19 - 20 - 21 - 22 - 23 24 - 25 - 26 - 27 - 28 - 30 - 32 mm			
920/21	125 mm			
920/22	255 mm			
920/25				
920/42				
920/46				
920/55				
	420x280x60 mm - 6,4 kg			

920B/C300

30 douilles 12 pans et 5 accessoires

12"



920B/C30Q	CHF 722.00			1 009200975
920B	8 - 9 - 10 - 11 - 12 - 13 - 14 15 - 16 - 17 - 18 - 19 - 20 - 21 22 - 23 - 24 - 26 - 27 - 30 mm			
920BL	12 - 13 - 14 - 17 - 19 - 21 22 - 24 - 27 - 30 mm			
920/21	125 mm			
920/22	255 mm			
920/25				
920/42				
920/55Q				
	420x280x60 mm - 7,6 kg			



920.../C33

20 douilles, 13 douilles tournevis et 5 accessoires

12"



920A/C33	CHF 708.00			1 009200985
920A	10 - 11 - 12 - 13 - 14 - 15 - 16 17 - 18 - 19 - 20 - 21 - 22 - 23 24 - 26 - 27 - 28 - 30 - 32 mm			
920LP	1,2x8 - 1,6x9 - 2x12 mm			
920PH	PH2 - PH3 - PH4			
920PE	4 - 5 - 6 - 8 - 10 - 12 - 14 mm			
920/21	125 mm			
920/22	255 mm			
920/25				
920/42				
920/55				
	420x280x60 mm - 6,7 kg			

920B/C33	CHF 708.00			1 009200986
920B	10 - 11 - 12 - 13 - 14 - 15 - 16 17 - 18 - 19 - 20 - 21 - 22 - 23 24 - 26 - 27 - 28 - 30 - 32 mm			
920LP	1,2x8 - 1,6x9 - 2x12 mm			
920PH	PH2 - PH3 - PH4			
920PE	4 - 5 - 6 - 8 - 10 - 12 - 14 mm			
920/21	125 mm			
920/22	255 mm			
920/25				
920/42				
920/55				
	420x280x60 mm - 6,7 kg			

920A/C17M - 920A/C17MR

Coffret métallique avec plateau en mousse compacte comprenant 1 cliquet avec 17 douilles 6 pans et 4 accessoires

12"



920A/C17M CHF 404.00 1 009200924

920A	10-11-12-13-14-15-16-17-18-19-20-21-22-24-27-30-32 mm
920/21	125 mm
920/22	255 mm
920/25	
920/42	305 mm
920/55	

420x185x60 mm - 5 kg

9899 920C17 30.00 1 098990137
Module souple vide

920A/C17MR CHF 443.00 1 009200937

920/21	125 mm
920/22	255 mm
920/25	
920/42	305 mm
920/58	

420x185x60 mm 5,1 kg

920/C37

37 douilles 12 pans et 5 accessoires

12"



920/C37 CHF 661.00 1 009200988

920B	10 - 11 - 12 - 13 - 14 - 15 - 16 - 17 - 18 - 19 - 20 - 21 - 22 - 23 - 24 - 26 - 27 - 28 - 30 - 32 mm
920AS	3/8 - 7/16 - 1/2 - 9/16 - 19/32 - 5/8 - 11/16 - 3/4 - 25/32 - 13/16 - 7/8 - 15/16 - 1 - 1.1/16 - 1.1/8 - 1.3/16 - 1.1/4
920/21	125 mm
920/22	255 mm
920/25	
920/42	
920/55	

420x280x60 mm - 7,5 kg

920AS/C10

10 douilles 12 pans et 2 accessoires

12"



920AS/C10 CHF 252.00 1 009200919

920AS	3/8 - 7/16 - 1/2 - 9/16 - 5/8 - 11/16 - 3/4 - 13/16 - 7/8 - 15/16
920/22	255 mm
920/50	

335x145x60 mm - 2,6 kg

920AS/C15

15 douilles 12 pans et 6 accessoires

12"



920AS/C15 CHF 471.00 1 009200947

920AS	3/8 - 7/16 - 1/2 - 9/16 - 5/8 - 11/16 - 3/4 - 13/16 - 7/8 - 15/16 - 1 - 1.1/16 - 1.1/8 - 1.3/16 - 1.1/4
920/21	125 mm
920/22	255 mm
920/25	
920/42	
920/46	
920/50	

420x280x60 mm - 5,9 kg

Beta

920AS/C17X

17 douilles 12 pans et 5 accessoires

12"



920AS/C17X CHF 439.00 1 009200942

920AS	3/8 - 7/16 - 1/2 - 9/16 - 19/32 - 5/8 - 11/16 - 3/4 - 25/32 - 13/16 - 7/8 - 15/16 - 1 - 1.1/16 - 1.1/8 - 1.3/16 - 1.1/4
920/21	125 mm
920/22	255 mm
920/25	
920/42	
920/55	

420x185x60 mm - 4,8 kg

920AS/MBM-C21

16 douilles 12 pans et 5 accessoires pour maintenance aéronautique

12"



920AS/MBM-C21 CHF 448.00 1 009200944

920AS	3/8 - 7/16 - 1/2 - 9/16 - 19/32 - 5/8 - 11/16 - 3/4 - 25/32 - 13/16 - 7/8 - 15/16 - 1 - 1.1/16 - 1.3/16 - 1.1/4
920M/55	
920/21	125 mm
920/22	255 mm
920/25	
920/42	

420x185x60 mm - 5,0 kg

Beta

920TX/C17

Coffret spécial Torx®

12"



920TX/C17 CHF 412.00 1 009200989

- 861TX T8 - T10 - T15 - T20 - T25 - T27
 - 897
 - 920TX T27 - T30 - T40 - T45 - T50
 - 920FTX E10 - E12 - E14 - E16 - E18 - E20
 - 920/20 75 mm
 - 920/22 255 mm
 - 920/55
- 420x185x60 mm - 2,9 kg

920A/C17HR

Coffret métallique avec plateau thermoformé rigide comprenant 1 cliquet avec 17 douilles 6 pans et 5 accessoires

• cliquet avec branche rotative

12"



920A/C17HR CHF 453.00 1 009200939

- 920A 10-11-12-13-14-15-16-17-18-19-20-21-22-24-27-30-32 mm
 - 920/21 125 mm
 - 920/22 255 mm
 - 920/25
 - 920/42
 - 920/58
- 420x185x60 mm - 5,1 kg

920U/C17M

Coffret 1/2 composé de 17 douilles multi empreintes et 5 accessoires, dans un plateau en mousse

12"



920U/C17M CHF 413.00 1 009201797

- 920U ○ 10-11-12-13-14-15-16-17-18-19-20-21-22-24-27-30-32 mm
* 3/8-7/16-15/32-1/2-9/16-19/32-5/8-3/4-25/32-7/8-15/16-1.1/16-1.1/8-1.1/4
○ M12-M14-M16-M18
○ E12-E14-E16-E18-E20-E22-E24
 - 920/21 125 mm
 - 920/22 255 mm
 - 920/25
 - 920/42 305 mm
 - 920/55 275 mm
- 420x185x60 mm - 5 kg

9899 920C17 CHF 30.00 1 098990137
Module souple vide

928A

Douille 6 pans

3/4"



UNI/ISO 2725
DIN 3124

mm	Ø mm	L mm	Ø1 mm	CHF	U	IT
19	29,2	50	34	20.70	5	009280019
21	30,0	51	34	21.10	5	009280021
22	31,3	53	34	21.10	5	009280022
23	33,3	53	34	21.50	5	009280023
24	34,5	53	34	21.80	5	009280024
26	36,8	55	35	23.30	5	009280026
27	38,0	56	35	23.30	5	009280027
28	39,0	57	35	24.80	3	009280028
29	40,2	58	35	25.50	3	009280029
30	41,5	58	37	26.00	3	009280030
32	44,3	60	37	27.00	3	009280032
33	45,8	60	37	28.00	3	009280033
34	46,8	60	37	29.00	3	009280034
35	48,1	62	38	29.50	3	009280035
36	49,5	64	38	29.50	3	009280036
38	52,0	68	40	32.00	3	009280038
41	56,0	71	40	36.00	3	009280041
46	62,3	75	43	44.00	3	009280046
50	67,4	80	43	53.50	3	009280050
55	73,7	84	48	65.50	1	009280055
60	80,0	87	48	75.50	1	009280060

928B

Douille 12 pans

3/4"



UNI/ISO 2725
DIN 3124

mm	Ø mm	L mm	Ø1 mm	CHF	U	IT
19	29,2	50	34	20.70	5	009280119
21	30,0	51	34	21.10	5	009280121
22	31,3	53	34	21.10	5	009280122
23	33,3	53	34	21.50	5	009280123
24	34,5	53	34	21.80	5	009280124
26	36,8	55	35	23.30	5	009280126
27	38,0	56	35	23.30	5	009280127
28	39,0	57	35	24.80	3	009280128
29	40,2	58	35	25.50	3	009280129
30	41,5	58	37	26.00	3	009280130
32	44,3	60	37	27.00	3	009280132
33	45,8	60	37	28.00	3	009280133
34	46,8	60	37	29.00	3	009280134
35	48,1	62	38	29.50	3	009280135
36	49,5	64	38	29.50	3	009280136
38	52,0	68	40	32.00	3	009280138
41	56,0	71	40	36.00	3	009280141
46	62,3	75	43	44.00	3	009280146
50	67,4	80	43	53.50	3	009280150
55	73,7	84	48	65.50	1	009280155
60	80,0	87	48	75.50	1	009280160

928AS

Douille 6 pans

3/4"



"	Ø mm	L mm	Ø1 mm	CHF	U	IT
7/8	32,0	53	34	23.80	1	009280202
15/16	34,5	53	34	23.80	1	009280203
1	36,2	55	35	25.00	1	009280204
1.1/16	38,0	56	35	26.00	1	009280205
1.1/8	40,2	58	35	26.50	1	009280206
1.1/4	44,2	60	37	29.00	1	009280208
1.5/16	45,8	60	37	30.00	1	009280209
1.3/8	48,1	62	38	31.50	1	009280210
1.7/16	49,5	64	38	33.00	1	009280211
1.1/2	52,0	68	40	36.00	1	009280212
1.5/8	56,0	71	40	39.00	1	009280214
1.11/16	58,8	74	40	44.50	1	009280215
1.13/16	62,3	75	43	50.00	1	009280217
1.7/8	65,0	78	43	54.00	1	009280218
2	68,3	80	43	62.00	1	009280219
2.1/16	71,5	83	48	72.00	1	009280220

928ME

Douille tournevis pour vis 6 pans creux

3/4"



mm	Ø mm	L mm	L1 mm	CHF	U	IT
14	35	75	15,5	48.50	2	009280514
17	35	75	15,5	48.50	2	009280517
19	35	75	15,5	48.50	2	009280519
22	35	75	22,5	48.50	2	009280522

928/15

Réducteur carré femelle 3/4" et mâle 1/2"



UNI/ISO 3316
DIN 3123

L mm	Ø mm	3/4"	1/2"	CHF	5	009280801
51,5	34			25.00		



Toujours appliquer la force de serrage régulièrement et progressivement afin d'éviter la rupture et de se protéger contre un possible accident.

928/16

Augmentateur carré femelle 3/4" et mâle 1"



UNI/ISO 3316
DIN 3123

L mm	Ø mm	3/4"	1"	CHF	5	009280807
65	34			30.00		

928/20 - 928/21 - 928/22

Rallonge carrés mâle et femelle 3/4"



UNI/ISO 3316
DIN 3123

	L mm	Ø mm	CHF	3	009280810
928/20	100	34	29.50		
928/21	200	34	39.50		
928/22	380	34	58.00		

928/25

Cardan carrés mâle et femelle 3/4"



UNI/ISO 3316 DIN 3123

L mm	Ø mm	CHF	1	009280830
108	40	100.00		

928/36A

Poignée articulée carré mâle 3/4"



DIN 3122 - UNI ISO 3315

L mm	CHF	1	009280844
545	119.50		

928/42

Poignée coulissante carré mâle 3/4"

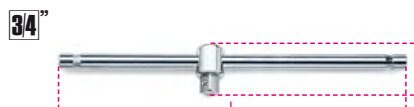

UNI/ISO 3315 DIN 3122

L mm	A mm	CHF	3	009280850
450	62,5	63.00		

928/55

Cliquet réversible carré mâle 3/4" à 72 dents



DIN 3122 - UNI ISO 3315

L mm	Ø mm	A mm	CHF	2	009280862
510	58	59	202.50		

Voir le tableau après la ref. 928/C8 pour les pièces détachées du mécanisme de la tête de la clé dynamométrique

928.../C12

Coffret métallique comprenant 1 cliquet avec 12 douilles 6 pans et 4 accessoires



928A/C12	CHF	1	009280955
928A	1,075.00		

	928A	22 - 24 - 27 - 30 - 32 - 34 - 36
	928/21	200 mm
	928/22	380 mm
	928/25	
	928/42	
	928/55	

530x220x80 mm - 13,5 kg

928B/C12	CHF	1	009280957
928B	1,075.00		

	928B	22 - 24 - 27 - 30 - 32 - 34 - 36
	928/21	200 mm
	928/22	380 mm
	928/25	
	928/42	
	928/55	

530x220x80 mm - 13,5 kg

928AS/C12

Coffret métallique comprenant 1 cliquet avec 12 douilles 6 pans et 5 accessoires



928AS/C12	CHF	1	009280968
928AS	1,115.00		

	928AS	7/8-15/16-1.1/16-1.1/8-1.1/4
	928/21	200 mm
	928/22	380 mm
	928/25	
	928/42	
	928/55	

530x220x80 mm - 13,5 kg

929

Douille 6 pans



UNI/ISO 2725 DIN 3124

Ø mm	Ø mm	L mm	Ø1 mm	CHF	1	009290036
36	51	65	48	44.00		
41	57	70	48	46.50		
46	65	75	48	52.00		
50	70	80	48	60.00		
55	76	85	54	70.50		
60	82	90	54	75.50		
65	88	95	54	97.50		
70	92	100	60	116.50		
75	99	110	60	126.50		
80	106	120	60	145.00		

929/15

Réducteur carré femelle 1" et mâle 3/4"

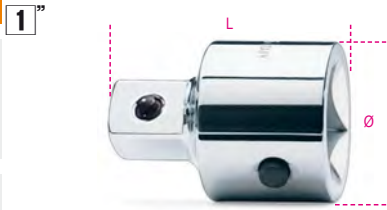

UNI/ISO 3316 DIN 3123

L mm	Ø mm	CHF	1	009290801
65	47	52.00		



Toujours appliquer la force de serrage régulièrement et progressivement afin d'éviter la rupture et de se protéger contre un possible accident.

929/21 - 929/22

Rallonge carrés mâle et femelle 1"



UNI/ISO 3316 DIN 3123

	L mm	Ø mm	CHF	1	009290815
929/21	200	47	67.00		
929/22	400	47	97.50		

929/42

Poignée coulissante carré mâle 1"



UNI/ISO 3315 DIN 3122

L mm	CHF	1	009290850
535	125.00		

929/55

Cliquet réversible carré mâle 1" à 72 dents



UNI/ISO 3315 DIN 3122

L mm	Ø mm	A mm	CHF	1	009290860
770	62	63	270.00		

929/55PR

Rallonge pour cliquets 929/55



L mm	Ø mm	Ø1 mm	CHF	1	009290868
540	32	26	57.50		

929/C8

8 douilles 6 pans et 5 accessoires



929/C8	CHF	1	009290925
	1,575.00		

○ 929	46 - 50 - 55 - 60 - 65 70 - 75 - 80 mm
929/15	□ 1" - ■ 3/4"
929/21	200 mm
929/22	400 mm
929/42	
929/55	

560x290x120 mm - 29 kg

9899 CV/A

coffret vide



9899 CV/A	CHF	1	098990001
	42.50		

583/C31-671B/C5-671B/C10-720ME/C8-860/C38P
861/C61P-900/C11-900AS/C10-/MB-C17-900/C24
900/C13-8-900/C13-5-900MB/C19-900MB/C28
900/C11HR-900AS/C10-/MB-C17-900AS/C17
MBM-900/C11Z-900MC/C24-900MC/C32-910.../C10
971/C8-920TX/C-920PE/C-920FTX/C-910.../C10

270x120x45 mm

9899 CV/B

coffret vide



9899 CV/B	CHF	1	098990002
	49.50		

352C/U-720MC/C13-727/C16-867/C20
900/C12MR-900/C12MZ-900U/C12M-910AS/C13...
910AS/MBM-C18-910A/C16...-910B/C16...
910A/C16HR-910A/C16...-910B/C16...-920AS/C10
920.../C11-1433/C11-1494/C14A-1529-1545/C5M

335x145x60 mm

9899 CV/C

coffret vide



9899 CV/C	CHF	1	098990003
	60.50		

920A/C17HR-920A/C17MR-920.../C12...
920A/C17M-910.../C29-902A/C22-867/C38
720/C24-450/C15-353N/C6-960KPC-920MC/C14
920U/C17M-920TX/C17-920.../C20...-920AS/MBM
C21-920AS/C17X-1547/C6-1495/C6-1489/C14
1461/C11A-1608/C9-1606A/C9-1602/C9

420x185x60 mm

900/R55



900/R55	CHF	1	009000871
	44.00		

666N/2-900/55-666/2

900/R55-Z



900/R55-Z	CHF	1	009000872
	44.00		

900M/R55



900M/R55	CHF	1	009000888
	23.10		

900M/55

910/R55



910/R55
 599DGT/6-606/6-606/10-612
 665/6-665/10-665LB/6-665LB/10
 666N/5-666N/10-666N LBF.IN/5-
 666N LBF.IN/10
 666/6-666/10-668RGC/6-
 668RGC/10-910/55
 666/5-666HS/5-666HS/10-666 LBF.FT/2
 666 LBF.FT/5-666 LBF.FT/10

CHF 42.50 1 009100879

910M/R55



910M/R55
 910M/55-910M/56

CHF 23.80 1 009100888

910/R55Q



910/R55Q
 910/55Q

CHF 42.50 1 009100877

910/R55X



910/R55X
 666N/2X-666/2X-666 LBF.FT/2X

CHF 42.50 1 009100897

920/R50



920/R50
 614/50-667/20-667/30
 667N/20-667N/30-920/50

CHF 42.00 1 009200866

920/R55



920/R55
 606/20-606/30-666/20-666/30-920/55
 920/56A- 599DGT/20-599DGT/30
 599DGT-AN/20-665/20-665/30-665LB/20
 665LB/30-666N/20-666N/30
 666N LBF.IN/20-666N LBF.IN/30-668RGC/20
 666 LBF.FT/20-666 LBF.FT/30

CHF 51.50 1 009200879

920M/R55



920M/R55
 920M/55-920M/56

CHF 26.50 1 009200888

920/R55Q



920/R55Q
 920/55Q

CHF 51.50 1 009200877

920/R55X



920/R55X
 606/10X-612X
 666/10X-920/55X-599DGT/10X-599DGT-
 AN/10
 665/10X-665LB/10X-666N10X-
 666N LBF.IN/10X
 668RGC/10X-666 LBF.FT/10X
 666HS/20LC-666HS/30LC

CHF 42.00 1 009200878

920/R55LC



920/R55LC
 920/55LC "Locking System"

CHF 54.00 1 009200887

928/R55



928/R55
 928/55

CHF 85.50 1 009280859

928/R55X



928/R55X
 614X

CHF 54.50 1 009280858

929/R55



929/R55
 929/55

CHF 98.50 1 009290859

930

Clé en tube droite 12 pans gros effort



UNI 6745

mm	L	Ø	Ø1	CHF	
6x7	100	9,5	11,0	17.20	3 009300006
8x9	108	12,5	14,0	21.70	3 009300010
10x11	116	15,0	16,5	22.70	3 009300014
12x13	124	17,5	19,0	26.50	3 009300018
14x15	132	20,0	21,5	29.00	3 009300023
16x17	140	23,0	24,0	33.50	3 009300027
18x19	148	25,0	26,5	37.00	3 009300032
20x22	156	28,0	30,0	41.00	2 009300036
21x23	163	29,0	31,5	43.50	2 009300040
24x26	173	33,0	35,5	55.00	2 009300044
25x28	182	34,5	38,0	59.50	2 009300048
27x29	191	37,0	39,5	68.00	2 009300052
30x32	200	40,5	43,0	82.50	2 009300056



930/S8
 6x7-8x9-10x11
 12x13-14x15-16x17
 18x19-20x22 mm

CHF 246.00 1 009300081

940/1 - /2
930/S13
 6x7-8x9-10x11-12x13
 14x15-16x17-18x19
 20x22-21x23-24x26
 25x28-27x29-30x32 mm

573.00 1 009300083

940/1 - /2 - /3



930/C13
 6x7-8x9-10x11-12x13
 14x15-16x17-18x19
 20x22-21x23-24x26
 25x28-27x29-30x32 mm

CHF 640.00 1 009300098

940/1 - /2 - /3

932

Clé à pipe débouchée chromée polie

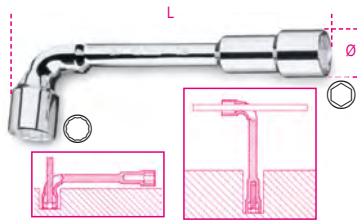

NF E 74.303

mm	Ø mm	L mm	CHF	🔧	📄
6x6	11,5	110	19.40	5	009320006
7x7	12,5	116	19.60	5	009320007
8x8	13,0	120	20.30	5	009320008
9x9	14,0	125	21.10	5	009320009
10x10	16,5	133	22.00	5	009320010
11x11	17,5	143	23.90	5	009320011
12x12	19,0	148	25.50	5	009320012
13x13	19,5	154	26.50	5	009320013
14x14	21,5	167	28.00	5	009320014
15x15	22,5	182	29.50	5	009320015
16x16	24,5	193	30.50	5	009320016
17x17	26,0	198	31.00	5	009320017
18x18	26,5	215	34.00	5	009320018
19x19	29,0	220	37.00	5	009320019
20x20	30,5	222	39.50	3	009320020
21x21	30,5	236	45.00	3	009320021
22x22	32,5	250	49.50	2	009320022
23x23	33,5	256	55.00	2	009320023
24x24	35,0	272	59.00	2	009320024
25x25	36,5	282	62.50	2	009320025
26x26	37,5	296	69.00	2	009320026
27x27	39,0	296	72.00	2	009320027
28x28	39,0	314	82.00	2	009320028
30x30	42,5	348	98.00	2	009320030
32x32	45,5	364	108.50	2	009320032



	CHF	🔧	📄
932/S11 6-7-8-10-11-12 13-14-17-19-22 mm	303.00	1	009320080
932/S17 6-7-8-9-10-11-12 13-14-15-16-17 18-19-20-21-22 mm	503.00	1	009320081
932/S25 6-7-8-9-10-11-12-13 14-15-16-17-18-19 20-21-22-23-24-25 26-27-28-30-32 mm	1,109.00	1	009320082

933

Clé à pipe débouchée chromée polie

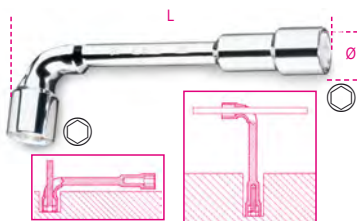

NF E 74.303

mm	Ø mm	L mm	CHF	🔧	📄
6x6	11,5	110	19.40	5	009330006
7x7	12,5	116	19.60	5	009330007
8x8	13,0	120	20.30	5	009330008

mm	Ø mm	L mm	CHF	🔧	📄
9x9	14,0	125	21.10	5	009330009
10x10	16,5	133	22.00	5	009330010
11x11	17,5	143	23.90	5	009330011
12x12	19,0	148	25.50	5	009330012
13x13	19,5	154	26.50	5	009330013
14x14	21,5	167	28.00	5	009330014
15x15	22,5	182	29.50	5	009330015
16x16	24,5	193	30.50	5	009330016
17x17	26,0	198	31.00	5	009330017
18x18	26,5	215	34.00	5	009330018
19x19	29,0	220	37.00	5	009330019
20x20	30,5	222	39.50	3	009330020
21x21	30,5	236	45.00	3	009330021
22x22	32,5	250	49.50	2	009330022
23x23	33,5	256	55.00	2	009330023
24x24	35,0	272	59.00	2	009330024
25x25	36,5	282	62.50	2	009330025
26x26	37,5	296	69.00	2	009330026
27x27	39,0	296	72.00	2	009330027
28x28	39,0	314	82.00	2	009330028
30x30	42,5	348	98.00	2	009330030
32x32	45,5	364	108.50	2	009330032



	CHF	🔧	📄
933/S11 6-7-8-10-11-12 13-14-17-19-22 mm	303.00	1	009330080
933/S17 6-7-8-9-10-11-12 13-14-15-16-17 18-19-20-21-22 mm	503.00	1	009330081
933/S25 6-7-8-9-10-11-12-13 14-15-16-17-18-19 20-21-22-23-24-25 26-27-28-30-32 mm	1,109.00	1	009330082

935

Clé en tube droite 6 pans, série légère



UNI 6746 DIN 896

mm	L mm	CHF	🔧	📄
6x7	100	10.00	5	009350105
8x9	110	10.70	5	009350111
10x11	120	12.00	5	009350115
12x13	130	13.50	5	009350117
14x15	140	15.80	5	009350126
16x17	150	17.20	5	009350128
18x19	160	20.30	5	009350131
20x22	170	24.70	3	009350138
21x23	180	27.50	3	009350141
24x26	190	31.00	3	009350144
25x28	200	34.00	2	009350150
27x29	210	40.50	2	009350153
30x32	220	43.50	2	009350156

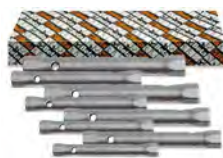

	CHF	🔧	📄
935/S8 6x7-8x9-10x11 12x13-14x15-16x17 18x19-20x22 mm	141.50	1	009350181
940/1 - /2			
935/S13 6x7-8x9-10x11 12x13-14x15-16x17 18x19-20x22-21x23 24x26-25x28-27x29 30x32 mm	335.00	1	009350183
940/1 - /2 - /3			

937

Clé à pipe débouchée chromée

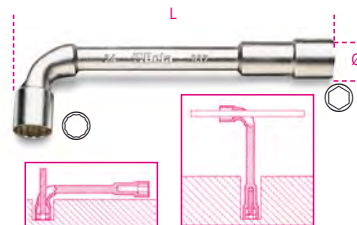

mm	Ø mm	L mm	CHF	🔧	📄
6x6	11,5	110	10.70	5	009370006
7x7	12,5	116	11.20	5	009370007
8x8	13,0	120	11.60	5	009370008
9x9	14,0	125	12.30	5	009370009
10x10	16,5	133	12.90	5	009370010
11x11	17,5	143	13.50	5	009370011
12x12	19,0	148	15.10	5	009370012
13x13	19,5	154	15.50	5	009370013
14x14	21,5	167	17.00	5	009370014
15x15	22,5	182	18.70	5	009370015
16x16	24,5	193	20.20	5	009370016
17x17	26,0	198	21.00	5	009370017
18x18	26,5	215	21.50	5	009370018
19x19	29,0	220	22.30	5	009370019
20x20	30,5	222	25.50	3	009370020
21x21	30,5	236	27.50	3	009370021
22x22	32,5	250	29.00	2	009370022
23x23	33,5	256	32.00	2	009370023
24x24	35,0	272	33.50	2	009370024
25x25	36,5	282	42.50	2	009370025
26x26	37,5	296	44.00	2	009370026
27x27	39,0	296	44.50	2	009370027
28x28	39,0	314	54.00	2	009370028
30x30	42,5	348	57.50	2	009370030
32x32	45,5	364	65.00	2	009370032



	CHF	🔧	📄
937/S11 6-7-8-10-11-12 13-14-17-19-22 mm	180.00	1	009370080
937/S17 6-7-8-9-10-11-12 13-14-15-16-17 18-19-20-21-22 mm	306.00	1	009370081

940

Broche pour 930-935



	mm	L mm	CHF	🔧	📄
940/1	6+13	100	7.45	5	009400001
940/2	14+22	170	9.75	5	009400002
940/3	21+32	290	17.60	5	009400003

941

Clé à douilles à poignée en T haute performance

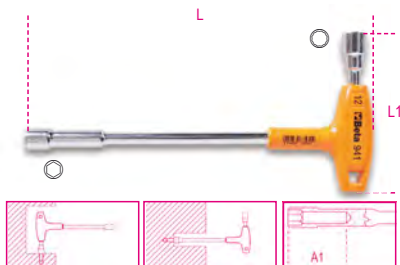

mm	L mm	L1 mm	A1 mm	CHF		
7x7	200	91	35	36.00	2	009410107
8x8	220	107	50	39.50	2	009410108
9x9	220	109	50	39.50	2	009410109
10x10	236	111	50	40.50	2	009410110
11x11	236	114	50	42.00	2	009410111
12x12	255	122	50	46.50	2	009410112
13x13	255	124	55	47.00	2	009410113



941/S7	CHF		
7-8-9-10-11-12-13 mm	291.00	1	009410170

CLÉS À DOUILLES EMMANCHÉES AVEC POIGNÉE

Convient aux opérations de vissage rapides et répétées. L'épaisseur réduite des douilles 6 pans permet d'accéder aux espaces exigus. Le trou d'échappement intérieur facilite le travail sur les écrous sur tige filetées. C'est le cas, en particulier, des clés à douilles emmanchée série longue 944BX.

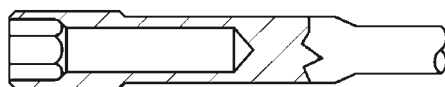

Le triple marquage sur la tête permet d'identifier plus facilement la taille souhaitée.

La lame flexible du modèle 943FL, qui est constituée d'acier protégé par une gaine, permet une transmission totale du couple en cas de décentrage avec la vis.

942BX

Clé à douille emmanchée, série courte



UNI 6750

mm	L mm	L1 mm	A1 mm	CHF		
4	190	70	13,0	18.00	5	009420003
5	190	70	14,0	18.00	5	009420004
5,5	190	70	12,5	20.30	5	009420005
6	190	70	14,5	20.30	5	009420006
7	190	70	15,5	21.30	5	009420007
8	202	70	18,5	21.30	5	009420008
9	202	70	19,5	21.30	5	009420009
10	202	70	20,5	22.70	3	009420010
11	202	70	21,5	22.70	3	009420011
12	202	70	22,5	22.70	3	009420012
13	202	70	23,5	25.50	3	009420013
14	202	70	24,5	25.50	3	009420014



942BX/S12	CHF		
4-5-5,5-6-7-8-9 10-11-12-13-14 mm	260.00	1	009420030

943BX

Clé à douille emmanchée, série longue



ISO 2236 UNI 6750

mm	L mm	L1 mm	A1 mm	CHF		
4	270	150	13,0	20.00	5	009430003
5	270	150	14,0	20.00	5	009430004
5,5	270	150	12,5	21.50	5	009430005
6	270	150	14,5	21.50	5	009430006
7	270	150	15,5	22.90	5	009430007
8	282	150	18,5	22.90	5	009430008
9	282	150	19,5	22.90	5	009430009
10	282	150	20,5	25.00	3	009430010
11	282	150	21,5	25.00	3	009430011
12	282	150	22,5	25.00	3	009430012
13	282	150	23,5	26.50	3	009430013
14	282	150	24,5	26.50	3	009430014



943BX/S12	CHF		
4-5-5,5-6-7-8-9 10-11-12-13-14 mm	280.00	1	009430030



943BX/D6	CHF		
5-6-7-8-10-13 mm	139.00	1	009430026

943FL

Clé à douille emmanchée flexible série longue



mm	L mm	L1 mm	Ø mm	CHF		
5	265	150	8	28.00	2	009430304
5,5	265	150	8	28.00	2	009430305
6	265	150	9	28.00	2	009430306
7	265	150	11	28.00	2	009430307
8	265	150	12	29.00	2	009430308
10	290	175	14	31.50	2	009430310



943FL/S6	CHF		
5-5,5-6-7-8-10 mm	173.50	1	009430320

Beta

944BX

Clé à douille emmanchée,
série longue



Betamax
MAXIMUM PERFORMANCE



ISO 2236 UNI 6750

mm	L mm	L1 mm	A1 mm	CHF	🔧	📦
4	245	125	20	20.70	3	009440003
5	245	125	25	20.70	3	009440004
5,5	245	125	30	25.50	3	009440005
6	245	125	35	25.50	3	009440006
7	245	125	35	25.50	3	009440007
8	257	125	50	27.00	3	009440008
9	257	125	50	27.00	3	009440009
10	257	125	50	28.50	3	009440010
11	257	125	50	28.50	3	009440011
12	257	125	50	31.00	3	009440012
13	257	125	55	31.00	3	009440013
14	257	125	55	31.00	3	009440014



CHF	🔧	📦
321.00	1	009440062

944BX/S12
4-5-5,5-6-7-8-9
10-11-12-13-14 mm

Betamax
MAXIMUM PERFORMANCE



CHF	🔧	📦
158.00	1	009440056

944BX/D6
5-6-7-8-10-13 mm

949

Clé à bécquille simple
avec douille profonde 6 pans

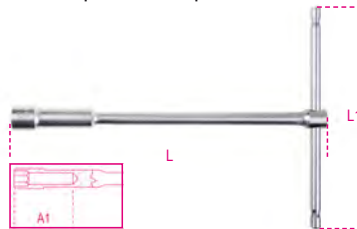

mm	L mm	L1 mm	A1 mm	CHF	🔧	📦
8	220	160	50	38.00	2	009490008
10	230	160	50	39.50	2	009490010
12	240	175	50	41.00	2	009490012
13	244	175	55	42.00	2	009490013
14	250	190	55	44.50	2	009490014
17	264	200	60	51.50	2	009490017



CHF	🔧	📦
257.00	1	009490076

949/S6
8-10-12-13-14-17mm

950

Clé à bécquille simple série longue

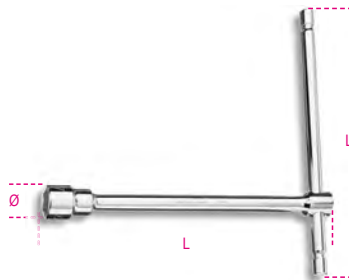

UNI 6742 DIN 3112

mm	L mm	Ø mm	L1 mm	CHF	🔧	📦
6	210	10,1	145	26.00	3	009500006
7	212	11,2	145	26.00	3	009500007
8	220	12,4	160	28.00	3	009500008
9	223	13,5	160	28.00	3	009500009
10	230	14,9	160	30.50	3	009500010
11	233	16,1	160	30.50	3	009500011
12	240	17,5	175	33.50	3	009500012
13	244	19,7	175	33.50	3	009500013
14	250	20,1	190	38.00	3	009500014
15	254	21,5	190	39.50	3	009500015
16	260	22,7	200	43.50	3	009500016
17	264	24,1	200	44.50	3	009500017
19	274	26,6	230	55.00	3	009500019
22	290	29,9	290	66.50	2	009500022
24	300	32,2	320	75.00	2	009500024
27	315	36,2	370	88.50	2	009500027



CHF	🔧	📦
320.00	1	009500079

950/S9
7-8-10-11-12
13-14-17-19 mm

CHF	🔧	📦
523.00	1	009500082

950/S14
6-7-8-9-10-11-12-13
14-15-16-17-19-22 mm

Beta

Beta

951 CLÉ EN T AVEC 3 EMBOUTS MALES



Lorsque cette clé a été lancée, en 1980, ce fut une révolution. Conçu pour fonctionner sur des vis à haute résistance, permettant une manipulation rapide, un ajustement précis et une utilisation polyvalente. La poignée hexagonale en T peut être ajustée selon les besoins. Les extrémités hexagonales sont conçues pour transmettre le couple maximal possible à la vis. La longueur de la tige permet d'appliquer sans effort des couples remarquables aux vis. Ses améliorations au fil des années se traduisent par son marquage laser, des finitions sablées, des extrémités hexagonales à arêtes vives permettant un meilleur ajustement sur toutes les vis, y compris celles endommagées.

951 Clé mâle 6 pans en T

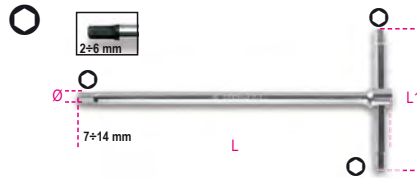

mm	L mm	L1 mm	Ø mm	CHF	🔧	📄
2	125	63	4,0	23.90	5	009510521
2,5	150	63	4,0	23.90	5	009510525
3	150	63	4,0	23.90	5	009510530
3,5	175	76	5,5	24.70	5	009510535
4	175	76	5,5	24.70	5	009510540
4,5	195	87	6,5	27.00	5	009510545
5	195	87	6,5	27.00	5	009510550
6	215	99	8,0	31.00	5	009510560
7	230	109	9,0	33.50	5	009510570
8	250	122	10,0	33.50	5	009510580
9	265	132	11,0	42.00	5	009510590
10	280	142	12,0	42.00	5	009510610
12	305	160	15,0	57.00	3	009510620
14	330	178	17,0	68.00	3	009510640

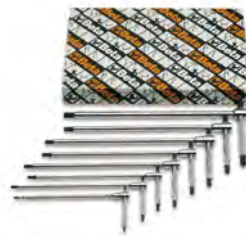

	CHF	🔧	📄
951/S6 2,5-3-4-5-6-8 mm	164.50	1	009510687
951/S8 2-2,5-3-3,5-4-4,5-5-6 mm	206.50	1	009510693
951/S14 2-2,5-3-3,5-4-4,5-5-6-7-8-9-10-12-14 mm	482.00	1	009510695



	CHF	🔧	📄
951/SP6 3-4-5-6-8-10 mm	207.00	1	009510696
951/SPV	38.50	1	009510697



951AS Clé mâle 6 pans en T

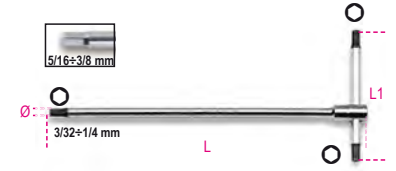

"	L mm	L1 mm	Ø mm	CHF	🔧	📄
3/32	125	63	4,0	32.00	2	009510750
7/64	150	63	4,0	32.00	2	009510751
1/8	150	63	4,0	32.00	2	009510752
9/64	175	76	5,5	33.50	2	009510753
5/32	175	76	5,5	33.50	2	009510754
3/16	195	86	6,5	36.50	2	009510755
7/32	215	99	8,0	36.50	2	009510757
1/4	230	109	9,0	41.50	2	009510758
5/16	250	122	10,0	42.00	2	009510759
3/8	280	142	12,0	51.50	2	009510760



	CHF	🔧	📄
951AS/S6X 1/8-3/16-7/32-1/4-5/16-3/8	240.50	1	009510771

951TX Clé mâle pour vis à empreinte Torx® en T



🔧	L mm	L1 mm	Ø mm	CHF	🔧	📄
T6	125	63	4	29.50	3	009510806
T7	125	63	4	29.50	3	009510807
T8	125	63	4	30.50	3	009510808
T9	125	63	4	30.50	3	009510809
T10	150	63	4	31.00	3	009510810
T15	150	63	4	31.00	3	009510815
T20	175	76	5	33.00	3	009510820
T25	175	76	5	33.00	3	009510825
T27	195	87	6	34.50	3	009510827
T30	195	87	6	34.50	3	009510830
T40	215	99	7	40.50	3	009510840
T45	230	109	8	42.50	3	009510845
T50	250	122	9	46.00	3	009510850



	CHF	🔧	📄
951TX/S6 T8-T10-T15-T20-T25-T30	193.00	1	009510866
951TX/S13 T6-T7-T8-T9-T10-T15-T20-T25-T27-T30-T40-T45-T50	446.00	1	009510863

952 CLÉ EN T À DOUILLE À CARDAN

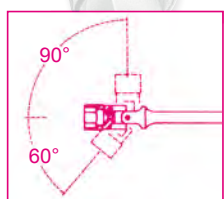

Un pré-positionnement fiable et précis est le secret du succès de cette clé. Le joint articulé conserve sa fonction au fil des années, aucun réglage n'étant nécessaire. Angle de rotation de la douille : 60°. Utilisable à 90° en position fixe. Poignée en T coulissante, peut être arrêtée dans la position requise sur toute sa longueur. Marquage triple taille sur la tête.

952 Clé à bécuille à cardan

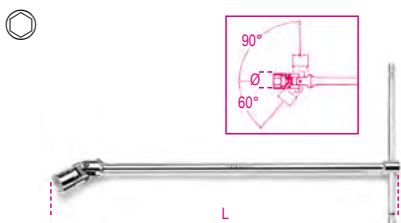

UNI 6743

mm	Ø mm	L mm	CHF	🔧	📦
6	9,5	395	40.50	5	009520006
7	10,7	395	40.50	5	009520007
8	12,1	395	40.50	5	009520008
9	13,2	395	40.50	5	009520009
10	14,6	400	43.50	5	009520010
11	15,8	400	43.50	5	009520011
12	17,0	400	43.50	5	009520012
13	18,7	432	46.50	5	009520013
14	19,7	432	46.50	5	009520014
15	20,9	450	57.00	3	009520015
16	22,0	450	57.00	3	009520016
17	23,4	450	57.00	3	009520017
18	24,7	450	57.00	3	009520018
19	26,0	500	69.50	3	009520019
20	27,4	500	69.50	3	009520020
21	28,5	500	69.50	3	009520021
22	29,7	500	69.50	3	009520022
24	32,4	500	69.50	3	009520024



	CHF	🔧	📦
952/S7 8-10-11-13-14-17-19 mm	346.00	1	009520074
952/S10 7-8-10-11-12-13-14-15-17-19 mm	487.00	1	009520080
952/S18 6-7-8-9-10-11-12-13-14-15-16-17-18-19-20-21-22-24 mm	960.00	1	009520083

852



852

78,84



952AS Clé à bécuille à cardan

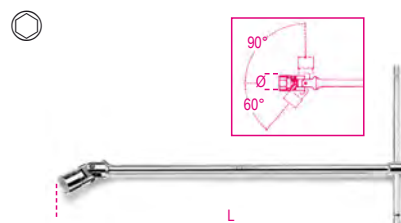

mm	Ø mm	L mm	CHF	🔧	📦
1/4	9,5	395	44.00	2	009520256
5/16	12,1	395	44.00	2	009520258
3/8	14,6	400	47.00	2	009520260
7/16	15,8	400	47.00	2	009520261
1/2	18,7	432	53.50	2	009520263
9/16	19,7	432	57.00	2	009520264
5/8	22,0	450	60.50	2	009520266
11/16	23,4	450	60.50	2	009520267
3/4	26,0	500	75.50	2	009520269

952L

Clé à bécuille à cardan série longue

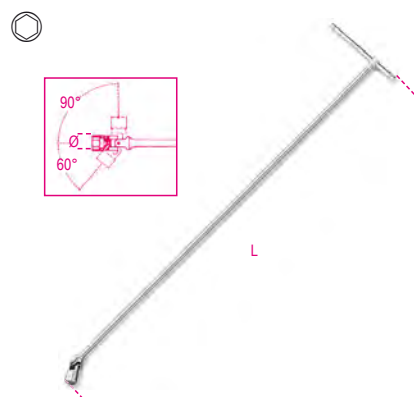

mm	Ø mm	L mm	CHF	🔧	📦
10	14,6	930	110.50	1	009520410
12	17,0	1063	110.50	1	009520412
13	18,7	1100	110.50	1	009520413
14	19,7	1100	110.50	1	009520414
15	20,9	1100	124.00	1	009520415
16	22,0	1100	124.00	1	009520416
17	23,4	1100	124.00	1	009520417
18	24,7	1100	124.00	1	009520418
19	26,0	1100	144.00	1	009520419

952FTX

Clé à bécuille à cardan pour écrou TORX®

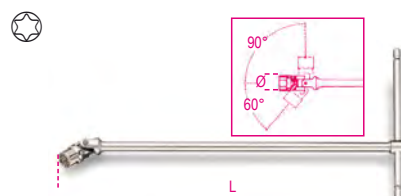

mm	Ø mm	L mm	CHF	🔧	📦
E6	8	392	47.00	2	009520106
E7	9	392	47.00	2	009520107
E8	10	395	54.50	2	009520108
E10	13	400	56.00	2	009520110
E12	15	440	67.00	2	009520112
E14	17	490	82.00	2	009520114
E16	19	490	82.00	2	009520116
E18	21	490	82.00	2	009520118
E20	23	490	82.00	2	009520120



952FTX/S9 CHF 599.00 1 009520141
E6-E7-E8-E10-E12
E14-E16-E18-E20

953

Clé mâle 6 pans à béquille à cardan

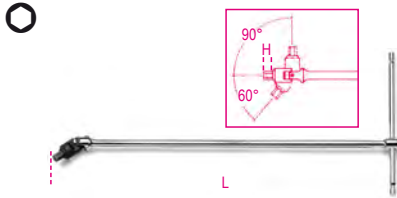

UNI 6754

mm	H mm	L mm	CHF		
3	5	395	41.50	5	009530130
3,5	6	395	41.50	3	009530135
4	6	395	41.50	5	009530140
4,5	7	395	41.50	3	009530145
5	7	395	41.50	5	009530150
6	9	400	44.50	5	009530160
7	10	425	49.50	3	009530170
8	11	425	49.50	5	009530180
10	13	440	59.00	5	009530200



953/S5 CHF 219.00 1 009530305
3-4-5-6-8 mm
953/S9 CHF 410.00 1 009530301
3-3,5-4-4,5
5-6-7-8-10 mm

953TX

Clé mâle à béquille à cardan pour vis TORX®

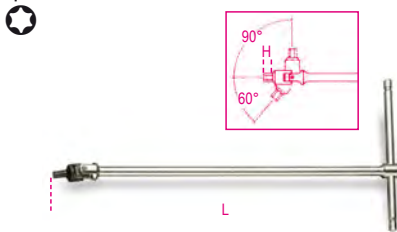

Ø	H mm	L mm	CHF		
T20	11	396	51.00	2	009530020
T25	11	396	51.00	2	009530025
T27	11	396	51.00	2	009530027
T30	13	400	56.00	2	009530030
T40	13	400	56.00	2	009530040
T45	13	426	57.00	2	009530045
T50	14	442	67.00	2	009530050
T55	14	442	67.50	2	009530055



953TX/S8 CHF 455.00 1 009530060
T20-T25-T27-T30
T40-T45-T50-T55

REPARATION DE VEHICULES

Nos outils de réparation de véhicules qui sont utilisés par les professionnels les plus exigeants, sont développés et fabriqués pour répondre aux normes les plus élevées du monde, et régulièrement testés dans les conditions de fonctionnement les plus difficiles.

Depuis plus de 50 ans, nous travaillons fièrement et en collaboration les plus grands champions des sport mécaniques, nous aidant à améliorer continuellement nos produits et témoignant du niveau de qualité PREMIUM.

Les outils de réparations de véhicules se trouvent dans les sections:

Diagnostics	articles 1438 to 1499 articles 1758VT to 1760TMC
Moteur	articles 955 to 989A articles 1438 to 1499
Vidange	articles 1438 to 1499 articles 1877 to 1885
Système électrique	articles 1438 to 1499
Boosters de démarrage	articles 1498BC/12 to 1498/40A
Transmission	articles 1438 to 1499
Suspension	articles 1549 to 1569CP
Freins	articles 1438 to 1499
Roues	articles 955 to 989A
Carrosserie	articles 1302 to 1369 articles 1763 to 1767A
Autres équipements	articles 1878 to 3067
Levage	articles 3029/2T to 3067/70-13T



955

Clé à bougies en tube



mm -"	D mm	L mm	CHF		
16	21	86	20.30	3	009550016
5/8					
20,8	29	86	20.30	3	009550021
13/16					

956C

Douille à bougies



ISO 11168

mm -"	Ø mm	L mm	CHF		
14	18,8	70	38.00	3	009560008
9/16					
16	21,4	70	38.00	3	009560010
5/8					
17,8	23,6	70	38.00	3	009560011
11/16					
20,8	27,0	70	38.50	3	009560012
13/16					

956E

Douille à bougies



ISO 11168

mm -"	Ø mm	L mm	CHF		
14	18,8	70	41.50	3	009560018
9/16					
16	21,4	70	41.50	3	009560020
5/8					
17,8	23,6	70	41.50	3	009560021
11/16					
20,8	27,0	70	42.00	3	009560022
13/16					

956F

Douille à bougies



mm -"	Ø mm	L mm	CHF		
14	18,8	70	46.50	1	009560114
9/16					
16	20,5	70	57.50	1	009560116
5/8					

Beta

956L Douille 12 pans à bougies série longue



mm - "	∅ mm	L mm	CHF	🔧	📦
14	19,0	250	77.50	2	009560214
9/16					
16	21,0	250	80.00	2	009560216
5/8					
17,8	24,0	250	84.50	2	009560217
11/16					
20,8	27,0	250	86.00	2	009560221
13/16					

957 Clé à bougies à rotule

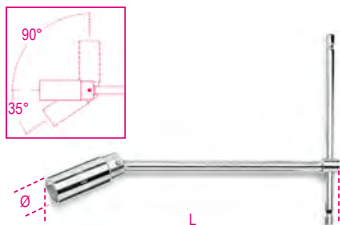

ISO 11168

mm - "	∅ mm	L mm	CHF	🔧	📦
16	21,4	275	58.00	3	009570000
5/8					
20,8	27,0	275	68.00	3	009570001
13/16					

959 Clé à bougies à cardan

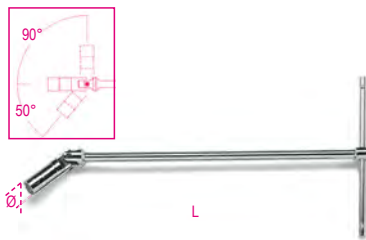

ISO 11168

mm - "	∅ mm	L mm	CHF	🔧	📦
14	18,8	483	67.50	3	009590009
9/16					
16	21,4	483	75.00	3	009590010
5/8					
20,8	27,0	527	100.50	3	009590011
13/16					

959R Capsule en caoutchouc et ressort de recharge pour 956C - 956E - 957 - 959

	CHF	🔧	📦
959R/14 956C/14-956E/14	6.95	3	009590223
959R/16 956C/16-956E/16 957/16-959/16	6.95	3	009590224
959R/17,8 956C/17,8-956E/17,8	6.95	3	009590225
959R/20,8 956C/20,8-956E/20,8 957/20,8-959/20,8-959L	6.95	3	009590226

960 Douille pour injecteurs Diesel



mm	∅ mm	L mm	CHF	🔧	📦
27	36,5	77	44.00	2	009600027

960A Douille pour injecteurs Diesel

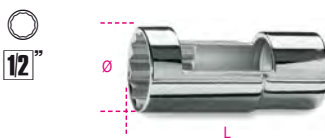

mm	∅ mm	L mm	CHF	🔧	📦
27	36,5	77	64.00	2	009600017

960BC/C5 coffret de 5 douilles pour injecteur

- définir le contenu:
- 1 douille hexagonale ouverte, 25 mm
 - 1 douille hexagonale ouverte, 27 mm
 - 1 douille hexagonale ouverte, 29 mm
 - 1 douille hexagonale ouverte, 30 mm
 - 1 douille bi-hexagonale, 28 mm



960BC/C5	CHF	🔧	📦
	197.00	1	009600280

280x160x55 mm - 1,9 kg

960BC Douille 6 pans ouvertes pour les connecteurs électriques des injecteurs



mm	CHF	🔧	📦
25	58.00	1	009600285
27	58.00	1	009600287
29	58.00	1	009600289
30	58.00	1	009600290

960BC/P 28 Douille 12 pans pour les connecteurs électriques des injecteurs



mm	CHF	🔧	📦
28	58.00	1	009600288

960BT/B Douille pour les connexions électriques des injecteurs

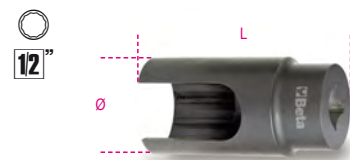

mm	∅ mm	L mm	CHF	🔧	📦
29	38,5	77	155.00	1	009600128

960ER

Extracteur de joint d'injecteur avec marteau à inertie

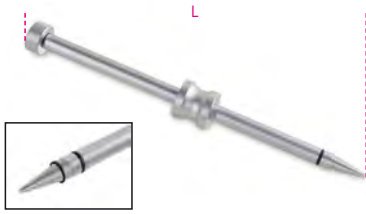

L mm	CHF		
350	78.50	1	009600726

960F

Douille à encoches pour écrous porte-injecteurs



Ø mm	Ø1 mm	●1 mm	●2 mm	CHF		
28,3	22	32	22	51.00	1	009600148

960G

Douille longue pour écrous à encoches pour poids-lourds Mercedes-Benz



Ø mm	Ø1 mm	● mm	L mm	CHF		
28,5	22	32	122	54.00	1	009600151

960L

Douille à encoches pour écrous porte-injecteurs



Ø mm	Ø1 mm	L mm	CHF		
30	22	122	58.00	1	009600153

960M

Douille à encoches pour écrous porte-injecteurs

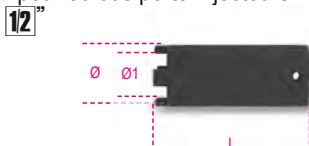

Ø mm	Ø1 mm	L mm	CHF		
28,5	22	72	42.50	1	009600154

960H/C4

Jeu de douilles à encoches pour écrous porte-injecteurs



960H/C4	CHF		
	153.00	1	009600152

960S

Douille pour injecteurs Diesel

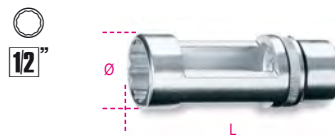

Ø mm	Ø mm	L mm	CHF		
22	30	82	49.50	1	009600022

960SL

Douille pour sonde Lambda

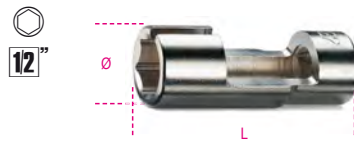

	Ø mm	CHF		
960SL85	33	76.00	2	009600085
	○ 22xL= 85 mm			
960SL110	33	87.00	2	009600110
	○ 22xL= 110 mm			

960SN

Douille à cardan pour bougies de préchauffage des moteurs diesel



Ø mm	Ø mm	□	L mm	CHF		
8	12,0	1/4	60	64.50	2	009600834
9	13,3	1/4	60	64.50	2	009600835
10	14,5	3/8	70	77.00	2	009600836
11	15,8	3/8	70	77.00	2	009600837
12	17,0	3/8	70	77.00	2	009600838

960T/C11

Jeu de douilles pour élimination/installation capteurs

Compris dans le kit :

- 1 douille 6 pans double mesure 1"-11/16" pour capteurs de pression huile
- 1 douille 6 pans ouverte 29 mm pour capteurs oxygène
- 1 douille 12 pans ouverte 27 mm pour injecteurs
- 1 douille 6 pans ouverte 22 mm pour vacuomètre
- 1 douille 6 pans ouverte 22 mm longueur 80 mm pour capteurs oxygène
- 1 douille 6 pans ouverte 22 mm longueur 90 mm pour capteurs oxygène
- 1 douille 6 pans ouverte 22 mm compacte longueur 30 mm pour capteurs oxygène
- 1 douille 6 pans ouverte 22 mm compacte longueur 50 mm pour capteurs oxygène
- 1 douille 6 pans et 12 pans ouverte 22 mm compacte longueur 34 mm, pour capteurs oxygène
- 1 douille 6 pans ouverte 22 mm avec géométrie à tube
- 1 taraud M18x1,5



○ 22 - 29 mm

960T/C11	CHF		
	253.00	1	009600031

≡ 330x270x25 mm

960T/A

Douille 6 pans ouverte 29 mm pour capteurs oxygène



Ø mm	L mm	CHF		
29	90	29.50	1	009600032

960T/B

Douille 13 pans ouverte 27 mm pour injecteurs

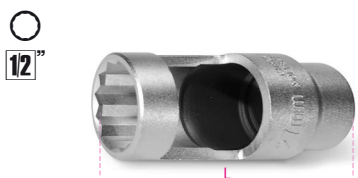

Ø mm	L mm	CHF		
27	85	26.00	1	009600033



960T/C

douille 6 pans ouverte 22 mm pour vacuomètre

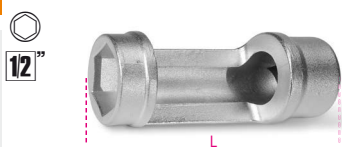

mm	L	CHF	
22	88	23.10	1 009600034

960T/D

Douille 6 pans ouverte 22 mm longueur 90 mm pour capteurs oxygène

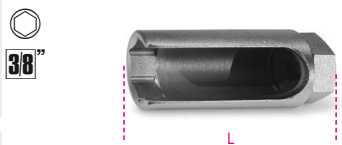

mm	mm	L	CHF	
22	25	90	21.00	1 009600035

960T/E

Douille 6 pans ouverte 22 mm longueur 80 mm pour capteurs oxygène

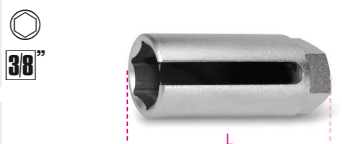

mm	mm	L	CHF	
22	25	80	19.20	1 009600036

960T/F

Douille 6 pans double mesure 1" - 1 1/16" pour capteurs de pression huile



"	mm	L	CHF	
1 - 1 1/16	28	74	18.10	1 009600037

960T/G

douille 6 pans ouverte 22 mm avec géométrie à tube



mm	mm	L	CHF	
22	25	98	51.50	1 009600038

960T/H

Douille 6 pans et 12 pans ouverte 22 mm compacte longueur 34 mm, pour capteurs oxygène

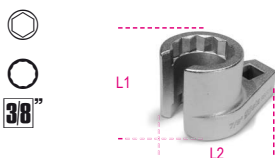

mm	L1	L2	CHF	
22	34	55	19.20	1 009600039

960T/I

douille 6 pans ouverte 22 mm compacte longueur 30 mm pour capteurs oxygène

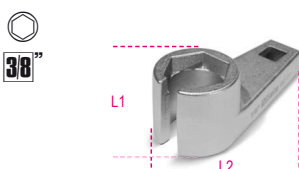

mm	L1	L2	CHF	
22	30	81	25.50	1 009600040

960T/L

douille 6 pans ouverte 22 mm compacte longueur 50 mm pour capteurs oxygène



mm	L1	L2	CHF	
22	50	58	19.50	1 009600041

960T/M

Taraud M18x1,5



mm	L	CHF	
21	50	6.45	1 009600042

960/22EP

Clé à chaîne à double empreinte pour sondes Lambda

Grande versatilité d'utilisation grâce à la double empreinte hexagonale/polygonale et à l'articulation à 180°



L	mm	mm	mm	CHF	
300	22	22	22	69.00	1 009600052

960/C6

Douille 6 pans avec carré femelle 3/8" pour retirer et/ou installer les capteurs de température de gaz d'échappement

Le kit comprend :

- 3 tailles en version courte 13, 14, 17 mm
- 3 tailles en version longue 13, 14, 17 mm



960/C6	CHF	
	106.50	1 009600055

170x120x50 mm

960/D

Clé 6 pans ouverte version longue pour retrait/installation capteurs de température gaz d'échappement



mm	CHF	
13	16.60	1 009600073
14	16.60	1 009600074
17	20.10	1 009600077

960YP

Clé 6 pans ouverte coudée pour retrait/installation capteurs de température de gaz d'échappement

38"



mm	CHF		
13	17.60	1	009600063
14	18.20	1	009600064
17	24.30	1	009600067

960AVE

Outil pour le contrôle des injecteurs électroniques Diesel Common Rail



Bar	CHF		
8÷40	341.00	1	009600245

≡ 430x310x50 mm - 2,0 kg

960CMB

Compressiomètre pour moteur à essence



Bar	CHF		
4÷17	806.00	1	009600250

≡ 440x370x100 mm - 2,2 kg

960CMB/R2

Carte de rechange pour 960CMB



Bar	CHF		
8÷40	41.50	1	009600252

960CMD

Compressiomètre pour moteur Diesel



Bar	CHF		
8÷40	894.00	1	009600270

≡ 440x370x100 mm - 2,4 kg

960CMD/R1

Carte de rechange pour 960CMD



Bar	CHF		
8÷40	41.50	1	009600271

960EPC

Jeu d'outils pour l'extraction de l'électrode des bougies de préchauffage

M8x1 - M9x1 - M10x1 - M10x1,25



Bar	CHF		
4÷17	821.00	1	009600790

≡ 270x230x80 mm - 900 g

960EPC/L

Jeu d'outils pour l'extraction de la pointe électrode des bougies de préchauffage

M8x1 - M9x1 - M10x1 - M10x1,25



Bar	CHF		
4÷17	1,120.00	1	009600890

≡ 270x230x80 mm - 2 kg

960E-PI/P

Extracteur de joints d'injecteurs

• Filet mâle M10 pour utilisation avec masse à inertie



Bar	CHF		
4÷17	88.00	1	009600706

≡ 300x90x60 mm

960KC-M8/M9/M10

Composition d'outils pour le démontage des bougies de préchauffage cassées ou endommagées

• Pour bougies avec filetage M8-M9-M10



Bar	CHF		
4÷17	567.00	1	009600801

≡ 380x290x50 mm - 2,3 kg

960KPC

Extracteur réversible à (vibration) "percussion"
à couple réglable
pour bougies de préchauffage
Couple réglable à 4 positions
10-20-30-40 Nm

1/4"
CE



960KPC
8-9-10-11-12 mm
420x185x60 mm - 2,8 kg
CHF 414.00
1 009600780

960UC

Composition d'outils pour l'extraction des
bougies bloquées
avec crayon déformé
M8-M9-M10



960UC
270x230x80 mm - 2,6 kg
CHF 650.00
1 009600900

960P

Testeur de contrôle pression/dépression
avec accessoires et adaptateurs



960P
350x320x95 mm - 1,9 kg
CHF 336.00
1 009600777

960PI

Composition d'alésoires pour le nettoyage
des sièges des injecteurs
en coffret plastique

Pour éliminer les résidus présents dans les sièges des
injecteurs

- Alésoir plat de Ø 19 - 15 mm pour injecteurs universels
- Alésoir plat de Ø 17 - 17 mm pour injecteurs Delphi/Bosch (BMW/PSA/Renault/Ford)
- Alésoir plat de Ø 19 - 17 mm pour injecteurs Bosch (Mercedes CDI).
- Alésoir d'angle de Ø 21 - 17 mm pour injecteurs Fiat/Iveco.
- Poignée



960PI
250x130x50 mm - 600 g
CHF 156.00
1 009600215

960PI/C19

Composition de 19 outils
pour le nettoyage des sièges des injecteurs

Compris dans le kit :

- 11 alésoirs plats de Ø:
14/14 mm - 15,5/15,5 mm - 15/19 mm - 17/19 mm - 17/17,5 mm
17/19 mm - 17/19,5 mm - 17/20 mm - 18/21 mm - 19 mm - 20/21 mm
- 4 alésoirs d'angle de Ø:
15,5/15,5 mm - 17/17 mm - 17,5/20,5 mm - 17/21 mm
- Poignée et accessoires pour l'utilisation des forets



960PI/C19
360x230x60 mm
CHF 392.00
1 009600217

960PI/S

Kit de nettoyage des sièges injecteurs

Compris dans le kit :

- 3 brosses en acier Ø 18, 22, 25 mm pour le nettoyage du siège des injecteurs
- 2 brosses Ø 14 et 16 mm pour le nettoyage du fond du siège des injecteurs
- 6 bouchons pour occlusion orifice de connexion chambre de combustion
- 1 écouvillon pour nettoyage orifice connexion chambre de combustion
- 1 porte-embouts flexible avec branche

1/4"



960PI/S
360x140x50 mm - 700 g
CHF 207.00
1 009600214

960VTC

Instrument de contrôle des
fuites des cylindres sur moteurs à essence

Suite à l'introduction d'air comprimé dans le cylindre, le
manomètre permet de vérifier la présence d'éventuelles fuites
de compression.



960VTC
373x295x70,6 mm - 2,3 kg
CHF 361.00
1 009600261

960RPI

Souffleur pneumatique pour le nettoyage des
conduits d'injecteurs

Pour moteurs avec bougies
M8x1 - M9x1 - M10x1 - M10x1.25



960RPI
CHF 250.00
1 009600940

960PMC

Pompe à tarer les injecteurs Diesel



Bar Max.
600
CHF 986.00
1 009600200

960AVL

Aspirateur de vapeur pour 960PMC



Bar Max.
6
CHF 1,111.00
1 009600210



961P6

Vidéoscope électronique
avec sonde flexible



CE

- Possibilité d'utiliser des Cartes SD (8 Go)
 - Supporte mémoires Flash (8 Go)
 - Mémoire interne de 128 Mo
 - Sortie TV-OUT
 - Supporte les formats vidéo (MP4, AVI, 3GP)
 - 4 Leds d'éclairage
 - Alimentation par prise USB (pile incorporée)
- CARACTÉRISTIQUES TECHNIQUES**
- Pixels du capteur : 640x480
 - Résolution maximum : 320x240
 - Longueur sonde : 1 m
 - Diamètre chambre : 6 mm
 - Formats vidéo : MPEG4, 3GP, AVI, ASF
 - Formats photos : JPEG
 - Angle de prise de vue : 0 ± 180°
 - Sortie données : câble USB et carte SD
 - Alimentation : pile 3,7 V - 2000 mAh

	CHF		
961P6	971.00	1	009610000

961P6/S

Sonde flexible, 6 mm



	L mm	CHF		
961P6/S1	1000	420.00	1	009610006
961P6/S2	2000	470.00	1	009610262
961P6/S3	3000	532.00	1	009610263

962

Levier démonte-pneus



L mm	A mm	CHF		
300	21	31.00	5	009620003
400	25	37.00	5	009620004
500	27	48.50	3	009620005
600	27	62.50	3	009620006

962C



962C	279
------	-----

962P

Levier démonte-pneus avec protection
en caoutchouc anti-rayures



L mm	A mm	CHF		
490	25	117.00	1	009620049

962M

Outil pour démontage/montage pneus

particulièrement indiqué pour Runflat et
modèles
avec épaules abaissées

- Mâchoires antirayures pour blocage sur jantes
- Siège pour installation levier démonte-pneus



962M	CHF 420.00	1	009620501
------	------------	---	-----------

963

Pince levier à broche et palette



L mm	A mm	CHF		
400	23	47.50	5	009630001



964

Pince levier à broche et à bec



L mm	A mm	CHF		
400	46	43.50	5	009640001

965

Levier plat coudé



L mm	A mm	L1 mm	CHF		
300	16	185	22.10	2	009650013
450	20	312	31.00	2	009650014
600	20	462	36.50	2	009650016



965/S3	CHF 90.00	1	009650019
--------	-----------	---	-----------

966/C3

Jeu de 3 leviers avec une tête articulée courbe



966/C3	CHF 165.50	1	009660103
--------	------------	---	-----------

L=200-250-300 mm

355x140x65 mm - 1,8 kg

720LS

Douille à chocs,
série longue et fine



	Ø mm	L mm	Ø1 mm	CHF		
720LS 36	36	48,0	78	78.00	2	007200386

969B

Douilles de serrage pour écrous de moyeux

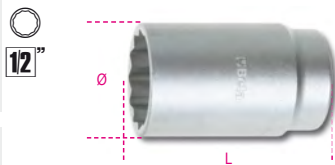

mm	Ø mm	L mm	CHF		
24	36,0	76	28.00	1	009690124
27	36,0	76	28.50	1	009690127
30	40,0	76	29.50	1	009690130
31	42,0	76	30.00	1	009690131
32	42,5	76	32.00	1	009690132
34	45,0	76	36.00	1	009690134
35	46,0	76	36.50	1	009690135
36	49,0	76	42.00	1	009690136

969/C5

Jeu de 5 douilles de serrage pour écrou de moyeu en coffret plastique



969/C5	CHF		
	176.00	1	009690201

969B 30-32-34-35-36

970B

Douille de serrage pour écrou de moyeu Fiat Daily

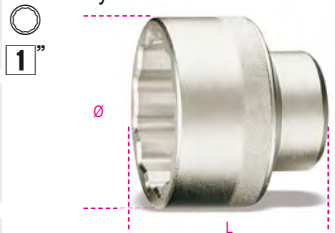

mm	Ø mm	L mm	CHF		
65	88	75	137.00	1	009700010

970IVECO

Douille à ergot pour écrous de moyeu Iveco Daily

Pour les versions à partir de l'année 2014

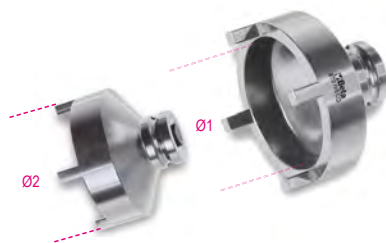

Ø1 mm	Ø2 mm	CHF		
61,5	74,8	82.50	1	009700011

971/C8

Kit d'intervention pour valves de roues pilotées TPMS



971/C8	CHF		
	527.00	1	009710108

	583/6	1,2+6 Nm
	892/0	
	862TX	T10-T15-T20
	900L	11-12 mm
	986 78	

972/C4BMW

Coffret de démontage d'écrous antivol BMW et Mini



972/C4BMW	CHF		
	301.00	1	009720004

516x145x66 mm - 3,8 kg

972/C10

coffret de démontage d'écrous antivol ou de roue endommagés

Pour une utilisation sur les écrous antivol et conventionnels



972/C10	CHF		
	379.00	1	009720010

290x250x60 mm - 2,4 kg

973

Kit de 4 housses de protection en nylon pour roues

Apte pour jantes de :
14" à 18" code 009730014
19" à 22" code 009730019



- conserve et protège la roue contre les éventuelles rayures et contre la poussière ;
- pendant le stockage, prévient la détérioration précoce des polymères du pneumatique d'été ou d'hiver ;
- au moyen d'une icône d'identification, permet de trouver aisément la position de la roue (avant droite/gauche ou arrière droite/gauche) ;
- dotées de poignée pour un transport aisé ;
- tissu : nylon, lavable.

973 14"+18"	CHF		
	132.50	1	009730014
973 19"+22"	147.00	1	009730019

978 - 979

Clé en croix pour écrous de roues

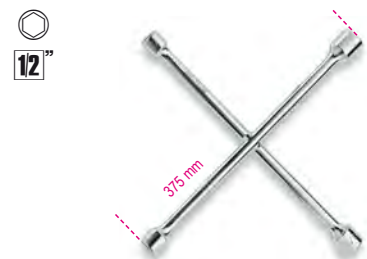

UNI/ISO 6788 DIN 3119

978	CHF		
17x19x21x22 mm	84.50	2	009780001
979	84.50	2	009790001
17x19x22x1/2 mm			

Beta

982

Clé en croix pour écrous de roues

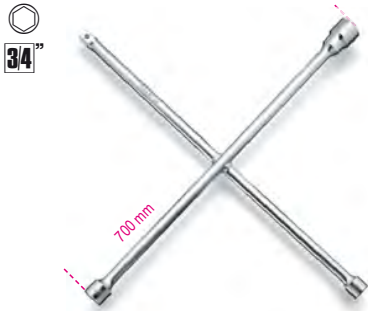

UNI/ISO 6788 DIN 3119

24x27x32x3/4 mm CHF 204.00 1 009820001

983PM

Brosse abrasive pour le nettoyage des moyeux



Ø1 90 mm, Ø2 150 mm CHF 98.50 1 009830010

983 PM/R-DA

Paire de disques abrasifs pour 983PM



Ø 150 mm CHF 91.00 1 009830050

984

Pince pour caches-écrous de roues



L 195 mm, H 4 mm CHF 33.50 1 009840005

985/B7

Assortiment de 7 pivots guide pour montage roues

Mesures comprises :

- M12x1,25 mâle
- M12x1,25 femelle
- M12x1,5 mâle
- M12x1,5 femelle
- M14x1,25 mâle
- M14x1,5 mâle
- M16x1,5 mâle



985/B7 CHF 131.00 1 009850007

985M

Pivot guide mâle pour montage roues



	L mm	CHF		
985M M12X1,25	150	17.00	1	009850101
985M M12X1,50	150	17.00	1	009850102
985M M14X1,25	150	17.60	1	009850103
985M M14X1,50	150	17.60	1	009850104
985M M16X1,50	150	19.40	1	009850105

985F

Pivot guide femelle pour montage roues



	L mm	CHF		
985F M12X1,25	150	22.70	1	009850106
985F M12X1,50	150	24.10	1	009850107



986 48

Tournevis pour valves pneus modèle court

Retenue automatique de la valve



L 18 mm, L1 48 mm CHF 19.40 1 009860048

986 78

Tournevis pour valves de pneus

Retenue automatique de la valve



L 18 mm, L1 78 mm CHF 19.40 1 009860078

986PT

Tournevis pré-étalonné 0,4 Nm pour vannes pneumatiques

Retenue automatique de la vanne

Le mécanisme de glissement permet de ne pas endommager le joint du centre de la vanne



L 19 mm, L1 120 mm CHF 67.50 1 009860140

987

Lever pour valves pneus avec protection en caoutchouc



L 310 mm CHF 39.50 1 009870001

987AR

Levier pour vannes pneumatiques avec centre anti-rayures

- Centre en caoutchouc et nylon pour jantes en alliage et en fer
- Branchement rapide de la vanne, ne nécessite pas de vissage



L mm 305 CHF 131.00 1 009870021

987P

Levier pour valves pneus en plastique

Tournevis dans le manche pour agir sur le mécanisme présent à l'intérieur de la valve



L mm 335 CHF 33.00 1 009870011

988/K4

Jeu de 4 burins en plastique anti-rayures



988/K4 CHF 34.50 1 009880104
A= 19-21-25-38 mm

989

Pince à masses d'équilibrage



L mm 250 CHF 62.50 2 009890001

989A

Pince pour retrait des plombs adhésifs équilibrage des roues



Profil des becs expressément étudié pour extraire les plombs sans contact avec la jante

989A L mm 220 CHF 42.50 1 009890011

989B

Pince pour masse d'équilibrage

les fonctions:

- suppression des poids adhésifs pour les jantes en alliage
- suppression des poids pour les jantes en fer
- marteau avec revêtement PE-HD amovible pour poids adhésifs et jantes en fer
- mâchoires de poids pour jantes en fer



L mm 230 CHF 81.00 1 009890015

990

Brucelles à becs droits pointes fines arrondies striées finition polie en acier inoxydable



L mm 130 CHF 15.50 5 009900001

991

Brucelles à becs coudés pointes fines arrondies striées finition polie en acier inoxydable



L mm 130 CHF 18.70 5 009910001

992

Brucelles à becs droits avec guide pointes fines arrondies striées finition polie en acier inoxydable



L mm 150 CHF 19.70 5 009920001

993

Brucelles à becs coudés avec guide pointes fines arrondies striées finition polie en acier inoxydable



L mm 145 CHF 21.10 5 009930001

993PL

Brucelles à becs coudés gainées PVC pointes fines arrondies striées finition polie en acier inoxydable



L mm 150 CHF 21.10 3 009930010

Beta

Beta

Quality Tools

993G

Brucelles à becs coudés avec guide pointes arrondies striées finition polie en acier inoxydable



L mm 160 CHF 19.40 3 009930030

994

Brucelles à becs droits arrondis pointes larges striées finition polie en acier inoxydable



L mm 150 CHF 16.10 5 009940001

994PL

Brucelles à becs droits arrondis gainées PVC pointes larges striées en acier inoxydable



L mm 150 CHF 19.40 3 009940010

994TF

Brucelles à becs droits arrondis résistant aux acides, antimagnétique pointes larges striées finition semi-polie en acier inoxydable



L mm 150 CHF 26.00 3 009940020

996

Brucelles à becs spatulés pointes droites lisses finition polie en acier inoxydable



L mm 150 CHF 17.10 5 009960001

998

Brucelles à becs droits auto-serrants, pointes larges becs croisés striés finition polie en acier inoxydable



L mm 155 CHF 29.50 5 009980001

999

Brucelles à becs plats arrondis résistant aux acides, antimagnétique pointes lisses finition semi-polie en acier inoxydable



L mm 115 CHF 23.40 3 009990011

999A

Brucelles à becs courts type aiguille résistant aux acides, antimagnétique pointes lisses finition semi-polie en acier inoxydable



L mm 120 CHF 20.30 3 009990015

999B

Brucelles à becs droits puissants résistant aux acides, antimagnétique pointes lisses finition semi-polie en acier inoxydable



L mm 120 CHF 20.70 3 009990017

999C

Brucelles à becs droits type aiguille résistant aux acides, antimagnétique pointes lisses finition semi-polie en acier inoxydable



L mm 110 CHF 22.70 3 009990019

999D

Brucelles à becs coudés dégagés type aiguille résistant aux acides, antimagnétique pointes lisses finition semi-polie en acier inoxydable



L mm 115 CHF 25.00 3 009990021

999E

Brucelles à becs coudés type aiguille résistant aux acides, antimagnétique pointes lisses finition semi-polie en acier inoxydable



L mm 120 CHF 22.70 3 009990023

999G

Brucelles à becs droits avec blocage type aiguille résistant aux acides, antimagnétique becs croisés lisses finition semi-polie en acier inoxydable



L mm 140 CHF 22.70 3 009990027

999/B6N

ensemble de 6 pinces à épiler, résistant aux acides et au magnétisme



CHF 146.50 1 009990060
999/B6N
999-999A-999B
999C-999D-999E



1002

Pince à anneaux auto-bloquante, becs arrondis striés, en acier inoxydable



L mm 160 CHF 36.50 2 010020001

1008

Pince à becs plats longs striés branches gainées avec double couche de PVC antidérapant



ISO 5745

L mm 160 L1 mm 51,5 CHF 33.50 5 010080006

1008BM

Pince à becs plats longs striés branches gainées confort bi-matériaux



ISO 5745

L mm 160 L1 mm 51,5 CHF 41.00 3 010080036

1009

Pince extra-longue à becs demi-ronds striés, branches gainées avec double couche de PVC antidérapant



ISO 5745

L mm 160 L1 mm 56,5 CHF 33.50 2 010090006

1009L/A

Pince extra-longue à becs demi-ronds striés branches gainées avec double couche de PVC antidérapant



L mm 283 L1 mm 80 CHF 41.00 2 010090008

1009L/B

Pince extra-longue à becs demi-ronds striés coudés à 45° branches gainées avec double couche de PVC antidérapant



L mm 273 L1 mm 73 CHF 41.50 2 010090009

1009L/C

Pince extra-longue à becs demi-ronds striés coudés à 90° branches gainées avec double couche de PVC antidérapant



L mm 253 L1 mm 45 CHF 44.00 2 010090010

1009L/D

Pince extra-longue à becs demi-ronds striés avec double articulation, branches gainées avec double couche de PVC antidérapant



L mm 342 L1 mm 71 CHF 49.00 1 010090058

1009L/DP

Pince extra-longue à becs demi-ronds striés coudés à 45°, avec double articulation, branches gainées avec double couche de PVC antidérapant



L mm 336 L1 mm 66 CHF 49.00 1 010090059

1009L/DP-S2

Jeu de 2 pinces extra-longues à becs demi-ronds striés avec double articulation



1009L/DP-S2 CHF 98.00 1 010090060

1010

Pince à becs ronds long striés branches gainées avec double couche de PVC antidérapant



ISO 5745

L mm 160 L1 mm 51,5 CHF 33.50 2 010100006

1010BM

Pince à becs ronds long striés branches gainées confort bi-matériaux



ISO 5745

L mm 160 L1 mm 51,5 CHF 41.00 2 010100036

Beta

PINCES CIRCLIPS (TYPE SEEGER)

ALIGNEMENT PARFAIT

Des tests ont montré que les pinces circlips de type Seeger de Beta offrent une excellente résistance à l'usure grâce à la géométrie spéciale des pointes obtenue grâce à la technologie du formage à froid.



RUPTURE DE POINTE RÉDUITE

Les pinces Beta sont équipées de pointes pressées à froid, qui permettent d'offrir une longévité accrue lors de son utilisation ou en cas de chute accidentelle.



1031/S4

Jeu de 4 pinces pour circlips



	CHF		
1031/S4	143.00	1	010310000
1032 180			19 ÷ 60 mm
1034 170			19 ÷ 60 mm
1036 175			19 ÷ 60 mm
1038 175			19 ÷ 60 mm

1032

Pince pour circlips intérieurs à becs droits



UNI 7914 DIN 5256

L mm	∅ mm	CHF		
140x0,9	8÷12	31.50	5	010320013
140x1,3	12÷25	31.00	5	010320014
180	19÷60	33.50	5	010320017
225	40÷100	41.50	3	010320021
300	85÷200	58.00	2	010320028

1033

Pince pour circlips intérieurs à becs coudés à 45°



UNI 7914 DIN 5256

L mm	∅ mm	CHF		
140x0,9	8÷12	36.00	5	010330013
140x1,3	12÷25	34.50	5	010330014
180	19÷60	36.50	5	010330017
225	40÷100	45.00	3	010330021

1034

Pince pour circlips intérieurs à becs coudés à 90°



UNI 7914 DIN 5256

L mm	∅ mm	CHF		
130x0,9	8÷12	36.00	5	010340013
130x1,3	12÷25	34.50	5	010340014
170	19÷60	36.50	5	010340017
210	40÷100	45.00	3	010340021
290	85÷200	64.00	2	010340028

1034L

Pince pour circlips intérieurs à becs longs coudés à 90°



L mm	∅ mm	CHF		
190	40÷100	92.50	2	010340320

1036

Pince pour circlips extérieurs à becs droits



UNI 7915 DIN 5254

L mm	∅ mm	CHF		
140x0,9	3÷10	34.00	5	010360013
140x1,3	10÷25	33.50	5	010360014
175	19÷60	34.50	5	010360017
225	40÷100	44.00	3	010360021
300	85÷200	69.00	2	010360028

1037

Pince pour circlips extérieurs à becs coudés à 45°



UNI 7915 DIN 5254

L mm	∅ mm	CHF		
140x0,9	3÷10	38.50	5	010370013
140x1,3	10÷25	36.50	5	010370014
175	19÷60	38.50	5	010370017
225	40÷100	47.00	3	010370021

1038

Pince pour circlips extérieurs à becs coudés à 90°



UNI 7915 DIN 5254

L mm	∅ mm	CHF		
135x0,9	3÷10	38.50	5	010380013
135x1,3	10÷25	36.50	5	010380014
175	19÷60	38.50	5	010380017
220	40÷100	47.00	3	010380021
300	85÷200	74.50	2	010380028

1039

Pince pour circlips réversible à becs droits



L mm	Ø mm	Ø mm	CHF	Icon	Icon
150	10÷15	6÷25	80.50	2	010390015

1558/C4

Outil pour circlips de moyeux intérieurs et extérieurs avec actionnement à vis

Le coupleur carré 3/8" permet d'appliquer une force élevée dans les deux conditions d'utilisation
Ergots fournis : Ø 2,5-3-3,5 mm



L mm	Ø mm	Ø mm	CHF	Icon	Icon
1558/C4	5,5 ÷ 77	5,5 ÷ 77	217.50	1	015580100

330x220x50 mm - 900 g

1044

Pince multiprise standard branches recouvertes de 2 couches de PVC antiglisse

· nouveau modèle neuf positions



ISO 8976

L mm	A max mm	L1 mm	CHF	Icon	Icon
250	48	39	41.50	5	010440250

1044F

Pince multiprise standard finition brunie branches recouvertes en PVC

· modèle neuf positions



ISO 8976

L mm	A max mm	L1 mm	CHF	Icon	Icon
250	48	39	32.00	5	010440015

1047

Pince multiprise entrepassée avec bouton de réglage, poignées recouvertes de 2 couches de PVC antiglisse



L mm	A max mm	L1 mm	CHF	Icon	Icon
180	30	29	54.50	2	010470180
240	36	35	58.00	2	010470240
300	50	48	83.50	1	010470300

1047BM

Pince multiprise entrepassée avec bouton de réglage, branches bi-matière



L mm	A max mm	L1 mm	CHF	Icon	Icon
240	36	35	66.50	2	010470340

POLIGRIP - 1048N PINCE MULTIPRISE ENTREPASSÉE

ADHÉRENCE EXCEPTIONNELLE ET AGREABLE MANIABILITÉ

- Géométrie et angle des dents conçue pour une prise efficace et sûre sur les profils hexagonaux et cylindriques
- Dents soumises à un processus de trempe par induction pour améliorer la durée de vie.
- Largeur supérieure de l'angle tête-branche pour une meilleure ergonomie
- Butée du manche afin d'éviter toute blessure accidentelle de la main
- Branches en PVC antidérapant innovant
- Manipulation et confort extraordinaires grâce à la surface de contact améliorée de la branche



1048N

Pince multiprise entrepassée branches gainées avec PVC antidérapant



ISO 8976

L mm	A max mm	L1 mm	S mm	CHF	Icon	Icon
175	36	31	11	34.50	3	010480910
250	46	38	13	36.50	5	010480915
300	60	44	14.8	54.50	2	010480920

1048N/D3

Jeu de pinces multiprise entrepassées

Tête phosphatée



1048N/D3	CHF	Icon	Icon
175-250-300 mm	126.00	1	010480923

1048BM

Pince multiprise entrepassée branches bimatières

· nouveau modèle neuf positions



ISO 8976

L mm	A max mm	L1 mm	CHF	Icon	Icon
250	48	39	57.50	3	010480215

1048VN

Pince multiprise entrepassée vernis orange



ISO 8976

L mm	A max mm	L1 mm	CHF	Icon	Icon
175	36	31	34.00	3	010480111
250	46	38	39.00	5	010480116
300	60	44	57.00	2	010480121

1050

Pince-étau à becs courts

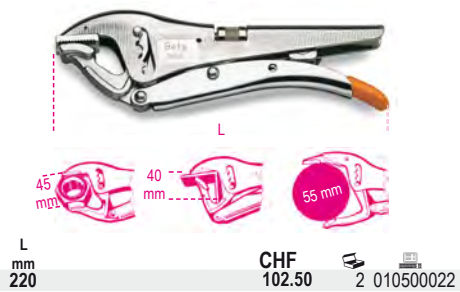

L mm 220 CHF 102.50 2 01050022

1051

Pince-étau à becs longs



L mm 255 CHF 111.00 2 010510025

1051GM

Pince-étau à becs longs articulés

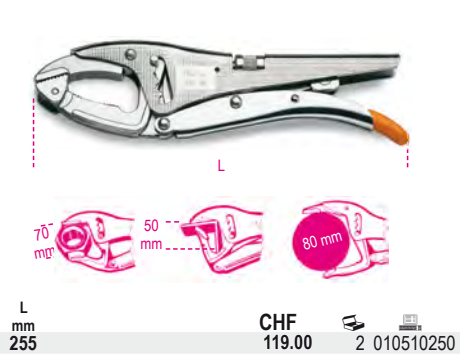

L mm 255 CHF 119.00 2 010510250

1051L

Pince-étau à becs longs grande capacité



L mm 270 CHF 127.00 2 010510100

1051XL

Pince-étau à becs extra-longue grande capacité



L mm 270 CHF 152.50 2 010510140

1052

Pince-étau universelle à mâchoires concaves



L mm	A1 max mm	CHF		
140	22	34.00	3	010520014
190	36	38.50	3	010520019
240	42	41.50	3	010520024
300	55	69.00	2	010520030

1053

Pince-étau à bec inférieur pivotant

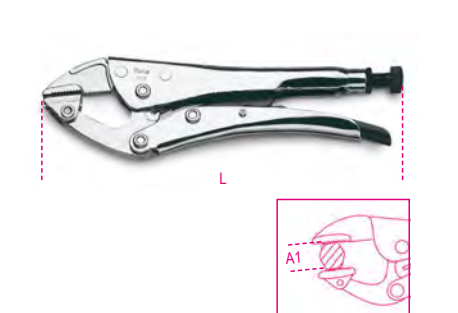

L mm 240 A1 max mm 35 CHF 58.00 2 010530024

1054

Pince-étau à becs droits

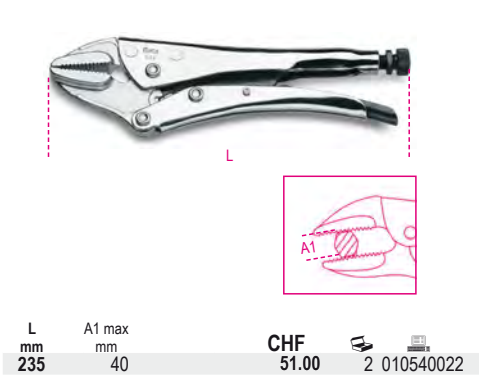

L mm 235 A1 max mm 40 CHF 51.00 2 010540022

1055

Pince-étau à becs arrondis

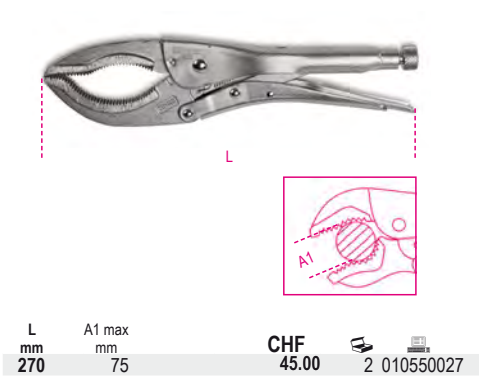

L mm 270 A1 max mm 75 CHF 45.00 2 010550027

1055D

Pince-étau pour écrous et profilés cylindriques

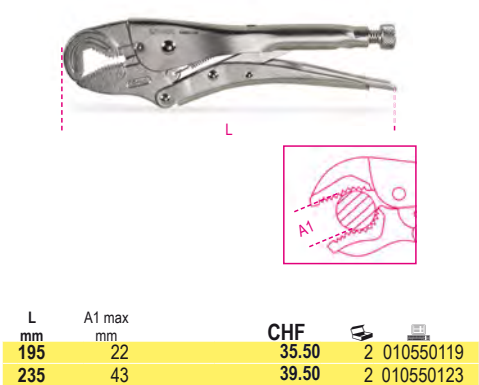

L mm 195	A1 max mm 22	CHF 35.50	2	010550119
235	43	39.50	2	010550123

1056

Pince-étau pour frigoristes

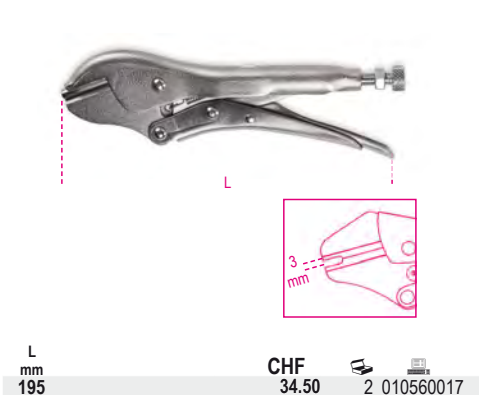

L mm 195 CHF 34.50 2 010560017



1057A

Pince-étau automatique
avec réglage de la force



L mm	CHF		
240	71.50	2	010570124

1058

Pince-étau à becs longs et fins

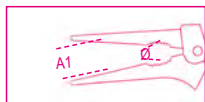

L mm	A1 max mm	Ø max mm	CHF		
175	34	26	43.50	2	010580017
225	46	31	52.00	2	010580025

1059

Pince-étau serre-joints

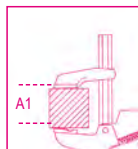
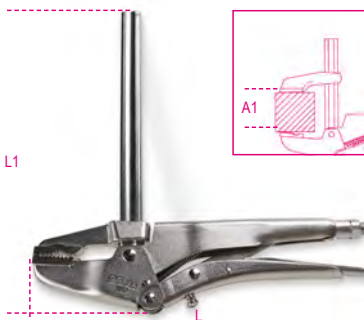

L1 mm	L mm	A1 mm	CHF		
160	255	120	77.50	1	010590016
270	255	220	81.00	1	010590027



1060

Pince-étau pour cornières

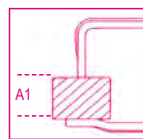

L mm	A1 max mm	CHF		
200	50	55.00	2	010600020
280	80	69.50	2	010600028

1061

Pince-étau pour tubes

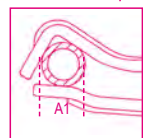

L mm	A1 max mm	CHF		
275	80	60.00	2	010610027

1062

Pince-étau col de cygne

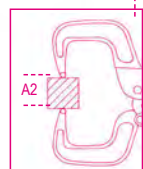

L mm	A2 max mm	CHF		
170	50	42.50	2	010620017
290	120	57.00	2	010620029
460	255	80.50	1	010620045

1062AL

Pince-étau col de cygne "soudure à l'arc"
en aluminium

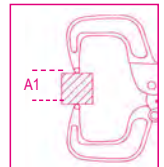

L mm	A1 max mm	CHF		
275	88	75.00	2	010620327

1062GM

Pince-étau col de cygne
à mâchoires orientables

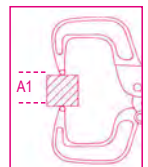

L mm	A1 max mm	CHF		
170	45	46.50	2	010620217
290	88	65.50	2	010620229
460	255	93.00	1	010620245

1063

Pince-étau de tôlier

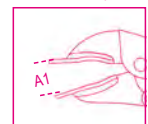

L mm	A1 max mm	CHF		
200	31	56.00	2	010630021



1064

Pince-étau à chaîne



L mm	Ø mm	CHF	🔧	📄
230	150	79.50	2	010640023

1065F

Pince à poinçonner

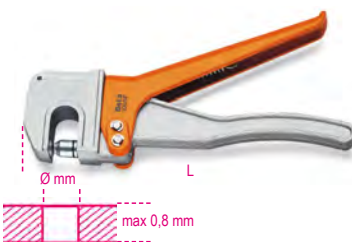

Ø mm	L mm	CHF	🔧	📄
5	228	152.00	1	010650010
6	228	153.00	1	010650015

1065P

Pince à plier



L mm	CHF	🔧	📄
228	156.00	1	010650020

1066

Pince-étau verrouillage à 90°

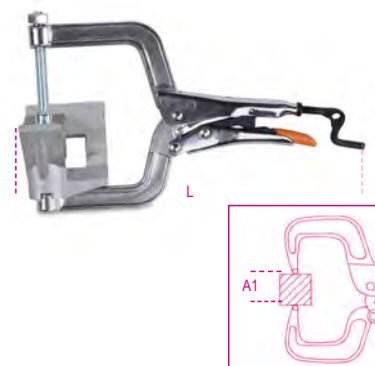

L mm	A1 max mm	g	CHF	🔧	📄
210	55	500	104.50	1	010660021

1067

Pince-étau pour tubes, mâchoires bloque-tube articulées

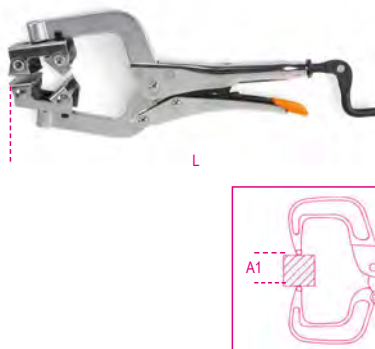

L mm	A1 max mm	CHF	🔧	📄
285	76	66.50	1	010670285
380	89	68.00	1	010670380

1077

Pince à becs larges droits pour tôlier, branches gainées PVC



L mm	A mm	L1 mm	CHF	🔧	📄
280	60	53	68.00	1	010770026

1078

Pince à becs larges coudés à 45° pour tôlier, branches gainées PVC



L mm	A mm	L1 mm	CHF	🔧	📄
280	60	77	69.50	1	010780026

1080D

Pince coupante diagonale branches gainées avec double couche de PVC antidérapant

Pour la coupe des matériaux tendres

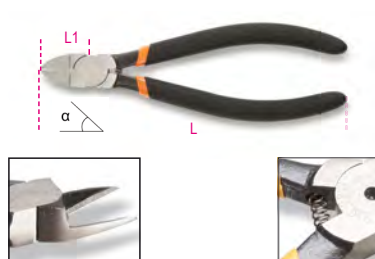

α	L mm	L1 mm	CHF	🔧	📄
15°	160	22	36.50	3	010800015
45°	160	22	44.00	3	010800045

1081

Pince coupante semi-rase branches gainées avec double couche de PVC antidérapant

• Pour micromécanique et électronique contraignantes



L mm	L1 mm	CHF	🔧	📄
125	16	38.00	3	010810130

1082

Pince coupante diagonale, chromée, branches gainées avec double couche de PVC antidérapant



UNI/ISO 5749

L mm	L1 mm	mm	CHF	🔧	📄
140	20	1,6	33.00	5	010820004
160	22	1,6	34.00	5	010820006

1082G

Pince coupante diagonale, branches gainées avec double couche de PVC antidérapant, finition industrielle



INDUSTRIAL FINISHING

UNI/ISO 5749

L mm	L1 mm	mm	CHF	🔧	📄
140	20	1,6	28.00	5	010820064
160	22	1,6	29.50	5	010820066

1082BM

Pince coupante diagonale, branches gainées confort bi-matières



UNI/ISO 5749

L mm	L1 mm	mm	CHF	🔧	📄
140	20	1,6	41.00	3	010820034
160	22	1,6	44.50	3	010820036

1082GBM

Pince coupante diagonale, branches gainées confort bi-matières, finition industrielle



INDUSTRIAL FINISHING

UNI/ISO 5749

L mm	L1 mm	mm	CHF		
140	20	1,6	36.00	3	010820264
160	22	1,6	40.50	3	010820266

1084

Pince coupante diagonale à faible effort de coupe, chromée, branches gainées avec double couche de PVC antidérapant



UNI/ISO 5749

L mm	L1 mm	mm	CHF		
160	22	1,6	38.50	5	010840006
200	28	2,0	47.50	3	010840010

1084G

Pince coupante diagonale à faible effort de coupe, branches gainées avec double couche de PVC antidérapant, finition industrielle



INDUSTRIAL FINISHING

UNI/ISO 5749

L mm	L1 mm	mm	CHF		
160	22	1,6	33.50	5	010840066
200	28	2,0	41.50	3	010840070

1084BM

Pince coupante diagonale à faible effort de coupe, chromée, branches gainées confort bi-matières



UNI/ISO 5749

L mm	L1 mm	mm	CHF		
160	22	1,6	46.50	3	010840036
200	28	2,0	60.00	3	010840040

1084GBM

Pince coupante diagonale à faible effort de coupe, branches gainées confort bi-matières, finition industrielle



INDUSTRIAL FINISHING

UNI/ISO 5749

L mm	L1 mm	mm	CHF		
160	22	1,6	51.50	3	010840266
200	28	2,0	65.50	3	010840270

1088

Pince coupante frontale à faible effort de coupe, branches gainées avec double couche de PVC antidérapant

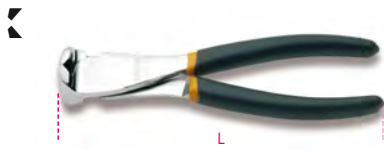

UNI/ISO 5748

L mm	L1 mm	mm	CHF		
160	9	1,6	47.00	2	010880006
200	11	2,0	62.00	2	010880010

1088BM

Pince coupante frontale à faible effort de coupe, branches gainées confort bi-matières



UNI/ISO 5748

L mm	L1 mm	mm	CHF		
160	9	1,6	57.50	2	010880036
200	11	2,0	78.50	2	010880040

1092V

Pince coupante frontale articulée



UNI/ISO 5748

L mm	L1 mm	mm	CHF		
180	8	2,0	188.00	2	010920280
200	9	2,5	198.50	2	010920310

1094V

Pince coupante diagonale articulée



UNI/ISO 5749

L mm	L1 mm	mm	CHF		
200	23	2,5	188.00	2	010940200

1095N

Pince coupante diagonale articulée



L mm	L1 mm	mm	CHF		
195	26	1,6	66.50	2	010950010

1096

Tenaille de menuisier



ISO 9243

L mm	L1 mm	CHF		
160	21	25.50	5	010960016
200	23	29.50	5	010960020
250	30	39.50	5	010960025



1098

Tenaille type russe



ISO 9242 DIN 5242

L	L1	CHF		
mm	mm			
190	12	25.50	5	010980190
220	13	28.50	5	010980220
250	15	34.00	5	010980250
280	18	38.00	5	010980280

1098PL

Tenaille type russe, branches gainées PVC



ISO 9242 DIN 5242

L	L1	CHF		
mm	mm			
220	13	31.50	5	010980320
250	15	36.50	5	010980350
280	18	40.50	5	010980380

1101

Coupe-boulons, poignées en caoutchouc et bras en acier tubulaire



L	L	CHF		
mm	mm			
300	12	75.00	2	011010030
350	14	91.50	2	011010035
450	18	112.00	1	011010045
600	24	153.50	1	011010060
750	30	198.50	1	011010075
900	36	266.00	1	011010090

L	R = 80	R = 140	g	
mm	Kgf/mm ²	Kgf/mm ²		
	Ø mm	Ø mm		
300	5	4	745	
350	6	5	1043	
450	7	6	1537	
600	9	7	2540	
750	11	8	3870	
900	12	9	6170	



1101R

Lames pour 1101



mm	1101	CHF		
300	300	44.50	1	011010130
350	350	52.00	1	011010135
450	450	66.50	1	011010145
600	600	90.00	1	011010160
750	750	111.00	1	011010175
900	900	147.00	1	011010190

1102

Mini-coupe boulons

R= 80 Kgf/mm²



L	mm	CHF		
230	4	56.00	3	011020020

1103

Coupe-treillis à tête plate pour tiges, boulons et treillis électrosoudés à béton

Ø max. = 12 mm
Ø max. (HRC 48) = 6 mm



L	CHF		
mm			
950	199.50	1	011030090

1103R

Tête pour 1103



1103R 950	CHF		
	118.50	1	011030190

1104

Coupe-câbles gros effort pour câbles flexibles en acier branches en matière plastique



R=80 Kgf/mm²

L	mm	CHF		
420	12	193.00	1	011040004
600	16	281.00	1	011040006

1104R

Lames pour 1104



mm	CHF		
420	119.50	1	011040014
600	166.50	1	011040016

1105

Emporte-pièces en acier



D	L	CHF		
mm	mm			
2	27	19.20	1	011050002
3	27	19.20	1	011050003
4	27	19.20	1	011050004
5	27	19.20	1	011050005
6	27	19.20	1	011050006
7	27	19.20	1	011050007
8	27	19.20	1	011050008
9	27	19.20	1	011050009
10	27	19.20	1	011050010
12	27	23.60	1	011050012
14	27	23.60	1	011050014
16	27	23.60	1	011050016
18	27	23.60	1	011050018
20	27	23.60	1	011050020
22	32	29.50	1	011050022
24	32	29.50	1	011050024
26	32	29.50	1	011050026
28	32	29.50	1	011050028
30	32	29.50	1	011050030
32	37	38.50	1	011050032
34	37	38.50	1	011050034
36	37	38.50	1	011050036
38	37	38.50	1	011050038
40	37	38.50	1	011050040
42	42	45.00	1	011050042
44	42	45.00	1	011050044
46	42	45.00	1	011050046
48	42	45.00	1	011050048
50	42	45.00	1	011050050

1105T20

Poignée pour emporte-pièces 1105, 2-20 mm



L mm	CHF		
110	95.50	1	011050200

1105T30

Poignée pour 1105, 3-30 mm



L mm	CHF		
175	205.00	1	011050205

1105T50

Poignée pour 1105, 2-50 mm



L mm	CHF		
175	202.50	1	011050207

1105AD-50

Adaptateur pour 1105T50



∅ mm	CHF		
57	128.50	1	011050210

1105/C10T

Assortiment de 10 emporte-pièces, 3-20 mm, et 1 accessoire



1105/C10T	CHF		
	213.00	1	011050250

1105	3 - 4 - 6 - 8 - 10 - 12 - 14 - 16 - 18 - 20 mm
1105T20	
24x210x60 mm	

1105/C16T

assortiment de 15 emportes pièces , 3 à 30 mm, et 1 accessoire



1105C/16T	CHF		
	386.00	1	011050255

1105	3 - 4 - 6 - 8 - 10 - 12 - 14 - 16 - 18 - 20 - 22 - 24 - 26 - 28 - 30 mm
1105T30	
240x210x60 mm	

1105/C32T

assortiment de 29 emportes pièces, 2 à 50 mm, et 3 accessoires



1105/C32T	CHF		
	753.00	1	011050257

1105	2 - 3 - 4 - 5 - 6 - 7 - 8 - 9 - 10 - 12 - 14 - 16 - 18 - 20 - 22 - 24 - 26 - 28 - 30 - 32 - 34 - 36 - 38 - 40 - 42 - 44 - 46 - 48 - 50 mm
1105T50	
1105AD-50	
455x380x115 mm	

1112

Cisaille type américain coupe droite

R = ± 0.05 60 Kg/mm²



L	L1	S	A	CHF		
200	50	0,5	26	33.50	2	011120020
250	62	0,8	33	40.50	2	011120025
300	76	1,0	37	52.00	2	011120030
375	76	1,2	44	76.00	1	011120037

1114

Cisaille type américain bichantourneuse bec de canard
R = 60 Kg/mm²



L	L1	S	A	CHF		
250	58	0,5	15	36.00	1	011140265
350	76	1	22	47.00	1	011140340

1118

Cisaille anti-accidents pour feuillard

Fe = acier normal
Inox = acier inoxydable



L	L1	Fe S mm	Inox S mm	CHF		
310	42	1	0,8	59.00	2	011180001

1120A

Cisaille grignoteuse

Fe = acier normal



L	Fe S mm	CHF		
280	1,2	94.00	1	011200101

1120ARL - ARG

Lames pour article 1120A



1120ARL	CHF		
	23.40	1	011200110
1120ARG	CHF		
	29.50	1	011200120

1122

Cisaille bichantourneuse coupe droite

« Type Aviation »

Inox = acier inoxydable



L	L1	Inox S mm	A	CHF		
250	40	1	24	45.00	2	011220020

1123

Cisaille chantourneuse coupe droite
«Type Aviation»

Inox = acier inoxydable



L	L1	Inox	A	CHF		
~ 250	mm 40	S mm 1	mm 24	45.00	2	011230020

1124

Cisaille chantourneuse coupe à gauche
«Type Aviation»

Inox = acier inoxydable



L	L1	Inox	A	CHF		
~ 250	mm 40	S mm 1	mm 24	45.00	2	011240020

1125

Cisaille chantourneuse démultipliée
coupe droite et à droite

Inox = acier inoxydable

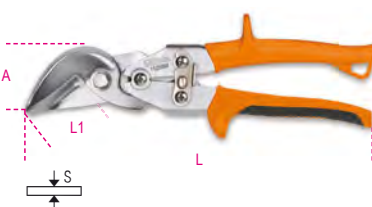

L	L1	Inox	A	CHF		
~ 250	mm 35	S mm 1	mm 46	70.50	2	011250020

1126

Cisaille chantourneuse démultipliée
coupe droite et à gauche

Inox = acier inoxydable

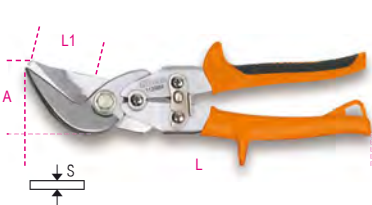

L	L1	Inox	A	CHF		
~ 250	mm 35	S mm 1	mm 46	70.50	2	011260020

1122 - 1125MOL



		CHF		
1122 MOL	1122 - 1124	2.04	1	011220010
1123 MOL	1123	1.73	1	011230010
1125 MOL	1125 - 1126	1.73	1	011250040

1127

Ciseaux de téléphoniste, lames droites



L	L1	CHF		
mm 150	mm 35	20.00	5	011270001

1128BAX

Ciseaux d'électriciens à double effet,
avec profils à foret en acier inoxydable revêtu
en DLC

Coupe à double effet : à travers une came spéciale sur le point d'appui, l'on obtient un déplacement longitudinal des lames qui, lors de la phase de fermeture, en augmente la puissance de coupe.

Profil et foret : étudiés pour élargir les orifices sur plastique de 13 à 25 mm.

Revêtement DLC : le carbone de type diamant (DLC - diamond-like carbon) est un revêtement innovant à base de carbone : la grande dureté et le faible coefficient de frottement sont dus à la présence simultanée de carbone déposé sur la surface en forme de graphite et diamant.

- Grande dureté superficielle des lames (résistance à l'abrasion et maintien de l'affûtage dans le temps)
- Faible coefficient de frottement (glissement et puissance de coupe)
- Embout excentrique anti-ralentissement
- Branches amples avec gorges auto-serrantes
- Fournis avec étui en plastique articulé



L	L1	mm ²	CHF		
mm 150	mm 50	50	44.00	5	011280088

1128BMX

Ciseaux d'électricien
lames droites en acier inoxydable, avec
micro-denture



L	L1	CHF		
mm 147	mm 58,2	23.40	5	011280051

1128BMX/F

Étui plastique articulé
pour 1128BMX



1128BMX/F		CHF		
		2.37	1	011280059

Beta

1128FXS CISEAU D'ÉLECTRICIEN AVEC ÉVASEUR

Pour repenser nos ciseaux d'électricien, nous avons observé le travail quotidien des utilisateurs. Nous en avons fait un outil universel, intégrant les 4 fonctionnalités principales dans un seul outils.

COUPE Rapide et nette, pour câbles jusqu'à 50 mm², avec une gorge coupe-câble et une lame micro-dentée, pour une meilleure prise.

DENUDAGE La sensibilité de l'embout anti-desserrement permet de dénuder avec précision les câbles les plus fins.

SERTISSAGE Sûr et résistant pour les cosses de tubulaires.

EVASEMENT Le profil à fraise permet d'élargir les orifices des de dérivation de manière précise et nette.



1128BAX CISEAUX D'ÉLECTRICIEN À DOUBLE EFFET AVEC ÉVASEUR EN ACIER INOXYDABLE ET REVÊTEMENT DLC

Les ciseaux 1128BAX se distinguent par leurs lames au revêtement DLC. Le DLC (diamond-like carbon) est un revêtement innovant à base de carbone dont la dureté élevée et le faible coefficient de frottement résultent de la présence simultanée de carbone à la surface sous forme de graphite et de diamant.

- Dureté élevée de la surface de la lame - résistance à l'abrasion et à l'usure
- Faible coefficient de frottement - et anti-adhérent

Profil de fraisage : conçu pour agrandir les trous sur du plastique, de 13 mm à 25 mm.



+DE DURETÉ
-DE COEFFICIENT DE FRICTION



1128BSX

Ciseaux d'électricien avec évaseur

conçus pour élargir les trous sur le plastique et pour fermer les tuyaux plissés



L mm	L1 mm	CHF	5	011280061
148	58,2	40.50		

1128FX

Ciseaux d'électricien lames droites en acier inoxydable avec micro-denture, gorge coupe-câble et pince à sertir pour cosses tubulaires

- Étui articulé accrochable à la ceinture
- Branches bi-matières
- Embout anti-dévisage



L mm	L1 mm	mm ²	CHF	5	011280090
145	52	50	42.50		

1128FXS

Ciseaux d'électricien avec évaseur, lames droites en acier inoxydable avec micro-denture, gorge coupe-câble et pince à sertir pour cosses tubulaires

- Étui articulé accrochable à la ceinture
- Branches bi-matières
- Embout anti-dévisage

• Profil et foret : conçus pour élargir les trous sur plastique de 13 à 21 mm



L mm	L1 mm	mm ²	CHF	5	011280095
145	52	50	51.00		

1128BM

Ciseaux d'électricien, lames droites



L mm	L1 mm	CHF	5	011280000
145	50	20.30		

1129BM

Ciseaux d'électricien, lames courbées



L mm	L1 mm	CHF	5	011290000
145	44	21.70		

1130BMX

Ciseaux multifonctions lames droites en acier inoxydable avec micro-denture



L mm	L1 mm	CHF	1	011300002
185	60	26.00		

1131CK

Ciseaux pour Kevlar® et fibres optiques

en acier, spécialement conçus pour travailler sur les matériaux anti-coupeure tels que les fibres d'aramides, p. ex. Kevlar®
Egalement pour fibres optiques



L mm	L1 mm	CHF	1	011310001
203	75	105.50		

1132

Coupe-câbles branches gainées
avec double couche de PVC antidérapant



UNI 8791

L	mm	mm ²	CHF		
170	14	50	64.00	2	011320107
230	18	95	78.50	2	011320113

1132BM

Coupe-câbles branches gainées
confort bi-matières



UNI 8791

L	mm	mm ²	CHF		
170	14	50	78.50	2	011320137
230	18	95	96.50	2	011320143

1133

Coupe-câbles pour câbles en cuivre flexible

jusqu'à 325 mm²



L	mm	mm ²	CHF		
600	32	300	219.50	1	011330001

1133RL

Lames pour 1133



1133RL

CHF 165.00 1 011330011

1134

Coupe-câbles à cliquet



L	mm	mm ²	CHF		
260	35	400	639.00	1	011340032

1134RL

Lames pour 1134



1134RL

CHF 290.00 1 011340132

1134A

Coupe câble à cliquet



L	mm	mm ²	CHF		
240	45	500	971.00	1	011340045

1134A/RL

Lames pour 1134A



1134A/RL

CHF 446.00 1 011340145



Beta

1142BM

Pince à dénuder branches gainées
confort bi-matières



UNI 7923

L	mm	mm ²	mm	CHF		
160	0,5÷6	0-2,8		52.00	3	011420036

1143

Pince à dénuder automatique latérale



L	mm	mm ²	mm	CHF		
165	0,5÷6	1-3,2		102.50	1	011430001

1143R

Lames pour 1143

1143R	CHF		
	26.00	1	011430011

1144D

Dénudeur



L	mm	mm ²	mm	CHF		
170	4,5÷240	2,5-18		122.50	1	011440010

1144D/RG

Crochet de rechange pour 1144D



1144D/RG	CHF		
	41.00	1	011440012

1144D/RL

Lames pour 1144D

1144D/RL	CHF		
	62.50	1	011440011

1144G

Dénudeur

Avec lame réglable pour coupes transversales et longitudinales



L	mm	mm ²	mm	CHF		
140	6÷75	2.8-12		68.00	1	011440004

1144G/RL

Lame pour 1144G



1144G/RL	CHF	15.10	1	011444005
----------	-----	-------	---	-----------

1144L

Dénudeur avec lame réglable pour coupes transversales et longitudinales

Avec lame rétractile lisse et à crochet



L mm	 mm ²	 mm	CHF	39.50	1	0114440050
145	6-150	4-28				

1144T

Dénudeur de poche réglable, avec dispositif de coupe



L mm	 mm	 g	CHF	27.50	1	0114440060
112	3,5 ÷ 9	40				

1148A

Pince à dénuder automatique

10 mm² (8 AWG) câbles flexibles
1,5 mm² (16 AWG) câbles rigides



L mm	 mm ²	 mm	CHF	209.50	1	011480100
190	0,02-10	0-4				

1148A/R

Paire de mors pour 1148A



1148A/R	CHF	90.00	1	011480102
---------	-----	-------	---	-----------



1148B

Pince à dénuder automatique



L mm	 mm ²	 mm	CHF	246.00	1	011480200
190	4-16	2-5				

1148B/R

Paire de mors pour 1148B



1148B/R	CHF	112.00	1	011480202
---------	-----	--------	---	-----------

1148P

Pince à dénuder automatique



L mm	 mm ²	 mm	CHF	59.00	1	011480300
165	0.2-6	0-3.5				

1149F

Pince à dénuder frontale autoréglable, avec dispositif de coupe



L mm	 mm ²	CHF	22.70	1	011490010
175	0,2 ÷ 6				

1150

Pince universelle chromée polie branches gainées avec double couche de PVC antidérapant

• L'embout décentré augmente l'effet de levier tout en réduisant l'effort, pour un coupe de grande puissance.



ISO 5746

L mm	L1 mm	 mm	CHF			
160	42	1,6	29.00	5	011500046	
180	46	1,8	31.50	5	011500048	
200	50	2,0	34.00	5	011500050	
220	50	2,0	38.00	2	011500052	

1150G

Pince universelle, branches gainées avec double couche de PVC antidérapant, modèle grande capacité, finition industrielle

• Excellent rapport qualité/prix
• L'embout décentré augmente l'effet de levier tout en réduisant l'effort, pour un coupe de grande puissance.



ISO 5746

L mm	L1 mm	 mm	CHF			
160	42	1,6	27.00	5	011500066	
180	46	1,8	29.50	5	011500068	
200	50	2,0	33.00	5	011500070	
220	50	2,0	34.00	2	011500072	



1150HPC PINCE UNIVERSELLE HYPERCUT À GRANDE FORCE DE COUPE AVEC TRANCHANTS EN ACIER FRITTÉ M2

- L'axe décentré permet au point d'appui d'être plus proche du point de coupe, ce qui améliore l'effet de levier.
- L'alignement parfait des becs et le profil affiné garantissent une prise sûre même dans les espaces réduits.
- Le corps de la pince est constitué d'un acier au molybdène qui a subi un traitement thermique afin d'apporter flexibilité et résistance pour garantir une prise en main sûre.

Contrainte de cisaillement -
essai statique =

-73%

Durée de vie moyenne des arêtes
de coupe (test ISO 5744) =

+127%

Dureté des tranchants en acier M2 =

65HRC

RÉVOLUTIONNAIRE

**FINITION CHROMÉE
PERLÉE**

**CAPACITÉ DE COUPE
REMARQUABLE**

1150HPC

Pince universelle à grande force de coupe avec tranchant à insert et embout décentré Chromée satinée avec branches gainées bi-matières et joint ouvert

Tranchant à insert
Acier : M2
Épaisseur : 0,20 mm
Angle : 62°
Dureté : 63+65 HRC



ISO 5746

L mm	L1 mm	mm	CHF		
180	42	1,8	78.00	2	011500618

1150BM

Pince universelle chromée polie branches gainées confort bi-matières

- L'embout décentré augmente l'effet de levier tout en réduisant l'effort, pour un coupe de grande puissance.



ISO 5746

L mm	L1 mm	mm	CHF		
160	42	1,6	36.00	3	011500146
180	46	1,8	39.50	3	011500148
200	50	2,0	43.50	3	011500150
220	50	2,0	46.50	2	011500152

1150GBM

Pince universelle, branches gainées confort bi-matières, modèle grande capacité, finition industrielle

- L'embout décentré augmente l'effet de levier tout en réduisant l'effort, pour un coupe de grande puissance.
- Excellent rapport qualité/prix



ISO 5746

L mm	L1 mm	mm	CHF		
160	42	1,6	33.50	3	011500266
180	39	1,8	36.00	3	011500268
200	50	2,0	41.00	3	011500270
220	50	2,0	43.50	2	011500272

1153

Pince universelle réglable "mécanicien", branches gainées PVC



UNI ISO 9343

L mm	L1 mm	CHF		
200	34	33.00	2	011530120

1162

Pince à becs plats longs striés, chromée, branches gainées avec double couche de PVC antidérapant



ISO 5745

L mm	L1 mm	mm	CHF		
160	58	1,6	34.00	5	011620006
200	86	1,6	39.50	5	011620010



1162G

pince à becs plats longs striés,
branches gainées avec double couche
de PVC antidérapant,
 finition industrielle

• Excellent rapport qualité/prix



ISO 5745

L mm	L1 mm	mm	CHF	5	3
160	58	1,6	29.00	5	011620066
200	86	1,6	33.50	5	011620070

1162BM

Pince à becs plats
longs striés,
chromée,
branches gainées confort bi-matières



ISO 5745

L mm	L1 mm	mm	CHF	5	3
160	58	1,6	41.50	5	011620036
200	86	1,6	46.50	3	011620040

1162GBM

Pince à becs plats
longs striés,
branches gainées confort bi-matières,
 finition industrielle

• Excellent rapport qualité/prix



ISO 5745

L mm	L1 mm	mm	CHF	5	3
160	58	1,6	36.00	5	011620266
200	86	1,6	42.00	3	011620270

1164

Pince à becs coulés plats longs striés
branches gainées avec double couche
de PVC antidérapant



ISO 5745

L mm	L1 mm	mm	CHF	5	3
160	54	1,6	37.00	5	011640006
200	76	1,6	41.50	5	011640010

1164BM

Pince à becs coulés plats longs striés
branches gainées confort bi-matières



ISO 5745

L mm	L1 mm	mm	CHF	5	3
160	54	1,6	45.00	3	011640036
200	76	1,6	51.50	3	011640040

1166

Pince à becs demi-ronds
longs striés,
chromée,
branches gainées avec double couche de
PVC antidérapant



ISO 5745

L mm	L1 mm	mm	CHF	5	3
160	56	1,6	34.00	5	011660006
200	76	1,6	39.50	5	011660010

1166G

Pince à becs demi-ronds longs striés,
branches gainées
avec double couche
de PVC antidérapant,
 finition industrielle

• Excellent rapport qualité/prix

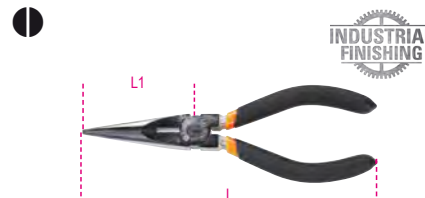

ISO 5745

L mm	L1 mm	mm	CHF	5	3
160	56	1,6	29.00	5	011660066
200	76	1,6	33.50	5	011660070

1166BM

Pince à becs demi-ronds
longs striés,
chromée,
branches gainées confort bi-matières



ISO 5745

L mm	L1 mm	mm	CHF	5	3
160	56	1,6	41.50	3	011660036
200	76	1,6	46.50	3	011660040

1166GBM

Pince à becs demi-ronds longs striés,
branches gainées confort bi-matières,
 finition industrielle

• Excellent rapport qualité/prix

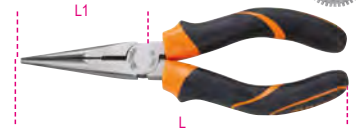

ISO 5745

L mm	L1 mm	mm	CHF	5	3
160	56	1,6	36.00	3	011660266
200	76	1,6	42.00	3	011660270

1168

Pince à becs coulés demi-ronds
longs striés,
chromée,
branches gainées avec double couche de
PVC antidérapant



ISO 5745

L mm	L1 mm	mm	CHF	5	3
160	54	1,6	37.00	5	011680006
200	76	1,6	41.50	5	011680010

1168G

Pince à becs coulés demi-ronds
longs striés,
branches gainées avec double couche
de PVC antidérapant,
 finition industrielle

• Excellent rapport qualité/prix



ISO 5745

L mm	L1 mm	mm	CHF	5	3
160	54	1,6	31.50	5	011680066
200	76	1,6	36.00	5	011680070

1168BM

Pince à becs coudés demi-ronds longs striés, chromée, branches gainées confort bi-matières



ISO 5745

L	L1	mm	CHF		
mm	mm	mm			
160	54	1,6	45.00	3	011680036
200	70	1,6	51.50	3	011680040

1168GBM

Pince à becs coudés demi-ronds longs striés, branches gainées confort bi-matières, finition industrielle

• Excellent rapport qualité/prix



ISO 5745

L	L1	mm	CHF		
mm	mm	mm			
160	54	1,6	40.50	3	011680266
200	70	1,6	45.00	3	011680270

1169/D3

Jeu de 1 pince universelle, 1 pince à becs demi-ronds longs et 1 pince coupante diagonale



1169/D3	CHF		
1082 160mm	100.00	1	011690053
1150 180mm			
1166 160mm			

1169G/D3

Jeu de 1 pince universelle, 1 pince à becs demi-ronds longs et 1 pince coupante, branches gainées avec double couche de PVC antidérapant, finition industrielle

• Excellent rapport qualité/prix



INDUSTRIAL FINISHING

1169G/D3	CHF		
1082G 160mm	88.00	1	011690073
1150G 180mm			
1166G 160mm			

1169BM/D3

Jeu de 1 pince universelle, 1 pince à becs demi-ronds longs et 1 pince coupante diagonale



1169BM/D3	CHF		
1082BM 160mm	126.00	1	011690133
1150BM 180mm			
1166BM 160mm			

1169GBM/D3

Jeu de 1 pince universelle, 1 pince à becs demi-ronds longs et 1 pince coupante, branches gainées confort bi-matières, finition industrielle

• Excellent rapport qualité/prix



INDUSTRIAL FINISHING

1169GBM/D3	CHF		
1082GBM 160mm	112.00	1	011690273
1150GBM 180mm			
1166GBM 160mm			

1171BM

Pince de précision à becs plats courts lisses branches gainées confort bi-matières



ISO 9655

L	L1	A	B	CHF		
mm	mm	mm	mm			
130	18	12	8	57.00	2	011710101

1172BM

Pince de précision à becs plats longs lisses branches gainées confort bi-matières

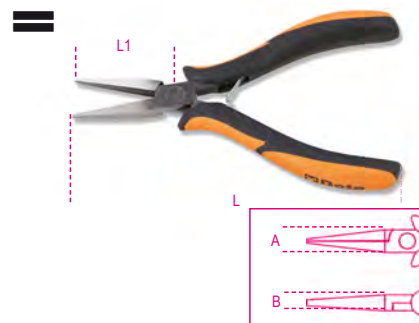

ISO 9655

L	L1	A	B	CHF		
mm	mm	mm	mm			
140	40	12	8	57.00	2	011720101

1172BM/P

Pince de précision à becs plats coudés longs lisses branches gainées confort bi-matières



L	L1	A	B	CHF		
mm	mm	mm	mm			
140	38	12	13	65.00	2	011720102



1173BM

Pince de précision
à becs ronds courts
branches gainées confort bi-matières



ISO 9655

L	L1	A	B	CHF	2	011730101
mm	mm	mm	mm			
125	22	12	8	57.00		

1175BM

Pince de précision
à becs demi-ronds courts lisses
branches gainées confort bi-matières



ISO 9655

L	L1	A	B	CHF	2	011750101
mm	mm	mm	mm			
140	29	12	8	57.00		

1177BM

Pince de précision
à becs demi-ronds longs lisses
branches gainées confort bi-matières

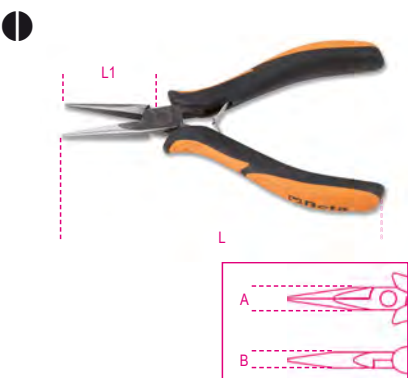

ISO 9655

L	L1	A	B	CHF	2	011770101
mm	mm	mm	mm			
140	38	12	8	57.00		

1177BM/Z

Pince de précision
à becs demi-ronds longs striés
branches gainées confort bi-matières

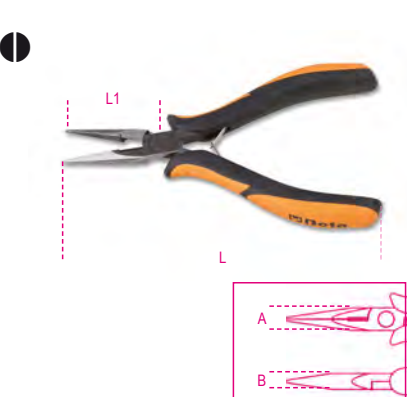

ISO 9655

L	L1	A	B	CHF	2	011770113
mm	mm	mm	mm			
140	39	12	8	65.00		

1178BM

Pince de précision
à becs demi-ronds longs lisses effilés
branches gainées confort bi-matières



ISO 9655

L	L1	A	B	CHF	2	011780101
mm	mm	mm	mm			
140	37	12	8	65.00		

1178BM/P

Pince de précision
à becs coudés demi-ronds longs lisses effilés
branches gainées confort bi-matières



L	L1	A	B	CHF	2	011780102
mm	mm	mm	mm			
140	36,5	12	12	65.00		

À suivre pinces coupantes pour cuivre.
Pour des utilisations plus contraignantes,
consulter l'article 1081

1182BM

Pince coupante diagonale de précision
à becs effilés, coupe semi-rase,
branches gainées confort bi-matières



ISO 9654

L	L1	A	Cu	CHF	2	011820101
mm	mm	mm	mm			
120	11	10	1	65.00		

1183BM

Pince coupante diagonale de précision
à becs arrondis, coupe semi-rase,
branches gainées confort bi-matières



ISO 9654

L	L1	A	Cu	CHF	2	011830101
mm	mm	mm	mm			
120	11	10	1	65.00		



1184BM

Pince coupante diagonale de précision à becs arrondis, coupe à ras, branches gainées confort bi-matières



ISO 9654

L mm	L1 mm	A mm	Cu mm	CHF		
120	11	10	1	65.00	2	011840101
130	13	12,5	1,25	65.00	2	011840102

1185BM

Pince coupante diagonale de précision à becs effilés, coupe à ras, branches gainées confort bi-matières



ISO 9654

L mm	L1 mm	A mm	Cu mm	CHF		
120	11	10	1	65.00	2	011850101
130	13	12,5	1,25	65.00	2	011850102

1186BM

Pince coupante diagonale de précision à becs effilés avec dégagement, coupe à ras, branches gainées confort bi-matières



ISO 9654

L mm	L1 mm	A mm	Cu mm	CHF		
120	11	10	1	65.00	2	011860101
130	13	12,5	1,25	65.00	2	011860102

1188BM

Pince coupante diagonale de précision coupe axiale, branches gainées confort bi-matières



ISO 9654

L mm	L1 mm	A mm	Cu mm	CHF		
125	12	12	1,25	65.00	2	011880101
130	17	15	2	65.00	2	011880102

1190BM

Pince coupante frontale de précision coupe semi-rase, branches gainées confort bi-matières



ISO 9654

L mm	L1 mm	A mm	Cu mm	CHF		
120	12	12	1,25	65.00	2	011900113

1191BM

Pince coupante frontale de précision tête inclinée à 70°, coupe à ras, branches gainées confort bi-matières



ISO 9654

L mm	L1 mm	A mm	Cu mm	CHF		
130	8	12	0,8	65.00	2	011910101

1191BM/L

Pince coupante frontale de précision tête inclinée à 70°, coupe à ras, branches gainées confort bi-matières



ISO 9654

L mm	L1 mm	A mm	Cu mm	CHF		
130	18	12	1	65.00	2	011910110

1191R/5-M

Kit ressorts de rechange pour pinces et pinces coupantes, 5 couples (Articles : 1171...1191)

CHF 12.80 1 011910995

1200MS

Magnétiseur/démagnétiseur

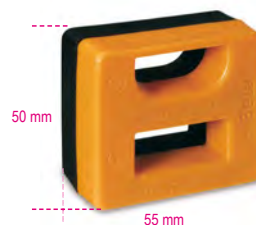

1200MS CHF 20.60 5 012000000



L'ÉVOLUTION DU TOURNEVIS !

Son design ergonomique s'adapte parfaitement à la paume de la main. La vaste surface de contact de la poignée qu'il propose permet de transmettre la plus grande force possible avec un minimum d'effort.

Les lames Beta, dont leurs preuves ne sont plus à démontrer, offrent élasticité, dureté et résistance à l'usure et se positionne dans la catégorie PREMIUM des tournevis professionnels.

La poignée octogonale évite que l'outil ne roule sur le plan de travail.

L'ergonomie précise du manche permet au tournevis de tourner rapidement entre les doigts.

La nouveauté est la possibilité d'accrocher le tournevis par l'orifice présent sur le manche.

La nouvelle gamme de manche thermoplastique octroie un confort supérieur à chaque utilisation, même la plus compliquée.

L'empreinte et la mesure écrite sur la partie sphérique du manche contribuent à une identification rapide.

● Les lames Beta, dont leurs preuves ne sont plus à démontrer, offrent élasticité, dureté et résistance à l'usure et se positionne dans la catégorie PREMIUM des tournevis professionnels.

● Son design ergonomique s'adapte parfaitement à la paume de la main. La vaste surface de contact de la poignée qu'il propose permet de transmettre la plus grande force possible avec un minimum d'effort.

● La poignée octogonale évite que l'outil ne roule sur le plan de travail.

● La nouvelle gamme de manche thermoplastique octroie un confort supérieur à chaque utilisation, même la plus compliquée.

● La nouveauté est la possibilité d'accrocher le tournevis par l'orifice présent sur le manche.



● L'empreinte et la mesure écrite sur la partie sphérique du manche contribuent à une identification rapide.

● L'ergonomie précise du manche permet au tournevis de tourner rapidement entre les doigts.



1201E

Tournevis pour vis à fente



ISO 2380

SxAxL mm	L1 mm	Ø mm	CHF	🔩	📦
0,4x2,5x50	146	2,5	5.15	5	012011003
0,4x2,5x75	166	2,5	5.35	5	012011006
0,5x3x75	171	3,0	5.40	5	012011009
0,5x3x100	196	3,0	5.85	5	012011012
0,6x3,5x75	171	3,5	5.85	5	012011018
0,6x3,5x100	196	3,5	5.95	5	012011021
0,8x4x100	196	4,0	6.00	5	012011030
0,8x4x125	221	4,0	6.35	5	012011033
0,8x4x150	246	4,0	6.80	5	012011036
1,0x5,5x100	209	5,0	7.50	5	012011039
1,0x5,5x125	234	5,0	7.90	5	012011040
1,0x5,5x150	259	5,0	8.00	5	012011042
1,2x6,5x100	220	6,0	8.95	5	012011048
1,2x6,5x125	234	6,0	9.25	5	012011050
1,2x6,5x150	270	6,0	9.45	5	012011051
1,2x8x150	282	8,0	12.20	3	012011057
1,2x8x200	332	8,0	13.00	3	012011060
1,6x10x200	332	9,5	15.10	3	012011066



1201E/S6	CHF	🔩	📦
0,5x3x75-0,6x3,5x100 0,8x4x100-1,0x5,5x100 1,2x8x150-1,6x10x200 mm	52.00	1	012011206

1201EN

Tournevis à lame courte pour vis à fente



ISO 2380

SxAxL mm	L1 mm	Ø mm	CHF	🔩	📦
0,8x4x30	86,5	4	7.30	3	012011103
1,2x6,5x30	86,5	6	7.75	3	012011106

1201E/DZ

Tournevis pour vis Dzus®



L mm	L1 mm	CHF	🔩	📦
53	173	18.00	2	012011501

1202E

Tournevis pour vis Phillips®



UNI-ISO 8764

PHxDxL mm	L1 mm	CHF		
0x3x60	156	5.35	5	012021003
0x3x100	200	5.95	5	012021006
1x4,5x80	189	6.75	5	012021009
1x4,5x120	229	7.70	5	012021012
2x6x100	220	9.25	5	012021018
2x6x150	270	9.90	5	012021021
3x8x150	282	12.70	3	012021024
4x9,5x200	332	16.60	3	012021027



	CHF		
1202E/S4 PH0x3x60-PH1x4,5x120 PH2x6x150-PH3x8x150 mm	35.50	1	012021204

1202EN

Tournevis à lame courte
pour vis Phillips®



UNI-ISO 8764

PHxDxL mm	L1 mm	CHF		
1x4,5x30	86,5	7.30	3	012021103
2x6x30	86,5	7.75	3	012021106

1202EL

Tournevis à lame longue
pour vis Phillips®

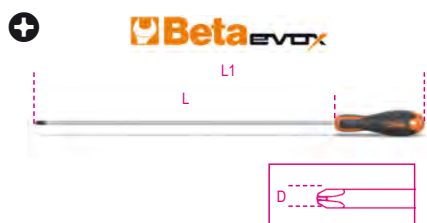

UNI-ISO 8764-1

PHxDxL mm	L1 mm	CHF		
0x3x300	400	9.45	3	012021303
1x4,5x300	400	10.30	3	012021305
1x4,5x400	508	12.50	3	012021306
2x6x400	519	14.40	3	012021309

1203E/D

Jeu de tournevis



	CHF		
1203E/D5 1201E 0,6x3,5x100-1,0x5,5x150 1,2x6,5x150 mm 1202E PH1x4,5x80-PH2x6x100 mm	39.00	1	012031001

	CHF		
1203E/D5PZ 1201E 0,5x3x75-0,8x4x125 1,0x5,5x150 mm 1209E/PZ PZ1x4,5x80-PZ2x6x100 mm	38.00	1	012031003

	CHF		
1203E/D6 1202E PH1x4,5x80-PH2x6x100 mm 1204E 0,4x2,5x60-0,5x3x100 0,8x4x100-1,0x5x125 mm	40.50	1	012031006

	CHF		
1203E/D7 1201E 0,5x3x75-0,8x4x100 1,0x5,5x100-1,2x6,5x150 mm 1202E PH0x3x60-PH1x4,5x80 PH2x6x100 mm	49.50	1	012031007

	CHF		
1203E/D8 1201E 0,5x3x75-0,8x4x125 1,0x5,5x150-1,2x6,5x150 mm 1202E PH0x3x60-PH1x4,5x80 PH2x6x100-PH3x8x150 mm	63.00	1	012031008

	CHF		
1203E/D8P 1201E 2,5x50-3x75-4x100-5,5x100- 6,5x150 mm 1202E PH0x60-PH1x80-PH2x100 mm	54.50	1	012031018

	CHF		
1203E/D10 1201E 0,4x2,5x50-0,5x3x75 0,8x4x100-1,0x5,5x100 1,2x6,5x150-1,2x8x150 mm 1202E PH0x3x60-PH1x4,5x80 PH2x6x100-PH3x8x150 mm	79.50	1	012031010

	CHF		
1203E/D10N 1201E 0,4x2,5x50-0,5x3x75-0,8x4x100- 1,0x5,5x150-1,2x6,5x150 mm 1201EN 0,8x4x30 mm 1202E PH0x3x60-PH1x4,5x80- PH2x6x100 mm 1202EN PH1x4,5x30 mm	70.00	1	012031019



1203E/S



	CHF		
1203E/S8 1201E 2,5x50-3x75-4x100-5,5x125- 6,5x150 mm 1202E PH0x3x60-PH1x4,5x80- PH2x6x100 mm	55.00	1	012031009

	CHF		
1203E/S10 1201E 0,4x2,5x50-0,5x3x75 0,8x4x125-1,0x5,5x150 1,2x6,5x150-1,2x8x150 mm 1202E PH0x3x60-PH1x4,5x80 PH2x6x100-PH3x8x150 mm	80.50	1	012031021

1204E

Tournevis à lame fraisée
pour vis à fente



ISO 2380

SxDxL mm	L1 mm	CHF		
0,4x2,5x60	156	5.25	5	012041003
0,6x3x75	175	5.40	5	012041006
0,5x3x100	196	5.50	5	012041009
0,8x4x100	196	6.20	5	012041012
0,8x4x125	233	6.45	5	012041015
1x5x125	234	7.55	5	012041018
1x5x150	258	8.20	5	012041021
1,2x6,5x150	270	8.95	5	012041024



	CHF		
1204E/S5 0,4x2,5x60-0,5x3x100 0,8x4x100-1x5x125 1,2x6,5x150 mm	33.50	1	012041205

1204EL

Tournevis à lame longue fraisée pour vis à feinte



ISO 2380

SxDxL mm	L1 mm	CHF	🔧	📦
0,5x2,5x200	300	7.75	3	012041303
0,5x3x300	400	9.25	3	012041306
0,8x4x400	508	11.40	3	012041309
1x5x400	508	12.20	3	012041315
1,2x6,5x400	519	15.50	3	012041318

1205E/ES



mm	L mm	L1 mm	CHF	🔧	📦
1,5	100	200	6.60	3	012051315
2	100	200	6.75	3	012051320
2,5	100	200	6.80	3	012051325
3	100	200	7.05	3	012051330
4	100	208	8.15	3	012051340
5	100	219	9.75	3	012051350
6	125	244	10.00	3	012051360
8	150	277	13.30	2	012051380



1205E/ES-S8	CHF	🔧	📦
1,5-2-2,5-3-4-5-6-8 mm	68.00	1	012051408

1206E/BP

Clé mâle emmanchée à tête sphérique pour vis 6 pans



mm	L mm	L1 mm	Ø mm	CHF	🔧	📦
2	100	198	2,5	7.40	3	012061320
2,5	100	198	3,0	7.50	3	012061325
3	100	198	3,5	7.65	3	012061330
4	100	209	5,0	8.55	3	012061340
5	100	220	6,0	10.30	3	012061350
6	125	245	7,0	10.60	3	012061360
8	150	287	9,5	14.10	2	012061380



1206E/BP-S7	CHF	🔧	📦
2-2,5-3-4-5-6-8 mm	66.50	1	012061407

1207E/TX

Tournevis pour vis Torx®



	L mm	L1 mm	Ø mm	CHF	🔧	📦
T5	50	150	3	7.90	5	012071005
T6	60	156	4	8.35	5	012071006
T7	60	156	4	8.55	5	012071007
T8	60	156	4	8.70	5	012071008
T9	60	156	4	9.10	5	012071009
T10	80	189	5	10.30	5	012071010
T15	80	189	5	10.40	5	012071015
T20	100	209	5	10.60	5	012071020
T25	100	209	5	10.90	5	012071025
T27	100	220	6	11.60	5	012071027
T30	100	220	6	11.70	5	012071030
T40	130	262	7	13.90	2	012071040
T45	130	262	8	15.30	2	012071045



1207E/TX-D7	CHF	🔧	📦
T6-T8-T10-T15 T20-T25-T30	70.50	1	012071207
1207E/TX-D13	CHF	🔧	📦
T5-T6-T7-T8-T9-T10-T15 T20-T25-T27-T30-T40-T45	137.00	1	012071213

1208E/RTX

Tournevis pour vis Tamper Resistant Torx®



	L mm	L1 mm	Ø mm	CHF	🔧	📦
T9	60	156	4	9.25	5	012081009
T10	80	189	5	10.30	5	012081010
T15	80	189	5	10.90	5	012081015
T20	100	209	5	11.10	5	012081020
T25	100	209	5	11.40	5	012081025
T27	100	220	6	12.30	5	012081027
T30	100	220	6	12.90	5	012081030
T40	130	262	7	15.40	2	012081040

Beta EVOLX



1208E/RTX-D7	CHF	🔧	📦
T9-T10-T15-T20 T25-T27-T30	78.00	1	012081207

1209E/PZ

Tournevis pour vis Pozidriv®-Supadriv®



UNI-ISO 8764

PZ	L mm	L1 mm	CHF	🔧	📦
0	60	156	6.20	5	012091000
1	80	189	8.00	5	012091003
2	100	220	10.30	5	012091006
3	150	282	15.80	3	012091009
4	200	327	17.20	3	012091012



1209E/PZ-S4	CHF	🔧	📦
PZ0-PZ1-PZ2-PZ3	40.50	1	012091204

1209EN/PZ

Tournevis à lame courte pour vis Pozidriv®-Supadriv®



ISO 8764

PZ	L mm	L1 mm	CHF	🔧	📦
1	30	87	7.30	3	012091103
2	30	87	7.75	3	012091106



1229LP

Micro-tournevis pour vis à fente

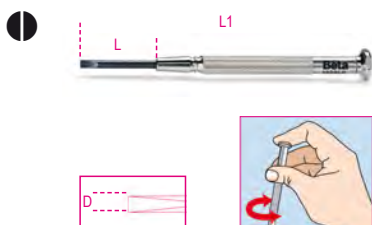

D mm	L mm	L1 mm	CHF		
1,0	17	75	5.50	5	012290210
1,2	21	85	5.50	5	012290212
1,4	21	89	5.50	5	012290214
1,8	23	94	5.50	5	012290218
2,0	23	98	5.50	5	012290220
2,4	26	103	5.50	5	012290224
3,0	28	108	6.60	5	012290230



1229LP/A6	CHF		
1,2-1,4-1,8-2-2,4-3 mm	33.00	1	012290300

1229PH

Micro-tournevis pour vis Phillips®

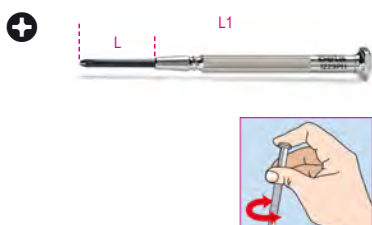

PH	L mm	L1 mm	CHF		
0	26	102	6.10	5	012290250
1	29	107	6.45	5	012290251

1229LPH/A6

Jeu de 6 micro-tournevis 1229LP-1229PH



1229LPH/A6	CHF		
1229LP 1,4-2,0-2,4-3 mm	33.00	1	012290310
1229PH PH0-PH1			

1236B

Tournevis coudé pour vis à fente

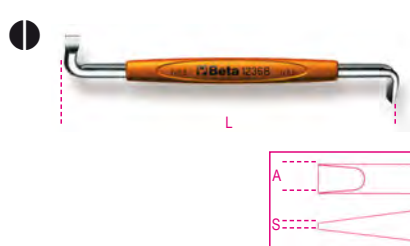

UNI 7079 DIN 5200

SxA mm	L mm	CHF		
0,8x4	100	9.35	5	012360201
1x5,5	125	10.90	5	012360202
1,2x8	150	13.50	5	012360204

1238B

Tournevis coudé pour vis Phillips®



UNI 7083 DIN 5208

PH	L mm	CHF		
1-2	125	11.10	5	012380201
3-4	200	18.10	5	012380203

1241

Tournevis à zone de frappe pour vis à fente



ISO 2380

SxAxL mm	L1 mm	CHF		
1x5,5x100	202	14.60	5	012410039
1,2x6,5x125	240	16.30	5	012410050
1,2x8x150	268	19.80	3	012410057
1,6X10x175	300	24.80	2	012410065
1,6x10x200	325	25.50	2	012410066
2,0X12x200	325	26.50	2	012410067
2,5X14X250	375	29.00	2	012410076



1242

Tournevis avec tête en acier pour vis Phillips®



UNI/ISO 8764

PHxDxL mm	L1 mm	CHF		
1x4,5x100	202	14.40	5	012420209
2x6x100	215	17.10	5	012420218
3x8x150	268	21.80	3	012420221
4x11x200	325	28.50	2	012420224

1243LP/D6

Jeu de 6 tournevis à zone de frappe pour vis à fente



1243LP/D6	CHF		
1241 1x5,5x100-1,2x6,5x125-3x8x150-1,6x10x175-2,0x12x200-2,5x14x250 mm	131.50	1	012430016

1243/D7

Jeu de 7 tournevis à zone de frappe



1243/D7	CHF		
1241 1x5,5x100-1,2x6,5x125-1,2x8x150-1,6x10x200 mm	129.50	1	012430017
1242 PH1x4,5x100-PH2x6x100-PH3x8x150 mm			

1243/S11

Jeu de 11 tournevis à zone de frappe



1243/S11 CHF 238.50 1 012430021

1241	1x5,5x100-1,2x6,5x125-3x8x150-1,6x10x175-1,6x10x200-2,0x12x200-2,5x14x250 mm
1242	PH1x4,5x100-PH2x6x100-PH3x8x150-PH4x11x200 mm

1250

Tournevis pose-vis à fente

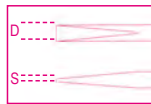

SxDxL mm	L1 mm	CHF	5	1
0,5x3x125	190	20.80	5	012500030
0,6x4x125	225	22.50	5	012500040
0,7x5x150	255	26.50	5	012500050

1251

Tournevis pose-vis Phillips®



PHxDxL mm	L1 mm	CHF	5	1
0x4x125	225	23.40	5	012510000
1x5x125	225	27.00	5	012510010
2x6x175	280	31.00	5	012510020

1252/S5



1252/S5 CHF 127.50 1 012520001

1250	0,5x3x125-0,6x4x125-0,7x5x150 mm
1251	PH1x5x150-PH2x6x175 mm

1253

Tournevis détecteur de tension 150/250V



SxAxL mm	L1 mm	CHF	5	1
0,5x3,5x100	190	12.50	5	012530001

1253A

Tournevis détecteur de tension 125/250V à double isolation

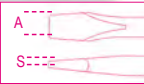

SxAxL mm	L1 mm	CHF	5	1
0,5x3x15	150	8.85	5	012530010

1254

Tournevis détecteur de tension à pince crocodile 6/24 V



SxAxL mm	L1 mm	CHF	5	1
0,5x3x44	123	13.80	5	012540001

1256/C36-2

Micro-tournevis avec 36 embouts interchangeables de 4 mm et rallonge magnétique



1256/C36-2 CHF 88.50 1 012560100

1256TX	T3 - T4 - T5 - T6 - T7 - T8 - T9 - T10 - T15
1256RTX	T6 - T7 - T8 - T9 - T10
1256LP	0,8 - 1,2 - 1,5 - 1,8 - 2 - 2,5 - 3 - 3,5 - 4 mm
1256PE	0,7 - 0,9 - 1,3 - 1,5 - 2 mm
1256PH	PH000 - PH00 - PH0 - PH1
1256PZ	PZ000 - PZ00 - PZ0 - PZ1
1256/20	
1256/30	

130x60x35 mm - 200 g

1256LP

Embout 4 mm pour vis à fente

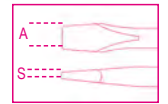

SxA mm	L mm	CHF	5	1
0.25x0.8	27	1.73	5	012560001
0.25x1.2	27	1.73	5	012560002
0.3x1.5	27	1.73	5	012560003
0.35x1.8	27	1.73	5	012560004
0.4x2.0	27	1.73	5	012560005
0.4x2.5	27	1.73	5	012560006
0.5x3.0	27	1.73	5	012560007
0.6x3.5	27	1.73	5	012560008
0.8x4.0	27	1.73	5	012560009

1256PH

Embout 4 mm pour vis Phillips®



PH	L mm	CHF	5	1
000	27	1.73	5	012560011
00	27	1.73	5	012560012
0	27	1.73	5	012560013
1	27	1.73	5	012560014

1256PZ

Embout 4 mm pour vis Pozidriv® - Supradriv®



PZ	L mm	CHF	5	1
000	27	1.73	5	012560061
00	27	1.73	5	012560062
0	27	1.73	5	012560063
1	27	1.73	5	012560064

1256PE

Embout 4 mm pour vis 6 pans



mm	L mm	CHF	5	1
0.7	27	1.73	5	012560021
0.9	27	1.73	5	012560022
1.3	27	1.73	5	012560023
1.5	27	1.73	5	012560024
2.0	27	1.73	5	012560025

1256TX

Embout 4 mm
pour vis Torx®



Ø	L mm	CHF	🔧	📦
T3	27	1.80	5	012560041
T4	27	1.80	5	012560042
T5	27	1.80	5	012560043
T6	27	1.80	5	012560044
T7	27	1.80	5	012560045
T8	27	1.80	5	012560046
T9	27	1.80	5	012560047
T10	27	1.80	5	012560048
T15	27	1.80	5	012560049

1256RTX

Embout 4 mm
pour vis à Tamper Resistant Torx®



Ø	L mm	CHF	🔧	📦
T6	27	2.15	5	012560051
T7	27	2.15	5	012560052
T8	27	2.15	5	012560053
T9	27	2.15	5	012560054
T10	27	2.15	5	012560055

1256/20

Rallonge avec entraînements hexagonaux
mâle et femelle de 4 mm



	CHF	🔧	📦
1256/20	10.80	5	012560092

1256/30

Poignée porte-embouts de 4 mm



L mm	CHF	🔧	📦
110	12.80	2	012560097

1257LP

Micro-tournevis pour vis à fente

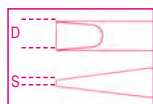

SxD mm	L mm	CHF	🔧	📦
0,25x1,2	60	6.80	5	012570012
0,23x1,5	60	6.80	5	012570015
0,3x1,8	60	6.80	5	012570018
0,4x2	60	6.80	5	012570020
0,4x2,5	60	6.80	5	012570024
0,5x3	60	6.80	5	012570030
0,6x3,5	60	6.80	5	012570035
0,8x4	60	6.80	5	012570040



1257LP/S8	CHF	🔧	📦
0,2x1,2-0,25x1,5 0,3x1,8-0,4x2-0,4x2,5 0,5x3-0,6x3,5-0,8x4 mm	85.50	1	012570200

1257PH

Micro-tournevis pour vis Phillips®



PH	L mm	CHF	🔧	📦
00	60	6.80	5	012570060
0	60	6.80	5	012570063
1	60	6.80	5	012570066

1257LPH/S8

Coffret de 8 micro-tournevis (art. 1257LP,
1257PH) en coffret



1257LPH/S8	CHF	🔧	📦
1257PH PH00-PH0-PH1 1257LP 0,4x2-0,4x2,5-0,5x3 0,6x3,5-0,8x4 mm	85.50	1	012570210

1257ES

Micro-clé mâle emmanchée
pour vis 6 pans



mm	L mm	CHF	🔧	📦
0,9	60	7.70	5	012570045
1,3	60	7.70	5	012570046
1,5	60	7.70	5	012570047
2	60	7.70	5	012570048
2,5	60	7.70	5	012570049
3	60	7.70	5	012570050

1257ESB/S8

Coffret de 8 micro-tournevis (art. 1257ES,
1257BE) en coffret



1257ESB/S8	CHF	🔧	📦
1257ES 0,9-1,3-1,5-2-2,5-3 mm 1257BE 4-5 mm	97.50	1	012570230

1257TX

Micro-tournevis pour vis Torx®



Ø	L mm	CHF	🔧	📦
T5	60	8.15	5	012570075
T6	60	8.15	5	012570076
T7	60	8.15	5	012570077
T8	60	8.15	5	012570078
T9	60	8.15	5	012570079
T10	60	8.15	5	012570080
T15	60	8.15	5	012570081
T20	60	8.15	5	012570082



1257TX/S8	CHF	🔧	📦
T5-T6-T7-T8 T9-T10-T15-T20	96.00	1	012570220

1257BE

Micro-clé à douille emmanchée



Ø mm	L mm	CHF	🔧	📦
3,2	60	10.20	5	012570085
4	60	10.20	5	012570086
5	60	10.20	5	012570087
5,5	60	10.20	5	012570088

Les tournevis BetaGrip sont le fruit de la longue expertise de Beta dans la conception des tournevis et d'une étroite collaboration avec les mécaniciens des équipes de course automobile. De nouvelles solutions techniques uniques, capables de satisfaire les exigences des professionnels les plus exigeants, ont été utilisées dans le but d'atteindre les plus hauts standards en matière d'ergonomie, de résistance et de qualité des matériaux.

- La **lame** est en acier spécial à haute teneur en silicium, chrome et vanadium, pour garantir des performances améliorées en termes de résistance à la torsion et à la flexion. Une finition chromée mate antireflet a été choisie.
- La **géométrie de la pointe** a été conçue pour assurer un couplage parfait entre la lame et la tête de vis. La finition phosphatée empêche la pointe de s'oxyder, tout en conservant des profils précis.
- La **matière antidérapante** a été inspirée des bandes de roulement des pneus Racing, développées pour maximiser l'adhérence sur différents terrains. Par conséquent, il garantit un maintien efficace du tournevis dans toutes les conditions de travail, pour une précision et un contrôle améliorés lors du vissage.



1260

Tournevis pour vis à fente



ISO 2380

SxAxL mm	L1 mm	Ø mm	CHF	🔧	📦
0,4x2,5x50	150	2,5	7.00	5	012600003
0,4x2,5x75	175	2,5	7.30	5	012600006
0,5x3x75	175	3,0	7.50	5	012600009
0,5x3x100	200	3,0	7.75	5	012600012
0,6x3,5x75	175	3,5	8.00	5	012600018
0,6x3,5x100	200	3,5	8.15	5	012600021
0,8x4x100	208	4,0	8.85	5	012600030
0,8x4x125	233	4,0	9.25	5	012600033
0,8x4x150	258	4,0	9.60	5	012600036
1x5,5x100	208	5,0	10.20	5	012600039
1x5,5x125	233	5,0	10.40	5	012600040
1x5,5x150	258	5,0	11.30	5	012600042
1,2x6,5x100	219	6,0	12.20	5	012600048
1,2x6,5x125	244	6,0	12.70	5	012600050
1,2x6,5x150	269	6,0	13.20	5	012600051
1,2x8x150	277	8,0	16.10	3	012600057
1,2x8x200	327	8,0	16.60	3	012600060
1,6x10x200	327	9,5	20.20	3	012600066
2x12x250	377	10	23.90	3	012600069
2x14x250	377	10	25.50	2	012600073



1260/S6	CHF	🔧	📦
0,4x2,5x75-0,5x3x75-0,8x4x125 1x5,5x150-1,2x6,5x150-1,2x8x200 mm	65.00	1	012600306

1260N

Tournevis à lame courte pour vis à fente



ISO 2380

SxAxL mm	L1 mm	Ø mm	CHF	🔧	📦
0,8x4x30	87	4	9.35	5	012600103
1,2x6,5x30	87	6	10.40	5	012600106

1260E

Tournevis 6 pans pour vis à fente



ISO 2380

SxAxL mm	L1 mm	Ø mm	CHF		
1,2x6,5x150	269	6,0	17.10	3	012600156
1,2x8x175	301	8,0	21.00	3	012600157
1,6x10x200	327	9,5	24.30	2	012600159
2x12x250	377	9,5	28.00	2	012600162

1260MC

tournevis pour vis à fente, avec repère de couleur



SxAxL mm	L1 mm	Ø mm	CHF		
0,4x2,5x50	150	2,5	7.65	3	012602003
0,6x3,5x75	175	3,5	7.90	3	012602018
0,8x4x100	208	4,0	9.35	3	012602030
1x5,5x125	233	5,0	12.00	5	012602040
1,2x6,5x150	269	6,0	13.80	5	012602051

1262

Tournevis pour vis Phillips®



UNI/ISO 8764

PHxDxL mm	L1 mm	CHF		
0x3x60	160	7.50	5	012620003
0x3x100	200	7.95	5	012620006
1x4,5x80	188	9.85	5	012620009
1x4,5x120	228	10.70	5	012620012
2x6x100	219	12.10	5	012620018
2x6x150	269	13.30	5	012620021
3x8x150	277	17.90	3	012620024
4x10x200	327	22.70	3	012620027



1262/S4	CHF		
PH0x3x60-PH1x4,5x80 PH2x6x100-PH3x8x150 mm	47.00	1	012620304

1262N

Tournevis à lame courte pour vis Phillips®



UNI/ISO 8764

PHxDxL mm	L1 mm	CHF		
1x4,5x30	87	9.35	5	012620103
2x6x30	87	10.40	5	012620106

1262E

Tournevis 6 pans pour vis Phillips®



UNI/ISO 8764

PHxDxL mm	L1 mm	CHF		
2x6x150	269	17.10	3	012620153
3x8x175	302	20.70	3	012620156
4x10x200	327	26.00	2	012620159

1262L

Tournevis à lame longue pour vis Phillips®



UNI/ISO 8764-1

PHxDxL mm	L1 mm	CHF		
0x3x300	400	12.90	3	012620203
1x4,5x300	400	15.50	3	012620205
1x4,5x400	508	18.00	3	012620206
2x6x400	519	23.40	3	012620209

1262MC

tournevis pour vis cruciformes Phillips®, avec repère de couleur



PHxDxL mm	L1 mm	CHF		
0x3x60	160	7.90	3	012622003
1x4,5x80	188	10.20	3	012622009
2x6x100	219	12.70	3	012622018

1263/D...

Jeu de tournevis



1263/D6	CHF		
1260 0,5x3x75-0,8x4x100 1x5,5x125-1,2x6,5x150 mm	62.00	1	012630006
1262 PH1x4,5x80-PH2x6x100 mm			



1263/D7	CHF		
1262 PH0x3x60 PH1x4,5x80 PH2x6x100 mm	64.00	1	012630017
1264 0,5x2,5x60-0,6x3x100 0,8x4x125-1x5x125 mm			



1263/D7PZ	CHF		
1260 0,5x3x75-0,8x4x100 1x5,5x150-1,2x6,5x150 mm	73.50	1	012630007
1269PZ PZ0 - PZ1 - PZZ			



1263/D8	CHF		
1260 0,4x2,5x50-0,5x3x75 0,8x4x100-1x5,5x125 1,2x6,5x150 mm	76.00	1	012630008
1262 PH0x3x60-PH1x4,5x80 PH2x6x100 mm			



1263/D10	CHF		
1260 0,5x3x75-0,6x3,5x100 0,8x4x125-1x5,5x150 1,2x6,5x150 mm	97.50	1	012630010
1260N 0,8x4x30			
1262 PH0x3x60-PH1x4,5x80 PH2x6x100 mm			
1262N PH1x4,5x30			

1263/S12

Jeu de 12 tournevis



1263/S12 CHF 139.50 1 012630112

1260	0,4x2,5x50-0,5x3x75 0,6x3,5x100-0,8x4x125 1x5,5x125-1,2x6,5x150 1,2x8x200-1,6x10x200 mm
1262	PH0x3x60-PH1x4,5x80 PH2x6x100-PH3x8x150 mm

1263MC/D8

Jeu de 8 tournevis colorés



1263MC/D8 CHF 81.00 1 012632008

1260MC	0,4x2,5x50-0,5x3x75 0,8x4x100-1x5,5x125 1,2x6,5x150 mm
1262MC	PH0x3x60-PH1x4,5x80 PH2x6x100 mm

1264

Tournevis à lame fraisée pour vis à fente

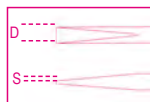

SxDxL mm	L1 mm	CHF	Icons
0,5x2,5x60	160	7.00	5 012640003
0,6x3x75	175	7.50	5 012640006
0,6x3x100	200	7.75	5 012640009
0,8x4x100	208	8.85	5 012640012
0,8x4x125	233	9.25	5 012640015
1x5x125	233	10.40	5 012640018
1x5x150	258	10.90	5 012640021
1,2x6,5x150	269	13.20	5 012640024



1264/S5 CHF 47.00 1 012640305
0,5x2,5x60-0,6x3x75
0,8x4x100-1x5x125-1,2x6,5x150 mm

1264L

Tournevis à lame longue fraisée pour vis à fente



SxDxL mm	L1 mm	CHF	Icons
0,5x2,5x200	300	10.50	3 012640203
0,6x3x300	400	12.30	3 012640206
0,8x4x400	508	16.10	3 012640209
1x5x400	508	18.00	3 012640215
1,2x6,5x400	519	21.80	3 012640218

1265ES

Clé mâle emmanchée pour vis 6 pans



mm	L mm	L1 mm	CHF	Icons
1,5	100	200	8.60	3 012650015
2	100	200	8.80	3 012650020
2,5	100	200	9.10	3 012650025
3	100	200	9.60	3 012650030
4	100	208	10.50	3 012650040
5	100	219	12.20	3 012650050
6	125	244	13.80	3 012650060
8	150	277	18.40	2 012650080



1265ES/S8 CHF 91.00 1 012650308
1,5-2-2,5-3-4-5-6-8 mm

1266BP

Clé mâle emmanchée à tête sphérique pour vis 6 pans



mm	L mm	L1 mm	CHF	Icons
2	100	200	9.35	3 012660020
2,5	100	200	9.75	3 012660025
3	125	225	10.20	3 012660030
4	125	233	11.30	3 012660040
5	120	239	13.20	3 012660050
6	140	259	15.30	3 012660060
8	160	287	19.20	2 012660080
10	160	287	23.10	2 012660100



1266BP/S8 CHF 111.00 1 012660308
2-2,5-3-4-5-6-8-10 mm

1267TX

Tournevis pour vis Torx®



Ø	L mm	L1 mm	Ø mm	CHF	Icons
T5	50	150	3	10.50	5 012670005
T6	50	150	3	10.90	5 012670006
T7	50	150	3	11.30	5 012670007
T8	60	160	3	11.90	5 012670008
T9	60	167	4	12.30	5 012670009
T10	80	188	4	12.80	5 012670010
T15	80	188	4	13.50	5 012670015
T20	100	208	4,5	14.30	5 012670020
T25	100	208	5	15.50	5 012670025
T27	115	234	6	16.10	5 012670027
T30	115	234	6	17.00	5 012670030
T40	130	257	7	19.70	2 012670040
T45	130	257	8	21.60	2 012670045



1267TX/D7
T6-T8-T10-T15
T20-T25-T30

CHF 95.50 1 012670307



1267TX/S13
T5-T6-T7-T8-T9
T10-T15-T20-T25
T27-T30-T40-T45

CHF 187.00 1 012670312

1267MC/TX

tournevis pour vis à tête Torx®, avec repère de couleur



	L mm	L1 mm	Ø mm	CHF		
T6	50	150	3	11.50	5	012672006
T8	60	160	3	12.20	5	012672008
T10	80	188	4	13.40	5	012672010
T15	80	188	4	14.30	5	012672015
T20	100	208	4,5	15.30	5	012672020
T25	100	208	5	16.00	3	012672025
T30	115	234	6	17.60	3	012672030



1267MC/TX-D7
T6-T8-T10-T15
T20-T25-T30

CHF 100.50 1 012672307

1268RTX

Tournevis pour vis Tamper Resistant Torx®



	L mm	L1 mm	Ø mm	CHF		
T9	60	167	4,0	13.40	3	012680009
T10	80	188	4,0	13.90	3	012680010
T15	80	188	4,0	14.30	3	012680015
T20	100	208	4,5	15.50	3	012680020
T25	100	208	5,0	15.90	3	012680025
T27	115	234	6,0	17.00	3	012680027
T30	115	234	6,0	17.20	3	012680030
T40	130	257	7,0	20.00	2	012680040



1268RTX/S8
T9-T10-T15-T20
T25-T27-T30-T40

CHF 127.00 1 012680307

1269PZ

Tournevis pour vis Pozidriv®-Supadriv®



UNI/ISO 8764

PZ	L mm	L1 mm	CHF		
0	60	160	8.55	5	012690000
1	80	188	11.10	5	012690001
2	100	219	13.40	5	012690002
3	150	277	19.20	3	012690003
4	200	327	24.60	3	012690004



1269PZ/S4
PZ0-PZ1-PZ2-PZ3

CHF 52.00 1 012690304

1269N/PZ

Tournevis à lame courte pour vis Pozidriv®-Supadriv®



UNI/ISO 8764

PZ	L mm	L1 mm	CHF		
1	30	87	9.35	5	012690011
2	30	87	10.40	5	012690012

1281BG

Poignée porte-lames



L mm	Ø mm	CHF		
118	10	15.80	5	012810280

1281PM

Porte-embouts magnétique



L mm	CHF		
165	27.00	5	012810292

1281PB

Porte-douilles carré 1/4"



L mm	CHF		
175	21.50	5	012810293

1281LP

Lame réversible pour vis à fente



	CHF		
1281LP/1 0,8x4-1,2x6,5 mm	13.80	5	012810302
1281LP/2 1x5,5-1,2x6,5 mm	13.80	5	012810304

1281PH

Lame réversible pour vis Phillips®

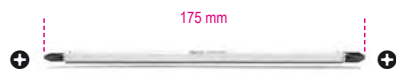

	CHF		
PH 1-2	13.80	5	012810310
2-3	13.80	5	012810312

1281LPH

Lame réversible pour vis à fente et Phillips®



	CHF		
1281LPH/1 PH0-0,8x4 mm	13.80	5	012810321
1281LPH/2 PH1-1x5,5 mm	13.80	5	012810322
1281LPH/3 PH2-1,2x6,5 mm	13.80	5	012810323

1281PZ

Lame réversible pour vis Pozidriv®-Supadriv®



	CHF		
PZ 1-2	13.80	5	012810330
2-3	13.80	5	012810332

1281PE

Lame réversible pour vis à empreinte 6 pans



mm	CHF		
2,5	13.50	5	012810342
3	13.50	5	012810343
4	13.50	5	012810344
5	13.50	5	012810345
6	13.50	5	012810346

1281TX

Lame réversible pour vis Torx®



	CHF		
1281TX/1 T6-T8	15.10	5	012810349
1281TX/2 T7-T9	15.10	5	012810350
1281TX/3 T10-T15	15.10	5	012810351
1281TX/4 T20-T25	15.10	5	012810352
1281TX/5 T30-T40	15.10	5	012810353

1281RTX

Lame réversible pour vis Tamper Resistant Torx®



	CHF		
1281RTX/3 T10-T15	15.40	5	012810361
1281RTX/4 T20-T25	15.40	5	012810362
1281RTX/5 T30-T40	15.40	5	012810363

1281BG/A9

Jeu de 9 lames réversibles et 1 accessoire en étui



	CHF		
1281BG/A9	160.00	1	012810520

1281BG		
1281LPH/1	PH0-0,8x4 mm	
1281LPH/2	PH1-1x5,5 mm	
1281LPH/3	PH2-1,2x6,5 mm	
1281PZ/1	PZ1-PZ2	
1281PE	2,5 mm	
1281PE	3 mm	
1281PE	4 mm	
1281PE	5 mm	
1281PE	6 mm	

1281BG-TX/A8

Jeu de 8 lames réversibles et 1 accessoire en étui



	CHF		
1281BG-TX/A8	154.50	1	012810530

1281BG		
1281LPH/1	PH0-0,8x4 mm	
1281LPH/2	PH1-1x5,5 mm	
1281LPH/3	PH2-1,2x6,5 mm	
1281TX/1	T6-T8	
1281TX/2	T7-T9	
1281TX/3	T10-T15	
1281TX/4	T20-T25	
1281TX/5	T30-T40	

1281BG/B28NA

assortiment de 16 lames réversibles, 9 douilles 1/4 », 2 accessoires et 1 poignée, dans un trousseau en polyester durable



	CHF		
1281BG/B28NA	357.00	1	012810511

900	4 - 4,5 - 5 - 5,5 6 - 7 - 8 - 9 - 10 mm	
1281BG		
1281PB	■ 1/4	
900/25		
1281LP/1	0,8x4 - 1,2x6,5 mm	
1281LP/2	1,0x5,5 - 1,2x6,5 mm	
1281PH/1	PH1 - PH2	
1281PH/2	PH2 - PH3	
1281PZ/1	PZ1 - PZ2	
1281PZ/2	PZ2 - PZ3	
1281PE	2,5 - 3 - 4 - 5 - 6 mm	
1281TX/1	T6 - T8	
1281TX/2	T7 - T9	
1281RTX/3	T10 - T15	
1281RTX/4	T20 - T25	
1281RTX/5	T30 - T40	

	CHF		
2002/BV7-ZIP	26.00	1	020020060

Les tournevis BetaMax s'appuient sur plusieurs caractéristiques techniques pour rendre les opérations de travail encore plus faciles.

- La poignée s'inspire de la section triangulaire, qui assure un vissage optimal, basé sur une plage de 120°, en ligne avec une rotation maximale du poignet.
- La conception offre des propriétés ergonomiques remarquables, à la fois lors des opérations de vissage et de serrage rapides.
- La pointe sans chromage assure un couplage parfait avec la vis et est protégée de l'oxydation par un traitement phosphaté.

1290

Tournevis pour vis à fente



ISO 2380

SxAxL mm	L1 mm	Ø mm	CHF		
0,4x2,5x50	146	2,5	8.80	5	012900003
0,4x2,5x75	171	2,5	9.10	5	012900006
0,5x3x75	171	3,0	9.30	10	012900009
0,5x3x100	196	3,0	9.80	10	012900012
0,6x3,5x75	171	3,5	10.50	10	012900018
0,6x3,5x100	196	3,5	10.70	10	012900021
0,8x4x100	196	4,0	10.90	10	012900030
0,8x4x125	221	4,0	11.20	10	012900033
0,8x4x150	246	4,0	11.90	10	012900036
1x5,5x100	209	5,0	12.20	10	012900039
1x5,5x150	259	5,0	13.50	10	012900042
1,2x6,5x100	220	6,0	15.10	10	012900048
1,2x6,5x150	270	6,0	16.00	10	012900051
1,2x8x150	282	7,0	20.10	3	012900057
1,2x8x200	332	7,0	21.20	3	012900060
1,6x10x200	332	8,0	24.90	3	012900066
2x12x250	382	10	33.50	2	012900069

1290/S

Jeu de tournevis



	CHF		
1290/S5	69.50	1	012900305
1290			0,5x3x75-0,8x4x100 -1x5,5x150 1,2x6,5x150 -1,2x8x150 mm

	CHF		
1290/S9X	131.00	1	012900319
1290			0,4x2,5x75 - 0,5x3,5x100 0,8x4x125 - 1x5,5x150 1,2x6,5x150 - 1,2x8x200 1,6x10x200 mm
1290N			0,8x4x30 -1,2x6,5x30 mm

1290N

Tournevis à lame courte pour vis à fente



ISO 2380

SxAxL mm	L1 mm	Ø mm	CHF		
0,8x4x30	86	4	11.50	5	012900103
1,2x6,5x30	86	6	12.80	5	012900106

1292

Tournevis pour vis Phillips®



UNI/ISO 8764

PHxDxL mm	L1 mm	CHF		
0x3x60	156	8.45	10	012920003
0x3x100	196	9.60	5	012920006
1x4,5x80	189	11.60	10	012920009
1x4,5x120	229	12.90	10	012920012
2x6x100	220	15.40	10	012920018
2x6x150	270	16.50	10	012920021
3x8x150	282	21.00	3	012920024
4x10x200	332	29.00	3	012920027



	CHF		
1292/S4	56.50	1	012920304
			PH0x3x60-PH1x4,5x80 PH2x6x100-PH3x8x150 mm

1292N

Tournevis à lame courte pour vis Phillips®



UNI/ISO 8764

PHxDxL mm	L1 mm	CHF		
1x4,5x30	86	11.00	5	012920103
2x6x30	86	12.00	5	012920106

1292L

Tournevis à lame longue pour vis à empreinte Phillips®



UNI/ISO 8764-1

PHxDxL mm	L1 mm	CHF		
0x3x300	396	18.70	3	012920203
1x4,5x400	509	23.20	3	012920206
2x6x400	520	28.50	3	012920209



1293/D...

Jeu de tournevis



1293/D6 CHF 75.50 1 012930401

1290 0,6x3,5x75-1x5,5x150
1,2x6,5x150 mm
1292 PH0x3x60 -PH1x4,5x80
PH2x6x100 mm

1293/D8 CHF 105.50 1 012930403

1290 0,5x3x75-0,8x4x100
1x5,5x150-1,2x6,5x150
1,2x8x150 mm
1292 PH0x3x60 -PH1x4,5x80
PH2x6x100 mm

1293/S...

Jeu de tournevis



1293/S8 CHF 93.50 1 012930208

1290 2,5x50-3x75-4x100-5,5x150
6,5x150 mm
1292 PH0x3x60 -PH1x4,5x80
PH2x6x100 mm

1293/S10 CHF 149.00 1 012930201

1290 0,4x2,5x50 -0,6x3,5x100
1x5,5x100-1,2x6,5x150
1,2x8x150-1,6x10x200 mm
1292 PH0x3x60 -PH1x4,5x80
PH2x6x100-PH3x8x150 mm

1293/S12 CHF 162.00 1 012930203

1290 0,5x3x75-0,8x4x125
1x5,5x150-1,2x6,5x150
1,2x8x200 mm
1290N 0,8x4x30 mm
1292 PH0x3x60 -PH1x4,5x80
PH2x6x100-PH3x8x150 mm
1292N PH1x4,5x30-PH2x6x30 mm

1293/S7 CHF 77.00 1 012930207

1292 PH0x3x60 -PH1x4,5x80
PH2x6x100 mm
1294 0,5x2,5x60-0,6x3x75
0,8x4x100-1x5x125 mm



1293ES

Clé mâle emmanchée pour vis 6 pans

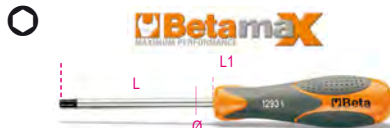

mm	L mm	L1 mm	Ø mm	CHF	1	012930001
2	100	196	3	11.90	5	012930001
2,5	100	196	4	11.90	5	012930002
3	100	196	4	12.30	5	012930003
4	100	196	5	13.90	5	012930004
5	100	209	6	15.40	5	012930005
6	125	245	7	17.40	5	012930006
8	150	282	10	23.20	2	012930008



1293ES/S7 CHF 106.00 1 012930057
2-2,5-3-4-5-6-8 mm

1293BP

Clé mâle emmanchée à tête sphérique pour vis 6 pans



mm	L mm	L1 mm	CHF	5	012930501
2	100	196	12.00	5	012930501
2,5	100	196	12.00	5	012930502
3	100	196	12.40	5	012930503
4	100	196	13.90	5	012930506
5	100	209	15.40	5	012930509
6	125	245	17.70	5	012930512
8	150	282	24.20	2	012930515



1293BP/S7 CHF 108.00 1 012930558
2-2,5-3-4-5-6-8 mm

1294

Tournevis à lame fraisée pour vis à fente



SxDxL mm	L1 mm	CHF	5	012940003
0,5x2,5x60	156	8.25	5	012940003
0,6x3x75	171	8.70	5	012940006
0,6x3x100	196	8.95	5	012940009
0,8x4x100	196	10.90	5	012940012
0,8x4x150	246	14.10	5	012940015
1x5x125	234	13.60	5	012940018
1,2x6,5x150	282	16.10	5	012940027



1294/S5 CHF 57.50 1 012940305
0,5x2,5x60-0,6x3x100
0,8x4x100-1x5x125
1,2x6,5x150 mm

1294L

Tournevis à lame longue fraisée pour vis à fente

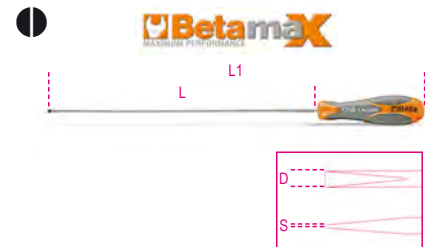

SxDxL mm	L1 mm	CHF	3	012940206
0,6x3x300	396	18.00	3	012940206
0,8x4x400	496	21.20	3	012940209
1x5x400	509	26.00	3	012940215
1,2x6,5x400	532	29.00	3	012940218

1295

Tournevis à frapper



1295 L mm 130 CHF 78.50 1 012950001



1295/C14

Tournevis à frapper
avec 14 embouts et 1 douille porte-embouts



1295/C14 **CHF 186.50** 1 012950108

	866LP	1,2x6,5 - 1,6x10 mm
	866PH	PH2 - PH3
	866PZ	PZ2 - PZ3
	866PE	5 - 6 mm
	866TX	T27 - T30 - T40 - T45 - T50 - T55
	895/6	□ 1/2 - ○ 5/16
	1295	■ 1/2

170x100x35 mm - 1,3 kg

1297TX

Tournevis pour vis Torx®



Ø	L mm	L1 mm	Ø mm	CHF	5	1
T6	50	146	3,0	15.60	5	012970006
T7	50	146	3,0	15.90	5	012970007
T8	60	156	3,0	16.00	5	012970008
T9	60	169	4,0	16.60	5	012970009
T10	80	189	4,0	17.60	5	012970010
T15	80	189	4,0	17.70	5	012970015
T20	100	209	4,5	18.20	5	012970020
T25	100	209	5,0	18.90	5	012970025
T27	115	235	6,0	19.50	5	012970027
T30	115	235	6,0	20.50	5	012970030
T40	130	262	7,0	22.80	2	012970040
T45	130	262	8,0	26.00	2	012970045



1297TX/S12 **CHF 225.00** 1 012970312
T6-T7-T8-T9-T10
T15-T20-T25-T27
T30-T40-T45



Betamax
MAXIMUM PERFORMANCE



1297TX/D6 **CHF 112.00** 1 012970409
T10-T15-T20
T25-T27-T30

1297TX/L

Tournevis à lame longue pour vis Torx®



Ø	L mm	L1 mm	Ø mm	CHF	5	1
T15	210	319	4,0	19.80	2	012970115
T20	210	319	4,5	20.30	2	012970120
T25	210	319	5,0	21.00	2	012970125
T30	210	330	6,0	22.60	2	012970130
T45	210	342	8,0	24.40	2	012970145



Betamax
MAXIMUM PERFORMANCE



1297TX/L-S5 **CHF 108.00** 1 012970325
TX/L15-TX/L20-TX/L25-
TX/L30-TX/L45

1298RTX

Tournevis pour vis Tamper Resistant Torx®



Ø	L mm	L1 mm	Ø mm	CHF	5	1
T9	60	169	4,0	18.20	5	012980009
T10	80	189	4,0	18.60	5	012980010
T15	80	189	4,0	19.80	5	012980015
T20	100	209	4,0	20.00	5	012980020
T25	100	209	4,5	20.30	5	012980025
T27	115	235	5,5	22.00	5	012980027
T30	115	235	6,0	22.80	5	012980030
T40	130	262	7,0	24.40	2	012980040



Betamax
MAXIMUM PERFORMANCE



1298RTX/S8 **CHF 166.00** 1 012980308
T9-T10-T15-T20
T25-T27-T30-T40

1299PZ

Tournevis pour vis Pozidriv®-Supadriv®



UNI/ISO 8764

PZ	L mm	L1 mm	CHF	5	1
0	60	156	12.20	5	012990000
1	80	189	14.30	5	012990003
2	100	220	19.50	5	012990006
3	150	282	28.00	2	012990009
4	200	332	39.50	2	012990012



Betamax
MAXIMUM PERFORMANCE



1299PZ/S6 **CHF 103.50** 1 012990306
1299PZ PZ0-PZ1-PZ2-PZ3
1299NPZ PZ1-PZ2

1299N/PZ

Tournevis à lame courte
pour vis Pozidriv®-Supadriv®



UNI/ISO 8764

PZ	L mm	L1 mm	CHF	5	1
1	30	86	13.90	5	012990021
2	30	86	15.40	5	012990024

Beta
Quality Tools

REPARATION DE VEHICULES

Nos outils de réparation de véhicules qui sont utilisés par les professionnels les plus exigeants, sont développés et fabriqués pour répondre aux normes les plus élevées du monde, et régulièrement testés dans les conditions de fonctionnement les plus difficiles.

Depuis plus de 50 ans, nous travaillons fièrement et en collaboration les plus grands champions des sport mécaniques, nous aidant à améliorer continuellement nos produits et témoignant du niveau de qualité PREMIUM.

Les outils de réparations de véhicules se trouvent dans les sections:

Diagnostics	articles 1438 to 1499 articles 1758VT to 1760TMC
Moteur	articles 955 to 989A articles 1438 to 1499
Vidange	articles 1438 to 1499 articles 1877 to 1885
Système électrique	articles 1438 to 1499
Boosters de démarrage	articles 1498BC/12 to 1498/40A
Transmission	articles 1438 to 1499
Suspension	articles 1549 to 1569CP
Freins	articles 1438 to 1499
Roues	articles 955 to 989A
Carrosserie	articles 1302 to 1369 articles 1763 to 1767A
Autres équipements	articles 1878 to 3067
Levage	articles 3029/2T to 3067/70-13T



1302

Tas à main ronde bombée et panne.



g 770 CHF 122.00 1 013020001

1303

Tas virgule



g 1350 CHF 92.50 1 013030001

1304

Tas semelle



g 875 CHF 116.00 1 013040001

1305

Tas à courbure



g 1190 CHF 73.50 1 013050001

1305Z

Tas à courbure quadrillée



g 1065 CHF 87.50 1 013050002

1306

Tas talon



g 1040 CHF 69.00 1 013060001

1307

Tas américain

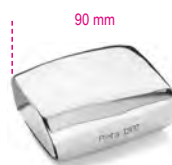

g 1100 CHF 135.50 1 013070001

1308

Tas œuf



g 1100 CHF 126.50 1 013080001

1310

Tas universel



g 1225 CHF 78.00 1 013100001

1312

Tas enclume



g 1220 CHF 167.50 1 013120001

1314
Tas à tête ronde convexe et plate
"diabolo"



g 760 CHF 74.50 1 013140001

1326
Palette simple étroite bombée



g 560 CHF 66.50 1 013260001

1327
Palette simple longue bombée



g 1075 CHF 93.00 1 013270001

1328
Palette simple courte bombée



g 935 CHF 84.50 1 013280001

1329
Palette double à tables larges



g 1800 CHF 257.00 1 013290001

1330
Palette double col de cygne
à tables larges



g 2125 CHF 274.00 1 013300001

1331
Fer à cintrer



g 1100 CHF 152.00 1 013310001

1335BM
Lime à planer,
poignée en matériau thermoplastique



g 500 CHF 44.50 2 013350010

1337/S5
Jeu de 5 spatules de carrossier en acier inox

japonaises
(25-50-75-100-125 mm)



L mm 25-50-75-100-125 CHF 17.10 1 013370015

1338A - 1338B
Monture plate et flexible avec lime fraisée



	mm/1"	L mm	CHF		
1338A	9	360	126.00	2	013380001
1338B	12	360	132.00	2	013380002

1338
Monture sans lime



CHF 68.00 2 013380003

1338R9 - 1338R12
Lime fraisée pour 1338A-B



	mm/1"	CHF		
1338R9	9	57.50	2	013380004
1338R12	12	64.00	2	013380005

1342
Burin plat de carrossier coupe en bout



L mm 235 CHF 39.50 5 013420001

1342PM
Burin plat de carrossier coupe en bout
avec protecteur



L mm 235 L1 mm 118 CHF 56.00 2 013420002

1342PMR
Protecteur pour 1342



CHF 16.40 1 013420003

1343
Burin plat de carrossier coupe latérale



L mm 200 CHF 41.50 5 013430001

1344

Paire de jauges d'épaisseur pour carrossiers à 10 lames avec ventouse de fixation

Indiqués pour :

- positionnement lunettes arrière
- maintien de la position pendant les montages



1344 CHF 47.50 1 013440010

1344A/VW

Outil de démontage de poignée de porte VW



L mm 260 CHF 21.80 1 013440100

1345

Marteau à planer tête ronde bombée et panne coudée, manche en bois



1345 CHF 57.50 2 013450010

1351

Marteau tête plate et panne ronde, manche en bois



1351 CHF 58.00 2 013510010

1353

Marteau tête ronde bombée et panne pointue, manche en bois



1353 CHF 60.00 2 013530010

1357Z/45

Marteau à rétreindre, manche en bois



1357Z/45 CHF 96.00 2 013570045

1359T

Marteau tête ronde plate et panne horizontale, manche en bois



1359 T CHF 57.00 2 013590010

1360G

Marteau en caoutchouc souple sans rebond, pour montage joints et composants délicats



L mm 280 Ø mm 72 CHF 96.50 1 013600000

1360/K6

Marteau en aluminium avec tête ronde plate, embouts en plastique interchangeables et pointeau

- Fourni avec :
- 4 embouts de plastique
 - 1 pointeau réglable en 2 longueurs différentes applicable au marteau



L mm 320 Ø mm 34 CHF 111.00 1 013600006

1360/KP3

Marteau avec tête sphérique et panne pointue avec poinçon, en matière plastique

Le kit comprend :

- 1 marteau de 210 g avec tête Ø 30 mm
- 1 marteau de 290 g avec tête Ø 40 mm
- 1 poinçon de 75 g avec pointe de 5 mm



1360/KP3 CHF 106.50 1 013600503

1361/C12

Jeu d'embouts en Teflon® pour carrosserie



1361/C12 CHF 167.50 1 013610012

≡ 275x160x57 mm

1361/K9

Kit de 8 ventouses de débosselage de carrosserie

Le kit comprend :

- levier à rotule ronde Ø 31 mm longueur 110 cm
- levier avec pointe longueur 62 cm
- levier avec pointe en queue de baleine longueur 112 cm
- levier avec pointe de crochet longueur 27 cm
- levier à tête plate ronde longueur 50 cm
- levier à rotule ronde Ø 19 mm longueur 52 cm
- levier avec tête en queue de baleine longueur 27 cm
- levier avec tête en queue de baleine arrondie longueur 28 cm
- sac en tissu avec poignées

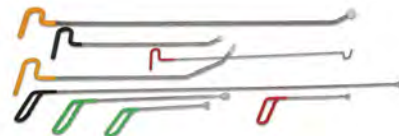

1361/K9 CHF 394.00 1 013610030



1362B

Disque de réflexion flexible pour la détection des bosses

- Surface entièrement revêtue de matériau anti-rayures
- Fourni en étui



	Ø mm	CHF		
1362B	755	101.50	1	013620011

1364SE

Support extensible pour élément de carrosserie

Caractéristiques techniques :

- 4 roues pivotantes dont 2 équipées de frein
- pantographe extensible jusqu'à 1400 mm
- hauteur réglable jusqu'à 1315 mm
- blocage des positions
- surface d'appui revêtue de caoutchouc amovible



	L mm	H mm	P mm	CHF		
215=1400	780=1315	890	522.00	1	013640001	

1364SV

Support de peinture pour carrosserie avec plateau central

Caractéristiques techniques :

- surface d'appui revêtue de polyéthylène
- taille du plateau : 340x845x40 mm
- pliable



	H mm	CHF		
1000	296.00	1	013640002	

1364SCP

Support de peinture ajustable et orientable pour éléments de carrosserie

Particulièrement adapté aux capots, ailes et portières équipé de 4 roues dont 2 pivotantes équipées de frein
Orientable à 180°



	H mm	L mm	P mm	CHF		
1300	1100	680	475.00	1	013640003	

1364SP

Chevalet avec ventouses pour les vitres et les pare-brises automobile

Idéal pour les vitres et les pare-brises automobile équipé de 4 ventouses Ø 95 mm
extension réglable grâce à une chaîne tubulaire revêtue de polyéthylène



	H mm	L mm	CHF		
1250	950	237.00	1	013640004	



1365/K13

Coffret vérin carrossier 10 tonnes sur roulettes pour travaux de redressement de châssis et de carrosserie

Compris dans le kit:

- pompe oléohydraulique 10 tonnes avec tuyau flexible de 1,5 m branchement 1/2"
- piston
- pince écarte pare-chocs capacité 500 kg
- plaque d'appui 150x90 mm
- base en "L" 50x50 mm
- chasse-clous à 4 points
- chasse-clous strié rond Ø 50 mm
- chasse-clous en coin 43 mm
- rallonge 240 mm
- rallonge 450 mm
- rallonge 475 mm
- tête en caoutchouc
- raccord mâle mâle pour montage accessoires



	CHF		
1365/K13	1,028.00	1	013650013

900x420x180 mm

1365P10

Pompe oléohydraulique

Tuyau de 1,5 m, branchement 1/2"



	CHF		
1365P10	458.00	1	013650110

1366A

Kit de débosselage avec jeu de 19 ventouses en plastique

Idéal pour :

- bosselage dû à la grêle
- coups de portière
- petits défauts en général



	CHF		
1366A	115.50	1	013660200

1366B

Marteau coulissant en T pour débosselage sans peinture

Poids du marteau: 500 g



L
mm 440 CHF 64.50 1 013660250

1366KF

Kit de 19 ventouses en plastique pour 1366A



1851VK-12V - 018510072
CHF 42.00 1 013660205

1366/K5

Ventouse de débosselage pneumatique avec masse à inertie de 1,1 kg

Compris dans le kit :

- 1 ventouse Ø 75 mm
- 1 ventouse Ø 100 mm
- 1 ventouse Ø 125 mm
- 1 crochet



CHF 303.00 1 013660010

610x240x90 mm

1366S

Spotter sur chariot pour carrossiers

- Microprocesseur pour la gestion des paramètres de soudage
- Réglage de puissance et durée de soudage
- Champ de réglage 400+2200 Ah
- Sélecteur point unique, pulsé, continu
- Tableau paramètres de soudage
- Indicateur protection thermique
- Pistolet avec coupleur rapide
- Tension 230 V
- 29 kg

CE



CHF 2,095.00 1 013660000

1366S KIT

Kit accessoires pour spotter

- 10 rondelles à œillet
- 10 rondelles à œillet à 90°
- 100 embouts filetés 5x18 mm
- 100 embouts autotaraudeurs 5x18 mm
- 100 embouts autotaraudeurs 5x25 mm
- Crochet pour rondelles Ø 8x16x1,5 mm
- Électrode pour vis M5-M6
- Électrode pour rondelles à œillet



CHF 278.00 1 013660001

250x170x35

1366SL

Levier à tirer pour réparation des tôles

Embout multi-crochets articulé pour utilisation avec fil ondulé



L
mm 700 CHF 243.00 1 013660002

1366ST

Barre de tirage pour réparation tôles

Embout multi-crochets articulé pour utilisation avec fil ondulé



L
mm 850 CHF 771.00 1 013660003

1366S/R1

Mandrin pour rondelles à 3 points



CHF 30.00 1 013660501

1366S/R2

Rondelle à 3 points pour tirage de tôles



CHF 30.00 1 013660502

Les prix indiqués se réfèrent à 20 pièces

1366S/R3

Électrode pour rondelles Ø 8x16x1,5 mm



CHF 36.50 1 013660503

1366S/R4

Crochet pour rondelles Ø 8x16x1,5 mm



CHF 31.50 1 013660504

1366S/R5

Rondelles Ø 8x16x1,5mm



CHF 17.50 1 013660505

Les prix indiqués se réfèrent à 100 pièces

Beta

1366S/R6

Électrode pour vis M5-M6



1366S/R6 CHF 34.50 1 013660506

1366S/R7

100 embouts autotaraudeurs 5x18 mm



1366S/R7 CHF 30.00 1 013660507

1366S/R8

100 embouts autotaraudeurs 5x25 mm



1366S/R8 CHF 41.50 1 013660508

1366S/R9

100 embouts filetés M5 x 18 mm



1366S/R9 CHF 28.00 1 013660509

1366S/R10

10 rondelles à œillet



1366S/R10 CHF 19.40 1 013660510

1366S/R11

Électrode pour rondelles à œillet



1366S/R11 CHF 98.50 1 013660511

1366S/R12

10 rondelles à œillet à 90°



1366S/R12 CHF 38.50 1 013660512

1366S/R13

Électrode au carbone pour revenu tôles



1366S/R13 CHF 70.50 1 013660513

Les prix indiqués se réfèrent à 5 pièces

1366S/R14

Électrode pour soudure par point du fil



1366S/R14 CHF 34.00 1 013660514

1366S/R21

Fils ondulés pour utilisation levier et barre de tirage



1366S/R21 CHF 23.90 1 013660551

Les prix indiqués sont pour 10 pièces

1366S/R22

Support magnétique pour fil ondulé



1366S/R22 CHF 82.50 1 013660552

1366S/R24

Anneau de tirage M4



1366S/R24 CHF 95.50 1 013660554

Les prix indiqués sont pour 5 pièces

1366S/R25

Anneau de tirage M5



1366S/R25 CHF 95.50 1 013660555

Les prix indiqués sont pour 5 pièces

1366S/R26

Anneau de tirage M6



1366S/R26 CHF 95.50 1 013660556

Les prix indiqués sont pour 5 pièces

1367/S4

Jeu d'emporte-pièces pour la pose des capteurs de stationnement

Dimensions : 23 - 24 - 27 - 28

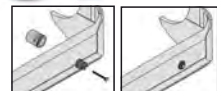

1367/S4 CHF 278.00 1 013670104

1367/K10

Kit d'emporte-pièces pour la pose des capteurs de stationnement

Compris dans le kit :

• mesures : 17 - 18 - 18,2 - 19 - 20 - 22,5 - 24 - 26 - 26,7 - 32 mm



Ø 12 mm

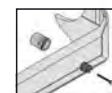

1367/K10 CHF 234.50 1 013670200

190x130x58 mm



1368

Kit de réparation des pièces en plastique

- permet de réparer rapidement les fissures et les ruptures des pièces en plastique

Alimentation: 220+240 V avec prise Schuko
 Longueur câble pistolet thermique: 3,5 m
 Longueur câble alimentation: 1,35 m
 2 réglages de puissance : 35-75 W
 Pistolet thermique avec bouts en cuivre à 2 angles
 d'introduction de l'agrafe: 0°-90°
 Protection input : disjoncteur thermique
 Protection output : fusible 10 A
 Gaine métallique pour ranger le pistolet

CE



1368 CHF 548.00 1 013680001

1368G/K400

Assortiment de 400 agrafes pour 1368



1368G/K400 CHF 93.50 1 013680140

1368G/OD

Agrafes ondulées droites pour 1368



1368G/OD CHF 23.40 1 013680100

Les prix indiqués sont pour 100 pièces

1368G/SD

Agrafes à serpentín droites pour 1368



1368G/SD CHF 23.40 1 013680110

Les prix indiqués sont pour 100 pièces

1368G/CV

Agrafes pour angles convexes pour 1368



1368G/CV CHF 23.40 1 013680120

Les prix indiqués sont pour 100 pièces

1368G/C2U

Agrafes pour angles creux pour 1368



1368G/C2U CHF 23.40 1 013680130

Les prix indiqués sont pour 100 pièces

MANCHES DE MARTEAU

L'Hickory est une essence de bois aux excellentes propriétés qui convient parfaitement aux manches de marteau. Sa structure en fibres longues absorbe les vibrations et le rend extrêmement résistant à la rupture. Dans le cas peu probable où certaines fibres se briseraient, le risque que la tête se détache soudainement est infime.

Les poignées en bois peuvent être remplacées lorsqu'elles sont usées. Le bois étant un matériau naturel, il doit conserver sa propre humidité. Par conséquent, il est déconseillé de stocker le marteau dans un endroit excessivement sec.

Manches en fibre de verre

Les manches fibre de verre sont à la fois durables et robustes ; le risque de casse et de blessures est infime. Ils sont étanches et résistent aux produits chimiques standard.



- Fibre de verre quasi-indestructible

- Manche ergonomique en polypropylène

- Revêtement élastomère antidérapant et confortable

1369/C11

Composition de 11 outils



1369/C11 CHF 1,080.00 1 013690033

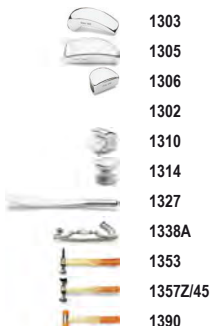

470x340x70 mm - 15,2 kg

1370

Marteau de mécanicien, manche en bois



UNI 7778 DIN 1041

g	A mm	L mm	L1 mm	CHF		
100	15	260	82	15.50	5	013700051
200	19	280	95	17.50	5	013700052
300	23	300	105	20.00	5	013700053
400	25	310	112	22.60	5	013700054
500	27	320	118	24.30	5	013700055
600	30	330	122	28.00	5	013700056
800	33	350	130	31.50	4	013700058
1000	36	360	135	38.00	4	013700060
1500	42	380	145	43.50	2	013700065
2000	47	400	155	51.50	1	013700070



1370/MR...

Manche pour 1370



	CHF			
1370MR 100 1370/100	6.95	4	013700081	
1370MR 200 1370/200	7.75	4	013700082	
1370MR 300 1370/300	8.45	4	013700083	
1370MR 400 1370/400	9.05	4	013700084	
1370MR 500 1370/500	9.90	4	013700085	
1370MR 600 1370/600	10.90	4	013700086	
1370MR 800 1370/800	11.40	4	013700088	
1370MR 1000 1370/1000	12.20	4	013700090	
1370MR 1500 1370/1500	13.80	4	013700095	
1370MR 2000 1370/2000	15.50	4	013700100	

1370T

Marteau de mécanicien, manche en fibre



g	A mm	L mm	L1 mm	CHF		
200	19	280	95	27.00	5	013700620
300	23	300	105	29.50	5	013700630
500	27	320	118	32.00	5	013700650
800	33	350	130	34.00	4	013700680
1000	36	360	135	43.50	4	013700700
1500	42	365	145	51.00	2	013700750

1370F

Marteau de mécanicien tête rivoir, manche en bois



NF E 71.014

A mm	L mm	L1 mm	CHF		
24	260	77	280	27.00	2 013700424
26	260	80	310	28.50	2 013700426
28	280	86	400	30.00	2 013700428
30	280	92	450	31.50	2 013700430
32	300	100	550	33.50	2 013700432
36	300	104	720	43.50	2 013700436
40	330	110	1065	47.50	2 013700440
42	330	116	1080	51.00	2 013700442
50	380	138	1760	53.50	2 013700450
60	380	160	2585	65.50	2 013700460

1370F/MR...

Manche pour 1370F



	CHF		
1370F/MR 24 1370F/24-26	6.80	2	013700474
1370F/MR 28 1370F/28-30	7.45	2	013700478
1370F/MR 32 1370F/32-36	8.60	2	013700482
1370F/MR 40 1370F/40-42	10.80	2	013700490
1370F/MR 50 1370F/50	12.20	2	013700495
1370F/MR 60 1370F/60	14.80	2	013700496

1370FT

Marteau de mécanicien tête rivoir, manche en fibre



A mm	L mm	L1 mm	CHF		
28	280	86	530	44.00	1 013700528
30	280	92	625	46.00	1 013700530
32	300	100	750	47.50	1 013700532
36	300	104	930	57.00	1 013700536
40	330	110	1150	60.00	1 013700540
42	330	116	1250	62.00	1 013700542
50	380	138	2100	69.50	1 013700550
60	380	160	2750	75.00	1 013700560

1374F

Marteau de menuisier tête rivoir, manche en bois



NF E 71.012

A mm	L mm	L1 mm	CHF		
16	250	80	180	21.60	2 013740416
20	270	86	250	24.10	2 013740420
22	290	92	335	24.80	2 013740422
26	290	103	425	28.00	2 013740426
28	310	108	510	29.50	2 013740428
30	310	117	580	31.00	2 013740430

1374F/MR...

Manche pour 1374F



	CHF		
1374F/MR 16 1374F/16	6.35	2	013740456
1374F/MR 20 1374F/20	6.45	2	013740460
1374F/MR 22 1374F/22-26	6.60	2	013740462
1374F/MR 28 1374F/28	7.45	2	013740468
1374F/MR 30 1374F/30	8.00	2	013740470

1375

Marteau de charpentier, manche en bois



g	L1 mm	Ø mm	L mm	CHF		
300	95	25	300	24.80	3	013750000

1375/MR

Manche pour 1375



	CHF		
1375/MR	11.30	2	013750003

1375A

Marteau de charpentier, manche en plastique et fibre de verre



oz	g	L mm	L1 mm	CHF		
16	450	330	130	36.00	3	013750016
20	570	330	130	38.00	3	013750020

1375B

Marteau de charpentier, manche en acier



oz	g	L mm	L1 mm	CHF		
16	450	330	130	33.00	3	013750026
20	570	330	130	33.50	3	013750030

1376X

Marteau de charpentier avec porte-clous aimanté, manche en bois



g	A mm	L1 mm	L mm	CHF		
250	20	125	450	23.70	3	013760125
300	25	130	450	25.00	3	013760130
400	27	132	450	27.50	3	013760140

1376X/MR

manche pour 1376X



1376X/MR	CHF 13.30	2	013760161
----------	-----------	---	-----------

1376XT

Marteau de charpentier avec porte-clous aimanté, manche en plastique



g	A mm	L1 mm	L mm	CHF		
250	20	125	500	28.50	3	013760525
300	25	130	500	30.00	3	013760530
400	27	132	500	32.00	3	013760540

1376XT/MR

Manche pour 1376XT



1376MR/XT	CHF 15.40	2	013760585
-----------	-----------	---	-----------

1377

Marteau américain, manche en bois



HICKORY

g	L mm	L1 mm	CHF		
340	330	95	36.00	2	013770134
450	350	102	38.00	2	013770145
570	350	110	43.50	2	013770157
680	360	116	45.00	2	013770168
900	380	120	47.00	2	013770190

1377/MR...

Manche pour 1377



1377MR 340	CHF 7.90	2	013770234
1377/340			
1377MR 450	9.05	2	013770245
1377/450			
1377MR 570	10.10	2	013770257
1377/570			
1377MR 680	10.20	2	013770268
1377/680			
1377MR 900	12.70	2	013770290
1377/900			

1377T

Marteau américain, manche en fibre



g	L mm	L1 mm	CHF		
340	330	95	33.50	2	013770534
450	350	102	40.50	2	013770545
570	350	110	44.00	2	013770557
680	360	116	47.00	2	013770568
900	380	120	54.00	2	013770590

1378

Marteau américain, manche en bois



HICKORY

g	L mm	L1 mm	Ø mm	CHF		
340	330	100	27	33.00	2	013780134
570	350	115	32	43.50	2	013780157

1378/MR...

Manche pour 1378



1378MR 340	CHF 7.45	2	013780234
1378/340			
1378MR 570	10.40	2	013780257
1378/570			

1379F

Marteau d'électricien tête rivoir, manche en bois



HICKORY

NF E 71.011

A mm	L mm	L1 mm	CHF		
16	250	126	21.50	2	013790416
18	250	135	23.40	2	013790418
20	260	142	24.80	2	013790420

1379F/MR...

Manche pour 1379F



1379F/MR 16	CHF 6.70	2	013790426
1379F/16-18			
1379F/MR 20	7.45	2	013790430
1379F/20			

1380

Massette, manche en bois



HICKORY

UNI 7777 DIN 6475

g	A mm	L mm	L1 mm	CHF		
800	38	260	90	27.50	2	013800208
1000	40	260	95	29.50	2	013800210
1250	43	260	100	31.00	2	013800212
1500	45	280	110	36.00	2	013800215
2000	50	300	120	46.50	2	013800220

1380/MR...

Manche pour 1380



1380MR 800	CHF 8.75	2	013800238
1380/800-1000-1250			
1380MR 1500	9.35	2	013800245
1380/1500			
1380MR 2000	10.70	2	013800250
1380/2000			

1380S

Massette avec collerette de protection, manche en bois



g	A mm	L mm	L1 mm	CHF		
800	36	260	90	30.00	2	013800400
1000	39	260	95	33.50	2	013800405
1250	43	260	100	36.00	2	013800410
1500	45	260	110	40.50	2	013800415

1380S/MR...

Manche pour 1380S



1380S/MR 800	CHF 9.05	2	013800417
1380S/800-1000-1250			
1380S/MR 1500	9.90	2	013800419
1380S/1500			

1380T

Massette,
manche en fibre



g	A mm	L mm	L1 mm	CHF		
800	35	260	85	42.00	2	013800308
1000	40	260	100	42.50	2	013800310
1250	42	260	110	45.00	2	013800312
1500	45	260	120	48.50	2	013800315
2000	49	295	120	59.00	1	013800320

1381

Masse gros effort
avec manche en hickory



g	A mm	L mm	L1 mm	CHF		
3000	55	800	142	112.00	1	013810030
4000	60	900	152	125.00	1	013810040
5000	70	900	162	142.50	1	013810050
8000	80	900	185	246.00	1	013810080

* = Manche en frêne

1381/MR...

Manche pour 1381



	CHF		
1381MR 3-4 1381/3000-4000	56.00	2	013810730
1381MR 5 1381/5000	58.00	2	013810750
1381MR 8 1381/8000	58.00	2	013810780

1381T

Masse gros effort
avec manche en fibre



g	A mm	L mm	L1 mm	CHF		
3000	55	900	142	122.00	1	013810330
4000	60	900	152	134.00	1	013810340
5000	70	900	162	152.50	1	013810350
8000	82	920	180	281.00	1	013810380

1385

Massette en cuivre, manche en bois



g	A mm	L mm	L1 mm	CHF		
400	26	260	75	42.50	2	013850404
600	32	270	80	62.00	2	013850406
800	34	280	90	81.00	2	013850408
1000	37	280	100	101.00	2	013850410
1500	43	280	110	148.00	2	013850415
2000	48	300	120	199.50	1	013850420

1385/MR

Manche pour 1385



	CHF		
1385MR 400 1385 400	12.20	2	013850464
1385MR 600 1385 600	12.50	2	013850466
1385MR 800 1385 800	12.90	2	013850468
1385MR 1000 1385 1000	13.90	2	013850470
1385MR 1500 1385 1500	15.50	1	013850475
1385MR 2000 1385 2000	15.90	1	013850480

1390

Maillet à embouts nylon,
manche en bois



UNI 7784

Ø mm	L mm	L1 mm	CHF		
22	260	70	24.30	5	013900022
28	280	85	30.00	5	013900028
35	310	95	41.00	5	013900035
45	320	107	65.00	4	013900045
60	380	128	110.50	2	013900060

1390/MR...

Manche pour 1390



	CHF		
1390MR 22 1390/22	5.95	2	013900222
1390MR 28 1390/28	6.80	2	013900228
1390MR 35 1390/35	8.15	2	013900235
1390MR 45 1390/45	9.90	2	013900245
1390MR 60 1390/60	12.20	2	013900260

1390R

Embout en nylon pour 1390



Ø mm	CHF		
22	3.85	4	013900122
28	5.90	4	013900128
35	7.90	4	013900135
45	13.30	4	013900145
60	23.10	4	013900160

1390N

Maillet à embouts nylon, manche en bois

Embouts mi-durs : 75 Shore
Résistant à l'huile et à l'usure
Particulièrement adapté pour travailler tôles et métaux



UNI 7784

Ø mm	L mm	L1 mm	CHF		
22	260	70	24.30	3	013900522
28	280	85	30.00	3	013900528
35	310	95	41.00	3	013900535
45	320	107	65.00	2	013900545
60	380	128	110.50	2	013900560

1390NR

Embout en nylon pour 1390N



Ø mm	CHF		
22	3.85	4	013900622
28	5.90	4	013900628
35	7.90	4	013900635
45	13.30	4	013900645
60	23.10	4	013900660

1391

Maillet sans rebond monobloc



Ø mm	L mm	L1 mm	CHF		
35	280	90	37.00	2	013910135
50	320	105	48.50	2	013910150
55	355	110	57.50	2	013910155
65	380	130	78.50	2	013910165

1391A

Maillet de carreleur, entièrement gainée en caoutchouc



g	Ø mm	L mm	L1 mm	CHF		
500	45	290	100	34.50	2	013910205
1000	60	300	120	46.50	2	013910210

1392

Maillet sans rebond à poignée surmoulée grand confort, manche en acier



Ø mm	L mm	L1 mm	CHF		
30	300	105	62.50	2	013920030
35	305	115	67.00	2	013920035
40	310	125	77.50	2	013920040
50	325	135	91.00	2	013920050
60	385	155	140.50	2	013920060

1392R

Embout en nylon pour 1392



Ø mm	CHF		
30	8.45	4	013920230
35	12.30	4	013920235
40	18.70	4	013920240
50	24.90	4	013920250
60	37.00	4	013920260

1393

Massette avec tête en caoutchouc dur



Ø mm	L mm	L1 mm	CHF		
50	315	90	16.50	3	013930050
60	340	110	18.70	3	013930060
70	370	130	22.50	2	013930070

REPARATION DE VEHICULES

Nos outils de réparation de véhicules qui sont utilisés par les professionnels les plus exigeants, sont développés et fabriqués pour répondre aux normes les plus élevées du monde, et régulièrement testés dans les conditions de fonctionnement les plus difficiles.

Depuis plus de 50 ans, nous travaillons fièrement et en collaboration les plus grands champions des sport mécaniques, nous aidant à améliorer continuellement nos produits et témoignant du niveau de qualité PREMIUM.

Les outils de réparations de véhicules se trouvent dans les sections:

Diagnostique	articles 1438 to 1499 articles 1758VT to 1760TMC
Moteur	articles 955 to 989A articles 1438 to 1499
Vidange	articles 1438 to 1499 articles 1877 to 1885
Système électrique	articles 1438 to 1499
Boosters de démarrage	articles 1498BC/12 to 1498/40A
Transmission	articles 1438 to 1499
Suspension	articles 1549 to 1569CP
Freins	articles 1438 to 1499
Roues	articles 955 to 989A
Carrosserie	articles 1302 to 1369 articles 1763 to 1767A
Autres équipements	articles 1878 to 3067
Levage	articles 3029/2T to 3067/70-13T



1410/M

Crochet pour traction des ressorts



Ø mm	CHF		
3,5	23.70	2	014100051

1428

Extracteur d'écrous endommagés avec carrés 3/8" et 1/2"



Ø mm	□	L mm	Ø mm	CHF		
8	3/8	36	17	23.70	2	014280008
10	3/8	36	17	23.70	2	014280010
11	3/8	36	17	23.70	2	014280011
12	3/8	36	19	23.70	2	014280012
13	3/8	36	19	23.70	2	014280013
14	3/8	36	19	23.70	2	014280014
15	1/2	38	21	25.00	2	014280015
16	1/2	38	21	25.00	2	014280016
17	1/2	38	21	25.00	2	014280017
18	1/2	38	26	25.00	2	014280018
19	1/2	38	26	25.00	2	014280019
20	1/2	38	26	28.00	2	014280020
21	1/2	38	26	28.00	2	014280021
22	1/2	38	26	30.00	2	014280022
24	1/2	38	26	30.00	2	014280024
27	1/2	38	26	31.50	2	014280027

1428L

Douille extractrice d'écrous endommagés, série longue, avec carrés 3/8" et 1/2"



Ø mm	CHF		
17	60.00	1	014280217
19	62.00	1	014280219
21	66.50	1	014280221



CHF		
188.50	1	014280303



CHF		
288.00	1	014280111
159.50	1	014280115

1429

Extracteur de vis et goujons cassés avec carrés 3/8" et 1/2"



mm	□	L mm	CHF		
2	3/8	60	15.60	3	014290002
3	3/8	60	15.60	3	014290003
4	3/8	60	15.60	3	014290004
5	3/8	60	16.50	2	014290005
6	3/8	60	16.50	2	014290006
8	1/2	70	18.00	2	014290008
10	1/2	70	18.40	2	014290010



1429/SB7	CHF		
2-3-4-5-6-8-10 mm	130.00	1	014290107

1430/...

Extracteur de goujons cassés en acier allié

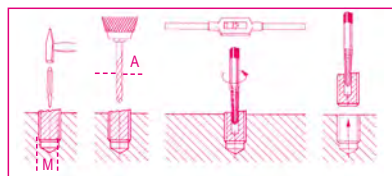

	M	A mm	CHF		
1430/1	3÷6	2,5	4.40	10	014300006
1430/2	6÷8	3,0	4.90	10	014300008
1430/3	8÷11	4,5	5.90	10	014300011
1430/4	11÷14	6,0	7.75	10	014300014
1430/5	14÷18	8,0	8.75	10	014300018
1430/6	18÷24	11,0	17.10	5	014300024
1430/7	24÷33	14,0	25.50	5	014300033
1430/8	33÷50	21,0	33.00	5	014300050



	CHF		
1430/S5	33.00	1	014300105
1430/1-1430/2-1430/3			
1430/4-1430/5			
1430/S6	47.00	1	014300106
1430/1-1430/2-1430/3			
1430/4-1430/5-1430/6			
1430/S8	105.50	1	014300108
1430/1-1430/2-1430/3			
1430/4-1430/5-1430/6			
1430/7-1430/8			

1431/...

Extracteur de vis et goujons cassés

Pour enlever les vis et les goujons sans possibilité de prise insertion à percussion

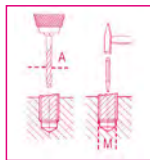

	M	A	L	□	CHF		
	mm	mm	mm	mm			
1431/3	3÷6	2,5	59	5	7.90	10	014310051
1431/5	6÷8	5,0	68	5	7.90	10	014310052
1431/6	8÷11	6,0	72	6	9.35	10	014310053
1431/8	11÷14	8,0	77	8	10.20	10	014310054
1431/9	14÷18	9,0	82	9	10.90	10	014310055

1431/C5

Extracteurs coniques pour vis et goujons brisés

Insertion à percussion

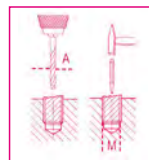

	M	A	CHF		
	mm	mm			
1431/C5	6÷18	3÷9	46.50	1	014310005

1433

Extracteur à rouleaux pour goujons

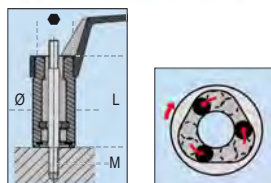

M	∅	L	□	CHF		
mm	mm	mm	mm			
5	21	60	19 3/8	17.50	2	014330005
6	24	60	21 1/2	17.50	2	014330006
7	24	60	21 1/2	17.50	2	014330007
8	24	60	21 1/2	17.50	2	014330008
9	28	70	21 1/2	20.70	2	014330009
10	28	70	21 1/2	20.70	2	014330010
10,5	28	70	21 1/2	20.70	2	014330021
11	28	70	21 1/2	20.70	2	014330011
12	28	70	21 1/2	20.70	2	014330012
14	36	72	24 -	33.00	2	014330014
16	36	72	24 -	33.00	2	014330016

1433/C11

Extracteur à rouleaux pour goujons avec carré femelle 1/2"



1433/C11	CHF		
M5 - M6 - M7 - M8 - M9 - M10 - M10,5 - M11 - M12 - M14 - M16	339.00	1	014330311
340x135x56 mm - 3,0 kg			

1435

Extracteur de goujons à molette



∅ mm	CHF		
4÷20	127.00	1	014350001

1435R

Molette pour 1435



1435R	CHF		
	39.50	1	014350010

1435/1

Extracteur de goujons à molette

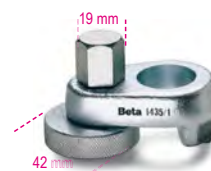

∅ mm	CHF		
19÷26	157.50	1	014350002

1435/1R

Molette pour 1435/1

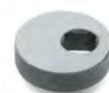

1435/1R	CHF		
	41.00	1	014350011

1437/C12

Composition de 12 outils pour enlever les airbags



1437/C12 CHF 126.50 1 014370001
260x160x55 mm - 1,0 kg

1438

Centre universel d'embrayage avec 3 cônes extensibles



1438 CHF 68.00 1 014380001

1438R

Embouts pour 1438



∅ mm	CHF	1	014380101
14÷18	4.65	5	014380101
18÷21	4.65	5	014380102
22÷25	4.65	5	014380103

1438DCT

Outil pour démontage, montage embrayage vitesses DCT à 6 rapports
Utilisable sur Volvo, Ford, Chrysler, Dodge

38"



1438DCT CHF 196.00 1 014380300

1438EVO

Kit universel pour le centrage des embrayages

Composants entièrement en métal



1438EVO CHF 304.00 1 014380011
290x200x60 mm - 2 kg

1438DSG

Levier pour blocage/débloqué des boîtes de vitesses DSG à double embrayage du groupe VAG



1438DSG CHF 41.50 1 014380200

1438K/DSG-2

Kit d'outils pour l'alignement des embrayages DSG, 6 et 7 vitesses à partir de 2003

Pour utilisation avec DSG 6 rapports et transmission manuelle, DSG à 7 rapports (séries 1 et 2) et S-tronic.



1438K/DSG-2 CHF 766.00 1 014380260
350x370x117 mm - 10 kg

1438K/PWR

Kit d'outils de dépose / d'installation pour transmission sèche à double embrayage Ford et Volvo



1438K/PWR CHF 525.00 1 014380270
440x400x85 mm - 10 kg

1438DCT/S

Kit d'outils pour aligner les doubles embrayages à secs Ford

pour l'alignement de l'embrayage après l'exécution des travaux comme le remplacement du joint d'huile d'embrayage



1438DCT/S CHF 398.00 1 014380305
440x400x85 mm - 8 kg

1439/K7

Coffret tournevis long à renvoi d'angle 90° avec lames



Composition coffret:
- Tournevis à renvoi d'angle
- 1 embout pour vis à fente
- 1 douille porte-embouts
- 1 embout pour lames spéciales
- 7 lames spéciales

1439K7 CHF 253.00 1 014390101
500x120x60 mm - 825 g

1440/...

Collier à segments



	Ø mm	L mm	CHF		
1440/0	40÷75	50	38.00	1	014400000
1440/1	57÷125	80	49.50	1	014400010
1440/1A	57÷125	100	56.50	1	014400011
1440/2	90÷175	80	60.00	1	014400020
1440/2A	90÷175	100	62.50	1	014400021
1440/3	90÷175	165	91.50	1	014400030

1445/1 - 1445/2

Pince à segments



	Ø mm	CHF		
1445/1	50÷100	52.00	1	014450001
1445/2	90÷150	66.50	1	014450002

1452K

Lève-soupapes avec trois brides

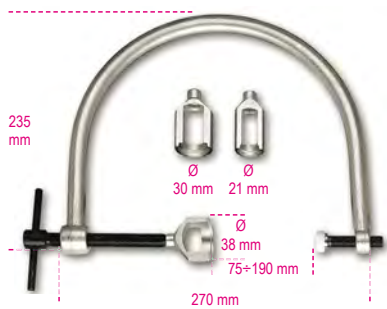

	CHF		
1452K	197.00	1	014520100

1452PN/K

Démonte soupapes pneumatique

Pression de poussée 1400 N



Ø mm	L mm	L1 mm	CHF		
16-19-23	230	185	420.00	1	014520110
25-30-42					

1454P

Grattoir pour enlever les résidus de mastic et d'emballage

Particulièrement recommandé pour le nettoyage des têtes et surfaces planes à coupler



L mm	L1 mm	Ø mm	CHF		
210	32	3,3	55.00	1	014540010

1455SVP

Rodoir de soupapes pneumatique

• Pression d'alimentation: 6 bars



	CHF		
1455SVP	480.00	1	014550001

1455SVP/R...

Ventouses en caoutchouc pour 1455SVP



	CHF		
1455SVP/R1	8.60	5	014550501
1455SVP/R2	8.60	5	014550502
1455SVP/R3	8.60	5	014550503

1457/B4

Jeu d'outils pour le déblocage des connecteurs Rilsan

Mesures comprises :

- 6x8
- 10x12
- 15x16
- 18x1/2



	CHF		
1457/B4	64.50	1	014570024

1458

Pince à joncs extérieurs



DIN 5417	CHF		
200 mm	94.00	2	014580001

1460F

Pince pour joints d'étanchéité de soupapes



	CHF		
1460F	80.50	1	014600010

1461/C5G

Outils pour le calage des moteurs Fiat/Alfa/Lancia/Opel/Suzuki/Ford diesel

Moteurs: 1.3 Multijet



	CHF		
1461/C5G	391.00	1	014610053

1461/C6B

Outils pour le calage des moteurs Peugeot/Citroën essence

Moteurs: 1.0-1.1-1.4-1.6-1.6 16v-1.6Gti-1.6 18V-1.8-1.8 16v-1.9-2.0-2.0 16v-2.0T-2.0 Hpi-2.2 16v



	CHF		
1461/C6B	588.00	1	014610063

1461/C6G

Outils pour le calage des moteurs
Peugeot/Citroën diesel

Moteurs: 1.4-1.6-2.0D, 1.4-1.6TDCI, 1.4-1.6-2.0-2.2Hdi,
1.5-1.9-2.5D



1461/C6G CHF 776.00 1 014610064
385x290x100 mm 3,8 kg

1461/C7B

Outils pour le calage des moteurs
Renault/Nissan essence

Moteurs: 1.4-1.6-1.8-2.0 16V



1461/C7B CHF 445.00 1 014610072
280x245x75 mm 3,2 kg

1461/C8B

Outils pour le calage des moteurs Ford
essence

Moteurs: 1.25-1.4-1.6-1.6 SCTi-1.6 Ti-VCT-1.6 16V



1461/C8B CHF 309.00 1 014610083
240x210x50 mm 1,8 kg

1461/C9B

Outils pour le calage des moteurs Opel
essence

Moteurs: 1.0 12V, 1.0-1.2-1.4 16V



1461/C9B CHF 246.00 1 014610092
335x145x60 mm 2 kg

1461/C11A

Outils pour le calage des
moteurs Renault

Moteurs: 2.0 dCi



1461/C11A CHF 261.00 1 014610111
420x280x60 mm - 1,2 kg

1461/C12A

Outils pour le calage des
moteurs Fiat

Moteurs: 1.9-2.2 JTS e 1,9 JTD Euro 4



1461/C12A CHF 465.00 1 014610123
280x245x75 mm - 1,8 kg

1461/C13B

Outils pour le calage des moteurs Fiat 1.4
Multiair



1461/C13B CHF 321.00 1 014610134
240x210x50 mm 2,8 kg

1461/C18B

Outils pour le calage des moteurs
Volkswagen/Audi/Seat et Skoda essence

Moteurs: 1.6-1.8-1.8T, 1.4-1.6-1.8-2.0 16V,
1.4-1.6-2.0 FSI



1461/C18B CHF 610.00 1 014610182
310x290x120 mm 2,5 kg

1461/C20G

Outils pour le calage des moteurs
Fiat Iveco/Peugeot/Citroën/Ford diesel

Moteurs: 2.2-2.3-3.0 Multijet



1461/C20G CHF 1,061.00 1 014610221
385x290x100 mm 5,5 kg

1461/C21G

Outils pour le calage des moteurs Renault diesel

Moteurs : 1.6 dCi



1461/C21G CHF 598.00 1 014610222

310x290x120 mm 3 kg

1461/C23B

Outils pour le calage des moteurs Opel essence

Moteurs : 1.0 - 1.2 - 1.4 ecoflex



1461/C23B CHF 763.00 1 014610224

280x245x75 mm 2,5 kg

1461/C24B

Outils pour le calage des moteurs Mini-Peugeot/Citroën essence

Moteurs : 1.4 - 1.6 (N12-N14)



1461/C24B CHF 889.00 1 014610225

280x245x75 mm 2,8 kg

1461/C25G

Outils pour le calage des moteurs Mini diesel

Moteurs : 1.6 diesel (W16D)



1461/C25G CHF 198.50 1 014610226

270x120x45 mm 1 kg

1461/C27G

Outils pour le calage des moteurs Bmw diesel

Moteurs : 1.6-2.0D (N47-N47S)



1461/C27G CHF 357.00 1 014610228

280x245x75 mm 2 kg

1461/C28B

Outils pour le calage des moteurs Volkswagen, Seat, Skoda essence

moteurs : 1.0 - 1.0 Bluemotion Tech
1.0 Ecofuel/Ecomotive - 1.0 Green Tech



1461/C28B CHF 636.00 1 014610229

280x245x75 mm 1,7 kg

 **Beta**
Quality Tools

1461/C29B

Outils pour le calage des moteurs Ford essence moteurs : 1.0 EcoBoost



1461/C29B CHF 914.00 1 014610209

280x245x75 mm 2,6 kg

1461/C30G

Outils pour le calage des moteurs Volkswagen/Audi/Seat et Skoda diesel

moteurs : 1.6-2.0 CR TDI
pour moteurs à partir de 2012



1461/C30G CHF 827.00 1 014610231

280x245x75 mm 2 kg

1461/C32G

Outils pour le calage des moteurs Opel diesel

Moteurs : 1.6 CDTi (B16)



1461/C32G CHF 407.00 1 014610233

270x230x80 mm 1,3 kg

 **Beta**
Quality Tools

1461/C33B

Outils pour le calage des moteurs Opel essence

Moteurs : 1.0 - 1.0 Turbo SIDI Ecoflex



1461/C33B CHF 132.50 1 014610234

1462CF/C6

Jeu de 6 clés polygonales ouvertes pour raccords d'injecteurs

Dimensions: 12-14-16-17-18-19 mm

12"



1462CF/C6 CHF 125.00 1 014620006

260x145x60 mm - 1,2 kg

1462CF

Clé polygonale ouverte pour raccords d'injecteurs

12"



mm	CHF		
12	20.00	1	014620012
14	20.20	1	014620014
16	20.60	1	014620016
17	21.00	1	014620017
19	22.10	1	014620019
18	21.50	1	014620018

1462CF-SN/C6

Jeu de 6 clés 6-pans articulées ouvertes pour raccords d'injecteurs

Mesures : 12-14-16-17-18-19

38"



1462CF-SN/C6 CHF 181.50 1 014620026

275x182x64 mm

1462CF-SN

clés hexagonales articulées à une extrémité pour connecteurs d'injecteur de carburant

38"



mm	CHF		
12	31.50	1	014620032
14	32.00	1	014620034
16	34.00	1	014620036
17	34.50	1	014620037
18	35.50	1	014620038
19	37.00	1	014620039

1462/KD

Composition d'outils pur l'extraction des injecteurs Denso incluant l'extracteur à inertie



1462/KD CHF 1,089.00 1 014620060

335x210x80 mm - 4,8 kg

1462/KI

Composition d'outils pour extraction injecteurs Diesel Common Rail

Permet d'enlever les injecteurs DELPHI-BOSCH-SIEMENS-DENSO



1462/KI CHF 3,250.00 1 014620235

530x470x140 mm - 2,0 kg

1462/KMRC

Composition d'outils pour l'extraction des injecteurs sur moteurs Mercedes 2.1L, 2.2L, 3.0 V6 et Chrysler

Pour injecteurs Bosch (2.1 et 2.2L) et Delphi (3.0) Permet l'extraction des injecteurs sans enlever le moteur.

Particulièrement indiquée pour les modèles : Mercedes Vito, Vario, CLK, Sprinter, Viano, Classe M, GL, C, GLK, E, CLS, S, R, G Chrysler 300 C



1462/KMRC CHF 923.00 1 014620070

310x300x118 mm - 3,5 kg

1462/KU

Composition universelle d'outils pour l'extraction des injecteurs Diesel Common Rail Incluant pince et extracteur à inertie



1462/KU CHF 971.00 1 014620100

390x290x100 mm - 4,5 kg

1462/MB

Kit de face de marteau pour retirer les injecteurs

Contenu du kit :

- 1 face de marteau de 4 kg avec tige de 400 mm
- 1 adaptateur articulé, mâle M10x1.5, femelle M22x1.5 mm
- 1 adaptateur, mâle M22x1.5, femelle M13x1.4 mm
- 1 adaptateur, mâle M14x1.5, femelle M27x1 mm
- 1 adaptateur, mâle M14x1.5, mâle M25x1 mm
- 1 adaptateur, mâle M14x1.5, mâle M27x1 mm
- 1 adaptateur, mâle M14x1.5, femelle M14x1.5 mm
- 1 adaptateur, mâle M14x1.5, mâle M20x1 mm
- 1 adaptateur, mâle M14x1.5, mâle M17x1 mm



1462/MB CHF 391.00 1 014620110

500x250x80 mm - 7,2 kg

Beta

1462AD/BSC

Adaptateur pour l'extraction des injecteurs
Bosch Common Rail

À utiliser avec les articles Beta 960KI et Beta 1462/KU



1462AD/BSC CHF 281.00 1 014620435

1462AD/SMN

Kit d'adaptateurs pour l'extraction des injecteurs

Siemens et Denso

À utiliser avec l'article Beta 960KI/1462KI



1462AD/SMN CHF 422.00 1 014620436

1462/EI

Outil universel à vibrations pour extraction des injecteurs

- Favorise l'extraction d'injecteurs fortement grippés de leur logement, sans abîmer la tête et en évitant d'éventuelles ruptures.
- Utilisable avec tous kits d'extraction d'injecteurs avec ou sans extracteur à inertie
- L'outil agit directement avec ses vibrations et percussions sur le tirant d'extraction qui est accouplé avec l'injecteur
- Au moyen de la vanne de réglage, il est possible d'adapter l'intensité de la vibration en fonction du type d'intervention à effectuer.

CE



1462/EI CHF 859.00 1 014620240

1462PIM

Paire de plaques pour la maintenance des injecteurs

Pour le blocage en étiau

Sections :

Ø 11-12-13-14-16-19-20 mm



1462PIM CHF 135.50 1 014620502

1463/KIT

Kit outillage pour blocage des poulies de distribution



1463/KIT CHF 525.00 1 014630001

280x140x75 mm - 1,2 kg

1464T

Testeur de pression digital

CARACTÉRISTIQUES

- Écran tactile de 5"
- Batterie au lithium polymère rechargeable
- Capteur de 80 bars (basses pressions) et câble USB



CE

Avec kit 960AD/TP2, il permet de vérifier :

- compression moteurs essence et diesel
- pression huile moteur
- basse pression common rail
- pression injection essence

Avec kit 1464AP, il permet de vérifier :

- pression réelle circuit common rail
- pression pompe haute pression

1464T CHF 1,142.00 1 014640050

1464T/SP80

Capteur de pression de 80 bars pour 1464T et 960TP



1464T/SP80 CHF 392.00 1 014640053

960AD/TP2

Jeu d'adaptateurs pour 1464T, en coffret plastique



960AD/TP2 CHF 677.00 1 009600510

430x310x50 mm - 3,2 kg

1464CBD

Jeu complet d'adaptateurs pour le contrôle de la compression dans les moteurs essence et Diesel

avec 1464T

Permet de se connecter au moteur pour le contrôle de la compression essence et Diesel au moyen de l'instrument 1464T.

Comprend :

- 8 fausses bougies avec vanne de non-retour
- 44 fausses petites bougies avec vanne de non-retour
- 1 faux injecteur réglable universel pour voitures, camions, moteurs marins et machines agricoles
- 1 adaptateur à 90°, soupape de sécurité et tuyau de branchement
- espace pour loger l'instrument 1464T à l'intérieur du coffret



1464CBD CHF 932.00 1 014640300

510x410x140 mm - 5,5 kg

1464IC

Kit complet de faux injecteurs et de fausses bougies, pour 1464T

Permet de se brancher au moteur pour le contrôle de la compression des moteurs diesel avec le testeur numérique 1464T

Comprend :

- 22 fausses bougies
- 5 faux injecteurs
- 1 kit faux injecteur universel pour voitures, camions, bateaux et machines agricoles



1464IC CHF 766.00 1 014640350

559x312x50 mm - 4,5 kg

1464IC/RK

Kit faux injecteur universel pour voitures, camions, bateaux et machines agricoles

Fourni avec art. 1464IC



1464IC/RK CHF 247.50 1 014640377

200x110x30 mm - 885 g

1464AP

Kit pour le contrôle du système haute pression des moteurs diesel common rail, avec 1464T

Éléments fournis :

- jeu de tuyaux haute pression
- raccords de branchement
- capteur de 2.000 bars



1464AP CHF 1,032.00 1 014640450

430x310x50 mm - 1,8 kg

1464APT

Tuyau haute pression pour 1464AP et 960TAP



1464AP T12X12 CHF 80.50 1 014640453
1464AP T12X14 CHF 80.50 1 014640454
1464AP T14X12-M1,0 CHF 80.50 1 014640455

1464AP T16X12



1464AP T16X12 CHF 95.50 1 014640456

1464FG

Jeu de faux régulateurs pour le contrôle du système Diesel common rail (à utiliser avec les articles 1464T-1464AP)

Utilisé avec le testeur et les adaptateurs dédiés, permet de comprendre si le problème se situe au niveau de la pompe haute pression ou du régulateur en cas d'absence de pression dans le circuit de haute pression dans les moteurs Diesel common rail. Indiqué pour les régulateurs de pression Bosch, Delphi, Denso et Siemens



1464FG CHF 398.00 1 014640470

350x250x80 mm - 1,8 kg

1464FG/CP4

Faux régulateur pour pompe Bosch CP4 non inclus dans 1464FG



1464FG/CP4 CHF 58.00 1 014640475

1464APB

Kit de contrôle du système essence haute pression des moteurs FSI, à utiliser avec 1464T

Comprend un capteur de 200 bars et raccords de branchement



1464APB CHF 507.00 1 014640500

240x210x50 mm - 0,5 kg

1464PB

Jeu de 9 connecteurs pour le contrôle de la basse pression carburant (à utiliser avec 1464T)

A travers les connexions rapides reliées au testeur 1464T effectue rapidement le contrôle de la basse pression carburant pour moteurs Diesel et essence



1464PB CHF 706.00 1 014640700

530x440x120 mm - 3,8 kg

1464ADB

Kit pour le contrôle de la pression du système AdBlue® pour 1464T

Fourni avec adaptateurs à utiliser avec le capteur standard de 80 bar présent dans le 1464T



1464ADB CHF 117.00 1 014640620

240x210x50 mm - 0,5 kg

1464FAP

Kit pour le contrôle de la pression du filtre à particules DPF pour 1464T

Fourni avec :

- capteur de 500 mbar
- adaptateur de 8 mm avec attache rapide et raccord en T
- câble RJ45 de 3 mètres



DONNÉES TECHNIQUES
test de pression : 0+500 mbar
résolution : 1 mbar

1464FAP CHF 252.00 1 014640610

240x210x50 mm - 0,5 kg

1464PT

Kit pour le contrôle de la pression du turbo à utiliser avec 1464T

Comprend capteur et câble de branchement



1464PT CHF 222.00 1 014640550
240x210x50 mm - 380 g

1464TDI

Kit pour le contrôle de la pression de la pompe à injection des moteurs TDI à utiliser avec 1464T

Comprend raccord de branchement



1464TDI CHF 158.50 1 014640600
240x210x50 mm - 400 g

1464VD

Kit pour contrôle dépression/vide pour 1464T

Permet de mesurer et mémoriser la valeur maximum de la dépression

Fourni avec :

- capteur de 800 mbar
- adaptateurs de 6 et 8 mm
- câble RJ45 de 3 mètres

DONNÉES TECHNIQUES

Test de vide : 0÷800 mbar

Résolution : 1 mbar

Mémorisation de la valeur maximale



1464VD CHF 252.00 1 014640570
240x210x50 mm

1464PF

Kit pour le contrôle de la pression dans le système de freinage à utiliser avec 1464T

Comprend adaptateurs et raccords



1464PF CHF 909.00 1 014640650
400x280x60 mm - 3 kg

1465

Outil de contrôle de l'efficacité moteur

Permet de vérifier en quelques secondes la compression des moteurs endothermiques sans devoir se connecter au moteur en prélevant l'alimentation de la batterie du véhicule, au moyen d'un logiciel dédié



1ère phase : calcul tours/moteur
2ème phase : analyse situation tension batterie à chaque tour
3ème phase : affichage puissance électrique absorbée et compression correspondante calculée au moyen de l'action du démarreur pour chaque piston
4ème phase : contrôle état de chargement et efficacité de la batterie

DONNÉES TECHNIQUES
Tension de fonctionnement : 12V DC (batterie véhicule)
Dimensions : 140x75x30 mm
Longueur câble pinces : 1300 mm

1465 CHF 1,525.00 1 014650010

1466/C5

Jeu de 5 clés pour la purge des freins

Le jeu comprend :

- 5 clés de dimensions 7-8-9-10-11 mm
- 1 tuyau de purge avec clapet anti-retour



1466/C5 CHF 167.50 1 014660100
260x170x50 mm - 600 g

1466L 11

Clé 11 mm pour purge freins, version longue



1466L 11 CHF 41.50 1 014660211
11 mm L 60 mm

1466TLF

Bidon pour la collecte d'huile de freins capacité 1,5 litres

Attache rapide pour tuyau de purge Ø 5,5 mm



1466TLF CHF 60.00 1 014660201

1467

Purgeur de freins pneumatique par dépression



Pression min. 5 bar, max. 11,5 bar

1467 CHF 446.00 1 014670001
1,5

1467/RK1

Kit tuyau pour 1467



1467/RK1	CHF 33.50	1	014670501
----------	--------------	---	-----------

1467/RK2

Flacon de remplissage pour 1467



1467/RK2	CHF 128.50	1	014670502
----------	---------------	---	-----------

1467LF/2

purgeur de freins électronique

Avec "pulsation"



- Arrêt automatique lorsque le bidon est vide, ce qui évite l'introduction d'air
 - Volume maximum bidon : 20 l
 - Pression de service : 0,4÷3,5 bars
 - Alimentation : 230V
- Équipement fourni :
- Bidon de collecte de l'huile des freins
 - 1 bouchon E20 standard

1467LF/2	CHF 2,325.00	1	014670099
----------	-----------------	---	-----------

1467LF/RC

Bidon de collecte avec tuyau pour 1467LF



1467LF RC	CHF 141.50	1	014670125
-----------	---------------	---	-----------

1467TU

Bouchon pour cuves
liquide freins

- Adaptable sur 90 % des cuves du parc
- Utilisable avec article Beta 1467LF



1467TU	CHF 87.50	1	014670090
--------	--------------	---	-----------

1467T/C6

Jeu de 6 bouchons d'adaptation pour réservoirs de liquide de frein, à utiliser avec les articles BETA 1467LF et 1467LF / 2

Contenu du set:

- 1 bouchon pour les véhicules Toyota
- 1 bouchon pour les véhicules Ford, Hyundai, Mazda, Mitsubishi, Nissan, Subaru
- 1 bouchon pour les véhicules Honda
- 1 bouchon pour les véhicules Mazda et Suzuki
- 1 bouchon pour les véhicules Nissan
- 1 bouchon adaptateur de purge des freins pour véhicules européens



1467T/C6	CHF 355.00	1	014670080
----------	---------------	---	-----------

350x240x85 mm - 1,8 kg

1468N

Levier de compression des poussoirs de soupapes

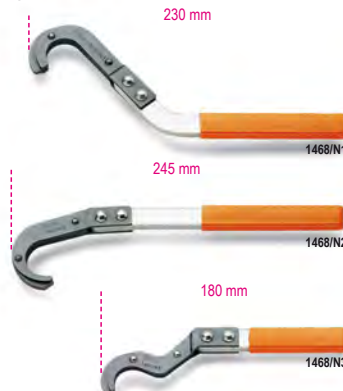

1468N/1	CHF 32.00	1	014680011
1468N/2	33.00	1	014680012
1468N/3	33.50	1	014680013

1470

Pince pour garniture de frein



L mm	CHF	1	014700001
210	52.00	1	014700002
330	66.50	1	014700010
540	199.50	1	014700010

1470FT

Pince pour garniture de frein à tambour

Becs inclinés à 40°

Accessibilité dans les endroits difficiles

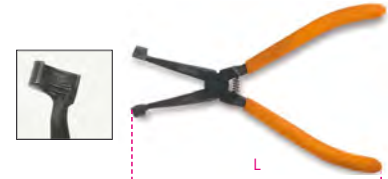

L mm	CHF	1	014700000
184	55.00	1	014700000

1470PF

Outil pour le remplacement des cylindres dans les freins à tambour

Les mâchoires restent ouvertes et le cylindre est facilement remplacé.

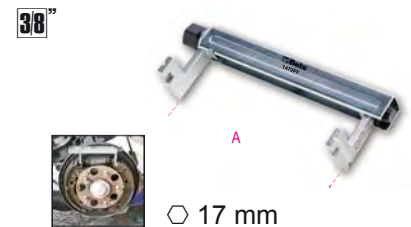

A mm	CHF	1	014700200
25÷140	100.50	1	014700200

1471

Pince pour garniture de frein



L mm	CHF	1	014710001
330	101.50	1	014710001

1471A

Pince pour frein à main



A max mm	B mm	CHF	2	014710010
45	5	123.50	2	014710010

1471GF

Paire de crochets modelables pour le soutien de la pince frein



1471GF	Max kg 5	CHF 18.70	1	014710310
--------	-------------	--------------	---	-----------

1471M/C22

Outil pneumatique pour positionner les pistons des freins à disque, avec tourne à gauche et tourne à droite et accessoires



1471M/C22	CHF 398.00	1	014710101
350x310x85 mm - 3,5 kg			

1471M/50

Coffret repousse-pistons pneumatique pour positionner les pistons de freins à disque, avec tourne à droite et tourne à gauche et accessoires

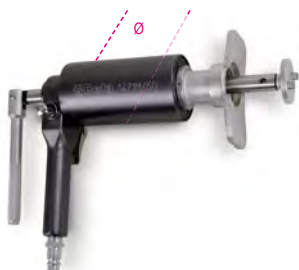

Ø 50	Kg 150	Bar 5÷8	CHF 219.50	1	014710069
---------	-----------	------------	---------------	---	-----------

1471M/P

Adaptateur pour plaquettes usées et étriers TRW-Mégane



1471M/P	CHF 34.00	1	014710080
---------	--------------	---	-----------

1471M/W50

Adaptateur pour frein de stationnement VW Passat ≥ 2005

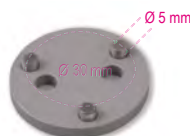

1471M/W50	CHF 12.00	1	014710079
-----------	--------------	---	-----------

1471PN/B1

Adaptateur pour frein de stationnement Ford



1471PN/B1	CHF 12.00	1	014710081
-----------	--------------	---	-----------

1471PN/B2

Adaptateur pour frein de stationnement Daily



1471PN/B2	CHF 16.60	1	014710082
-----------	--------------	---	-----------

1471PN/B3

Adaptateur pour frein de stationnement BMW



1471PN/B3	CHF 12.00	1	014710083
-----------	--------------	---	-----------

1471PN/B4

Adaptateur pour frein de stationnement BMW



1471PN/B4	CHF 12.00	1	014710084
-----------	--------------	---	-----------

1471PN/B5

Adaptateur pour frein de stationnement Mini/BMW



1471PN/B5	CHF 10.40	1	014710085
-----------	--------------	---	-----------

1471CF

Douilles 5 pans pour écrous étriers de frein



mm	CHF	1	014710314
14	23.40		
19	23.40		014710319

1471CM

Douille mâle 5 pans pour vis étriers de frein



mm	CHF	1	014710360
10	23.40		

1471CM/E11

Douille mâle 6 pans 11 mm pour vis des étriers de frein Mercedes ML (Série 166)



mm	Ø	L	L1	CHF	1	014710361
11	24	75	15,5	24.80		

1471PT/C5

Kit douilles à chocs pour écrous d'étriers de frein

Pour les voitures du groupe Volkswagen, Audi et Porsche
• 3 douilles à 10 dents : 11,5 mm - 15 mm - 20 mm
• 2 douille à 7 dents : Ø 14 mm - 22 mm



1471PT/C5	CHF 95.50	1	014710367
-----------	--------------	---	-----------

1471D2

Outil pour le recul des pistons de freins à disque
avec pinces fermées
double couple de plaques pour travailler sur pinces à 2 et 4 pistons



mm 10 CHF 103.00 1 014710301

250x170x60 mm 1,5 kg

1471T/C5

Jeu de 5 clés pour étriers de frein de camion

Peut être utilisé avec des clés dynamométriques pour les opérations de serrage tailles incluses:

- clés Torx femelles E18, E20, E24
- clés polygonales M24, M26



1471T/C5 CHF 330.00 1 014710400

275x220x60 mm - 3,1 kg

1472

Pince pour colliers auto-serrants



1472 CHF 58.00 1 014720001

1472AU

Pince automatique pour colliers auto-serrants



mm 18÷53 CHF 170.00 1 014720100

1472R/AU

Embout pour pince 1472AU



1472R/AU CHF 65.00 1 014720101

1472AU/P

Pince automatique à prise déportée pour colliers auto-serrants



mm 18÷54 L mm 630 CHF 149.50 1 014720105

1472AU/RP

Câble pour pince 1472AU/P



1472AU/RP CHF 36.50 1 014720106

1472B/RNLT

Douille à double tête, spécialement conçue pour les colliers de serrage d'aspiration installés sur les moteurs Renault



1472B/RNLT CHF 23.70 1 014720250

1472FC

Pince à têtes pivotantes, pour colliers CLIC(R)



1472FC CHF 54.00 1 014720090

1472FC/GE

Pince grande-amplitude pour colliers Clic (R)

Particulièrement indiquée pour les colliers de grandes dimensions



L mm 230 CHF 94.00 1 014720093

1472FC/L

Pince avec rallonge flexible, pour colliers Clic®



L mm 630 CHF 144.00 1 014720095

1472FCL/RP

Câble pour pince 1472FC/L



1472FCL/RP CHF 64.00 1 014720096

1472FCA

Pince pour démonter les colliers avec crémaillère type Visa®



1472FCA CHF 81.00 1 014720041

1472H

Outil pour démonter les colliers Henn



1472H	L mm 100	CHF 31.50	1	014720000
-------	----------------	--------------	---	-----------

1472MT/VW

Paire d'agrafes de décrochage des collecteurs d'aspiration pour les moteurs du Groupe VAG

Utilisable sur moteurs turbo essence 1.0 - 1.2 - 1.4



1472MT/VW	CHF 15.40	1	014720500
-----------	--------------	---	-----------

1472TM

Pince pour débrancher les raccords rapides des filtres Multijet



1472TM	CHF 38.00	1	014720200
--------	--------------	---	-----------

1472VW

Pince à têtes pivotantes, pour colliers auto-serrants
Pour voitures Volkswagen et Mercedes



1472VW	CHF 60.50	1	014720051
--------	--------------	---	-----------

1473

Pince pour colliers OETIKER®



1473 275	CHF 167.50	1	014730001
----------	---------------	---	-----------

1473A

Pince pour colliers OETIKER®



1473A	CHF 127.00	1	014730010
-------	---------------	---	-----------

1473P

Pince pour colliers OETIKER® pinçables à profil bas



1473P	A Max mm 53	CHF 47.00	1	014730020
-------	-------------------	--------------	---	-----------

1473FN

Outil de serrage et coupe des colliers en acier inox

Utilisable avec colliers Panduit(R) et similaires



1473FN	A mm 4,7÷9,5	CHF 87.50	1	014730051
--------	-----------------	--------------	---	-----------

1473T

Pince coupante pour enlever les colliers de cardan en acier

Permet de couper les colliers sans risque d'endommagement du soufflet



1473T	A Max mm 14	L mm 220	CHF 79.50	1	014730582
-------	-------------------	----------------	--------------	---	-----------

1474/C4

Kit 4 outils pour extraction bobines de bougies Volkswagen



1474/C4	CHF 132.50	1	014740100
---------	---------------	---	-----------

290x190x50 mm - 1 kg

1474E/VW

Extracteur à expansion pour bobines de bougies groupe Volkswagen



1474E/VW	CHF 36.50	1	014740120
----------	--------------	---	-----------

1474E/VW2

Extracteur pour bobines de bougies groupe VAG

Utilisable sur moteurs 1.0 - 1.2 - 1.4 - 2.0



1474E/VW2	CHF 44.50	1	014740150
-----------	--------------	---	-----------

1474L

Pince pour connecteurs de bougies à becs long coudés à 15°

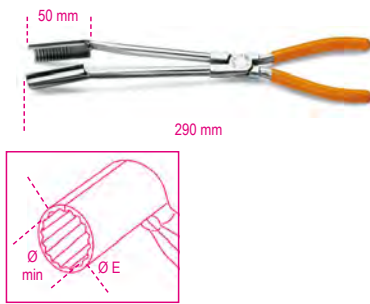

Ø min mm	Ø E mm	CHF		
14	20	106.50	1	014740010

1474DL

Pince pour connecteurs de bougies à becs long, branches gainées par 2 couches de PVC



CHF		
51.50	1	014740015

1474G

Pince à becs longs coudés pour capuchons des bougies de préchauffage



CHF		
57.50	1	014740200

1475U

Pince universelle chromée polie avec prise type "pistolet", branches gainées par 2 couches de PVC

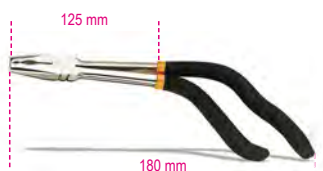

CHF		
54.00	1	014750010

1476

Pince-étau coupe-tubes d'échappement



Ø min mm	Ø max mm	L mm	CHF	
19	75	225	103.00	1 014760002

1476/RC

Chaîne pour 1476



CHF		
51.00	1	014760012

1476A

Pince coupe-tubes d'échappement



Ø min mm	Ø max mm	CHF	
30	95	131.00	1 014760005

1476A/RC

Chaîne pour 1476A



CHF		
112.00	1	014760015

1476C/1

Expandeur de tube d'échappement



CHF		
49.50	1	014760101

1476C/1
Ø 30=42 mm
L = 131 mm
L1 = 51 mm

1476GT

Pince pour l'extraction des supports en caoutchouc pour tubes d'échappement



L mm	A Max mm	3 mm	CHF	
280	58	3	45.00	1 014760050

1476PSA

Pince coupe-tubes d'échappement avec pivot, groupe PSA

La forme des becs et le blocage automatique de la crémaillère permet d'intervenir sans ôter l'embout



L mm	A Max mm	S mm	CHF	
309	60	12,2	56.00	1 014760060

1476T

Clé pour démontage/montage turbines sur moteurs Diesel, groupe Volkswagen Audi



mm	CHF	
12	51.00	1 014760200

1477/C10

Clé coudée avec 9 embouts pour écrous tendeur de courroie

1 clé coudée avec entraînements pour embouts
4 embout 12 pans doubles : 12x14 - 13x15 - 16x17 - 18x19 mm
5 embouts pour vis Torx® : E10 - E12 - E14 - E16 - E18



CHF		
215.00	1	014770310

530x110x55 mm

1477D

Clés 12 pans
pour écrous tendeurs de courroie



mm	CHF		
13	38.50	1	014770113
15	38.50	1	014770115
16	38.50	1	014770116
17	38.50	1	014770117
19	38.50	1	014770119

1477D/S5

Jeu de 5 clés 12 pans pour écrous tendeurs de courroie



	CHF		
1477D/S5 13-15-16-17-19 mm	192.00	1	014770200

600x200x70 mm - 2,2 kg

1477K/7

Kit clé à cliquet coudée réversible avec embouts



- 2 embouts TORX T40-T45
- 1 embout XZN 10
- 1 embout 6 pans 8 mm
- 3 embout 12 pans 10-12-13 mm

L mm	CHF		
1477K/7 250	188.00	1	014770051

1478

Pince d'extraction de clips



	CHF		
1478	74.50	1	014780001

1478NSS

Pince pour clips plastique avec 3 points de déblocage



L mm	CHF		
1478NSS 180	54.00	1	014780163

1478T

Pince à tête pivotante pour clips en plastique avec clips à pression

Tête pivotante à 90°



S mm	CHF		
1478T 4,5	58.00	1	014780101

1478/3P

Pince pour clips en plastique avec 3 points de déblocage



	CHF		
1478/3P	82.50	1	014780151

1478/K3

Lot de pinces pour clips avec assortiment de clips plastique

Le kit comprend :

- 1 pince à becs droits
- 1 pince à becs coudés à 90°
- 625 clips en plastique de 16 tailles différentes
- clips contenus dans 3 boîtes en PPL empilables



L mm	L1 mm	CHF		
1478/K3 180	170	135.00	1	014780160

1479

Spatule d'extraction de clips

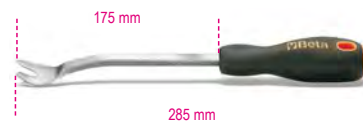

	CHF		
1479	33.00	2	014790001

1479/B27

Kit de 27 outils en nylon pour le démontage des plastiques intérieurs. Aucun endommagement des éléments au démontage. Dans un sac pouvant être suspendu



	CHF		
1479/B27	103.00	1	014790407

1479LB/C5

Kit de 5 spatules d'extraction de clips en métal



	CHF		
1479LB/C5	140.00	1	014790150

215x165x50 mm

1479L/S2

Paire de leviers multifonctions en Teflon®



	CHF		
1479L/S2	47.00	1	014790510

1479LV/S3

Kit de 3 leviers multifonctions en métal

Mesures :

1479LV/1 : 10x12 mm
1479LV/2 : 4,8x9,6 mm
1479LV/3 : 2,8x6 mm



1479LV/S3 CHF 39.50 1 014790100

1479L/K4

Kit de 4 spatules pour le démontage du tableaux de bord et des pièces délicates



1479L/K4 CHF 44.50 1 014790604

1479ML/B17

Kit de 17 leviers multifonctions en matière plastique

Particulièrement indiqués pour les travaux de précision



1479ML/B17 CHF 84.50 1 014790700

1479ML/S3

Kit de 3 leviers multifonctions en matière plastique

Particulièrement indiqués pour les travaux de précision



1479ML/S3 CHF 14.40 1 014790603

1479N/S5

Kit de 5 spatules d'extraction de clips pour carrossiers en nylon



1479N/S5 CHF 53.50 1 014790251

1479RB/1

Grattoir à ébarber droit



1479RB/1 CHF 36.50 1 014790315

1479RB/2

Grattoir à ébarber coudé



1479RB/2 CHF 36.50 1 014790320

1479RB/3

Grattoir à ébarber plat



1479RB/3 CHF 41.50 1 014790310

1479U/13

Spatule d'extraction de clips pour carrossiers en acier inoxydable



1479U/13 CHF 33.50 2 014790010

1479U/32

Spatule d'extraction de clips pour carrossiers en acier inoxydable



1479U/32 CHF 39.50 2 014790015

1480

Kit de remplissage pour filtres gazoil pour voiture sans pompe électrique

- Utilisable également avec pistolet de gonflage des pneumatiques

Le kit comprend :

- attaches rapides GM
- attaches rapides Renault, GM, Fiat Ø interne 6 mm
- attaches rapides Renault, GM, Fiat Ø interne 7 mm
- attaches rapides Ford
- attaches rapides PSA Ø interne 6 mm
- attaches rapides PSA Ø interne 7 mm
- attaches



1480 CHF 498.00 1 014800010

410x320x70 mm

1481/C12

Kit de 6 paires de pinces à durites

- 2 différentes paires de pinces dimensions 1/4"
- 2 différentes paires de pinces dimensions 3/8"
- 2 différentes paires de pinces dimensions 5/16"
- 3 paires de bouchons en caoutchouc



1481/C12 CHF 157.50 1 014810312

370x270x59 mm

1481K/S4

Kit de 4 presses auto-serrantes pour occlusion lignes

Mesures : 5/16" - 3/8" - 1/2" et passant



1481K/S4 CHF 39.50 1 014810400

1481PL/A

Pince à durites

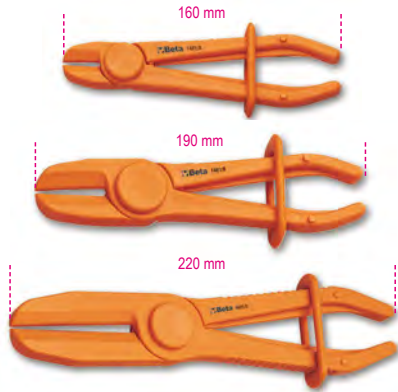

	Ø mm	CHF		
1481PL/A	8÷15	27.00	3	014810110
1481PL/B	15÷25	30.00	3	014810120
1481PL/C	25÷45	41.00	3	014810130

1481PL/S3

Jeu de 3 pinces à durites



1481PL/S3 CHF 98.00 1 014810200
 1481PL-A Ø 8÷15 mm
 1481PL-B Ø 15÷25 mm
 1481PL-C Ø 25÷45 mm

1481T/C12

Ensemble de bouchons pour conduite de carburant

3 paires de fiches avec raccords rapides mâle / femelle pour fermer les conduites de carburant



1481T/C12 CHF 163.00 1 014810212
 275x220x45 mm - 540 g

1482

Clé réglable autoserrante pour bouchon de trappe de réservoirs



Ø mm	CHF		
89÷170	146.50	1	014820001
89÷200	153.00	1	014820002

1482A/1

Clé à 3 pattes pour bouchon de trappe de réservoir avec bouchon en aluminium

Pour agir sur le bouchon en aluminium monté depuis 2011 sur les automobiles des groupes Fiat, Volkswagen, Opel, Chevrolet, Mercedes et BMW



Ø mm	CHF		
185	101.50	1	014820005

1482A/3

Clé pour bouchons de trappe de réservoir groupe PSA

Le dessin permet d'intervenir sur l'axe décentré en enlevant le bouchon, sans endommager le délicat flotteur



Ø mm	CHF		
157	115.50	1	014820007

1482A/5

Clé pour bouchons de trappe de réservoir à 22 secteurs

Pour agir sur le bouchon en plastique monté sur les automobiles du groupe VAG



Ø mm	CHF		
180	88.50	1	014820015

1482/8 - 1482/10

Pince pour raccords d'essence Renault



Ø mm	CHF		
8	51.00	2	014820008
10	51.00	2	014820010

1482B

Pince pour raccords d'essence



CHF		
60.50	1	014820021

1482SN

Pince pivotante à mâchoires articulées pour les raccords rapides des conduites de carburant



L mm	CHF		
260	77.50	1	014820110

1482C

2 couples de coins pur décrochage raccords filtres gasoil groupes Fiat, Volkswagen, Jeep, Chrysler et Volvo

Remplacement rapide du filtre sans endommager irrémédiablement les raccords



1482C CHF 80.50 1 014820022

1482D

Pince avec rallonge flexible pour raccords rapides tuyaux carburant



1482D CHF 110.50 1 014820026

1483K/12

Kit de démontage des soupapes installation de climatisation avec séries d'embouts à cinq pointes

Compris dans le kit :

- 2 douilles femelles 8 pans Ø 12 et 15 mm pour soupapes haute pression
- 2 douilles mâles à cliquet section 2,2 et 3,2 mm pour soupapes papillon
- 1 série d'embouts à cinq pointes taille : PT10, PT15, PT20, PT25, PT27, PT30, PT40



1/4"

1/4"



1483K/12 CHF 53.50 1 014830012

120x80x35 mm

1483KV-PT/S7

Jeu d'embouts à cinq pointes

Mesures comprises :

PT10 - PT15 - PT20 - PT25 - PT27 - PT30 - PT40



1/4"



1483KV PT/S7 CHF 16.10 1 014830117

1483K/22

Kit pour la séparation des raccords sur installations de climatisation, alimentation et lubrification



1483K/22 CHF 183.00 1 014830022

300x230x55 mm - 1 kg

1484

Jeu de 2 outils pour la dépose et le montage des courroies élastiques

Facilite la dépose et assure un montage correct de la courroie élastique sans risque d'endommagement



1484 CHF 162.00 1 014840010

1484PSA

Outil pour le montage de la courroie élastique de la pompe d'eau sans tendeurs de courroie

Utilisable pour groupe PSA et Opel moteurs 1.0 - 1.2



1484PSA CHF 21.10 1 014840012

1485BP

Outil en demi-lune pour bloquer les poulies d'arbre à cames

Manche réglable, serre et bloque la poulie de l'extérieur en évitant les dommages aux capteurs environnants



A Max mm 130 CHF 288.00 1 014850000

1485BPM

Outil en demi-lune avec mâchoires en aluminium pour blocages des poulies multi-gorges

Réglable par le manche rotatif, serre et bloque la poulie de l'extérieur, évitant ainsi les dommages des capteurs environnants



A Max mm 180 CHF 248.50 1 014850002

1485FCA/K2

Paire d'outils pour la précharge des galets tendeurs de distributions du groupe FCA

Indiqués pour moteurs 1.2, 1.4 8/16 V et 1.4 Multiair

- 1 outil longueur 175 mm avec embouts de 13,5 mm
- 1 outil longueur 305 mm articulé avec embouts de 13,5 mm



1485FCA/K2 CHF 132.00 1 014850220

1485FCA/T

Outil tendeur long pour roulements distribution avec embouts de 13,5 mm



L mm 175 P mm 13,3 CHF 47.50 1 014850210

1485FCA/TS

Tendeur articulé pour roulements distribution avec embouts de 13,5 mm



L mm 305 P mm 13,5 CHF 84.50 1 014850215

1485FRD/T

Levier pour la dépose des courroies d'accessoire montées sur moteurs Ford Utilisable pour le retrait des poulies des alternateurs



L mm 450 Q mm 12,80 CHF 103.00 1 014850310

1485MRC/T

Levier pour la dépose des courroies d'accessoires, montées sur moteurs Mercedes
Utilisable pour moteurs M133 - M270

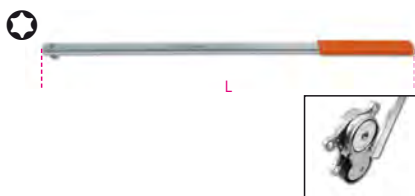

L mm 510
T55
CHF 42.00 1 014850315

1485VLV/T

Levier pour la dépose des courroies accessoire, montées sur moteurs Volvo

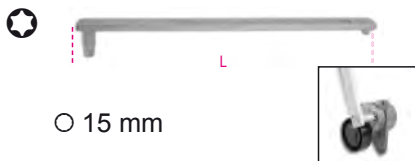

L mm 420
T50-T60
Ø mm 15
CHF 87.00 1 014850320

1485TC

Levier pour la dépose des courroies d'accessoire, montées sur moteurs Ford, PSA, FCA



L mm 475
CHF 62.50 1 014850330

1485/KIT

Kit de tensiomètres de courroie de distribution



1485/KIT CHF 233.50 1 014850100

230x140x75 mm - 580 g

1485MJ

Outil de blocage de l'arbre à came des moteurs 1.3 16V Multijet

2 têtes avec 3 profils pour intervenir sur tous les moteurs 1.3 16V Multijet
montés par le groupe FCA, Opel, Ford et Suzuki

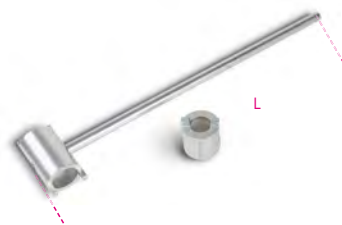

L mm 500
CHF 162.00 1 014850150

1485PMTJ

Levier d'immobilisation pour les poulies d'arbre à came des moteurs Multijet
Géométrie expressément étudiée pour bloquer l'arbre moteur pendant les opérations de retrait de la poulie



L mm 450
CHF 168.50 1 014850190

1485R

Outil pour la rotation de poulies de distribution en acier forgé
fourni avec 2 paires d'embouts



Ø mm 30÷120
Ø1 mm 10 - 17
L mm 500
CHF 201.50 1 014850025

1485R/P10

Paire d'embouts



1485R/P10 CHF 21.60 1 014850035

1485R/P17

Paire d'embouts



1485R/P17 CHF 21.60 1 014850038

1485VAG/K2

Clés pour précharger les galets-tendeurs de distribution

- Tête orientable en 3 positions
- 1 outil avec tête profonde 12,5 mm
- 1 outil avec tête profonde 21,5 mm



1485VAG/K2 CHF 100.50 1 014850080

1485VAG

Clé pour précharger les galets-tendeurs de distribution

- Tête orientable en 3 positions



L mm 190
P mm 12,5
CHF 49.50 1 014850062
L mm 195
P mm 21,5
CHF 51.00 1 014850071

1486/10

Clé pour vannes de réservoirs méthane

- group VW à partir de 2008
- Panda de 2004 à 2012
- Grande Punto de 2005 à 2012
- Ducato à partir de 2010
- nouvelles Doblò et Combo
- Cubo et Fiorino



36 mm

1486/10 CHF 181.50 1 014860110



1486/20

Clé pour vannes de réservoirs méthane

- Multipla
- Ducato 1ère et 2ème série jusqu'à 2010
- Berlingo et Ranch
- C3 avec bouteilles en fer
- Punto de 1999 à 2010
- Doblò 1ère série
- Daily et groupe Iveco
- Dr5

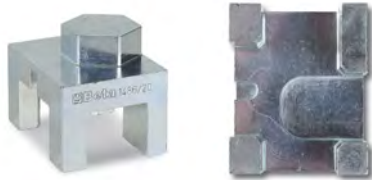

⊘ 36 mm

1486/20 CHF 181.50 1 014860120

1486/30

Clé pour vannes de réservoirs méthane

- Zafira 2ème série
- Combo 1ère série



⊘ 36 mm

1486/30 CHF 181.50 1 014860130

1486/40

Clé pour vannes de réservoirs méthane

- Touran 1ère série

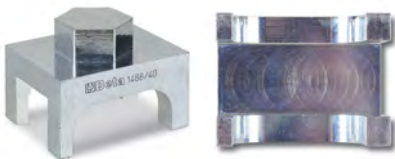

⊘ 36 mm

1486/40 CHF 181.50 1 014860140

1486/50

Clé pour vannes de réservoirs méthane

- Panda à partir de 2012
- Nouvelle Ypsilon



⊘ 36 mm

1486/50 CHF 181.50 1 014860150

1486/60

Clé pour vannes de réservoirs méthane

- C4 Picasso
- installations BRC



⊘ 36 mm

1486/60 CHF 181.50 1 014860160

1486/70

Paire de clés pour vannes de réservoirs méthane

- C3 avec bouteilles en composite



⊘ 36 mm

1486/70 CHF 374.00 1 014860170

1486/80

Clé pour vannes de réservoirs méthane

- Classe B
- Zafira 3ème série

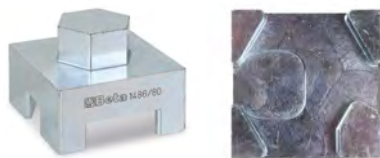

⊘ 36 mm

1486/80 CHF 181.50 1 014860180

1486/90

Clé pour vannes de réservoirs méthane

- Zafira 1ère série
- Kangoo 1ère série
- Sprinter

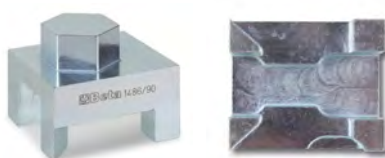

⊘ 36 mm

1486/90 CHF 181.50 1 014860190

1487/K2

Jeu de 2 prises pour bouchons de vidange de radiateur



17 mm

1487/K2 CHF 36.00 1 014870100

1488 - 1488L

Clé à chaîne pour filtres à huile



	∅ mm	CHF		
1488	60÷110	119.50	1	014880001
1488L	60÷160	131.50	1	014880050

1488/1

Clé à chaîne pour filtres à huile



	∅ mm	CHF		
1488/1	60÷110	139.00	1	014880010

1488R...

Chaîne de rechange



			CHF		
1488RC	1488	350	49.50	1	014880101
1488R/L	1488/L	520	79.50	1	014880150
1488RC/1	1488/1		68.00	1	014880110

1489/31T

Clé pour les poulies libres des alternateurs



	T50	15	31	CHF		
1489/31T				51.00	1	014890016

1489/33

Clé pour le remplacement des poulies d'alternateur



		CHF		
1489/33	33	21.60	1	014890010

1489/33P

Clé pour le remplacement de la poulie
nouvel alternateur Bosch
FIAT Grande Punto



12"
 M 10 Ø mm 15 31 CHF 64.50 1 014890015

1489/E

Clé pour les poulies libres des alternateurs

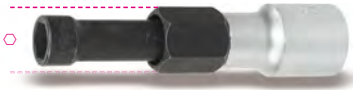

Ø mm 10 Ø mm 15 CHF 43.50 1 014890025

1489R

Clé pour le remplacement des poulies
d'alternateur

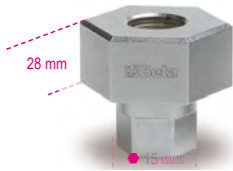

1489/R CHF 21.60 1 014890020

1489/Y

Clé pour le remplacement des poulies
alternateurs Nippondenso



Ø mm 32 CHF 24.80 1 014890040

1489/C14

Composition de 14 outils pour les poulies
libres des alternateurs



1489/C14 CHF 386.00 1 014890100

- Ø 867PE 8 mm
- Ø 867PE/L 8 mm
- Ø 867XZN/L M10
- Ø 867TX/L T50
- 867/2 □1/2"
- Ø 920B 10 mm
- 1489/33
- 12" 1489/33P M10
- 1489R
- 1489/Y
- 1489/31T T50
- 1489/E 10 mm
- 188 10 mm
- 188 15 mm

420x250x45 mm - 1,9 kg

1490

Clé à sangle pour filtres à huile



Ø max mm CHF 1 014900001
1490/1 160 47.50
1490/2 240 51.50 1 014900002

1490/R1 - 1490/R2

Sangle en tissu pour 1490



Ø mm CHF 1 014900101
1490R/1 160 23.20
1490R/2 240 28.50 1 014900102

1490F

Clé à sangle pour filtres



38" 12" Ø Max mm 200 CHF 34.50 1 014900201

1491

Clé à sangle pour filtres à huile



Ø mm 65-110 CHF 62.00 2 014910001

1491R

Sangle pour 1491



1491R CHF 11.30 10 014910010

1491A

Pince réglable pour filtres à huile

Réglage de précision par crémaillère



L mm 345 Ø min - Max mm 55 ÷ 140 CHF 42.00 1 014910040

1491T

Pince réglable pour filtres à huile des poids
lourds

Réglage de précision par crémaillère
Utilisable pour filtres dessiccateurs



L mm 500 Ø min - Max mm 70 ÷ 200 CHF 98.50 1 014910050



1492/1 - 1492/2

Clé réglable pour filtres à huile



	Ø mm	CHF		
1492/1	60÷80	59.00	1	014920001
1492/2	80÷110	61.50	1	014920002

1492T

Clé pour filtres sécheurs



	Ø mm	H mm	CHF		
1492T 40	125÷145	40	45.00	1	014920540
1492T 75	120÷140	75	79.50	1	014920575

1493B

Clé polygonale pour cartouches des filtres à huile difficiles d'accès



mm	± mm	CHF		
24	8	25.50	1	014930524
27	8	26.50	1	014930527
32	8	27.00	1	014930532
36	8	29.00	1	014930536
38	8	29.50	1	014930538

1493B/S5

Jeu de 5 clés polygonales pour cartouches des filtres à huile difficiles d'accès

Dimensions :
24-27-32-36-38 mm



	CHF		
1493B/S5	104.50	1	014930599

1493

Clé pour filtres à huile



Ø mm	N	CHF		
65	14	14.40	1	014930200
68	14	14.40	1	014930206
73	14	14.40	1	014930208
74	14	14.40	1	014930209
74	15	14.40	1	014930210
75-77	15	14.40	1	014930212
76	8	14.40	1	014930214
76	14	14.40	1	014930218
76-74	15	15.60	1	014930220
78	15	15.60	1	014930224
80	15	16.00	1	014930226
82-80	15	16.00	1	014930228
86	16	17.00	1	014930230
90	15	17.00	1	014930234
92	10	17.00	1	014930236
93	15	17.00	1	014930238
95	15	17.00	1	014930244
100	15	19.40	1	014930248
106	15	20.10	1	014930250
108	15	20.10	1	014930252
135	18	32.00	1	014930256

1493/PF

Clé pour filtres à huile spéciale Purflux®



Ø mm	N	CHF		
66	6	14.40	1	014930202
76	12	14.40	1	014930216
76	30	15.60	1	014930222
86	18	17.00	1	014930232
93	36	17.00	1	014930240
93	45	17.00	1	014930242
96	18	17.00	1	014930246
108	18	21.60	1	014930254



1493/C30

Jeu de 28 clés pour filtres à huile



Mesures incluses dans le kit (Ø mm / n° de côtes)

1493:

65/14 - 67/14 - 68/14 - 73/14 - 74/15
76/15 - 75.77/15 - 76/14 - 76/8 - 78/15 - 80/15
82/15 - 86/16 - 90/15 - 92/10 - 93/15 - 95/15
100/15 - 106/15 - 108/15

1493PF (Purflux)

66/6 - 76/12 - 76/30 - 86/18

93/36 - 93/45 - 96/18 - 108/18

- Avec 1 clé réglable universelle
Ø 65÷120 mm

	CHF		
1493/C30	350.00	1	014930000

530x400x110 mm - 4 kg

1493AL

Clé pour filtres à huile

N= N côtes



Ø mm	N	●	□	CHF		
64	14	27	1/2"	21.60	1	014930310
66,5	14	27	1/2"	19.40	1	014930315
74	14	27	1/2"	23.40	1	014930320
79	15	27	3/8"	21.60	1	014930325
84	14	27	3/8"	23.40	1	014930330
87	16	27	1/2"	29.00	1	014930335
92	15	27	3/8"	23.40	1	014930340
94,5	15	27	3/8"	23.40	1	014930345
100,5	15	27	3/8"	23.40	1	014930350

1493AL 4S

Clé pour filtres à huile pour les automobiles asiatiques
Profil à 4 ergots



Ø1 mm	Ø2 mm	CHF		
70	64,5	27	23.40	1 014930304
80	64,5	27	21.60	1 014930305

1493AL CF

Douille 6 pans
pour cartouches filtrantes d'huile



Ø mm	H mm	CHF	1	014930424
24	34	27	13.90	1 014930424
27	34	27	13.90	1 014930427
30	34	27	13.90	1 014930430
32,5	34	27	14.40	1 014930432
36	34	27	14.40	1 014930436
38	34	27	14.40	1 014930438

1493/C19

Jeu de 18 clés pour filtres à huile.
Particulièrement indiquées pour les
automobiles asiatiques

Ø mm	N côtés
63-64	14
66,5	14
74	14
79	15
84	14
87	16
92	15
94,5	15
100,5	15
64,5	14 à ergot pour Toyota
64,5	14 à ergot pour Lexus
6 douilles 6 pans taille 24-27-30-32,5-36-38 mm pour cartouches filtrantes	
Le kit comprend 1 clé universelle réglable Ø 58÷93 mm	



1493/C19 CHF 306.00 1 014930019

490x450x60 mm - 4 kg

1493DSG

Clé pour démontage/montage
filtre à huile boîte de vitesse DSG



Ø mm 24 CHF 48.50 1 014930800

1493FF

Clé pour démontage/montage de la pièce en
plastique des
filtres à huile Ford Peugeot Citroën
moteurs : TDCi-HDi

Permet de serrer correctement la pièce en plastique
avec clés dynamométriques à 25 Nm



Ø mm 27 CHF 39.50 1 014930127

1493FT

Clé pour filtres gasoil Ford Transit

Utilisable sur toutes les versions
Transit, Transit Custom et Tourneo Custom
depuis 2012

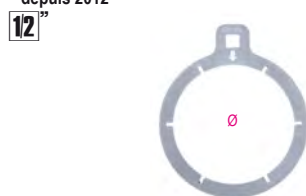

Ø mm 115 CHF 33.50 1 014930085

1493J

Clé pour filtres diesel Multijet

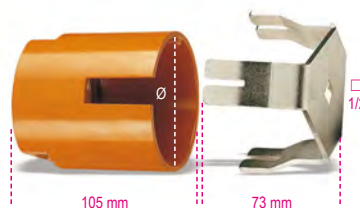

Ø mm 90 CHF 153.00 1 014930080

1493VV

Clé pour filtres diesel
groupes VAG et Volvo



Ø mm 82,5 CHF 22.30 1 014930086

1493HK

Clé de filtre à huile diesel pentadécagonale
pour Hyundai Kia



1493HK CHF 36.00 1 014930087

1493/C7

Clé autoréglable à trois bras
pour filtres à huile, serrage à droite-gauche,
avec bras interchangeables

Finition diamantée antiglisse

2 séries de bras :

- 1 série avec longueur utile 20 mm
- 1 série avec longueur utile 38 mm



1493/C7 Ø mm 50÷100 Ø mm 16 CHF 148.00 1 014930079

210x150x50 mm

1493H

Clé autoréglable à trois bras
pour filtres à huile, serrages à droite-gauche

Griffes moletées

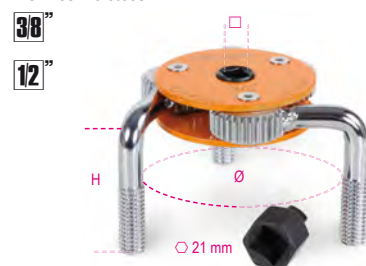

1493H Ø mm 72÷127 H mm 62 CHF 36.50 1 014930077



1493/S-U

Clé auto-serrante à 3 bras pour filtres à huile (serrages et desserrages)



	□	∅ mm	CHF		
1493/S	3/8-1/2	80-115	111.00	1	014930074
1493/U	1/2	105-165	243.00	1	014930076

1493X

Clé auto-serrante pour filtres à huile, serrages à gauche

38"



	∅ mm	± mm	CHF		
1493X/1	60÷80	2,9	42.00	1	014930105
1493X/2	80÷98	2,9	42.00	1	014930110

1493Y

Clé auto-serrante pour filtres à huile, serrages à droite et gauche, pour poids-lourds.

L'article 1493Y/2 est utilisable également pour les filtres sécheurs

12"



	∅ mm	± mm	CHF		
1493Y/1	80÷110	7,3	144.00	1	014930120
1493Y/2	104÷145	7,3	219.50	1	014930122

1493C/ADB

Douille pour ouvrir les bouchons AdBlue®, des véhicules du groupe PSA

38"



	CHF		
1493C/ADB	21.80	1	014930900

1493U/ADB

Clé pour ouvrir les bouchons de vidange AdBlue®

38"



	CHF		
1493U/ADB	15.80	1	014930910

1494T/C5

Jeu de 4 douilles spéciales pour bouchons de vidange d'huile en plastique + 1 clé en "T"

Contenu du set:

- 1 douille pour bouchons de vidange d'huile groupe VAG
- 1 douille pour bouchons de vidange d'huile BMW
- 1 douille pour bouchons de vidange d'huile PSA et groupe Ford
- 1 douille pour bouchons de vidange d'huile Mercedes
- 1 clé à poignée en "T"

38"



	CHF		
1494T/C5	95.50	1	014940350

173x125x50 mm - 360 g

1494BMW

Clé spéciale pour bouchons à huile en plastique moteurs BMW

38"



	CHF		
1494BMW	18.50	1	014940315

1494FPC

Clé spéciale pour bouchons à huile en plastique moteurs Ford, Peugeot, Citroën

38"



	CHF		
1494FPC	20.80	1	014940320

1494VW

Clé spéciale pour bouchons à huile en plastique moteurs groupe Volkswagen

Permet d'ôter et d'installer le bouchon en plastique de la cuve à huile. Spécifique pour les automobiles du groupe Volkswagen avec moteurs TFSI et TDI

38"



	CHF		
1494VW	29.00	1	014940305

1494MRC

Douille spéciale pour les bouchons de vidange d'huile en plastique, spécifique moteurs Mercedes

38"



	CHF		
1494MRC	20.30	1	014940325

1494MAN

Douille spéciale pour les bouchons de vidange d'huile en plastique, spécifique moteurs DAF et MAN

38"



	CHF		
1494MAN	20.30	1	014940330

1494

Douille carrée pour bouchons de vidange moteur

12"



mm	CHF		
10	12.10	1	014940280

1494E

Douille mâle 6 pans pour bouchons de vidange moteur

12"



mm	CHF		
8	12.10	1	014940208
9	12.10	1	014940209
10	12.10	1	014940210
11	12.10	1	014940211
12	12.10	1	014940212
14	12.10	1	014940214
17	12.10	1	014940217

 Beta

1494Q

Douille mâle carrée pour bouchons de vidange moteur

12"



mm	CHF		
8	12.10	1	014940258
9,5	12.10	1	014940259
12	12.10	1	014940262
13	12.10	1	014940263

1494T

Douille mâle triangulaire pour bouchons de vidange moteur

12"



mm	CHF		
9,5	12.10	1	014940289

1494XZN

Douille mâle bouchons pour vidange moteur XZN®

12"



M	CHF		
16	14.40	1	014940296

1494VW/K

Kit pour le remplacement de l'huile des moteurs du Groupe VAG



Le kit comprend :

- 1 clé spéciale pour bouchons en plastique
- 6 bouchons en plastique pour coupe

1494VW/K	CHF		
	38.00	1	014940310

1494VW/KT

Kit de 6 bouchons plastiques pour 1494VW/K



1494VW/KT	CHF		
	33.00	1	014940311

1494/C14A

Composition de 14 outils pour vidange

12"



1494/C14A	CHF		
	173.00	1	014940150

- 1494E 8-9-10-11-12-14-17
- 1494Q 8-9,5(3/8")-12-13
- 1494 10
- △ 1494T 9,5(3/8")
- 1494XZN M16

380x305x40 mm - 1,7 kg

1494M

Outil pour bouchons à huile hexagonaux magnétique et flexible

Permet de dévisser le bouchon sans risques de brûlure et sans salissures



L	F	Ø	CHF		
mm	kg	mm	31.00	1	014940401
293	2,5	19			

1495/C6

Composition d'outils pour la réparation des filetages du carter d'huile



• Le filet endommagé est éliminé par le foret taraudeur et élargi d'une mesure

• Répare le carter d'huile et évite ainsi de le remplacer

- Contenu :
- 1 taraud mâle M13x1,25 + 6 vis + 12 rondelles
 - 1 taraud mâle M13x1,5 + 6 vis + 12 rondelles
 - 1 taraud mâle M15x1,5 + 6 vis + 12 rondelles
 - 1 taraud mâle M17x1,5 + 6 vis + 12 rondelles
 - 1 taraud mâle M20x1,5 + 6 vis + 12 rondelles
 - 1 taraud mâle M22x1,5 + 6 vis + 12 rondelles

1495/C6	CHF		
	374.00	1	014950500

420x185x60 mm - 2,1 kg

1495M

Taraud mâle pour filetages bouchons d'huile



M	CHF		
13x1,25	22.50	1	014950553
13x1,50	18.50	1	014950563
15x1,50	20.10	1	014950565
17x1,50	22.50	1	014950567
20x1,50	24.80	1	014950570
22x1,50	32.00	1	014950572

1495T

Kit de 6 bouchons d'huile et rondelles



M	CHF		
13x1,25	26.00	1	014950503
13x1,50	26.00	1	014950513
15x1,50	26.00	1	014950515
17x1,50	29.00	1	014950517
20x1,50	33.00	1	014950520
22x1,50	42.50	1	014950522

1496/C

Clé de vidange



8 x 10 mm	CHF		
	28.50	3	014960010

1497D

Pince à becs droits pour extraction relais



A	CHF		
min+Max mm	43.50	1	014970150
1497D	15±50		

1497BS

Pince à becs droits et fins pour extraction relais et fusibles

Les becs longs et très fins permettent le prélèvement du relais et du fusible dans les espaces limités.

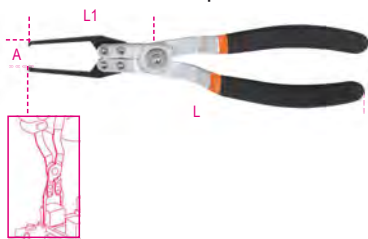

L mm	L1 mm	A mm	CHF		
230	45	14	30.00	1	014970190

1497P

Pince à becs coudés à 60° pour extraction relais



A min=Max mm	CHF		
15÷50	44.50	1	014970160

1497SS

Pince-étai pour le soudage de fils d'étain

Les clips supérieurs permettent de bloquer et rapprocher les fils à souder. La crémaillère intégrée permet de positionner les fils de six manières différentes.



L mm	A min=Max mm	CHF		
245	14÷70	27.50	1	014970195

1497TE

Pince pour déconnecter les connecteurs électriques

Le nez extrêmement fin permet de libérer les clips sans endommager les connecteurs



L mm	A Max mm	Ø mm	CHF		
215	63	4	31.00	1	014970180

1497/C23

Composition de 23 outils pour déblocage des connecteurs électriques



1497/C23	CHF		
	293.00	1	014970200

440x250x70 mm - 1,7 kg

1497/C94

Assortiment de 94 connecteurs pour test sur automobiles utilisables avec les principaux instruments de diagnostic

- 2 aiguilles de prise de tension
- 2 potentiomètres
- 2 voyants d'avertissement
- 2 connecteurs SRS
- 2 pinces crocodile
- 2 sondes à aiguilles
- 2 embouts
- 2 fiches banane 2 en 1
- 4 fiches banane 1 en 1
- 24 embouts mâle plats 0.6+6 mm
- 12 embouts mâle ronds 1.6+3.9 mm
- 24 embouts femelle plats 0.6+6 mm
- 12 embouts femelle ronds 1.6+3.9 mm



1497/C94	CHF		
	517.00	1	014970300

430x390x100 mm - 3 kg

1497RC

Paire de pique-fils pour prise de tension

- section câbles : 1,5+3,5 mm
- voltage : 0÷330V
- courant maximum : 5A



1497RC	CHF		
	98.00	1	014970351

1497KB/S3

Kit de 3 outils pour élimination connecteurs électriques Knorr et Bremse

- 1 outil pour connecteurs à baïonnette
- 1 outil avec empreinte pour connecteurs à 2 pôles
- 1 outil avec double empreinte pour connecteurs à 4 ou 6 pôles et 12 pôles



1497KB/S3	CHF		
	108.00	1	014970050

1497/S3

Jeu de 3 câbles pour lectures signaux électriques

- 1 pce droite
- 1 pce 45°
- 1 pce 90°



1497/S3	CHF		
	24.30	1	014970400

1498

Testeur de tension

CE

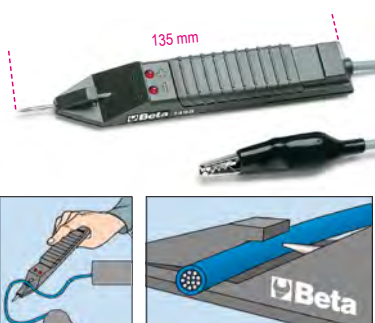

3÷48V	CHF		
	64.50	2	014980100

REPARATION DE VEHICULES

Nos outils de réparation de véhicules qui sont utilisés par les professionnels les plus exigeants, sont développés et fabriqués pour répondre aux normes les plus élevées du monde, et régulièrement testés dans les conditions de fonctionnement les plus difficiles.

Depuis plus de 50 ans, nous travaillons fièrement et en collaboration les plus grands champions des sport mécaniques, nous aidant à améliorer continuellement nos produits et témoignant du niveau de qualité PREMIUM.

Les outils de réparations de véhicules se trouvent dans les sections:

Diagnostics	articles 1438 to 1499 articles 1758VT to 1760TMC
Moteur	articles 955 to 989A articles 1438 to 1499
Vidange	articles 1438 to 1499 articles 1877 to 1885
Système électrique	articles 1438 to 1499
Boosters de démarrage	articles 1498BC/12 to 1498/40A
Transmission	articles 1438 to 1499
Suspension	articles 1549 to 1569CP
Freins	articles 1438 to 1499
Roues	articles 955 to 989A
Carrosserie	articles 1302 to 1369 articles 1763 to 1767A
Autres équipements	articles 1878 to 3067
Levage	articles 3029/2T to 3067/70-13T



1498BC/12

Booster de démarrage portable multifonction 12V

Données techniques :

- courant de démarrage : 600A
- courant de décollage : 1500A
- type de batterie : 4 cellules LifePo4
- capacité de la batterie : 25000mAh
- Dispositif de protection contre l'inversion de polarité, court-circuit, surintensité, surcharge et surtension thermique



CE



Équipement :

- Étui de protection
- Câble avec pince de démarrage
- Sorties USB pour charger des appareils électroniques
- Indicateur LED de charge de la batterie
- Câble USB et USB-C
- Alimentation secteur
- Torche LED multifonction

	L	P	H	CHF		
	mm	mm	mm			
1498BC/12	225	100	40	430.00	1	014980040

1498MN/12-C

Câble de démarrage avec pinces pour 1498BC/12



	CHF		
1498MN/12-C	77.00	1	014980005

1498MN/12-R

Alimentation secteur mini booster de démarrage 1498BC/12



	CHF		
1498MN/12-R	56.50	1	014980003

1498MN/12-P

Alimentateur prise auto mini booster de démarrage 1498BC/12



	CHF		
1498MN/12-P	34.00	1	014980004

1498MN/12-U

Câble USB avec adaptateur universel U



	CHF		
1498MN/12-U	24.90	1	014980009

1498LT/12

Booster de démarrage portatif ultra léger hautes performances



CE

Le microprocesseur permet une protection complète contre :

- inversion de polarité
- court-circuit
- voltage erroné
- surcharge
- sous-charge
- sur-décharge
- échauffement

DONNÉES TECHNIQUES

Tension d'utilisation : 12 V
Ampérage continu : 800 A
Ampérage maximum de mise en marche : 2000 A
Ampérage de pic : 4000 A
Longueur câbles : 500 mm
Type batterie : 4 cellules LifePo4
Fonction sauve-mémoire : SI
Dimensions : 260 x 135 x 72 mm
Poids net : 2.5 kg
Doté d'alimentateur de recharge 12 V 1,3A

	CHF		
1498LT/12	1,094.00	1	014980012

1498LT/12-SF

Étrier de fixation mural pour booster de démarrage 1498LT/12



	CHF		
1498LT/12-SF	181.50	1	014980013

1498LT/12-R7

Chargeur secteur pour booster de démarrage 1498LT/12



	CHF		
1498LT/12-R7	79.50	1	014980057

1498LT/12-24

Booster de démarrage portable ultra-léger à hautes performances, 12-24 V

Convient parfaitement pour une utilisation sur les voitures, les véhicules utilitaires et les Poids Lourds.



Le microprocesseur offre une protection totale contre:

- inversion de polarité
- des courts-circuits
- tension incorrecte
- surcharges
- sous-déchargement
- surcharge
- surchauffe

DONNÉES TECHNIQUES

- tension de fonctionnement: 12 / 24V
- ampérage continu: 2000/1000 A
- ampérage maximum de démarrage: 5000/2500 A
- ampérage de crête: 10000/5000 A
- ampérage de la pince: 1000 A
- longueur du câble: 160 cm
- section de câble: 25 mm²
- alimentation automatique: 4 Amp
- fonction d'économie de mémoire
- dimensions: 350x240x140 mm
- poids: 5 kg

1498LT/12-24 CHF 2,170.00 1 014980014

1498/12

Booster de démarrage 12 V portable



CARACTÉRISTIQUES TECHNIQUES :

- Courant de décollage 2200A
- Bandoulière de transport fournie
- Batterie hermétique au plomb, électrolyte solide (AGM)

1498/12 CHF 915.00 1 014980480

13 kg

1498/24

Booster de démarrage 12-24 V portable



CARACTÉRISTIQUES TECHNIQUES :

- Courant de décollage 4200A (12V) - 2100A (24V)
- Bandoulière de transport fournie
- Batterie hermétique au plomb, électrolyte solide (AGM)

1498/24 CHF 1,845.00 1 014980490

1498B12/R02

Batterie de recharge 12V pour boosters de démarrage 12-24V



1498B12-R02 CHF 398.00 1 014980502

1498/12-24 R20

Alimentation réseau pour boosters de démarrage

1498/12 et 1498/24



1498/12-24 R20 CHF 95.50 1 014980520

1498/2A

Chargeur de batterie électronique 12V pour motos

Permet la recharge de tous les types de batteries au Pb Wet, Agm, Gel, Mf, Vrla et des batteries au Lithium LiFePo4



- Deux types spécifiques de chargeur de batteries au Lithium et au Plomb
- Cycle de recharge multiphase automatique
- Protection contre l'inversion de polarité et les courts-circuits
- Degré de protection IP65
- Comprend câble avec pinces et câble avec embouts
- Tension d'alimentation : 220-240V

DONNÉES TECHNIQUES

- Courant de recharge : 1A
- Capacité de recharge : 2Ah-40Ah
- Fréquence : 50-60 Hz
- Tension de la batterie : 12V
- Dimensions : 180x80x40 mm
- Poids : 0,5 kg

1498/2A CHF 168.00 1 014980102

1498/4A

Chargeur de batterie électronique 6-12 V auto-moto



- Protection contre l'inversion de polarité et les courts-circuits
- Sélection automatique de la tension à 6 ou 12 Volts
- Sélection automatique du type de batterie
- Écran numérique et fond d'écran lumineux
- Crochet de fixation inclinable

DONNÉES TECHNIQUES

- Tension d'alimentation : 220V-240V
- Fréquence : 50-60 Hz
- Courant nominal (min-max) : 1-4 Amp
- Tension de la batterie : 6V/12V
- Capacité de la batterie : 4Ah-80Ah
- Temps de charge : 12 heures
- Degré de protection : IP65

1498/4A CHF 205.00 1 014980104

1498SA/2A-4A

Câble avec prise allume-cigares pour 1498/2A et 1498/4A



1498SA/2A-4A CHF 42.50 1 014980120

1498/8A

Chargeur de batterie électronique 12V auto / véhicules utilitaires



- charge lente et rapide (2A-8A)
- fonction récupération batteries déchargées
- fonction alimentateur 13,8V-5A
- protection contre l'inversion de polarité et les courts-circuits
- sélection manuelle du type de batterie
- écran numérique et fond d'écran lumineux
- crochet de fixation inclinable

DONNÉES TECHNIQUES

Tension d'alimentation : 220V - 240V
Fréquence : 50-60 Hz
Courant nominal (min-max) : 2-8 Amp
Tension de la batterie : 12V
Capacité de la batterie : 5Ah-160Ah
Fonction Memory Saver : 13,8V - 5A
Degré de protection : IP65

1498/8A	CHF 290.00		1	014980108
---------	---------------	--	---	-----------

1498/4A-8A CO

Câble à ceilllets pour 1498/4A et 8A



1498/4A-8A-CO	CHF 20.70		1	014980114
---------------	--------------	--	---	-----------

1498/4A-8A CP

Câble avec pinces pour 1498/4A et 8A



1498/4A-8A-CP	CHF 26.50		1	014980118
---------------	--------------	--	---	-----------

1498/2A-8A-PR

Rallonge pour 1498/2A/4A/8A



1498/2A-8A-PR	CHF 49.50		1	014980119
---------------	--------------	--	---	-----------

1498/16A

Chargeur de batterie électronique 12-24V multifonction



- Écran d'affichage graphique rétroéclairé
- Courant maximum de charge 16A en continu
- Charge et maintien
- Protection contre l'inversion de polarité, court-circuit
- 9 phases de recharge
- Floating system
- Fonction SHOW ROOM (13,8V - 12A)
- Fonction SUPPLY (14V - 12A)
- Fonction de sauvegarde de mémoire (13,8V - 12A)
- Fonction de récupération batteries
- Porte-pinces
- Crochet de fixation inclinable
- Accessoires inclus : câble avec pince, câble avec ceilllets

DONNÉES TECHNIQUES

Alimentation : 220-240V
Puissance : 240W
Courant de charge : 4-16A
Type batterie : Agm - Wet - Lithium (LiFePo4)
Capacité de charge : 5-360Ah
Capacité de maintien : 5-550Ah
Tension en sortie : 12-24V
Tension minimum batterie : 0,8V
Indice de protection : IP20

1498/16A	CHF 609.00		1	014980126
----------	---------------	--	---	-----------

1498/25A

Chargeur de batteries électronique 12-24 V multifonction



Caractéristiques :

- Écran d'affichage graphique rétroéclairé
- Courant maximum de charge 25A en continu
- Charge et maintien
- Protection contre les inversions de polarité et les court-circuits
- 9 phases de charge
- Floating system
- Fonction SHOW ROOM (13,8V - 21A)
- Fonction SUPPLY (14V - 21A)
- Fonction de sauvegarde de mémoire (13,8V - 21A)
- Fonction de récupération batteries
- Porte-pinces
- Crochet de fixation inclinable
- Accessoires inclus : câble avec pince

Données techniques :

Alimentation : 220-240V
Puissance : 390W
Courant de charge : 5-25A
Type batterie : Agm - Wet - Lithium (LiFePo4)
Capacité de charge : 5-550Ah
Capacité de maintien : 5-800Ah
Tension en sortie : 12-24V
Tension minimum batterie : 0,8V
Indice de protection : IP20

1498/25A	L mm H mm P mm	CHF 717.00		1	014980125
----------	----------------	---------------	--	---	-----------



1498/120A

Chargeur de batteries électronique 12 Volts multifonction

Permet la charge des batteries et le maintien de l'alimentation stabilisée pendant toutes les phases de reprogrammation et de diagnostics.



- courant maximum de charge 30 A continus
- charge et maintien avec microprocesseur CPU
- fonction récupération des batteries
- reprogrammation et alimentation ECU
- protection contre l'inversion des polarités, les courts-circuits, les voltages erronés et les surcharges

DONNÉES TECHNIQUES

Alimentation : 90-260V
 Puissance : 1500W
 Courant de charge: 10-120A
 Types de batteries : Agm - Wet - Lithium (LifePo4)
 Capacité de charge : 10-1200Ah
 Capacité de maintien : 5-3600Ah
 Tension en sortie : 12 Volts
 Longueur câbles avec pinces : 2700 mm
 Dimensions: 310 x 150 x 350 mm
 Peso: 8,5 Kg

1498/120A CHF 3,780.00 1 014980142

1498/40A

Chargeur démarreur multifonction 12-24V

Ne disposant pas de batterie interne, la fonction de démarrage (max. 350A) ne remplace pas celle d'un booster de démarrage spécifique type 1498LT/12 (2000A).



- 3 cycles de charge programmés et 1 cycle manuel
- potentiomètre de réglage électronique
- processus spécifiques de charge WET-SPIRAL/GEL-AGM
- système de contrôle et de protection électronique
- processus de charge à 10 phases
- fonction désulfuration et récupération batterie
- fonction supply
- double tension 12-24V
- également indiqué pour batteries Start&Stop
- pinces professionnelles en cuivre isolées en caoutchouc

DONNÉES TECHNIQUES

Alimentation : 230V
 Tension en sortie : 12-24V
 Courant de charge : 1-40A
 Courant de mise en marche : 350A max cc
 Capacité de charge : 4-450Ah

1498/40A CHF 1,535.00 1 014980140
 330x250x792

1498SM

Appareil de sauvegarde de mémoire 12 V

Évite la perte des données mémorisées par l'ordinateur de bord des véhicules automobiles lors des opérations de maintenance ou de remplacement de la batterie.



Caractéristiques techniques :

- auto-alimenté
- batterie interne Pb 5 Ah
- 12 Volts
- connexion professionnelle avec prise OBD

1498SM CHF 326.00 1 014980020

1498SM-C

Câble mémoire auto OBD II 12V pour 1498SM/C



1498SM-C CHF 36.00 1 014980021

1498SM-CP

Câble mémoire auto pince 12V 1498SM/CP



1498SM-CP CHF 33.00 1 014980022

1498SM-A

Alimentateur de sauvegarde de mémoire 1498SM/A



1498SM-A CHF 36.50 1 014980023

1498TB/6-12

Testeur de batterie analogique 6-12 V

Permet l'analyse des batteries 6 V et 12 V jusqu'à 1000 CCA



Longueur des câbles : 500 mm

1498TB/6-12 CHF 75.50 1 014980420
 L 290 mm L1 170 mm P 75 mm



1498TB/12-24

Testeur numérique pour batteries 12V, analyseur du système de démarrage et du circuit de charge en 12-24V

- Permet d'effectuer les tests suivants : batteries, alternateurs, démarreurs, circuits de régulation et contrôles des masses défaillantes
- Equipé d'un logiciel permettant d'imprimer les tests sur PC
- Afficheur rétro-éclairé
- Structure compacte et antichoc
- Logiciel en 10 langues
- Equipé d'un port dédié pour le branchement d'une mini imprimante extractible (accessoire en option Beta 1498ST/TB)



CE

DONNÉES TECHNIQUES :

- Applications : Test batteries 12V - Test alternateur 12-24V charge - Test systèmes de démarrage
- Intervalle de fonctionnement : 100-2000 CCA
- Normes de référence : CCA, SAE, DIN, EN, IEC, JIS
- Batteries supportées : PB, WET, GEL, AGM, AGM FLAT, EFB
- Voltmètre : 9V-36V
- Longueur câbles : 1600 mm
- Langues : Italien, Anglais, Français, Allemand, Espagnol, Polonais, Roumain, Hollandais, Suédois et Finlandais
- Accessoires compris : câble USB et logiciel

1498TB/12-24 CHF 872.00 1 014980401

1498ST/TB

Mini imprimante thermique pour testeur 1498TB/12

- Possibilité de brancher la mini imprimante directement sur le testeur
- Permet d'imprimer les résultats du test effectué



CE

1498ST/TB CHF 312.00 1 014980410

1498ST/TB ROT

Recharge papier pour imprimantes 1498ST/TB



1498ST/TB ROT CHF 15.10 2 014980411

1498PC

Stabilisateur de tension 12-24 V

Indispensable pour protéger les centrales en phase de soudure et mises en marche avec booster



1498PC CHF 130.00 1 014980801

1498TC

Testeur numérique pour bougies

- Permet un test précis et rapide des bougies de préchauffage
- Approprié à tous les types de bougies 4,4-5-7-8,5-10-11 Volts
- Écran d'affichage digital illuminé sur le fond
- Approprié aux bougies en acier et en céramique
- Protection contre le court-circuit et l'inversion de polarité
- Arrêt automatique en cas d'inutilisation
- Muni de l'avertisseur acoustique
- Muni de torche à led SMD
- Structure compacte et antichoc



CE

- Gamme de taille : 0.00÷25.0Ω
- Tolérance : ± 2 %
- Résolution : 0.01
- LED écran d'affichage : 1.8"
- Température de fonctionnement : 0 °C÷50 °C
- Alimentation : 1 pile de 9V (non fournie)

1498TC CHF 264.00 1 014980450

1499

Autoscope



1499 CHF 131.00 1 014990001

1500/...

Extracteur à 2 griffes coulissantes

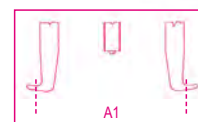
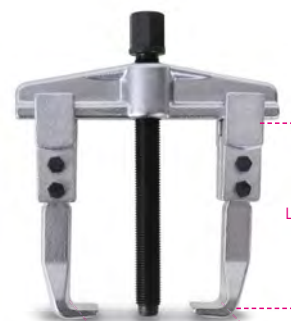

	L mm	CHF		
1500/1	100	109.00	1	015000301
1500/2	100	114.00	1	015000302
1500/3	150	189.50	1	015000303
1500/4	150	261.00	1	015000304
1500/5	205	474.00	1	015000305
1500/6	205	556.00	1	015000306
1500/7	205	832.00	1	015000307
1500/8	230	1,330.00	1	015000308

	A min÷Max mm	A1 min÷Max mm
1500/1	25÷80	70÷130
1500/2	25÷130	80÷180
1500/3	50÷160	105÷220
1500/4	60÷200	120÷270
1500/5	80÷250	160÷330
1500/6	80÷350	160÷420
1500/7	110÷520	195÷600
1500/8	170÷640	260÷715



1500/SP5 CHF 1,225.00 1 015000325
1500/1-1500/2-1500/3
1500/4-1500/5
1500/SPV 106.50 1 015000001

1500G/...

Paire de griffes série normale pour 1500 et 1580/8I



	±0.1 mm	1500 mm	CHF		
1500G/1	35	/1-2	70.00	1	015000311
1500G/3	35	/3-4	103.50	1	015000313
1500G/5	35	/5-6-7	211.00	1	015000315
1500G/8	50	/8	259.00	1	015000317
		1580/8I			

1500N/...

Extracteur universel à 2 griffes coulissantes

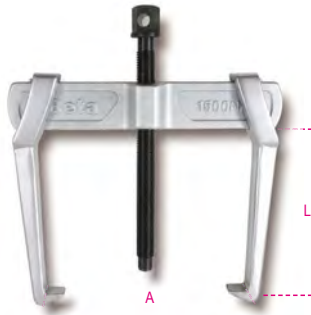

	A min+Max mm	L mm	CHF		
1500N0	18÷65	70	98.00	1	015000600
1500N1	23÷70	100	102.50	1	015000601
1500N2	23÷100	100	110.50	1	015000602
1500N3	35÷140	150	184.00	1	015000603
1500N4	35÷190	150	197.50	1	015000604
1500N5	43÷250	205	381.00	1	015000605
1500N6	43÷320	205	413.00	1	015000606



	CHF		
1500N/SP6	1,073.00	1	015000626
1500N/0-1500N/1-1500N/2-1500N/3			
1500N/4-1500N/5			
1500N/SPV	129.50	1	015000006

1500N/G...

Griffe pour 1500N



	± 0.1 mm	fit 1500N /0	CHF		
1500N/G0	10	/0	32.00	2	015000650
1500N/G1-2	12	/1-2	34.00	2	015000651
1500N/G3-4	17	/3-4	60.50	2	015000653
1500N/G5-6	23	/5-6	119.00	2	015000655

1501/1 - 2 - 3

Extracteur à 2 griffes fines coulissantes

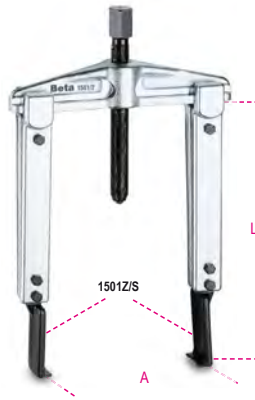

	L mm	CHF		
1501/1	100	246.00	1	015010101
1501/2	200	261.00	1	015010102
1501/3	250	274.00	1	015010103

	A min+Max mm	CHF		
1501/1	25÷130			
1501/2	25÷130			
1501/3	25÷130			

1501G/1 - 2 - 3

Griffe pour 1501



	L mm	CHF		
1501G/1	100	135.50	1	015010111
1501G/2	200	157.50	1	015010112
1501G/3	250	171.00	1	015010113

1501Z/S - P - R

Embout pour griffe 1501G



	± 0.1 mm	D mm	CHF		
1501Z/S	2.0	27	48.50	2	015010211
1501Z/P	3.6	27	49.50	2	015010212
1501Z/R	3.6	14	56.00	2	015010213

1502/...

Extracteurs universels à deux griffes équipés d'un système de verrouillage rapide

Spécifications:

- Pour usage interne et externe
- Les pieds peuvent être déplacés le long de la traverse
- Les pieds sont verrouillés au moyen d'un mécanisme permettant le déverrouillage rapide

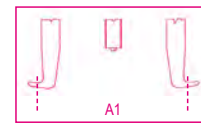
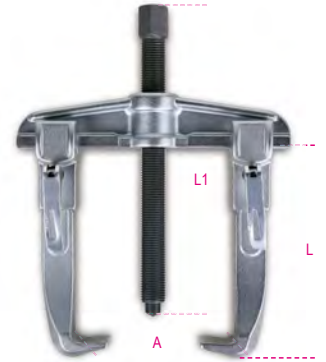

	L mm	L1 mm	CHF		
1502/0	100	166	162.00	1	015020000
1502/1	100	166	176.00	1	015020001
1502/2	150	247	279.00	1	015020002
1502/3	150	247	309.00	1	015020003
1502/4	200	321	531.00	1	015020004

	A min+Max mm	A1 min+Max mm
1502/0	40÷90	80÷130
1502/1	50÷130	90÷170
1502/2	65÷150	115÷210
1502/3	65÷190	125÷260
1502/4	70÷235	170÷335

1505V

Extracteur de bras d'essuie-glace et essuie-glace arrière

Embout en cuivre foré extractible pour extraction de bras avec buse lave-vitre intégrée



	A Max mm	L mm	CHF		
1505V	43	37	57.00	1	015050001

1505/C5

Kit pour extraction essuie-glace

1 extracteur à 2 griffes Ø 25+40 mm
4 demi-lunes Ø 25 mm, Ø 30 mm, Ø 35 mm, Ø 41 mm



mm	CHF		
12	191.00	1	015050300

320x150x60 mm - 1,2 kg

1506

Extracteur auto-serrant à 2 griffes

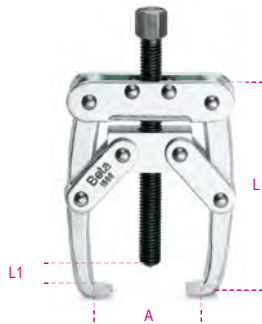

A	L	L1	CHF		
min=Max	mm	mm			
10÷50	80	40	59.00	1	015060001

1508/1 - 1508/2

Extracteur à 2 griffes larges

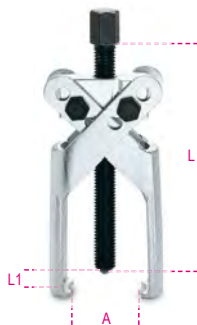

L	CHF		
mm			
1508/1 105	196.00	1	015080001
1508/2 130	233.00	1	015080002

A	L1
min=Max	mm
1508/1 6÷100	85
1508/2 10÷140	120



1511/1 - 2 - 3

Extracteur à 2 griffes réversibles à prise extérieure

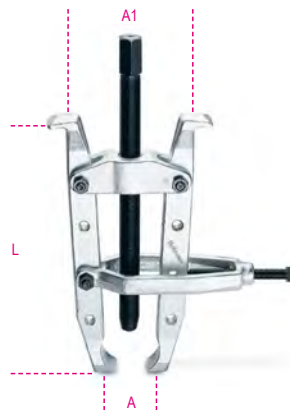

L	CHF		
mm			
1511/1 235	332.00	1	015110001
1511/2 330	415.00	1	015110002
1511/3 405	516.00	1	015110003

A	A1
min=Max	min=Max
mm	mm
1511/1 20÷100	65÷95
1511/2 40÷150	103÷190
1511/3 40÷150	103÷175

1515/1 - 2 - 3

Extracteur à 2 griffes articulées



L	CHF		
mm			
1515/1 85	43.50	1	015150101
1515/2 85	46.00	1	015150102
1515/3 105	69.00	1	015150103

A	L1
Max	mm
1515/1 60	105
1515/2 70	105
1515/3 90	105

1516/1 - 2 - 3

Extracteur à 3 griffes articulées



L	CHF		
mm			
1516/1 85	62.50	1	015160001
1516/2 85	67.00	1	015160002
1516/3 105	95.50	1	015160003

A	L1
Max	mm
1516/1 60	85
1516/2 70	85
1516/3 90	105

1517

Extracteur auto-serrant à 3 griffes

- Pour charges d'extraction élevées.
- Effet autoserrant.

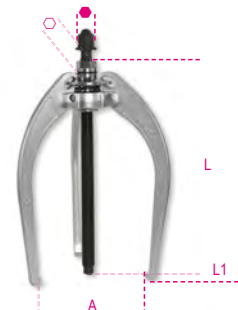

L	L1	Ø	CHF		
mm	mm	mm			
1517/90 182	60	22	341.00	1	015170000
1517/150 242	115	22	350.00	1	015170010
1517/200 307	150	22	403.00	1	015170020
1517/260 395	180	30	467.00	1	015170030

●	A	kg	N
mm	mm		
1517/90 19	18÷90	6000	59000
1517/150 19	25÷150	6000	59000
1517/200 19	40÷200	6000	59000
1517/260 27	50÷260	8000	78500



1517C EXTRACTEUR AUTO-SERRANT À 3 GRIFFES

L'extracteur Beta 1517C fonctionne avec serrage automatique des griffes grâce au ressort sur la traverse.

Cette caractéristique facilite le positionnement et le verrouillage de l'extracteur sur la pièce à extraire. Une fois positionnées, les griffes peuvent être verrouillées à l'aide de la bague.

La traverse particulière du 1517C dispose de 4 emplacements permettant d'utiliser l'extracteur soit avec 2 griffes, pour un travail plus facile et plus rapide, soit avec 3 griffes pour une plus grande stabilité de travail.

La goupille de sécurité positionnée en tête de vis casse lorsque le couple maximum autorisé est dépassé, protégeant ainsi l'extracteur des surcharges.



1517C/...

extracteurs autobloquants combinés à deux / trois griffes

- pour une utilisation avec 2 ou 3 griffes
- effet autobloquant



	L mm	L1 mm	CHF		
1517C0	145	250	288.00	1	015170500
1517C1	200	300	355.00	1	015170501
1517C2	270	300	440.00	1	015170502

	A mm	● mm
1517C0	12÷140	18
1517C1	20÷180	18
1517C2	30÷280	18

1518/...

Extracteur à 3 griffes articulées
«grande capacité»



	L mm	CHF		
1518/1	105	105.50	1	015180001
1518/2	135	135.00	1	015180002
1518/3	235	238.50	1	015180003
1518/4	270	356.00	1	015180004
1518/5	270	418.00	1	015180005
1518/6	270	438.00	1	015180006

	A min÷Max mm	L1 mm
1518/1	24÷100	105
1518/2	32÷160	150
1518/3	40÷220	220
1518/4	80÷250	240
1518/5	80÷300	350
1518/6	80÷350	400

1518U/...

extracteurs universels à trois griffes

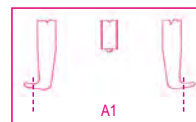
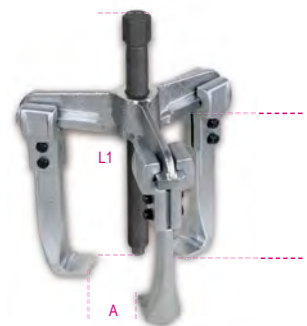

	L mm	L1 mm	CHF		
1518U/0	100	166	199.00	1	015180500
1518U/1	100	166	213.00	1	015180501
1518U/2	150	247	324.00	1	015180502
1518U/3	150	247	339.00	1	015180503
1518U/4	200	321	489.00	1	015180504

	A min÷Max mm	A1 min÷Max mm	● mm
1518U/0	40÷90	80÷130	17
1518U/1	50÷130	90÷170	17
1518U/2	65÷150	115÷210	22
1518U/3	65÷190	125÷260	22
1518U/4	70÷235	170÷335	27

1519/...

Extracteurs universels à trois pieds
avec système de verrouillage rapides des griffes

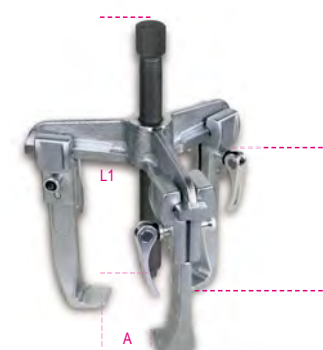

	L mm	L1 mm	CHF		
1519/0	100	166	229.50	1	015190000
1519/1	100	166	243.50	1	015190001
1519/2	150	247	348.00	1	015190002
1519/3	150	247	370.00	1	015190003

	A min÷Max mm	A1 min÷Max mm	● mm
1519/0	40÷90	80÷130	17
1519/1	50÷130	90÷170	17
1519/2	65÷150	115÷210	22
1519/3	65÷190	125÷260	22

1520/1 - 1520/2

Extracteur à 2 griffes réversibles



	L mm	CHF		
1520/1	135	100.50	1	015200101
1520/2	235	171.00	1	015200102

	A Max mm	L1 mm
1520/1	110	85
1520/2	160	140

1521/1 - 1521/2

Extracteur à 3 griffes réversibles



	L mm	CHF		
1521/1	135	129.50	1	015210101
1521/2	235	227.50	1	015210102

	A Max mm	L1 mm
1521/1	110	90
1521/2	160	140

1528

Extracteur autoserrant pour disques frein



19 mm

	A min+Max mm	CHF		
	170÷380	230.50	1	015280000

260x240x60 mm - 4,8 kg

1529

Extracteur pour poulies à gorges multiples



	A min+Max mm	L min+Max mm	L1 min+Max mm	CHF		
	24÷240	60÷95	90÷135	339.00	1	015290000

260x210x60 mm - 2,6 kg

1529/C7

Extracteur pour poulies

Comprises dans le kit :

- 2 griffes avec double pied épaisseur 4,7 mm
- 2 griffes à pied unique épaisseur 4,3 mm
- 1 griffe avec double pied épaisseur 2,3 mm
- 1 griffe à pied unique épaisseur 2,3 mm

Le couple de griffes est modulaire en fonction de l'exigence opérationnelle



	L mm	L1 mm	A min+Max mm	CHF		
1529/C7	50	72,5	53÷114	197.00	1	015290100

285x155x50 mm - 2 kg

1529PI

Extracteur universel pour poulie pompe à injection

- Permet un démontage rapide et précis de la poulie pompe à injection carburant.
- Particulièrement indiqué pour Fiat, Ford, Volkswagen, Citroën et Peugeot

Comprend 3 vis pour serrer l'extracteur à la poulie :

M6 x 1,0 x 49 mm

M7 x 1,0 x 75 mm

M8 x 1,25 x 76 mm



	A min+Max mm	CHF		
1529PI	170÷380	141.50	1	015290051

1529/PG

Extracteur pour pompe haute pression gasoil automobiles groupe VAG

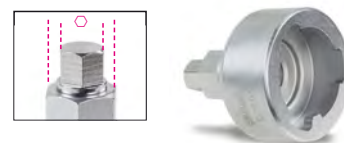

	mm	CHF		
	15-24	87.00	1	015290010

1530/C5

Kit d'extraction de moyeux et roulements de roues à 3, 4, 5 trous

Le kit comprend :

1 bride universelle 96÷138 mm

1 vis hydraulique de 12 tonnes

1 masse battante de 2,8 kg indispensable pour les moyeux sans boulon de fixation central



	mm	CHF		
1530/C5	760x320x120	712.00	1	015300300

760x320x120 mm - 11,5 kg

1530/C16

Kit extracteur à inertie avec petites colonnes d'écartement, pour l'extraction des moyeux et roulements de roues à 3, 4 et 5 trous

Idéal pour moyeux avec anneau de centrage saillant

Compris dans le kit :

• 1 bride universelle 90÷130 mm

• 1 masse battante de 5 kg

• 4 petites colonnes coupleur M12

• 4 petites colonnes coupleur M14



	mm	CHF		
1530/C16	760x310x100	875.00	1	015300316

760x310x100 mm - 13,5 kg

1531/C7

Kit extracteur pour bagues intérieures de roulement de roue

tailles incluses:

- 1 pince Ø 40 ÷ 45 mm
- 1 pince Ø 45 ÷ 51 mm
- 1 pince Ø 50 ÷ 55 mm
- 1 pince Ø 55 ÷ 61 mm



1531/C7 CHF 962.00 1 015310107

390x315x96 mm - 4,3 kg

1532

Outil pour extraire les joints et des déflecteurs d'huile



1532 CHF 22.30 2 015320001

1533/...

Potence pour 1534



	L mm	CHF		
1533/2	150	145.00	1	015330002
1533/3	210	277.00	1	015330003
1533/4	315	439.00	1	015330004
1533/5A	305	531.00	1	015330006

	A min=Max mm	L1 mm
1533/2	45÷140	110
1533/3	55÷205	175
1533/4	90÷260	175
1533/5A	100÷360	235

1533PR/1 - 2 - 3

Rallonge pour 1533



	CHF		
1533PR/1	31.50	1	015330011
1533/2			
1533PR/2	34.00	1	015330012
1533/3			
1533PR/3	36.00	1	015330013
1533/4-5			
1533PR/5A	36.00	1	015330016
1533/5A			

1534/...

Décolleur

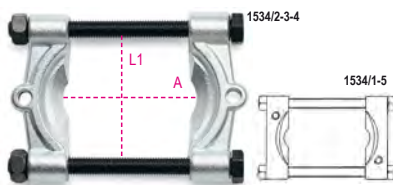

		CHF		
1534/1	1533/2	126.50	1	015340001
1534/2	1533/2	149.50	1	015340002
1534/3	1533/3	248.50	1	015340003
1534/4	1533/4	418.00	1	015340004
1534/5A	1533/5A	861.00	1	015340006

	A min=Max mm	L1 mm
1534/1	5÷60	63
1534/2	12÷75	75
1534/3	22÷115	118
1534/4	25÷155	154
1534/5A	30÷220	180

1535/C...

Composition d'extracteurs



	CHF		
1535/C1	407.00	1	015350001

260x180x40 mm - 2,5 kg

	CHF		
1535/C2	429.00	1	015350002

	1533/2
	1533PR/1
	1534/1

260x180x40 mm - 2,8 kg

	CHF		
1535/C3	697.00	1	015350003

	1533/3
	1533PR/2
	1534/3

380x280x55 mm - 8,0 kg

	CHF		
1535/C4	1,080.00	1	015350004

	1533/4
	1533PR/3
	1534/4

420x380x65 mm - 14,8 kg

	CHF		
1535/C5A	1,650.00	1	015350006

	1533/5
	1533PR/3
	1534/5

530x510x85 mm - 27,2 kg

1539

Tire-tôles à inertie



1539 CHF 221.50 1 015390001

1540

Masse à inertie

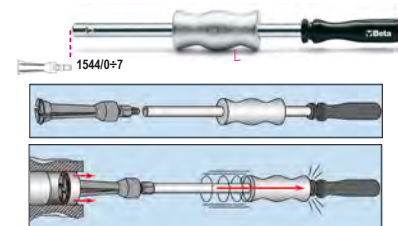

1540 CHF 124.00 1 015400001

L mm 390 M10 1544 0÷7





1542/1 - 1542/2

Extracteur pour griffes



	A	min+Max	1544	CHF		
	mm	mm				
1542/1	35÷75	0÷7		106.50	1	015420001
1542/2	60÷130	9C-10C		160.50	1	015420002

	L	L1
	mm	mm
1542/1	140	140
1542/2	175	160

1544/...

Extracteur à pince à prise intérieure

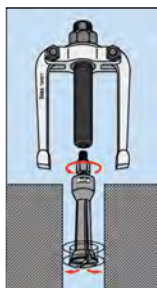

	C	mm	CHF		
1544/0	0,25	M10	94.00	1	015440100
A= 5÷7					
1544/A	0,80	M10	98.00	1	015440105
A= 7÷9					
1544/1	0,80	M10	100.50	1	015440110
A= 9÷12					
1544/2	1,15	M10	103.00	1	015440120
A= 13÷17					
1544/2B	1,00	M10	104.50	1	015440121
A= 14÷19					
1544/3	1,70	M10	108.00	1	015440130
A= 16÷21					
1544/4	1,65	M10	119.50	1	015440140
A= 20÷25					
1544/5	2,00	M10	128.50	1	015440150
A= 25÷30					
1544/6	3,00	M10	160.50	1	015440160
A= 30÷37					
1544/7	3,80	M10	182.00	1	015440170
A= 38÷45					
1544/9C	2,60	G 3/8"	264.00	1	015440189
A= 40÷75					
1544/10C	7,30	G 3/8"	365.00	1	015440199
A= 70÷115					

1545/C5M

Coffret d'extracteur 1542/I
avec 5 extracteurs à pinces 1544



1545/C5M	CHF		
	715.00	1	015450011

1542/1	● 24 mm
1544/1	9÷12 mm
1544/2	13÷17 mm
1544/3	16÷21 mm
1544/4	20÷25 mm
1544/5	25÷30 mm

265x180x45 mm - 2,4 kg

1547/C6

Extracteurs pour roulements
à fausses billes
en coffret métallique



1547/C6	CHF		
	373.00	1	015470006

420x185x60 mm - 3 kg

1547KP

Jeu de 3 paires d'extracteurs pour roulements
à billes



	Ø	mm	CHF		
1547KP/1	9-11-12,5		58.00	1	015470106
1547KP/2	5-6-8		40.50	1	015470206

1547P

Rallonge 6 pans



	L	mm	CHF		
1547P/1	205	1547/1	12.50	1	015470101
1547P/2	102	1547/2	8.00	1	015470201

1547PC/2

Rallonge ronde courte



	L	mm	CHF		
1547PC/2	42	1547/2	6.45	1	015470203

1547PL/2

Rallonge ronde longue



	L	mm	CHF		
1547PL/2	106	1547/2	7.20	1	015470203

1549

Kit pour démontage et montage amortisseurs
à double effet avec retour pneumatique

Permet de maintenir la tige en extension pendant le montage
des ressorts



1549	CHF		
	507.00	1	015490001

310x270x110 mm - 3 kg



1550U

Compresseurs de ressort pneumatique pour automobiles, SUV et véhicules commerciaux

CE

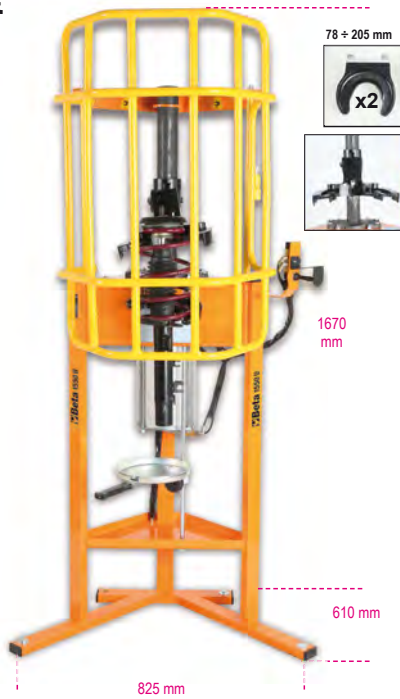

PUISSANCE PLUS ÉLEVÉE : puissance poussée maximum 2 tonnes (10 bars).
SYSTÈME UNIVERSEL DE PRISE SUPÉRIEURE : permet avec une plaque unique adaptable supérieure de comprimer tous les diamètres de ressort pour serrage et desserrage.
SYSTÈME DE SÉCURITÉ ACTIVE SUR LE RESSORT : par le biais du crochet de sécurité et des 3 soupapes de blocage, le positionnement/logement correct du ressort est garanti en maintenant cette position pendant toute l'opération de compression.

En cas de positionnement "non conforme" du ressort, le système arrête la machine.

GRILLE DE PROTECTION "FULL BODY" : garantit la plus haute sécurité et couverture de la zone de travail.

ACTIONNEMENT AVEC LEVIER DE COMMANDE : plus grande précision et sensibilité lors de la phase de compression.

POSITION DE TRAVAIL : hauteur de travail sur l'étrier arrière élevé jusqu'à 875 mm.

Fourni avec 2 étriers inférieurs pour diamètres 78-205 mm

DONNÉES TECHNIQUES :

Puissance poussée : 2 tonnes (10 bars) - 1,6 tonnes (8 bars) - 1,2 tonnes (6 bars)

Course de compression ressort : 335 mm

1550U CHF 3,860.00 1 015500010

1550U/CGS-R

Couple d'étriers supérieurs abaissés pour 1550U



1550U CGS-R CHF 743.00 1 015500035

1550U/MRC-ABE

Étriers spéciaux pour 1550U pour Mercedes Classe A-B-E



1550U/MRC-ABE CHF 766.00 1 015500031

1550U/MRC-C

Étriers spéciaux pour 1550U pour Mercedes Classe C



1550U/MRC-C CHF 673.00 1 015500032

1550U/S...

Étrier inférieur pour 1550U



	Ø mm	CHF		
1550U/S 130	78±130 mm	487.00	1	015500014
1550U/S 182	105±182 mm	487.00	1	015500015
1550U/S 205	125±205 mm	487.00	1	015500016

1550U/SS187

Coupelle de desserrage pour 1550U

Particulièrement indiquée pour les ressorts avec profil gauche type Nissan Qashqai et Renault Koleos



1550U/SS 187 CHF 487.00 1 015500018

1550U/M

Étau pour démontage amortisseurs 1550U

Permet de bloquer la tige de l'amortisseur



1550U/M CHF 463.00 1 015500021

1551/C20

Kit pour démontage têtes amortisseurs

Compris dans le kit :

- 7 douilles 6 pans mesures : 16 - 17 - 18 - 19 - 21 - 22 - 24
- 1 rallonge porte-douille longueur 120 mm
- 3 embouts femelle mesures : 8x5 - 8x6 - 11x8
- 1 embout femelle pour vis 6 pans creux mesure : 10 mm
- 1 embout mâle XZN(R) mesure : M10
- 1 embout mâle Torx(R) mesure : T50
- 4 embouts mâle pour vis 6 pans mesures : 5 - 6 - 7 - 8
- 1 rallonge porte-embouts longueur 95 mm
- 1 rallonge porte-embouts longueur 190 mm



Ø 8 - 21 mm

1551/C20 CHF 204.00 1 015510020

320x245x71 mm - 2,6 kg

1552/C9

Kit pour écarter les joints des amortisseurs, bras oscillants et volant

Il est possible de travailler avec tête à simple ou double écarteur, de sorte à pouvoir intervenir également sur les joints doubles type groupe VAG.



Ø 13 mm

1552/C9 CHF 162.00 1 015520020

195x140x40 mm - 1,0 kg



1555/Q

Compresseur pour ressorts d'amortisseurs MacPherson ou équivalents

Poussée maximum : 1500 kg



A	Ø	CHF		
min+Max	min+Max			
65+354	80÷195	1,055.00	1	015550006

1555/QS

Compresseur pour ressorts d'amortisseurs MacPherson ou équivalents



A	Ø	CHF		
min+Max	min+Max			
70+300	80÷200	1,300.00	1	015550005

1555S/BMW-RNT

Coupe pour amortisseurs BMW E39, E46 et Renault Mégane II pour 1555Q et 1555/QS



1555S/BMW-RNT	CHF			
	408.00	1	015550303	

1555C

Compresseur des ressorts télescopique avec 2 jeux de coupelles et barre de torsion



A	Ø	N	t	CHF		
min+Max	min+Max					
80+225	90+160	25000	8,5	1,250.00	1	015550202

1556/1A

Compresseur de ressorts

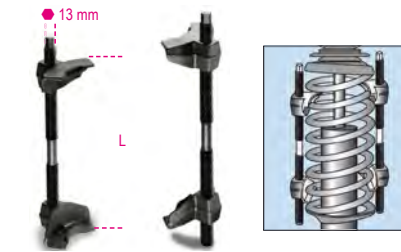

min L	Max	CHF		
mm	mm			
65+320		304.00	1	015560101

1556/2A

Compresseur de ressorts

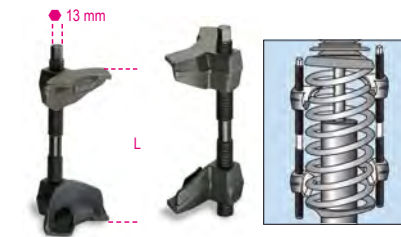

min L	Max	CHF		
mm	mm			
65+200		301.00	1	015560102

1557

Douilles à chocs pour axes de ressort à lames Truck



L	L1	CHF		
mm	mm			
37	28	113.00	1	015570137
46	34	115.50	1	015570146
56	34	125.00	1	015570156

1557V

Douille à chocs pour axes de ressort à lames Truck Volvo



mm	CHF		
27	59.00	1	015570299

1557/S3

Jeu de 3 clés à ergots pour écrous de tige d'amortisseur

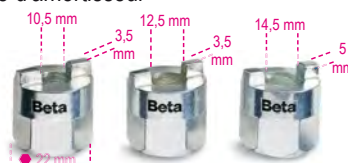

1557/S3	CHF		
	88.00	1	015570010

1558/C4

Outil pour circlips de moyeux intérieurs et extérieurs avec actionnement à vis

Le coupleur carré 3/8" permet d'appliquer une force élevée dans les deux conditions d'utilisation

Ergots fournis : Ø 2,5-3-3,5 mm



1558/C4	CHF		
5,5 ÷ 77	217.50	1	015580100
330x220x50 mm - 900 g			

1558P

Couple ergots circlips de moyeux pour 1558



Ø	CHF		
mm			
2,5	9.50	1	015580125
3,0	9.50	1	015580130
3,5	9.50	1	015580135

1558/C13

Outil pour circlips de moyeux intérieurs et extérieurs avec actionnement à vis

Le coupleur carré 3/8" permet d'appliquer une force élevée dans les deux conditions d'utilisation

Ergots fournis :
 • droits : Ø 2,5 - 3 - 3,5 - 3,8 mm
 • 45° : Ø 2,5 - 3 - 3,5 - 3,8 mm
 • 90° : Ø 2,5 - 3 - 3,5 - 3,8 mm



1558/C13	CHF		
5,5 ÷ 77	291.00	1	015580200
330x220x45 mm - 1,6 kg			

1559

Extracteur de rotules, type léger



	A Max mm	Ø mm	CHF		
1559/22	50	18÷22	112.00	1	015590001
1559/36	90	36	517.00	1	015590036
1559/45	115	45	775.00	1	015590045

1559V/8T

Vis hydraulique pour extracteur de rotules
1559/36 et 1559/45

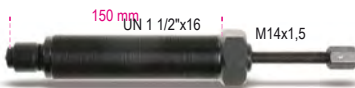

Nm	t	CHF		
80000	8	391.00	1	015590145

1560/2

Extracteur de rotules,
modèle professionnel



	A min÷Max mm	Ø mm	CHF		
1560/2	60÷85	20	240.50	1	015600002

1560A

Extracteur de rotules



	CHF		
1560A	322.00	1	015600601

1561/...

Chasse-rotules



	L mm	A mm	Ø mm	CHF		
1561/1	39	36,6	18	87.50	1	015610001
1561/2	47	45,7	25	114.00	1	015610002
1561/3	63	62	30	166.00	1	015610003
1561/4	75	63	40	211.00	1	015610004

1562D

Extracteur de rotules

Fourni avec 2 vis pour l'extraction de joints à rotule de suspension et de direction



A max mm	Ø mm	● mm	L mm	CHF		
50	39	26	155	439.00	1	015620239

1563/C4

Jeu de 4 douilles pour le démontage des rotules

A utiliser avec un marteau pneumatique
définir le contenu:

- 1 douille M12x1,25 mm
- 1 douille M12x1,5 mm
- 1 douille M14x1,5 mm
- 1 douille M16x1,5 mm



	CHF		
1563/C4	62.50	1	015630010

1565/1 - 2 - 3

Chasse-rotules à frapper



	Ø mm	L1 mm	CHF		
1565/1	18	65	100.00	1	015650001
1565/2	23	65	112.00	1	015650002
1565/3	30	88	117.00	1	015650003

1566N

Extracteur de rotules axiales de direction



Ø x L mm	Ø mm	CHF		
28÷35 x 400	27	158.50	1	015660005
35÷45 x 190	27	158.50	1	015660008
35÷45 x 400	27	178.50	1	015660010

1566R

Extracteur de rotules axiales de direction



Ø mm	CHF		
27÷43	30.50	1	015660015

1566/G01

Extracteur pour joints homocinétiques

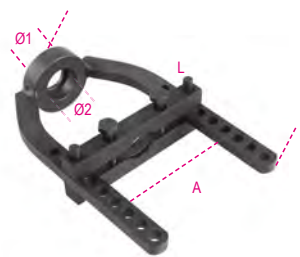

	L mm	A mm	Ø1 mm	Ø2 mm	CHF		
1566/G01	250	115	29	36	189.00	1	015660052

1566P

Pince pour circlips
antidérapant pour arbres de roue

La pince comprime le circlip et simplifie ainsi l'insertion de l'arbre de roue dans le joint homocinétique.



	L mm	A Max mm	CHF		
1566P	280	36	86.00	1	015660091

1567

Levier dépose brides d'amortisseur

Utilisable par un seul opérateur



	A mm	B min÷Max mm	CHF		
1567	1060	100÷300	435.00	1	015670001

1568

Expandeur pneumatique pour le montage des soufflets de cardan
8 bras d'écartement
écartement maximal des bras: 145 mm

CE



L mm	L1 mm	CHF		
420	195	310.00	1	015680001

1569/F

Composition d'outils pour le montage et le démontage des silentblocks avant et arrières des Fiat Panda, Fiat 500 et Ford Ka



1569/F	CHF		
	573.00	1	015690021

1569/SB

Composition d'outils pour l'extraction et l'introduction des silentbloks pont arrière, déflecteurs d'huile arbre moteur et roulements de roue

• Les douilles peuvent être utilisées aussi bien directement sur le véhicule qu'à la presse hydraulique



1569/SB	CHF		
	321.00	1	015690016

425x365x100 mm - 13 kg

1569CP

Injecteur à percussion pour roulements coniques et déflecteurs d'huile
Réglage rapide



	Ø min+Max mm	L mm	CHF		
1569CP/50	9,5÷50	130	170.00	1	015690750
1569CP/90	18÷90	145	211.00	1	015690790

1570/3

Vérin hydraulique pour extracteurs



t	L mm	L1 mm	• mm	CHF		
30	243	36	19	312.00	1	015700003

1580/8I

Extracteur hydraulique 2 griffes

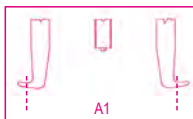
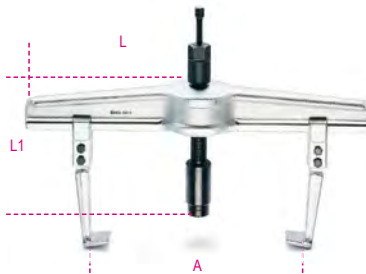

1580/8I	CHF		
	2,000.00	1	015800008

	A min+Max mm	L mm	L1 mm	A1 min+Max mm	N Max
1580/8I	170÷640	715	280	260÷715	180000

1580GL

Griffe longue pour extracteurs 1580/8I



	L mm	CHF		
1580GL/8A	300	226.50	1	015800227
1580GL/8B	400	252.00	1	015800228
1580GL/8C	500	321.00	1	015800229

1585/5I - 6I - 7I

Extracteur hydraulique 3 griffes

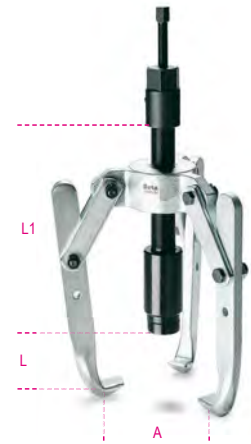

	CHF		
1585/5I	1,390.00	1	015850005
1585/6I	1,465.00	1	015850006
1585/7I	1,505.00	1	015850007

	A min+Max mm	L1 mm	L mm	N Max
1585/5I	50÷350	135	280	150000
1585/6I	50÷350	235	280	150000
1585/7I	50÷350	335	280	150000

1585GI/5 - 6 - 7

Griffe pour 1585/I-1585/6I-1585/7I

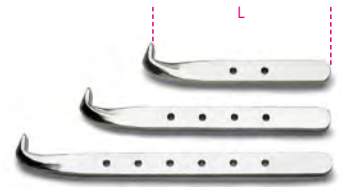

	L mm	CHF		
1585GI/5	135	126.50	1	015850205
1585GI/6	235	149.50	1	015850206
1585GI/7	335	181.50	1	015850207

1589VI

Vis hydraulique pour 1580/8I et 1585/5I-1585/6I-1585/7I



1589VI	CHF		
	821.00	1	015890001

1589PI/50 - 100 - 150

Rallonge pour vis hydraulique



	L mm	L1 mm	CHF		
1589PI/50	50	70	74.50	1	015890005
1589PI/100	100	120	82.00	1	015890010
1589PI/150	150	170	89.00	1	015890015

1590

Presse d'assemblage



A max mm	L1 mm	CHF		
60	55	34.00	2	015900305
100	65	54.50	2	015900310
150	95	90.50	2	015900315

1591

Presse à vis



A mm	A max mm	L1 mm	CHF		
200	200	80	36.00	2	015910020
300	310	85	44.00	2	015910030
400	410	85	47.00	2	015910040
500	500	95	64.00	2	015910050
600	600	95	65.00	2	015910060
800	800	95	78.50	2	015910080
1000	1000	110	99.00	2	015910100

1593

Serre-joints à vis avec poignée

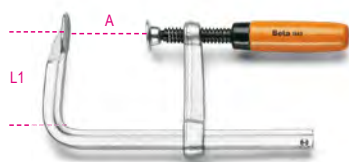

A mm	A max mm	L1 mm	CHF		
160	170	80	42.50	2	015930016
200	240	100	65.00	2	015930020
300	320	145	91.00	2	015930030

1594

Serre-joints à levier



A mm	A max mm	L1 mm	CHF		
200	240	145	141.50	1	015940020
250	290	145	147.00	1	015940025
300	340	145	157.50	1	015940030
400	430	150	165.00	1	015940040
500	530	150	173.00	1	015940050
600	630	150	181.50	1	015940060

1595

Serre-joints à vis zingué

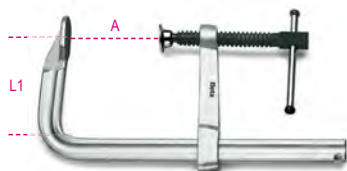

A mm	A max mm	L1 mm	CHF		
200	230	100	67.50	2	015950020
250	270	120	73.50	2	015950025
300	330	120	93.50	2	015950030
400	420	120	105.50	2	015950040
500	520	125	114.00	2	015950050
600	620	125	121.00	2	015950060
800	820	125	143.00	1	015950080
1000	1030	125	159.50	1	015950100

1599F

Étau parallèle d'établi, forgé

Entièrement en fonte d'acier. Mâchoires fraisées et trempées en surface.

Ouverture avant. Grande profondeur de serrage



L1 mm	BxH mm	Ø mm	A MAX mm	CHF		
100	92x46	11	125	419.00	1	015990100
125	108x54	13	150	536.00	1	015990125
150	125x62	13	200	753.00	1	015990150
175	140x70	15	220	1,027.00	1	015990175

1599GI

Étau parallèle d'établi à mâchoires interchangeables

• Avec guide carré pour les travaux difficiles

• Mâchoires interchangeables avec surface trempée

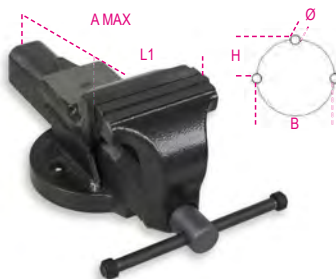

L1 mm	BxH mm	Ø mm	A MAX mm	CHF		
100	92x46	11	125	324.00	1	015990200
125	108x54	13	150	445.00	1	015990225
150	125x62	13	200	608.00	1	015990250
175	140x70	15	220	811.00	1	015990275

1599GR

Paire de mâchoires et vis de rechange pour étau 1599GI



A mm	CHF		
1599GR 100	100	31.00	1 015990920
1599GR 125	125	39.00	1 015990925
1599GR 150	150	47.00	1 015990950
1599GR 175	175	55.00	1 015990975

1599P

Étau parallèle d'établi

Mâchoires trempées
Enclume avec ample surface vernie
Base carrée en acier

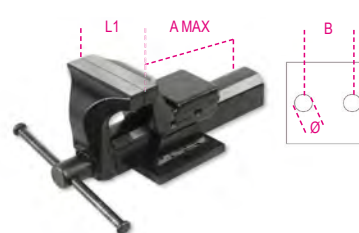

L1 mm	B mm	Ø mm	A MAX mm	CHF		
100	92	11	111	368.00	1	015990000
125	108	13	130	443.00	1	015990025
150	130	15	170	616.00	1	015990050

1599B

Base pivotante pour étau 1599P



1599B	1599P	CHF		
1599B 100	100	153.50	1	015990810
1599B 125	125	175.00	1	015990812
1599B 150	150	216.50	1	015990815

1599T

Étau parallèle de perceuse

Étaux en fonte spéciale, avec mâchoires trempées et rectifiées

Applicable sur les petites et moyennes perceuses à colonne

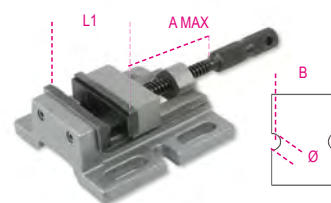

L1 mm	B mm	Ø mm	A MAX mm	CHF		
80	111	11	65	207.50	1	015990480
100	120	13	87	258.00	1	015990500

1599G

Paire de protège-mâchoires en aluminium

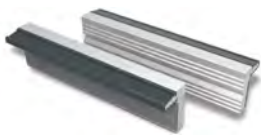

A mm	CHF		
100	67.50	1	015990910
125	70.00	1	015990912
150	77.00	1	015990915
180	85.00	1	015990917

1600Q 8

Clé cruciforme pour tableautiers

Carré de 5 / 6 / 7-8 mm
Triangle de 9 mm
Ailettes de 3-5 mm
Hexagone de 1/4"
Embout double avec fente 1,0x7mm et empreinte cruciforme PH2



L mm	CHF		
76	38.00	1	016000008

1600Q 10

Clé articulée cruciforme double pour tableautiers

Carré de 5 / 6-7 / 8-9 mm
Triangle de 5-6-7 / 8-9 / 10 mm
Ailettes 3-5 mm
Hexagone 1/4"
Carré mâle 1/4"



L mm	CHF		
125	47.50	1	016000010

SERVICE DE CERTIFICATION DES INSTRUMENTS DE MESURES

La certification des instruments de mesure est essentielle dans les secteurs où les domaines d'application requièrent de mesures précises, et non ambiguës. La certification implique la délivrance d'un certificat Accredia :

Sur demande, Beta Utensili S.p.A. fournit le service de certification pour les niveaux, les pieds à coulisse, les comparateurs, les micromètres et les jauges d'épaisseur. Pour bénéficier de ce service, veuillez contacter votre revendeur BETA.



1650

Pied à coulisse précision au 1/10e

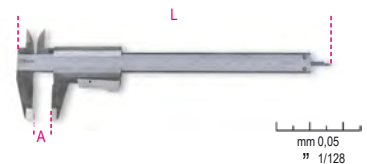

UNI EN ISO 13385-1DIN 862

A max mm	L mm	CHF		
150	235	80.00	1	016500001
200	290	105.50	1	016500002

1650FD

Pied à coulisse pour disque de frein, précision au 1/10e

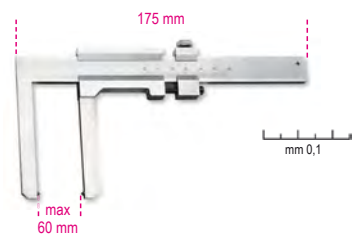

1650FD	CHF		
	280.00	1	016500050

1650FT

Pied à coulisse pour tambour de frein, précision au 1/20e

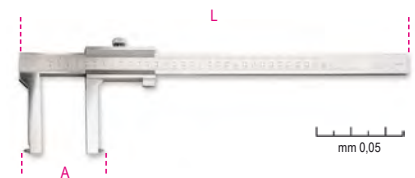

	A max mm	L mm	CHF		
1650FT/1	350	438	525.00	1	016500060
1650FT/2	500	550	915.00	1	016500070

1651DGTB

Pied à coulisse numérique précision au 1/100e

Caractéristiques :

- Précision au 1/100e
- Blocage de la coulisse grâce à une vis
- Conversion mm/pouces
- Mise à zéro dans n'importe quelle position
- Tige de profondeur carrée jusqu'à 300 mm
- Étui rigide de rangement en matière plastique

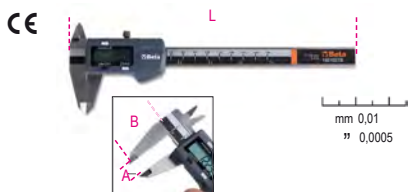

UNI EN ISO 13385-1DIN 862CE

A Max mm	L mm	B mm	CHF		
150	235	40	135.00	1	016510211
200	285	50	176.00	1	016510212
300	400	60	230.00	1	016510213



1651DGTB/IP

Pied à coulisse numérique
précision au 1/100e
avec protection IP67

- Précision au 1/100e
- Blocage à vis de la coulisse
- Conversion mm/pouces
- Allumage automatique grâce au mouvement de la coulisse
- Mise à zéro dans n'importe quelle position
- Fonction HOLD
- Choix possible entre mesure absolue et mesure incrémentale

Le degré de protection IP67 garantit une protection intégrale contre les poussières et les liquides, ce qui préserve les caractéristiques fonctionnelles même en cas d'immersion complète de l'instrument.

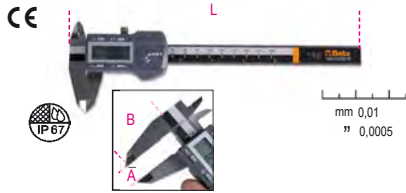

UNI EN ISO 13385-1 DIN 862CE

A Max mm	L mm	B mm	CHF	1	016510711
150	235	40	220.50	1	016510711

270x115x35 mm - 450 g

1652

Pied à coulisse à cadran analogique,
précision au 1/50e



UNI EN ISO 13385-1DIN 862

1652	CHF	1	016520016
	169.00	1	016520016

1654

Pied à coulisse, précision au 1/50e



UNI EN ISO 13385-1DIN 862

A max mm	L mm	CHF	1	016540020
200	330	371.00	1	016540020
300	410	503.00	1	016540030



1654DGT

Pied à coulisse à affichage digital
Précision au 1/100e
Lecture 0,01 mm
Lecture 0,0005"

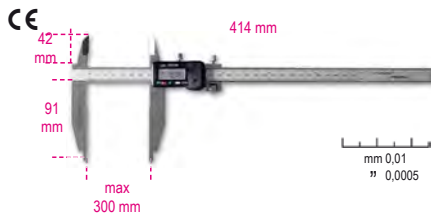

UNI EN ISO 13385-1DIN 862CE

1654DGT	CHF	1	016540111
	849.00	1	016540111

1656

Jauge de profondeur,
précision au 1/50e



UNI EN ISO 13385-2DIN 862

A max mm	L mm	CHF	1	016560020
200	260	176.00	1	016560020
300	360	259.00	1	016560030

1657DGT/2

Jauge de profondeur à affichage digital,
précision au 1/100e

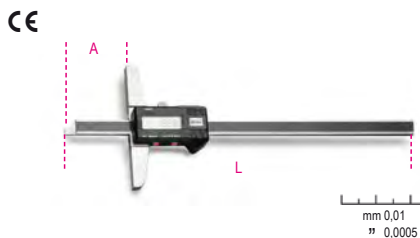

UNI EN ISO 13385-2DIN 862CE

1657DGT/2	A max mm	L mm	CHF	1	016570002
	200	270	327.00	1	016570002

1658/...

Micromètre d'extérieur,
précision au 1/100e



DIN 863/II

	A mm	CHF	1	016580025
1658/25	0÷25	101.00	1	016580025
1658/50	25÷50	109.50	1	016580050
1658/75	50÷75	124.00	1	016580075
1658/100	75÷100	135.50	1	016580100

1658/C4

Coffret de 4 micromètres 1658



DIN 863

1658/C4	CHF	1	016580001
	407.00	1	016580001

1658/25 0÷25 mm

1658/50 25÷50 mm

1658/75 50÷75 mm

1658/100 75÷100 mm

365x245x35 mm - 2,5 kg

1658DGTB

Micromètre d'extérieur numérique IP65
précision au 1/100e

- Précision au 1/1000e
- Contacts en métal dur
- Blocage grâce à un levier de la coulisse
- Conversion mm/pouces
- Mise à zéro dans n'importe quelle position
- Choix possible entre mesure absolue et mesure incrémentale
- Clé de réglage incluse



DIN 863CE

1658DGTB 25	CHF	1	016580525
	276.00	1	016580525
1658DGTB 50	343.00	1	016580550



1658SP/1

Support pour micromètre



1658SP/1	CHF	70.00	1	016580910
----------	-----	-------	---	-----------

1659

Jauge d'épaisseur avec comparateur analogique, précision au 1/100e

C=course



1659	C mm	0÷10	CHF	260.00	1	016590001
------	------	------	-----	--------	---	-----------

1662/1 - 1662/2

Comparateur à cadran analogique, précision au 1/100e

C=course



DIN 878	C mm	0÷5	CHF	119.00	1	016620001
1662/1	C mm	0÷10	CHF	145.00	1	016620010

1662DGT/A

Comparateur à affichage digital précision au 1/100e

C = Course

CE



1662DGT/A	C mm	0-12,5	CHF	361.00	1	016620311
-----------	------	--------	-----	--------	---	-----------

1662AN

Comparateur à cadran analogique à levier précision au 1/100e

C=Course



DIN 2270	C mm	0÷0,8	CHF	281.00	1	016620200
----------	------	-------	-----	--------	---	-----------

1662SP0

Support de comparateur magnétique



1662SP0	CHF	100.50	1	016620800
---------	-----	--------	---	-----------

1662SP2

Support de comparateur articulé magnétique



1662SP2	CHF	181.50	1	016620910
---------	-----	--------	---	-----------

1666

Equerre simple en acier inoxydable, faces rectifiées et polies



DIN 875/0	L mm	L1 mm	CHF			
	100	70	82.00	1	016660210	
	150	100	119.00	1	016660215	
	200	130	142.50	1	016660220	
	250	165	184.50	1	016660225	
	300	200	232.50	1	016660230	

1666A

Equerre à chapeau en acier inoxydable, faces rectifiées et polies



DIN 875/0	L mm	L1 mm	CHF			
	100	70	120.00	1	016660110	
	150	100	163.00	1	016660115	
	200	130	229.50	1	016660120	
	250	170	285.00	1	016660125	
	300	200	361.00	1	016660130	

1668

Equerre simple en acier normalisé faces et arêtes rectifiées



DIN 875/2	L mm	L1 mm	CHF			
	100	70	36.50	2	016680210	
	150	100	48.50	2	016680215	
	200	130	62.50	2	016680220	
	250	165	91.00	1	016680225	
	300	174	112.00	1	016680230	



1668A

Équerre à chapeau en acier normalisé, faces et arêtes rectifiées



DIN 875/2

L mm	L1 mm	CHF		
100	70	43.50	2	016680110
150	100	66.50	2	016680115
200	130	84.50	2	016680120
250	165	121.50	1	016680125
300	176	145.00	1	016680130

1670

Équerre simple, en acier, rectifiée



L mm	L1 mm	CHF		
100	70	22.60	3	016700010
150	100	23.60	3	016700015
200	130	26.50	3	016700020
250	160	29.00	3	016700025
300	175	32.00	3	016700030
400	230	47.50	2	016700040
500	280	53.50	2	016700050
600	330	56.50	2	016700060
800	420	76.00	1	016700080
1000	500	91.00	1	016700099

1670A

Équerre à chapeau, en acier, rectifiée



L mm	L1 mm	CHF		
100	70	29.50	3	016700110
150	100	32.00	3	016700115
200	130	34.50	3	016700120
250	165	42.00	3	016700125
300	175	49.50	3	016700130
400	230	64.50	2	016700140
500	280	86.00	2	016700150
600	330	96.50	2	016700160
800	420	114.50	1	016700180
1000	500	142.50	1	016700199

1672

Fausse équerre à coulisse lame et talon en acier

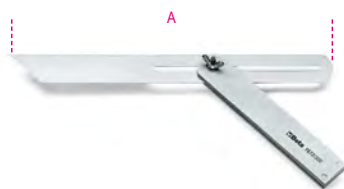

A mm	CHF		
300	69.00	2	016720030

1672A

Fausse équerre à coulisse en acier chromée, talon en aluminium

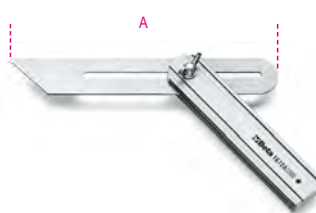

A mm	CHF		
200	36.00	3	016720120
300	39.50	3	016720130

1674A

Équerre de menuisier, lame en acier talon en aluminium, double échelle millimétrique



L mm	L1 mm	CHF		
300	169	34.00	2	016740130
400	214	42.50	2	016740140

1676

Rapporteur d'angles simple en acier inoxydable

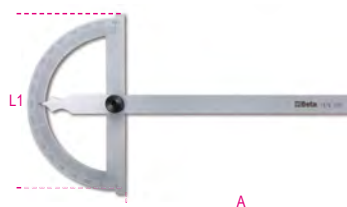

A	A mm	L1 mm	G mm	CHF		
120	120	80	1°	54.00	2	016760012
150	165	120	1°	62.00	2	016760015
200	210	150	1°	74.50	2	016760020
300	310	200	1°	100.50	1	016760030

1678/C3

Rapporteur d'angles en acier inoxydable

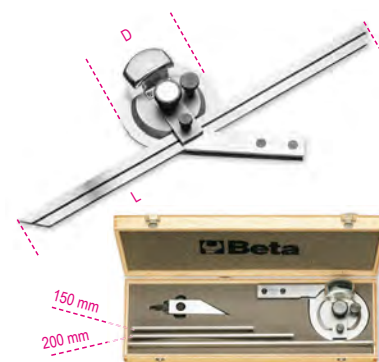

L Max mm	D mm	CHF		
300	70	382.00	1	016780030

1679

Pied à coulisse à tracer à molette en acier inoxydable, précision au 1/10e

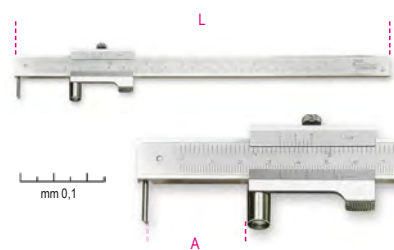

L mm	A Max mm	CHF		
235	200	115.50	1	016790020

1679/PR

Pointe pour pied à coulisse 1679



CHF		
18.60	1	016790021

1680

Compas à verge corps et pointes de traçage en acier trempé

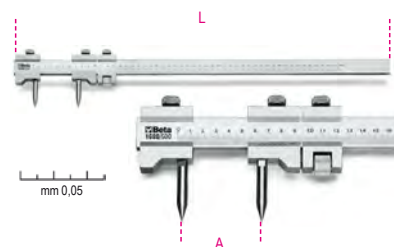

L mm	A Max mm	CHF		
660	500	382.00	1	016800050

1680A

Compas d'intérieur

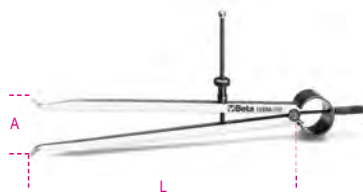

L mm	A Max mm	CHF		
150	144	24.90	2	016800115
200	200	30.50	2	016800120
250	245	38.00	1	016800125
300	300	43.50	1	016800130

1680B

Compas d'épaisseur



L mm	A Max mm	CHF		
150	155	24.90	2	016800215
200	190	30.50	2	016800220
250	235	38.00	1	016800225
300	280	43.50	1	016800230

1680C

Compas à pointes sèches
pointes droites en acier trempé



L mm	A Max mm	CHF		
150	138	24.90	2	016800315
200	190	30.50	2	016800320
250	235	38.00	1	016800325
300	280	43.50	1	016800330

1682

Réglet flexible en acier inoxydable



L mm	H mm	± mm	CHF		
150	13	0,5	4.05	5	016820015
200	13	0,5	4.35	5	016820020
250	13	0,5	5.40	5	016820025
300	13	0,5	6.70	5	016820030
500	13	0,5	15.10	2	016820050
1000	13	0,5	39.50	2	016820100

1683

Réglet semi-rigide en acier inoxydable

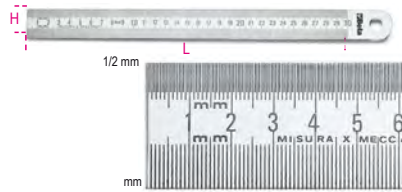

L mm	H mm	± mm	CHF		
300	30	1	11.90	5	016830030
500	30	1	19.80	2	016830050
1000	30	1	49.50	2	016830100
1500	30	1	111.00	1	016830150

1685/C7

Coffret de 7 outils de métrologie



1685/C7	CHF		
	389.00	1	016850110

	1650	160 mm
	1658/25	0+25 mm
	1670	100 mm
	1680C	150 mm
	1682	150 mm
	1688BC	165 mm
	1688BC/R	

320x210x37 mm - 1,2 kg

1687A

Pointe de précision coudée 90°
avec manche



1687A	L mm	L1 mm	CHF		
	153	80	8.45	1	016870120

1687AC

Pointe de précision courte coudée
avec manche



1687AC	L mm	L1 mm	CHF		
	153	80	8.45	1	016870125

1687D

Pointe de précision droite
avec manche



1687D	L mm	L1 mm	CHF		
	153	80	8.45	1	016870110

1687U

Pointe de précision à crochet
avec manche



1687U	L mm	L1 mm	CHF		
	153	80	8.45	1	016870115

1687/S4

Jeu de 4 pointes de précision
avec manche



1687/S4	CHF		
1687A-1687AC 1687D-1687U	33.50	1	016870150

1688

Pointe à tracer en acier trempé



1688	L mm	Ø mm	CHF		
	250	2	11.10	5	016880020

1688A

Pointe à tracer en carbure



1688A	L mm	Ø mm	CHF		
	200	4	20.10	5	016880120

1688PC

Pointe à tracer rétractable en carbure en acier trempé chromé



	L mm	Ø mm	CHF		
1688PC	150	1	47.50	1	016880300

1688PC/R

Pointe pour 1688PC



	CHF		
1688PC/R	13.90	1	016880310

1688M

Crayon de menuisier



	L mm	CHF		
1688M	180	1.44	50	016880880

1690F

Mètre pliant en fibre de verre classe de précision III

CE



	L m	S mm	CHF		
1690F/2	2	17	15.80	5	016900220

1690L

Mètre pliant en bois de bouleau classe de précision III

CE



	L m	S mm	CHF		
1690L/2	2	17	17.20	5	016900200

Beta

1691BM

Mètre à ruban
boîtier ABS antichoc bi-matières
Ruban en acier
Classe de précision : II

CE



	L m	S mm	CHF		
1691BM/5	5	25	20.70	1	016910205
1691BM/8	8	32	31.00	1	016910208
1691BM/10	10	32	38.00	1	016910210

1691MG

Mètre à ruban avec aimant fixe
boîtier ABS antichoc bi-matières
Ruban en acier
Classe de précision : II

CE



	L m	S mm	CHF		
1691MG/5	5	25	18.60	1	016910405
1691MG/8	8	25	26.00	1	016910408
1691MG/10	10	25	27.50	1	016910410

1692

Mètre à ruban
boîtier ABS antichoc bi-matières
ruban en acier
classe de précision: II

CE



	L m	S mm	CHF		
1692/2	2	16	10.10	5	016920052
1692/3	3	16	12.50	5	016920053
1692/5	5	19	17.90	5	016920055
1692/8	8	25	26.00	5	016920058

1693

Appareil de mesure de distance laser
20 mètres

MESURES :

- mesure de distance simple
- mesure continue ou mesurage minimum

Arrêt automatique



CE
IP54

DONNÉES TECHNIQUES

Champ de mesure : de 0,05 à 20m (de 0.2ft à 66ft)
Sélection échelle : m, in, ft
Précision : ±1,5 mm (± 0.06 in)
Classe Laser : 2
Batteries : AAA 2 x 1.5V

	H mm	L mm	S mm	CHF		
1693 20	100	36	23	158.50	1	016930020

1693M

Appareil de mesure de distance laser
multifonction,
80 m

MESURES :

- mesure de distance simple
- mesure continue ou mesurage minimum

FONCTIONS :

- addition/soustraction
- mesure de la zone
- mesure du volume
- Mesure indirecte (mesure de Pythagore)
- Mesure de l'inclinaison

Arrêt automatique

Étui souple en toile (inclus)

Durée batterie : jusqu'à 4.000 mesurages



CE
IP54

DONNÉES TECHNIQUES

Champ de mesure : de 0,05 à 80 m (de 0.2 pieds à 229 pieds)
Sélection échelle : m, pouces, pieds
Précision : ±1,5 mm (± 0,06 pouces)
Classe Laser : 2
Mémorisation mesures : 99
Batteries : AAA 2 x 1,5 V

	H mm	L mm	S mm	CHF		
1693M 80	115	48	29	269.00	1	016930080

Beta

1694/L

Mesure longue à ruban
boîtier en ABS antichoc,
ruban en fibre de verre recouvert de PVC,
classe de précision III



	L m	S mm	CHF		
1694L10	10	13	16.60	1	016940110
1694L20	20	13	20.70	1	016940120

1694A/L

Mesure longue à ruban à poignée
boîtier en ABS antichoc
ruban en fibre de verre recouvert de PVC
classe de précision III



	L m	S mm	CHF		
1694A/L30	30	13	41.50	1	016940230
1694A/L50	50	13	54.00	1	016940250

1694B/L

Mesure longue à ruban
à poignée revolver corps en aluminium,
ruban en acier verni,
classe de précision II



	L m	S mm	CHF		
1694B/L50	50	12,5	82.50	1	016940350

Beta

1695XS

Niveau de poche avec base en "V"
magnétique en aluminium profilé
2 fioles incassables
précision : 1 mm/m



L mm	H mm	S mm	CHF		
70	48,5	20	17.00	5	016950250

1696

Niveau tubulaire aluminium,
surfaces anodisées, avec fioles
incassables, précision : 1 mm/m .



L mm	H mm	S mm	CHF		
200	50	19	28.50	2	016960002
400	50	19	33.00	2	016960004
500	50	19	36.00	2	016960005
600	50	19	38.50	2	016960006
800	50	19	47.50	2	016960008
1000	50	19	53.50	2	016960010

1696A

Niveau trapézoïdal corps en aluminium
moulé sous pression,
avec 1 semelle rectifiée
et 2 fioles incassables, précision 1 mm/m



L mm	H mm	S mm	CHF		
300	43	23	41.00	2	016960103
400	43	23	43.50	2	016960104
500	43	23	47.00	2	016960105
600	43	23	51.50	2	016960106
800	43	23	82.50	1	016960108
1000	43	23	103.50	1	016960110

1696B

Niveau tubulaire aluminium avec semelle
magnétique
corps en profilé aluminium,
surfaces anodisées 2 fioles incassables,
précision: 1 mm/m



L mm	H mm	S mm	CHF		
200	49	22	44.00	2	016960202
300	49	22	46.00	2	016960203
400	49	22	48.50	2	016960204
500	49	22	59.00	2	016960205
600	49	22	62.00	2	016960206

1696D

Niveau corps en aluminium moulé sous
pression, avec 4 bases rectifiées et 3 fioles
incassables,
précision 1 mm/m



L mm	H mm	S mm	CHF		
300	47	25	38.50	2	016960353
400	47	25	43.50	2	016960354
500	47	25	47.00	2	016960355
600	47	25	53.50	2	016960356

1696S

Niveau de maçon corps en aluminium
avec 2 fioles incassables
précision 1 mm/m



L mm	H mm	S mm	CHF		
1500	90	25	135.50	1	016960415
2000	90	25	162.00	1	016960420
2500	90	25	201.50	1	016960425
3000	90	25	227.50	1	016960430

Beta

Beta

1697

niveau laser croisé,
30 metres, faisceau vert,
avec base magnétique et support mural,
en coffret

SPÉCIFICATIONS TECHNIQUES:

- croix auto-nivelante
- la fonction d'auto-nivellement peut être désactivée pour une utilisation manuelle
- diode laser 515 Nm, classe 2
- plage de travail: 30 m
- précision : ± 1 mm à 5 m
- plage d'auto-nivellement : $3^\circ \pm 0,5^\circ$
- corps en ABS et caoutchouc antidérapant
- Lecteur femelle 1/4 »
- 2 pilesXA
- autonomie de la batterie: 4 heures BASE:
- 1 base magnétique pour usage individuel et combiné, entraînement mâle 1/4 »
- 1 support de serrage réglable pour plusieurs profilés en bois et en métal (à utiliser en combinaison avec une base magnétique)
- alignement horizontal et vertical rapide à un angle de 90°

CE



IP55

H mm	L mm	S mm	CHF	Unit	Code
82	57	89,5	336.00	1	016970030

320x230x90 mm

1699L

Niveau droit de haute précision corps
en fonte avec semelles rainurées
en V rectifiées et 2 fioles incassables,
précision = 0,05 mm/m



DIN 877

L mm	A mm	CHF	Unit	Code
1699L 200	49	407.00	1	016990002

1699L/1

Niveau droit de haute précision corps
en fonte avec semelles rainurées
en V rectifiées et 2 fioles incassables,
précision = 0,02 mm/m



DIN 877

L mm	A mm	CHF	Unit	Code
1699L/1 200	49	433.00	1	016990005

16990

Niveau à cadre de précision corps
en fonte, semelles rectifiées
(2 rainurées en V et 2 planes)
et 2 fioles incassables,
précision = 0,05 mm/m

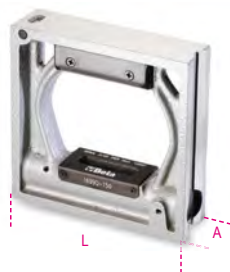

DIN 877

L mm	A mm	CHF	Unit	Code
150	40	577.00	1	016990015
200	48	720.00	1	016990020

1700N

Broche de maçon



L mm	S mm	CHF	Unit	Code
250	16	21.00	5	017000005
300	16	22.70	5	017000006

1700N/PM

Broche de maçon avec protecteur



L mm	S mm	CHF	Unit	Code
250	16	28.00	2	017000105
300	16	33.00	2	017000106

1701N

Ciseau de maçon



L mm	A mm	S mm	CHF	Unit	Code
250	23	16	22.60	5	017010001
300	23	16	24.30	5	017010003

1701N/PM

Ciseau de maçon avec protecteur



L mm	A mm	S mm	CHF	Unit	Code
250	23	16	29.00	2	017010101
300	23	16	33.00	2	017010103

1701PMR

Protecteur pour 1700N et 1701N



D mm	L mm	CHF	Unit	Code
16	115	13.50	1	017010206

1701NE/...

Ciseau d'électricien



SxL mm	CHF	Unit	Code
1701NE3 10x200	13.90	5	017010406
1701NE4 10x250	14.80	5	017010409

1702N

Burin large



A mm	SxH mm	CHF	Unit	Code
50	13x23	29.50	2	017020005
70	13x23	30.00	2	017020007

1702N/PM

Burin large avec protecteur



A mm	SxH mm	CHF	Unit	Code
50	13x23	36.00	2	017020105
70	13x23	39.50	2	017020107

 Il est recommandé de refroidir fréquemment l'outil pendant le réaffûtage

1702PMR

Protecteur pour 1702N



L mm	CHF	Unit	Code
115	10.50	1	017020200

1704
Pince à décoffrer

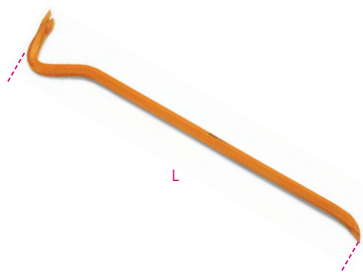

L mm	6 mm	mm	mm	CHF		
500	16	35	28	38.00	2	017040050
600	16	34	26	42.50	2	017040060
800	18	38	29	60.00	2	017040080

1704A
Barre à mine

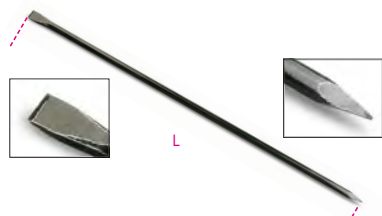

L mm	6 mm	mm	CHF		
1500	25	45	118.00	1	017040110
2000	28	55	150.50	1	017040120

1704C
Pince à talon



L mm	8 mm	MIN-MAX mm	mm	CHF		
1200	21-31	39		129.50	1	017040210
1400	31-37	42		155.00	1	017040212
1600	25-37	42		192.00	1	017040215

1705
Cordeau à tracer en aluminium



L m	CHF		
1705 30	25.50	4	017050001

1705PT
Poudre à tracer



g	CHF		
250	16.30	5	017050025

1706DGT
Jauge de profondeur digitale pour le contrôle d'usure des pneus



1706DGT	CHF		
	47.50	1	017060011

1707
Jauges de filetage
Pour filets métriques ISO à 60° et Whitworth à 55°.



P (ISO)	W	CHF		
0,25÷6	62÷4x1"	22.70	5	017070001

1707A/1 - 2 - 3
Jauges à rayons, lames concaves et convexes en acier



R mm	L mm	n	CHF		
1707A/1 1,0÷7,0	70	34	34.50	2	017070007
1707A/2 7,5÷15	85	32	38.00	2	017070015
1707A/3 15,5÷25	85	30	38.00	2	017070025

1708/8 - 13 - 20
Jauges d'épaisseur

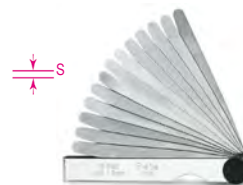

	CHF		
1708/8 S = 0,05±0,50 mm	8.60	5	017080008
1708/13 S = 0,05±1,00 mm	9.75	5	017080013
1708/20 S = 0,05±1,00 mm	15.80	5	017080020

1709/10 - 1709/18
Casse-écrous



	L mm	A max mm	CHF		
1709/10	90	17 (M10)	69.00	1	017090010
1709/18	108	25 (M16)	76.00	1	017090018

1710
Casse-écrous hydraulique



	C min mm	C max mm	CHF		
	7 (M4)	22 (M14)	316.00	1	017100001

1712E/1 - 2 - 3
Doigt magnétique flexible

F = force magnétique



	L mm	D mm	F kg	CHF		
1712E/1	420	7,5	0,5	41.00	2	017120011
1712E/2	530	15	1,8	51.50	2	017120012
1712E/3	532	19	3,0	64.00	2	017120013

1712TF
Aimant télescopique avec tête flexible

• Avec nettoyeur pour gicleurs lave-vitres
F = force magnétique



	L mm	D mm	F kg	CHF		
	150÷590	11	1	27.00	1	017120600

1713M

Doigt mécanique flexible à griffes

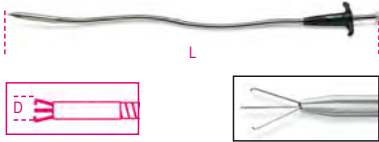

L mm	D mm	CHF	🔧	📦
500	7	56.50	2	017130011
1000	7	100.00	1	017130015

1714

Miroir d'inspection en plastique



L mm	D mm	CHF	🔧	📦
1714	155	25	4.95	5 017140001

1715

Miroir d'inspection télescopique, monture en métal chromé



L mm	D mm	CHF	🔧	📦
1715	180+540	30	42.50	1 017150001

1715FL/A

Miroir d'inspection flexible carré



L mm	A mm	B mm	CHF	🔧	📦
1715FL/A	600	53	90	51.00	1 017150110

1715R/FL

2 miroir d'inspection pour 1715FL/A et 1715FL/B

CHF	🔧	📦
1715R/FL	10.80	1 017150151

1715FL/B

Miroir d'inspection flexible rectangulaire avec lampe

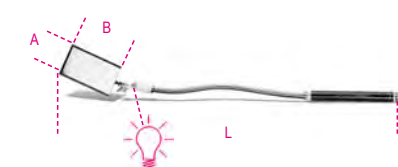

L mm	A mm	B mm	CHF	🔧	📦
1715FL/B	553	53	90	60.50	1 017150115

1715B/R5L

Kit de 5 ampoule pour 1715FL/B

CHF	🔧	📦
1715B/R5L	8.75	1 017150152

1716A

Pointe coudée



L mm	L1 mm	mm	CHF	🔧	📦
1716A	240	125	6	14.60	3 017160040

1716P

Grattoir pour joints



L mm	L1 mm	mm	CHF	🔧	📦
1716P	250	125	6	18.00	3 017160020

1716Q

Pointe carrée



L mm	L1 mm	mm	CHF	🔧	📦
1716Q	215	100	6	12.50	5 017160010

1716R

Pointe ronde



L mm	L1 mm	mm	CHF	🔧	📦
1716R	215	100	6	12.50	5 017160001

1716U

Pointe à crochet



L mm	L1 mm	mm	CHF	🔧	📦
1716U	195	80	6	14.60	3 017160025

1717A

Grattoir feuille de sauge



L mm	L1 mm	L2 mm	CHF	🔧	📦
150	70	260	27.50	2	017170015
200	75	310	29.50	2	017170020
250	100	360	33.00	2	017170025

1717B

Grattoir triangulaire



L mm	L1 mm	L2 mm	CHF	🔧	📦
150	75	260	23.90	2	017170115
200	85	310	28.00	2	017170120
250	100	360	31.00	2	017170125

1717C

Grattoir droit plat



L mm	S mm	L1 mm	CHF	🔧	📦
150	18	270	23.70	2	017170215
200	20	320	26.50	2	017170220
250	25	370	29.50	2	017170225

1717D

Grattoir droit plat à coupe frontale



L mm	S mm	L1 mm	CHF	🔧	📦
1717D 150	150	23 240	32.00	2	017170320

1717T

Grattoir à lame triangulaire fourni avec 2 lames



L mm	CHF	🔧	📦
1717T	310	15.10	1 017170610

1717T RT

Lame triangulaire de rechange



L mm	CHF	🔧	📦
1717T RT	65	3.15	1 017170660

1717T RS

Lame façonnée de rechange



CHF	🔧	📦
1717T RS	3.15	1 017170661

1717V

Grattoir pour vernis avec lame utilisable sur plusieurs côtés



	L mm	A mm	CHF		
1717V 38	200	38	10.20	1	017170703
1717V 65	285	65	21.70	1	017170706

1717V R

Lame de rechange pour 1717V



	L mm	CHF		
1717V R38	38	3.15	1	017170753
1717V R65	65	4.45	1	017170756

CUTTERS

RUGEUX

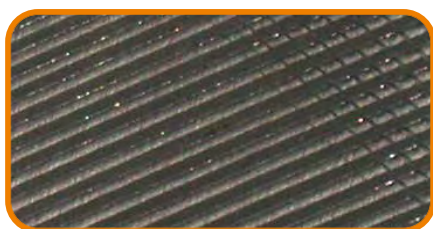

DEUXIEME COUPE

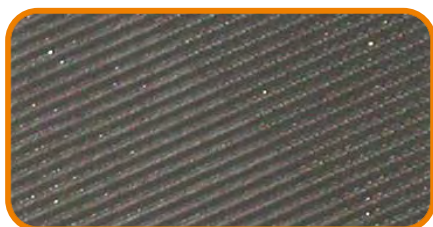

LISSE



1718D...Q

Lime carrée grossière, sans manche

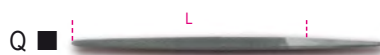

	L mm	L "	CHF		
1718D6/Q	150	6	12.00	5	017180121
1718D8/Q	200	8	14.30	5	017180131
1718D10/Q	250	10	19.40	5	017180141

1718A...Q

Lime carrée demi-douce, sans manche

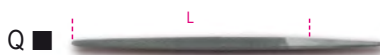

	L mm	L "	CHF		
1718A6/Q	150	6	12.20	5	017180021
1718A8/Q	200	8	14.80	5	017180031
1718A10/Q	250	10	20.20	5	017180041

1718D...T

Lime triangulaire grossière, sans manche



	L mm	L "	CHF		
1718D6/T	150	6	14.40	5	017180123
1718D8/T	200	8	18.40	5	017180133
1718D10/T	250	10	24.20	5	017180143

1718A...T

Lime triangulaire demi-douce, sans manche



	L mm	L "	CHF		
1718A6/T	150	6	14.80	5	017180023
1718A8/T	200	8	18.70	5	017180033
1718A10/T	250	10	25.50	5	017180043

1718D...P

Lime plate grossière, sans manche



	L mm	L "	CHF		
1718D6/P	150	6	11.30	5	017180125
1718D8/P	200	8	13.30	5	017180135
1718D10/P	250	10	17.90	5	017180145

1718A...P

Lime plate demi-douce, sans manche



	L mm	L "	CHF		
1718A6/P	150	6	12.00	5	017180025
1718A8/P	200	8	13.80	5	017180035
1718A10/P	250	10	19.40	5	017180045

1718D...M

Lime demi-ronde grossière, sans manche



	L mm	L "	CHF		
1718D6/M	150	6	15.90	5	017180127
1718D8/M	200	8	19.50	5	017180137
1718D10/M	250	10	25.50	5	017180147

1718A...M

Lime demi-ronde demi-douce, sans manche



	L mm	L "	CHF		
1718A6/M	150	6	16.10	5	017180027
1718A8/M	200	8	20.00	5	017180037
1718A10/M	250	10	26.50	5	017180047

1718D...R

Lime ronde grossière, sans manche



	L mm	L "	CHF		
1718D6/R	150	6	11.30	5	017180129
1718D8/R	200	8	13.30	5	017180139
1718D10/R	250	10	17.50	5	017180149

1718A...R

Lime ronde demi-douce, sans manche



	L mm	L "	CHF		
1718A6/R	150	6	12.00	5	017180029
1718A8/R	200	8	13.80	5	017180039
1718A10/R	250	10	18.50	5	017180049

1718D...S5

Jeu de 5 limes grossières, sans manche



	L mm	L "	CHF		
1718D6/S5	150	6	64.50	1	017180130
1718D8/S5	200	8	78.50	1	017180140
1718D10/S5	250	10	104.00	1	017180150

Beta
Quality Tools

1718A...S5

Jeu de 5 limes demi-douce, sans manche



■ Q
▲ T
▮ P
▷ M
● R

	L mm	L "	CHF	5	1
1718A6/S5	150	6	67.00	1	017180030
1718A8/S5	200	8	81.00	1	017180040
1718A10/S5	250	10	109.50	1	017180050

1719BMD...Q

Lime carrée grossière, avec manche



	L mm	L "	CHF	5	1
1719BMD6/Q	150	6	16.40	5	017190191
1719BMD8/Q	200	8	18.10	5	017190221
1719BMD10/Q	250	10	24.80	5	017190241
1719BMD12/Q	300	12	32.00	3	017190325

1719BMA...Q

Lime carrée demi-douce, avec manche



	L mm	L "	CHF	5	1
1719BMA6/Q	150	6	16.50	5	017190021
1719BMA8/Q	200	8	19.70	5	017190052
1719BMA10/Q	250	10	26.00	5	017190071
1719BMA12/Q	300	12	38.00	3	017190311

1719BMX...Q

Lime carrée douce, avec manche



	L mm	L "	CHF	5	1
1719BMX6/Q	150	6	17.60	5	017190022
1719BMX8/Q	200	8	22.70	5	017190053
1719BMX10/Q	250	10	30.50	5	017190072

1719BMD...T

Lime triangulaire grossière, avec manche



	L mm	L "	CHF	5	1
1719BMD6/T	150	6	19.50	5	017190193
1719BMD8/T	200	8	22.30	5	017190223
1719BMD10/T	250	10	30.00	5	017190243
1719BMD12/T	300	12	42.50	3	017190326

1719BMA...T

Lime triangulaire demi-douce, avec manche



	L mm	L "	CHF	5	1
1719BMA6/T	150	6	19.50	5	017190023
1719BMA8/T	200	8	24.20	5	017190054
1719BMA10/T	250	10	31.00	5	017190073
1719BMA12/T	300	12	44.50	3	017190313

1719BMX...T

Lime triangulaire douce, avec manche



	L mm	L "	CHF	5	1
1719BMX6/T	150	6	23.10	5	017190024
1719BMX8/T	200	8	30.00	5	017190055
1719BMX10/T	250	10	38.50	5	017190074

1719BMD...P

Lime plate grossière, avec manche



	L mm	L "	CHF	5	1
1719BMD6/P	150	6	16.40	5	017190195
1719BMD8/P	200	8	17.20	5	017190225
1719BMD10/P	250	10	24.30	5	017190245
1719BMD12/P	300	12	31.50	3	017190327

1719BMA...P

Lime plate demi-douce, avec manche

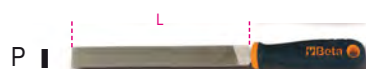

	L mm	L "	CHF	5	1
1719BMA6/P	150	6	17.20	5	017190025
1719BMA8/P	200	8	19.50	5	017190056
1719BMA10/P	250	10	25.00	5	017190075
1719BMA12/P	300	12	36.00	3	017190315

1719BMX...P

Lime plate douce, avec manche



	L mm	L "	CHF	5	1
1719BMX6/P	150	6	17.60	5	017190026
1719BMX8/P	200	8	23.10	5	017190057
1719BMX10/P	250	10	30.00	5	017190076

1719BMD...M

Lime demi-ronde grossière, avec manche



	L mm	L "	CHF	5	1
1719BMD6/M	150	6	21.50	5	017190197
1719BMD8/M	200	8	23.10	5	017190227
1719BMD10/M	250	10	31.00	5	017190247
1719BMD12/M	300	12	43.50	3	017190328

1719BMA...M

Lime demi-ronde demi-douce, avec manche



	L mm	L "	CHF	5	1
1719BMA6/M	150	6	22.30	5	017190027
1719BMA8/M	200	8	26.00	5	017190058
1719BMA10/M	250	10	33.50	5	017190077
1719BMA12/M	300	12	47.50	3	017190317

1719BMX...M

Lime demi-ronde douce, avec manche



	L mm	L "	CHF	5	1
1719BMX6/M	150	6	23.80	5	017190028
1719BMX8/M	200	8	29.50	5	017190059
1719BMX10/M	250	10	41.00	5	017190078

1719BMD...R

Lime ronde grossière, avec manche



	L mm	L "	CHF	5	1
1719BMD6/R	150	6	16.40	5	017190199
1719BMD8/R	200	8	17.00	5	017190229
1719BMD10/R	250	10	23.70	5	017190249
1719BMD12/R	300	12	31.00	3	017190329

1719BMA...R

Lime ronde demi-douce, avec manche



	L mm	L "	CHF	5	1
1719BMA6/R	150	6	17.40	5	017190029
1719BMA8/R	200	8	19.20	5	017190060
1719BMA10/R	250	10	24.60	5	017190079
1719BMA12/R	300	12	33.00	3	017190319

1719BMX...R

Lime ronde douce, avec manche



	L mm	L "	CHF		
1719BMX6/R	150	6	20.00	5	017190031
1719BMX8/R	200	8	22.30	5	017190061
1719BMX10/R	250	10	30.00	5	017190081

1719BMA...B5

Jeu de 5 limes demi-douces, avec manche, en étui



	L mm	L "	CHF		
1719BMA8/B5	200	8	108.50	1	017190297
1719BMA10/B5	250	10	140.00	1	017190298

1719BMD...B5

jeu de 5 limes grossières, avec manche, en étui



	L mm	L "	CHF		
1719BMD8/B5	200	8	98.00	1	017190303
1719BMD10/B5	250	10	134.00	1	017190305

1719BMD...S5

Jeu de 5 limes grossières, avec manche

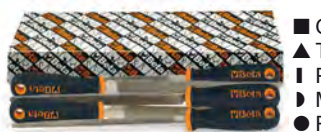

	L mm	L "	CHF		
1719BMD6/S5	150	6	90.00	1	017190200
1719BMD8/S5	200	8	98.00	1	017190230
1719BMD10/S5	250	10	134.00	1	017190250
1719BMD12/S5	300	12	181.00	1	017190363

1719BMA...S5

Jeu de 5 limes demi-douces, avec manche



	L mm	L "	CHF		
1719BMA6/S5	150	6	93.00	1	017190030
1719BMA8/S5	200	8	108.50	1	017190070
1719BMA10/S5	250	10	140.00	1	017190080
1719BMA12/S5	300	12	199.00	1	017190361

1719BMX...S5

Jeu de 5 limes douces, avec manche



	L mm	L "	CHF		
1719BMX6/S5	150	6	102.50	1	017190032
1719BMX8/S5	200	8	127.50	1	017190069
1719BMX10/S5	250	10	170.50	1	017190082

1719BMB/P

Limes plates aluminium
manche en matériau plastique



	L mm	L "	CHF		
1719BM/P250	250	10	38.50	5	017190152
1719BM/P300	300	12	45.00	5	017190153

1719BMC

Limes demi-rondes et plates d'entrée
manche en matériau plastique

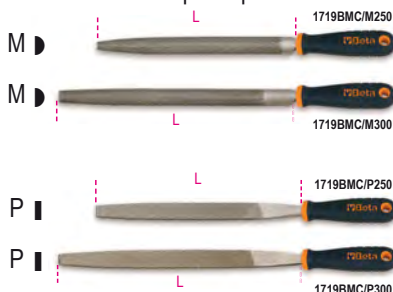

UNI 5569 - UNI 5568

	L mm	L "	CHF		
1719BMC/M 250	250	10	26.00	6	017190252
1719BMC/M 300	300	12	32.00	4	017190253
1719BMC/P 250	250	10	20.30	6	017190262
1719BMC/P 300	300	12	25.00	4	017190263

1719BM/RR

Râpe ronde
manche en matériau plastique



	L mm	L "	CHF		
1719BM/RR	200	8	21.30	5	017190351

1719BM/RL

Râpe lime plate
manche en matériau plastique



	L mm	L "	CHF		
1719BM/RL	200	8	20.30	5	017190360

1719BMR

Manche de rechange pour limes



	L mm	A mm	CHF		
1719BMR/0	95	25	4.65	10	017190950
1719BMR/0B	110	29	4.65	10	017190955
1719BMR/1	110	29	4.65	10	017190951
1719BMR/1B	110	29	4.65	10	017190953
1719BMR/2	123	31	4.65	10	017190952
1719BMR/2B	123	31	4.65	10	017190954

	mm	"		
1719BMR/0	100/150	4/6	▲▲	●
1719BMR/0B	100/150	4/6	■	●
1719BMR/1	150/200	6/8	▲▲	●
1719BMR/1B	150/200	6/8	■	●
1719BMR/2	250/300	10/12	▲▲	●
1719BMR/2B	250/300	10/12	■	●

1720/...

Lime semi-douce,
tige Ø 3 mm

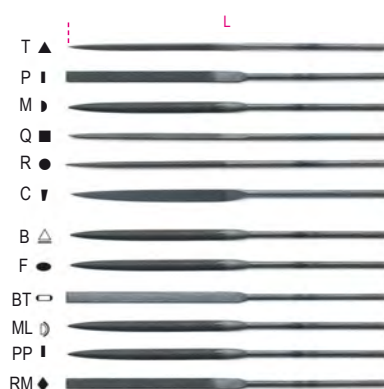

UNI 5569 UNI 5670

	L mm	CHF		
1720T	160	9.35	5	017200004
1720P	160	9.35	5	017200006
1720M	160	9.35	5	017200008
1720Q	160	9.35	5	017200009
1720R	160	9.35	5	017200010
1720C	160	9.35	5	017200012
1720B	160	9.35	5	017200005
1720ML	160	9.35	5	017200007
1720BT	160	9.35	5	017200011
1720F	160	9.35	5	017200013
1720PP	160	9.35	5	017200014
1720RM	160	9.35	5	017200015



	CHF		
1720/S3	28.00	1	017200000

1720/B

trousse de 6 limes semi-douce



	CHF		
1720/B6	59.00	1	017200002
1720/B12	112.00	1	017200003

1720D/...

Lime diamantée,
grain D126



	L mm	CHF		
1720D/T	160	60.50	2	017200104
1720D/P	160	60.50	2	017200106
1720D/M	160	60.50	2	017200108
1720D/Q	160	60.50	2	017200109
1720D/R	160	60.50	2	017200110
1720D/C	160	60.50	2	017200112



	CHF		
1720D/B6	367.00	1	017200120

1721/B6

Jeu de 6 limes pour contacts



	CHF		
1721/B6	31.00	1	017210010

1723

Tire-ressorts



	L mm	CHF		
1723	210	20.20	5	017230001

1725

Monture de scie à métaux avec lame



	L mm	L1 mm	CHF		
1725	420	300	28.00	4	017250001

1725CR

Monture de scie de précision
en aluminium



	L mm	L1 mm	CHF		
1725CR	250	150	15.30	5	017250010

1726

Monture de scie à métaux
avec système de tension
de lame intégré



	L mm	L1 mm	CHF		
1726	440	300	37.00	4	017260001

1726BM

Monture de scie à métaux avec système
de tension de la lame à déclenchement



	L mm	L1 mm	CHF		
1726BM	400	300	60.00	1	017260050

1727

Monture de scie à métaux
type soudeur avec lame

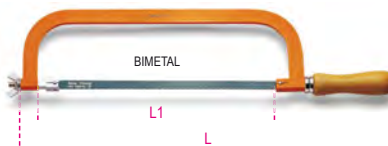

	L mm	L1 mm	CHF		
1727	515	300	25.50	4	017270001

1727BM

Monture de scie
à métaux monobloc



	L mm	L1 mm	CHF		
1727BM	315	300	31.00	5	017270020

1728...

Lame de scie



	CHF		
1728LA	1.83	100	017280001
1725CR			
1725MQ			
1728BM	4.60	100	017280010
1725-1726			
1727-1727M			
1728CO	6.35	50	017280030
1725-1726			
1727-1727M			

1729CG

Monture de scie pour placoplâtre



	L mm	L1 mm	CHF		
1729CG	310	160	30.50	2	017290200

1729DM 450

Scie égoïne à bois

denture moyenne, 12 dents par pouce



	L mm	L1 mm	CHF		
1729DM 450	450	400	34.50	4	017290450

1730

Spatule universelle avec lame en acier
inoxydable et manche



S mm	L mm	L1 mm	CHF		
38	210	85	7.75	2	017300038
63	220	95	9.25	2	017300063
75	220	95	10.10	2	017300075
100	220	95	11.50	2	017300100

1730M

Spatule pour mélangeurs
avec lame en acier inoxydable et manche



L1 mm	L mm	S mm	CHF		
150	245	27	10.80	2	017300215
200	330	28	20.20	2	017300220
250	365	36	24.90	2	017300225

1730V 38

Spatule pour vitriers
avec lame à couteau en acier inoxydable



S mm	L mm	L1 mm	CHF		
38	225	100	7.75	2	017300338

1736A

Carde à lime
fils d'acier inoxydable
Ø fil 0,5 mm



1736A	L mm 240	CHF 14.10	10	017360010
-------	----------------	--------------	----	-----------

1737

Brosse à bougies en fils de cuivre ondulé,
Ø fil 0,2 mm



1737	L mm 145	CHF 6.80	10	017370001
------	----------------	-------------	----	-----------

1737NX

Brosse métallique en fils d'acier cuivré,
Ø fil 0,3 mm



1737NX	L mm 270	CHF 8.15	5	017370010
--------	----------------	-------------	---	-----------

1737AC

Brosse métallique en fils d'acier
à 5 rangées,
Ø fil 0,3 mm



1737AC	L mm 275	CHF 7.75	5	017370020
--------	----------------	-------------	---	-----------

1737B

Paire de nettoyeurs
de cosses et bornes
de batterie
fils en acier
Ø fil 0,3 mm



1737B	CHF 19.20	1	017370050
-------	--------------	---	-----------

1738

Pinceau de nettoyage



1738	L mm 210	H mm 30	CHF 11.10	10	017380001
------	----------------	---------------	--------------	----	-----------

1739B

Pince à riveter à extenseur
avec 5 embouts



Ø mm	3,2	4	4,8	5	6	6,4
Aluminium	•	•	•	•	•	•
Acier inoxydable	•	•	•	•		

1739B	CHF 163.00	1	017390151
-------	---------------	---	-----------

1740A

Pince à riveter gros effort
avec 5 embouts



Ø mm	3,2	4	4,8	5	6	6,4
Aluminium	•	•	•	•	•	•
Acier inox	•	•	•	•		

1740A	CHF 148.00	1	017400101
-------	---------------	---	-----------

1740B

Pince à riveter gros effort compacte



Ø mm	2,4	3	3,2	3,2	4,8
Aluminium	•	•	•	•	•
Acier inox	•	•	•	•	•
Inox	•	•	•	•	•

1740B 280	L mm 280	CHF 96.00	1	017400280
-----------	----------------	--------------	---	-----------

Ø mm	2,4	3,2	4,0	4,8	6,4
Aluminium	•	•	•	•	•
Acier inox	•	•	•	•	•
Inox	•	•	•	•	•

1740B 330	L mm 330	CHF 111.00	1	017400330
-----------	----------------	---------------	---	-----------

1741B

Pince à riveter
avec 4 embouts



Ø mm	2,4	3,2	4	4,8	5
Aluminium	•	•	•	•	•
Acier	•	•	•	•	•
Inox	•	•	•		

1741B	CHF 51.00	1	017410000
-------	--------------	---	-----------

Beta

Beta

1741B/C5

Pince à riveter 1741B avec assortiment de 700 rivets en aluminium



1741B/C5 CHF 158.50 1 017410025

	Ø mm	L mm	n.
1741RV2,9K	3,0	6	200
1741RV3,2K	3,2	8	200
1741RV3,8K	4,0	10	100
1741RV4K	4,0	12	100
1741RV4,8K	4,8	12	100

415x155x60 mm - 3,1 Kg

1741BP

Pince à riveter avec 4 embouts



Ø mm	2,4	3,2	4	4,8	5
Aluminium	•	•	•	•	•
Acier	•	•	•	•	•
Inox	•	•	•	•	•

1741BP CHF 77.50 1 017410350

1741U

Pince à riveter ultra compacte avec réglage de l'effort

avec 4 embouts
3 griffes : meilleure prise du rivet



Ø mm	2,4	3	3,2	4	4,8
Aluminium	•	•	•	•	•
Acier	•	•	•	•	•
Acier inoxydable	•	•	•	•	•

1741U CHF 60.00 1 017410450

1741RV...K

Rivets en aluminium



	CHF	1	017410191
1741RV 2,9K ØxL = 3x6 mm	25.50	1	017410191
1741RV 3,2K ØxL = 3,2x8 mm	26.00	1	017410192
1741RV 3,8K ØxL = 4x10 mm	33.00	1	017410193
1741RV 4K ØxL = 4x12 mm	36.00	1	017410194
1741RV 4,8K ØxL = 4,8x12 mm	44.50	1	017410195

Les prix indiqués sont pour 500 pièces

1742

Pince à riveter pour embouts filetés fournie avec 4 embouts (1x M3;M4;M5;M6)



1742 CHF 168.00 1 017420001

M	Ø mm	L mm
3	5	11
4	6	11
5	7	13
6	9	17

1742KR

Kit de 4 mandrins pour art. 1742



	CHF	1	017420043
M3	72.00	1	017420043
M4	72.00	1	017420044
M5	72.00	1	017420045
M6	72.00	1	017420046

1742R-AL/M...

Rivets filetés en aluminium pour 1742-1742A-1946KF



	CHF	1	017420023
1742R-AL M3 ØxL = 5x10 mm M = 3	6.25	1	017420023
1742R-AL M4 ØxL = 6x12 mm M = 4	6.40	1	017420024
1742R-AL M5 ØxL = 7x13 mm M = 5	6.90	1	017420025
1742R-AL M6 ØxL = 9x15 mm M = 6	8.35	1	017420026

Les prix indiqués sont pour 20 pièces

1742R-A/M...

Rivets filetés en acier pour 1742-1742A-1946KF



	CHF	1	017420013
1742R-A M3 ØxL = 5x11 mm M = 3	6.65	1	017420013
1742R-A M4 ØxL = 6x11 mm M = 4	6.75	1	017420014
1742R-A M5 ØxL = 7x13 mm M = 5	7.15	1	017420015
1742R-A M6 ØxL = 9x17 mm M = 6	8.55	1	017420016
1742R-A M8 ØxL = 11x17 mm M = 8	8.15	1	017420018
1742R-A M10 ØxL = 13x24 mm M = 10	9.75	1	017420020

Les prix indiqués sont pour 20 pièces
• Les prix indiqués sont pour 10 pièces

1742/C4

Pince à riveter 1742 avec composition de 400 embouts filetés en acier



1742/C4 CHF 377.00 1 017420005

	M	Ø mm	n.
1742R-A/M3	3	5	100
1742R-A/M4	4	6	100
1742R-A/M5	5	7	100
1742R-A/M6	6	9	100

415x155x60 mm - 2,9 kg

1742A

Pince à riveter gros effort pour embouts filetés fournie avec 4 embouts



1742A CHF 619.00 1 017420100

M	Ø mm	L mm
5	7	13
6	9	17
8	11	17
10	13	24

1742A/KR

Kit de 4 chevilles de rechange pour 1742A



		CHF		
1742A/KR M5	M5	49.00	1	017420143
1742A/KR M6	M6	49.00	1	017420144
1742A/KR M8	M8	49.00	1	017420145
1742A/KR M10	M10	49.00	1	017420146

1742A/C

Pince à riveter 1742A avec composition de 60 embouts filetés en acier



	CHF		
1742A/C	703.00	1	017420105

	M	∅ mm	n.
1742R-A/M5	5	7	20
1742R-A/M6	6	9	20
1742R-A/M8	8	11	10
1742R-A/M10	10	13	10

536x310x80 mm - 2,1 kg

1749

Pistolet à silicone modèle standard, tôle laquée



	L min mm	CHF		
1749	340	17.90	2	017490001

1749A

Pistolet à silicone modèle professionnel, tube en aluminium



	L min mm	CHF		
1749A	360	56.00	1	017490010

1749A/RB

Bec verseur pour 1749A

	CHF		
1749A/RB	1.29	1	017490051

1749A/RT

Bouchon frontal vissable pour 1749A

	CHF		
1749A/RT	2.83	1	017490052

1749AC

Pistolet à haute poussée pour scellants chimiques



	L min mm	CHF		
1749AC	360	49.50	1	017490005

1750

Pompe à graisse à levier

Utilisable avec cartouches 1750CG ou graisse en vrac



1 g, 550 bar Max

1750CG	cc	L mm	CHF		
400	500	380	55.00	1	017500500
600	750	450	65.00	1	017500750

1750R/1 - 1750R/2

Flexible pour 1750



	L mm	CHF		
1750R/1	310	8.75	2	017500030
1750R/2	410	9.75	2	017500040

1750RC

Bec rigide coudé pour 1750



	L mm	M mm	CHF		
1750RC	150	10x1	7.20	2	017500050

1750RT

Raccord à griffes pour 1750



	M mm	CHF		
1750RT	10x1	6.45	5	017500110

1750RP/1 - 1750RP/2

Raccord plat pour 1750



	∅ mm	M mm	CHF		
1750RP/1	16	10x1	15.90	2	017500115
1750RP/2	22	10x1	36.00	2	017500120

1750CG

Cartouche de graisse pour 1750



cc	CHF		
400	19.50	18	017500140
600	24.30	18	017500160

1750KG10

Pompe à graisse à levier de 10 kg, avec tuyau à haute pression de 2 m

Dotée d'un raccord pivotant pour ne pas étrangler le tuyau
Corps de pompage en aluminium moulé sous pression avec soupape de déchargement

3 niveaux différents de pression réglables :

- 4 g à 275 bars
- 7 g à 206 bars
- 9 g à 137 bars



312.5 mm

1750KG10 CHF 248.50 1 017500100

1750TA

Tête autobloquante à 6 broches pour graissage à haute pression

Une fois positionnée, elle reste sur le graisseur sans aucune aide.

Déconnexion facile même avec tête sous pression

Filet M10x1 : adapté à tous les types de pompe à graisse : électrique, pneumatique, manuelle etc.

Aucune déformation jusqu'à 550 bars



17 mm
30 mm

1750TA CHF 58.00 1 017500111

1750TLA

Tête autobloquante à 6 broches pour graissage, version longue

· Une fois positionnée, elle reste sur le graisseur sans aucune aide

· Déconnexion facile même avec tête sous pression

· Filet M10x1 : adapté à tous les types de pompe à graisse : électrique, pneumatique, manuelle etc.

· Aucune déformation jusqu'à 550 bars



17 mm
80 mm

1750TLA CHF 78.00 1 017500112

1750M

Mini pompe à graisse

- Avec micro-buse
- Particulièrement indiqué pour les outils pneumatiques



Ø 0,5 mm

Ø

	cc	D mm	L mm	CHF		
1750M	100	43	145	29.00	1	017500025

1750M3

Mini pistolet graisseur, avec 3 buses

- équipé de trois buses interchangeables: 0,7 - 1,0 - 1,4 mm
- particulièrement adapté à la lubrification des outils pneumatiques
- peut être utilisé avec de la graisse en vrac



Ø 0,7 mm

Ø 1,0 mm

Ø 1,4 mm

Ø

	cc	Ø mm	L mm	CHF		
1750M3	85	42	160	38.50	1	017500003

1751N

Burette tôle sous pression à embout flexible



	cc	D mm	L mm	CHF		
200	62	140	20.80	4	017510020	
300	75	140	22.60	4	017510030	
500	85	140	23.70	4	017510050	
750	100	140	26.00	2	017510075	
1000	100	140	28.00	2	017510100	

1751NR

Embout pour 1751N



	cc	D mm	L mm	CHF		
200÷1000			6.35	5	017510110	

1752

Burette plastique sous pression à embout rigide



	cc	D mm	L mm	CHF		
200	67	140	13.50	4	017520002	
300	77	140	14.60	4	017520003	
500	95	140	15.40	4	017520005	
700	95	140	16.30	2	017520007	

1752R

Embout pour 1752



	cc	CHF		
200÷700		5.50	5	017520020

1753

Burette plastique sous pression à embout flexible



	cc	D mm	L mm	CHF		
200	65	190	13.80	4	017530002	
300	80	190	14.10	4	017530003	
500	95	190	14.60	4	017530005	
700	95	190	16.00	2	017530007	

1753R

Flexible pour 1753



	cc	CHF		
200÷700		5.65	5	017530020

1754

Burette plastique à embout flexible



cc	D mm	L mm	CHF		
150	60	130	12.30	5	017540015
250	65	130	13.90	5	017540025

1755

Burette plastique à embout rétractable



cc	L mm	A mm	CHF		
30	160	30	9.05	5	017550003
80	170	47	10.10	5	017550008
150	230	58	11.30	5	017550015

1756

Burette stylo

Convient pour une utilisation avec des huiles minérales



cc	L mm	CHF		
5	140	29.50	2	017560001

1756B

Seringue à huile

- Avec rainurage antidérapant
- Température de fonctionnement : -10 °C ÷ +60 °C
- Densité d'huile minimale SAE 10



cc	L mm	CHF		
500	280	28.50	2	017560220

1756C

Seringue à huile de 200 ml en polypropylène

- Également adaptée au liquide du système de freinage
- Double joint en EPDM
- Température de fonctionnement : +0 °C ÷ +50 °C
- Non adaptée aux carburants et huiles minérales
- La densité d'huile minimale utilisable est ISO 150, SAE 90 (huile pour engrenages), SAE 40 (huile moteur)



1756C	CHF			
	44.50	1	017560502	

1756D

Seringue à huile de 1500 ml en polypropylène

- Double joint en NBR
- Température de fonctionnement : +0 - +50 °C
- NON adaptée aux carburants

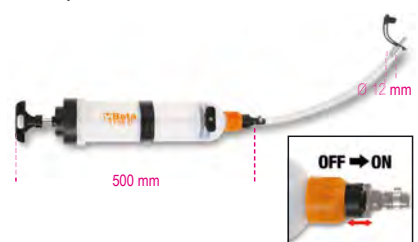

1756D	CHF			
	101.50	1	017560515	

1756G

Seringue pour moteurs diesel capacité 1,5 l pour branchement aux tuyaux diesel

- Utilisable pour :
- remplissage filtres diesel
 - remplissage réservoir cérine



- Le kit comprend :
- 2 tuyaux avec attache rapide femelle pour branchement tuyau diesel
 - 2 attaches rapides mâle en métal
 - 1 adaptateur conique pour tuyaux caoutchouc

1756G	CHF			
	156.00	1	017560615	

1756C-20R

Couple de joints toriques pour seringues 1756C

1756C-20R	CHF			
	5.75	1	017560503	

1756D-20R

Couple de joints toriques pour seringues 1756D

1756D-20R	CHF			
	9.60	1	017560516	

1757

Flacon de remplissage pour batterie



cc	D mm	CHF		
250	60	4.60	4	017570002
500	75	5.50	4	017570004
1000	90	7.65	2	017570006

1757A

Flacon avec bec verseur pour liquide de batterie



cc	CHF			
2000	56.50	1	017570020	

1758

Entonnoir auto-ajustable

Particulièrement utile pour les autos sans profondeur au niveau du bouchon de remplissage d'huile moteur



1758	CHF			
	70.00	1	017580020	

1758ADB-D

Entonnoir et anti-retour pour AdBlue



1758 ADB-D	l	Max	CHF		
	1		45.00	1	017580050

1758ADB-45°

Entonnoir avec accouplement à 45° et anti-retour pour AdBlue®



1758 ADB-45° ^IMax 1 CHF 48.50 1 017580060

1758A

Entonnoir anti-retour avec attache rapide Ø 38 mm
Pour automobiles du groupe Volkswagen



1758A CHF 108.00 1 017580010

1758B

Entonnoir anti-retour avec attache rapide
Particulièrement indiqué pour les automobiles du groupe VAG



1758B CHF 47.00 1 017580030

1758B-1,6

Entonnoir anti-retour de 1600 ml avec attache rapide
Attache rapide pour les automobiles de groupe VAG



H1 H2 Ø CHF 1758B-1,6 125 100 155 52.50 1 017580033

1758B-RNT

Coupleur rapide anti-reflux pour entonnoir 1758B - 1758B-1,6

Pour moteur Renault 1,5 dCi



1758B-RNT CHF 33.50 1 017580035

1758B/K5

kit d'adaptateurs d'accouplement rapide sans retour, pour entonnoir 1758B - 1758B-1,6

Contenu du kit :

- 1 adaptateur pour moteurs Renault, Dacia, Nissan 1,5 dCi
- 1 adaptateur pour moteurs Renault, Dacia, Nissan 1.5/1.6 dCi
- 1 adaptateur pour moteurs diesel BMW 3.0
- 1 adaptateur pour moteurs essence 1.5/2.0, groupe VAG
- 1 adaptateur de connexion pour entonnoir, avec robinet



1758B/K5 CHF 134.00 1 017580040

1758LG

Plaque modulaire en aluminium revêtue de caoutchouc, pour la canalisation des liquides



L mm H mm CHF 1758LG 365 168 60.00 1 017580006

1758M

Entonnoir



1758M L mm CHF 1758M 350 17.60 1 017580000

1758R

Récipient pour liquides

Bec flexible pratique extractible



1758R	lit	CHF		
1758R 1	1	11.00	1	017580201
1758R 2	2	13.30	1	017580202
1758R 3	3	23.60	1	017580203
1758R 5	5	28.50	1	017580205

1758VT

Kit pour le contrôle des têtes

Signale rapidement l'éventuelle présence d'anhydride de carbone dans la cuve d'expansion



1758VT CHF 227.50 1 017580100

290x190x50 mm - 1 kg

1758VT/L

Liquide de contraste pour le contrôle des têtes



1758VT/L CHF 65.00 1 017580101

1759

Analyseur optique pour liquides de refroidissement, batterie, lave-vitres et AdBlue®

En étui rigide

Compensation automatique de la température

Acide batterie : intervalle de mesure

de 1,1 à 1,3 kg/l

Liquide de refroidissement propylène :

de -25 °C à -50 °C

Liquide de refroidissement éthylène : de -25 °C à -50 °C

Liquide lave-vitres : de -25 °C à -40 °C

AdBlue : Mesure d'urée en pourcentage de 30% à 45%



1759 CHF 211.00 1 017590251

1759A

Pèse-antigel

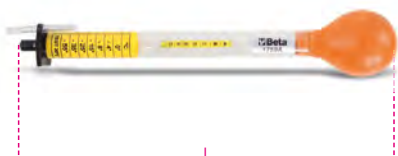

1759A CHF 88.50 1 017590001

1759B

Pèse-acides



1759B CHF 58.00 1 017590005

1759HD/3

Outil pour le contrôle de l'étanchéité de l'installation de refroidissement et remplissage du circuit (outil de contrôle d'étanchéité et de remplissage du circuit de refroidissement)

• Permet de vérifier sous pression les pertes de charge (tuyaux, raccords, pompes, radiateurs) et de remplir rapidement le circuit afin d'éviter la formation de bulles d'air



1759HD/3 CHF 743.00 1 017590063
≡ 600x500x140 mm - 📦 6,5 kg

1759HD/RR

Outil pour remplissage du circuit de refroidissement



1759HD/RR CHF 227.50 1 017590064
≡ 450x310x110 mm - 📦 2,2 kg

1759LR

Outil de lavage des systèmes de refroidissement

grâce à l'air comprimé, le système de haute pression de l'eau permet un lavage efficace du système de refroidissement

- 6 adaptateurs pour connexion avec installation
- Levier de commande avec verrouillage de position pour une utilisation continue
- Raccord rapide eau inclus



1759LR CHF 570.00 1 017590070
≡ 390X330X100

1759HD/TRUCK

Coffret de testeur de pression de liquide de refroidissement des poids-lourds



1759HD/TRUCK CHF 517.00 1 017590065
≡ 440x330x100 mm - 📦 3 kg

1759TT

Kit de 4 paires de bouchons pour le contrôle des circuits turbo - utilisable avec pistolet de gonflage de pneus



1759TT CHF 274.00 1 017590300
≡ 400x160x100 mm - 📦 1,8 kg

CERTIFICATION D'INSTRUMENTS DE MESURE ÉLECTRONIQUES

La certification d'instruments de mesure électronique tels que les multimètres, les pinces ampèremétriques, les **tachymètres** et les **thermomètres** sont essentiels dans les secteurs où les domaines d'application requièrent des mesures précises et non ambiguës.

Pour les thermomètres infrarouges, un rapport d'étalonnage en 4 points (minimum, maximum et deux points intermédiaires) avec traçabilité ENAC est délivré.

Sur demande, Beta Utensili S.p.A. fournit le service de certification. Pour bénéficier de ce service, veuillez contacter votre revendeur.

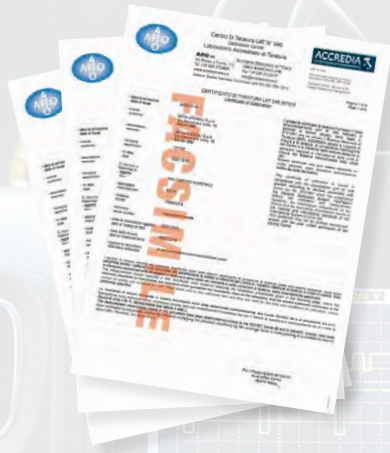

1760DGT

Multimètre numérique automobile



CARACTÉRISTIQUES TECHNIQUES

RPM (tachymètre):
 Pour moteurs à 2 et 4 cylindres
 RPM4 600 - 4000 RPM
 RPM4 600 - 12000 RPM (x10 RPM)
 RPM2/DIS 300 - 4000 RPM
 RPM2/DIS 300 - 6000 RPM (x10 RPM)
 Angle Dwell: 4-8 CYL
 Tension c.c. : 400mV-4/40/400/1000V
 Tension a.c. : 4/40/400/700V
 Courant c.c. : 40/400mA-4/20A
 Courant a.c. : 40/400mA-4/20A
 Résistance : 400Ω-4/40/400kΩ-4/40MΩ
 Capacité : 40/400nF-4/40/100μF
 Fréquence : 5/50/500Hz-50/500-10MHz
 Duty Cycle: 0.1 - 99,9%
 Amplitude pulsations : 1 - 10ms
 Essai diodes : courant test 0,3mA
 Continuité : <150Ω - courant test <0,3mA
 Display : LCD à contraste élevé 4 digits, rétroéclairé
 Surtension : catégorie II 1000 V
 Auto-extinction : 30 minutes
 Alimentation : 1 pile 9V (fournie)
 Pince inductive (fournie)
 2 embouts (fournis)
 Étui souple en toile (fournie)
 Manuel d'utilisation

1760DGT

CHF
348.00

1 017600005

1760DGT/2

Multimètre numérique automobile portable avec oscilloscope à 2 canaux et générateur d'onde



LE KIT COMPREND :

- embouts multimètre
- 2 connecteurs pince crocodile BNC pour oscilloscope
- sonde à embout pour oscilloscope (1X et 10X)
- chargeur de batterie
- étui en nylon

DONNÉES TECHNIQUES

Écran : TFT en couleurs de 2,8"
 Résolution : 320 x 240 pixels
 Alimentation : 100V-240V AC, 50Hz-60Hz ; DC INPUT 5V DC-2A
 Batterie : 2 x 2600 mAh

SPÉCIFICATIONS MULTIMÈTRE

Test : Tension, Courant, Résistance, Capacité, Diodes et On-Off
 Tension max. : 600V AC-DC
 Courant max. : 10A AC-DC
 Résistance max. : 40MOHM
 Capacité max. : 100μF

SPÉCIFICATIONS OSCILLOSCOPE

Horizontale
 Largeur bande : 40MHz
 Intervalle de fréquence échantillon : 250MSa/s (canal simple) - 125MSa/s (double canal)
 Gamme SEC/DIV : 5ns/div ÷ 500s/div 1,2,5 séquence
 Verticale
 Gamme VOLTS/DIV : 10mV/div÷10V/divat entrée BNC
 Analogique sélectionnable limite largeur de bande, typique : 20MHz
 Réponse à basse fréquence (-3db) : ≤10Hz à BNC
 DC Précision: ± 3% pour la modalité d'acquisition Normale ou Moyenne, de 10V/div à 10 mV/div
 Trigger
 Type : Edge
 Mode : Auto, Normal, Single
 Slope : Rising, Falling, Rising, & Falling
 Source : CH1, CH2
 Entrée
 Accouplement : DC, AC ou GND
 Facteurs d'alimentation de la sonde supportés : 1X, 10X, 100X, 1000X
 Générateur de forme d'onde arbitraire
 Fréquence forme d'onde : Sine (1Hz÷25MHz), Square (1Hz÷10MHz), Ramp (1Hz÷1MHz), EXP (1Hz÷5MHz)
 Ampleur : 2,5Vpp (50Ω) - 5Vpp (haute impédance)
 Impédance de sortie : 50Ω

Dimensions : 199 x 98 x 40 mm
 Poids : 624 g

1760DGT/2

CHF
971.00

1 017600008

1760B

Multimètre digital



SPÉCIFICATIONS

Tension CC : 200 mV-2/20/200/1000V
 Tension CA : 2-20/200/700V
 Courant CC : 2/20/200 mA-20 A
 Courant CA : 2/200 mA- 20 A
 Résistance : 200Ω - 2/20/200 kΩ - 2/20 MΩ
 Capacité : 2/20/200 nF - 2/200 μF
 Température : -20° + 1000°C/ -4 °F ~ +2000°F
 Fréquence : 20kHz
 Alimentation : 1 pile 9 V (fournie)

1760B CHF 225.00 1 017600012

1760/OHM

Multimètre/mégohmmètre pour test isolation à haute tension.

Lecture à valeur efficace TRUE RMS



CE
 CAT. IV
 600V
 CAT. III
 1000V

Plage de mesure	Précision de base	
Tension AC/DC : 50mV - 1000V	±0.06% - ±0.1% rdg	
Courant AC/DC : 0.01μA - 10A	±0.5% - ±1% rdg	
Résistance : 0.01Ω - 50MΩ	±0.2% - ±2% rdg	
Meg OHM : 0.01 - 5000MΩ	±4% rdg. max current	
1mA		
Capacité : 5nF - 10mF	±1.5% - ±3% rdg	
Fréquence : 50Hz - 100 MHz	±0.02% - ±0.1% rdg	
Température : -50°C - +1350°C	±0.5% rdg	
Test diodes : $3 V_{cc}$		
Test continuité : <math><30 \Omega</math>		

1760/OHM CHF 1,065.00 1 017600025

1760/RMS

Multimètre industriel IP67

avec lecture en valeur efficace RMS

EN61010-1
 EN61326-1



Plage de mesure	Précision de base
Tension CA/CC	110mV - 600V ±0.8% - ±2% rdg
Courant CA/CC	110μA - 10A ±1.5% - ±2% rdg
Résistance	110Ω - 40MΩ ±1.2% - ±2.5% rdg
Capacité	11nF - 40mF ±5% - ±10% rdg (jusqu'à 11mF)
Fréquence	1100Hz - 110 MHz ±1.2% - ±1.5% rdg
Température	-32°C - +1000°C ±3% - ±5% rdg
Test diodes	3 Vcc ±10% rdg
Test continuité	<math><30 \Omega</math>

1760/RMS CHF 384.00 1 017600020

1760S

Multimètre digital compact

Lecture à valeur efficace TRUE RMS



Spécifications :

Tension CC : 200 mV-2/20/200/600V
 Tension CA : 100/600V
 Courant CC : 200 mA-10 A
 Courant CA : 0,01-10 A
 Résistance : 200Ω - 2/20/200 kΩ - 2 MΩ
 Essai diodes : 0.4 ÷ 0.7
 Alimentation : 2 piles 1,5V type AAA

1760S CHF 110.50 1 017600022

153x75x42 mm

1760PA/80

Pince ampèremétrique AC/DC 80A

Spécifique pour les mesures de valeurs basses de dispersion du courant ou absorptions sur véhicules



- Fourchette : 1mA-80AAC/DC
- Fonction torche avec LED blanc
- Écran d'affichage LCD illuminé sur le fond
- Fonction de mise à zéro
- Fonction Hold
- Extinction automatique
- Alimentation : 2 piles 1,5V type AAA

1760PA/80 CHF 290.00 1 017600002

1760PA/AC

Pince ampèremétrique et multimètre digital

A: AC
 V: AC/DC



SPÉCIFICATIONS

Tension CC 400 mV - 4/40/400/600 V
 Tension CA 400 mV - 4/40/400/600 V
 Courant CA 40/400/1000 A
 Résistance 400Ω - 4/40/400 kΩ - 4/40 MΩ
 Fréquence 5/50/500 Hz - 5/50/500 kHz - 5/10 MHz
 Capacité 40/400 nF - 4/40/100 μF
 Température -20 °C ÷ 1000 °C / -4 °F ÷ 1832 °F
 Alimentation : 1 pile 9 V (fournie)

1760PA/AC CHF 235.50 1 017600050

1760PA/AC-DC

Pince ampèremétrique et multimètre digital

A: AC/DC
V: AC/DC

CE



A: AC/DC
V: AC/DC

SPÉCIFICATIONS

Tension CC: 0.1mV ÷ 600V
Tension CA: 0.1mV ÷ 600V
Courant AC: 0.01A ÷ 1000A
Courant CC: 0.01A ÷ 1000A
Résistance: 0.1Ω ÷ 40MΩ
Capacité: 0.001nF ÷ 40 μF
Fréquence: 0.001kHz ÷ 4kHz
Température: -40°C ÷ 1000 °C
-40°F ÷ 1832°F

1760PA/AC-DC CHF 430.00 1 017600000

1760PA/AC-DC2000

Pince ampèremétrique avec multimètre numérique

munie d'une connexion Bluetooth

Fonction TRUE RMS dans les mesures AC

A: AC/DC
V: AC/DC

CE



Spécifications :

• Tension CC: 0.1mV ÷ 1000V
• Tension CA: 0.1mV ÷ 1000V
• Courant CA: 0.01A ÷ 2000A
• Courant CC: 0.01A ÷ 2000A
• Résistance: 0.1Ω ÷ 60MΩ
• Capacité: 1nF ÷ 6000 μF
• Fréquence: 10kHz ÷ 20kHz
• Température: -20 °C ÷ 1000 °C -4 °F ÷ 1832 °F
• Alimentation: 3 piles 1,5V type AA (fournies)
• Connexion Bluetooth (version 4.0)

H mm 300 L mm 110 P mm 43 CHF 848.00 1 017600003

380x280x100 mm - 1,78 kg

1760DGT-R3

Embout pour multimètres numériques et pinces ampèrométriques



1760DGT-R3 CHF 30.00 1 017600603

1760/RSE

Détecteur de signal

Permet de tester l'alimentation de composants tels que : injecteurs électroniques Common Rail, injecteurs électroniques essence/ GPL, injecteurs piézoélectriques, électrovannes débitmètre EGR, bobines et autres



Pour effectuer le diagnostic individuel des composants de l'installation électrique, il suffit d'approcher la sonde du composant en question.
Sur les installations avec composants électromécaniques/ électroniques commandés par une centrale, l'instrument permet de vérifier si :
- la centrale de gestion est alimentée et remplit sa fonction de commande
- le câblage de la centrale au composant est efficace
- le composant en question n'est pas interrompu
- le composant n'est pas en court-circuit
- le composant fonctionne d'un point de vue électronique

1760/RSE CHF 603.00 1 017600170

Beta

1760/TC2

Tachymètre digital à distance et par contact



CARACTÉRISTIQUES TECHNIQUES

- Pour la mesure de :
 - rotation à distance (tr/mn - rpm)
 - rotation (tr/mn - rpm) et vitesse linéaire (m/mn ou ft/min) par contact.
- Afficheur à cristaux liquides à 5 chiffres.
- Échelle :
 - à distance 2,5÷99.999 tr/mn
 - par contact 0,5÷19.999 tr/mn
 - vitesse linéaire 0,05÷1.999,9 m/mn.
- Fréquence : 0,8 sec.
- Alimentation : 4 piles de 1,5V (type AA) ou alimentateur 6V (pas fourni)
- Fourni avec :
 - adaptateur pour les mesures par contact;
 - 2 embouts mâles en caoutchouc;
 - 1 embout femelle en caoutchouc;
 - 1 molette pour détections linéaires;
 - étiquettes réfléchissantes;
 - manuel d'instructions;
 - boîtier en plastique.

1760/TC2 L mm 230 H mm 74 CHF 301.00 1 017600161

1760R/TC2

Jeu d'étiquettes réfléchissantes pour 1760/TC2



1760R/TC2 CHF 26.50 1 017600561

1760K

Détecteur de tension de poche avec mini-torche à LED

Plage de détection : 200-1000Vac 50/60Hz
CAT III-1000V
Alimentation : 2 piles AAA (comprises)



1760K CHF 47.50 1 017600140

1760PT

Testeur combiné de tension et de continuité
12-690V AC/DC

Fonctions :

- continuité
- rotation phases
- détecteur de tension
- torche LED

CE



IP64
CATIV
- 600V ;
CATIII -
1000V

1760PT CHF 193.00 1 017600150

1760/IR500

Thermomètre digital à infrarouge avec
système de pointage laser double

ne convient pas pour mesurer la température corporelle

CE



CARACTÉRISTIQUES TECHNIQUES

Gamme de température : -50 + 500 °C (-22 + 932 °F)
Résolution afficheur : 0,1 °C (0,1 °F)
Émissivité : 0,1 + 1 réglable
Précision : -50 + 20 °C (+/- 3 °C); 20 + 500 °C (+/- 2 % ou 2 °C)
Résolution optique (D:S) : 12:1
Auto-extinction : environ 10 secondes
Température d'exercice : 0 + 50 °C
Température de stockage : -20 + 60 °C
Alimentation : 1 pile 9V

1760/IR500 CHF 207.00 1 017600350

1760/IR1000

Thermomètre digital à infrarouge avec
système de pointage laser double

ne convient pas pour mesurer la température corporelle

CE



CARACTÉRISTIQUES TECHNIQUES

Gamme de température : -50 + 1000 °C (-58 + 1832 °F)
Résolution afficheur : 0,1 °C (0,1 °F)
Émissivité : 0,1 + 1 réglable
Précision : -50 + 20 °C (+/- 3,5 °C); 20 + 300 °C (+/- 1% ou 1 °C);
300 + 1000 °C (+/- 1,5 %)
Résolution optique (D:S) : 20:1
Température d'exercice : 0 + 50 °C
Température de stockage : -10 + 60 °C
Alimentation : 2 piles 1,5 V (type AAA)

1760/IR1000 CHF 342.00 1 017600400

1760/IR1600

Thermomètre digital à infrarouge
avec système de pointage laser

ne convient pas pour mesurer la température corporelle

CE



CARACTÉRISTIQUES TECHNIQUES

Gamme: -50 °C + 1600 °C / -58 °F + 2912 °F
Sélection échelle: °C/°F
Précision: ±1,5% ou ±2 °C + 20 °C
Puissance Laser: <1mW
Réponse: 1 sec
Émissivité: 0,10+1,0 réglable
Rapport distance: (D:S) 50:1
Température d'exercice: 0 °C + 50 °C / 32 °F + 122 °F
Taux d'humidité: de 10% à 90% RH
Afficheur LCD rétroéclairé
Fonction de maintien des données
Auto-extinction
Alimentation: 1 pile 9V (fournie)
Boîtier rigide trépieds en aluminium
Manuel d'utilisation

1760/IR1600 mm 200 mm 115 CHF 956.00 1 017600461

1760LX

Luxmètre numérique portable

EN61010-1
EN61326-1

CE



Détails techniques :

Plage de mesure Précision de base
Luminosité Lux 0-200000 ±3%
Luminosité FC 0-20000 ±3%
Alimentation : 1 x 9V

1760LX L mm CHF 130.00 1 017600820

1760TMC

Caméra thermique à infrarouges

Caméra thermique compacte pour la mesure
de la température sans contact, préconisée
pour applications dans les secteurs du
bâtiment, de la mécanique, les installations
électriques et de chauffage.

Écran d'affichage LCD TFT de 2 pouces 240x320
Capteur de 32x32 pixels
Fréquence d'acquisition 7Hz
Thermosensibilité <347mK
Acquisition automatique des points chauds et froids
Appareil photo d'acquisition d'images en format BMP (maximum
100 images)
Émissivité réglable
Alimentation 3 batteries alcaline AAA
Interface USB
IP54
Température -20°C/+600 °C
Bande infrarouges 6,5+14µm
Distance de fusion visible/infrarouge : 0,5 ; 1 ; 2 m
Fonction alarme, en sélectionnant la température maximale et
minimale acceptables

CE



1760TMC 600 CHF 1,089.00 1 017600710



1760WM

Anémomètre numérique avec capteur à pales de ventilateur

EN61010-1
EN61326-1



Détails techniques :
Plage de mesure Précision de base
Vitesse m/s 0,4-30 ±2%
Vitesse k/n 1,4-108 ±2%
Vitesse ft/m 80-5900 ±2%
Vitesse mil/h 0,8-58 ±2%
Flux CFM 0-99990 ±0-9,999 ft2
Flux CMM 0-99990 ±0-9,999 m2
Flux CMS 0-99990 ±0-9,999 m2

L mm CHF 170 105.50 1 017600800

1761

Pince tordeuse de fil à retour automatique



L mm CHF 255 84.50 1 017610101

1761RS/1

Pince tordeuse de fil réversible à retour automatique



L mm CHF 220 150.50 1 017610130

1762

Pince emporte-pièces 6 diamètres



Ø mm L mm CHF 2-2,5-3 3,5-4-4,5 210 39.50 2 017620001

1763

Pince pour selliers automobiles



CHF 1763 46.50 1 017630001

1763G/S500

500 agrafes pour revêtements textiles auto



CHF 1763G/S500 87.50 1 017630105

1764/K5

Pince à riveter manuelle pour rivets en plastique

Fournie avec 4 tailles de rivets

Le kit comprend :

- 10 rivets Ø 5x17,2 mm
- 10 rivets Ø 5x15,8 mm
- 10 rivets Ø 6,3x25,2 mm
- 10 rivets Ø 6,6x17,2 mm



CHF 1764/K5 67.50 1 017640001

1765/C24

Coffret avec 24 outils dépose-autoradios



CHF 1765/C24 257.00 1 017650001

1766

Ventouse double pour pare-brise



CHF 1766 max 50 kg 157.50 2 017660001

1766A

Ventouse simple



CHF 1766A max 30 kg 40.50 2 017660005

1766/8

Composition de 8 outils pour vitres automobile



CHF 1766/8 587.00 1 017660100

1766ER

Extracteur pour lèche-vitres avec manche

Permet d'extraire aisément les lèche-vitres sans risquer de les abîmer



1766ER CHF 28.50 1 017660501

1766ER/VW

Outil de retrait de garniture de fenêtre

Particulièrement adapté aux moulures de fenêtres du groupe VAG avec un espace de préhension réduit

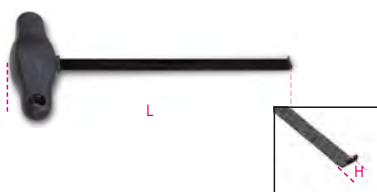

L mm 215 H mm 4 CHF 20.30 1 017660510

1766L

Lève pare-brise



1766L CHF 65.50 1 017660015

1766LI

Lever pour insertion câble coupe vitres

bords aiguisés pour coupe scellant



1766LI CHF 23.40 1 017660016

1766I

Poignée pour câble 1766G



1766I CHF 64.00 2 017660020

1766G

Câble d'acier pour vitres

Section carrée



50 m CHF 57.00 1 017660025

1766T

Câble carré en acier pour pare-brise

section triangulaire



50 m CHF 65.50 1 017660026

1767A

Barre télescopique

- Conçue pour soutenir les capots et les coffres dont les verrous ne fonctionnent plus
- Également utilisable pour maintenir les pédales bloquées



L mm 640 ÷ 1090 CHF 89.00 1 017670000

1767B

Kit pour le verrouillage de la pédale de frein et du volant

Le mécanisme de réglage par gâchette garantit des réglages précis tout en gardant le véhicule accéléré



1767B CHF 191.00 1 017670100

490x285x95 mm - 2,4 kg

1767PMC

Bac de rangement magnétique rond



1767PMC CHF 28.00 1 017670020

1767PMR

Bac de rangement magnétique rectangulaire



1767PMR CHF 57.00 1 017670010

1768

Marche pied en aluminium

Surface revêtue d'un matériau antidérapant
capacité de charge maximale: 200 kg



L mm 960 L1 mm 300 H mm 475 CHF 246.00 1 017680010

1770

Cutter extra-plat à lame sécable 9 mm avec 2 lames de rechange



1770 L mm 140 A mm 9 CHF 21.70 10 017700001

1770A

Cutter de 9 mm avec blocage automatique de la lame, avec 3 lames de rechange



1770A L mm 135 A mm 9 CHF 8.15 5 017700025

1770RL

Étui de 10 lames sécables 9 mm, pour 1770, 1770BM et 1770A



1770RL CHF 7.20 5 017700010

1770BM

Cutter de 9 mm, avec 6 lames de rechange



1770BM L mm 140 A mm 9 CHF 16.60 10 017700050

1771

Cutter à lame sécable 18 mm avec 3 lames



1771 CHF 12.30 10 017710000

1771BM

Cutter à lame sécable 18 mm, avec 6 lames à rechargement automatique



1771BM L mm 170 A mm 18 CHF 27.00 10 017710050

1771HD

Cutter 18 mm fourni avec 6 lames

- Chargement automatique de la lame
- Système bloque-lame à vis



1771HD L mm 190 A mm 18 CHF 30.00 5 017710100

1771RL

Étui de 10 lames sécables 18 mm, pour 1771 et 1771BM, 1771HD



1771RL CHF 10.40 5 017710010

1772M

Cutter de sécurité à lame rétractable, avec 4 lames

- Lame avec retour automatique à ressort
- Corps en alliage moulé sous pression
- Retire-agrafes intégré dans le manche



1772M L mm 170 A mm 18 CHF 24.60 5 017720040

1772R

Cutter à lame trapézoïdale rétractable fourni avec 5 lames



1772R L mm 125 A mm 18 CHF 22.70 5 017720006

1772H

Cutter de sécurité à lame rétractable, avec 2 lames



1772H L mm 170 A mm 18 CHF 23.90 5 017720029

1772RL/2

Étui de sécurité de 10 lames trapézoïdales longues pour 1772H, 1772M, 1772R, 1774, 1777BMT, 1777T

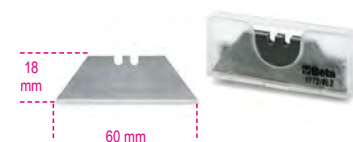

1772RL/2 CHF 5.75 5 017720017

1773A

Cutter de 25 mm



1773A L mm 180 A mm 25 CHF 23.90 10 017730000

1773RL

Étui de 10 lames pour 1773A



1773RL CHF 23.40 5 017730015

1774

Grattoir plastique avec protection de la lame



1774 L mm 155 L1 mm 60 CHF 5.50 5 017740001

1774A

Grattoir plastique poignée bi-matières



1774A L mm 300 A mm 40 CHF 17.10 1 017740011

1774A/RL

Étui de 10 lames pour grattoirs 1774A et 1774S

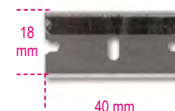

1774A/RL CHF 8.15 1 017740511

1774S

Grattoir pour enlever les adhésifs



1774S A mm 40 L mm 100 CHF 9.25 2 017740021

1777BM

Couteau d'électricien avec dénudeur, lame en acier inoxydable



	L	L1	A			
	mm	mm	mm			
1777BM	190	80	16	CHF	5	017770100
				15.60		

1777T

Couteau à cran d'arrêt avec lame trapézoïdale, poignée en aluminium fournie avec 5 lames de rechange



	L	A	L1			
	mm	mm	mm			
1777T	160	19	65	CHF	5	017770030
				34.00		

1777BMT

Cutter à lame trapézoïdale à cran d'arrêt avec 3 lames
4 profondeurs réglables de la lame
4; 9.5; 15.5; 21.5 mm
fourni avec 3 lames



	L	L1	A			
	mm	mm	mm			
1777BMT	170	80	19	CHF	5	017770050
				36.50		

1778AN

couteau pliant, lame en acier inoxydable, poignée légère en aluminium anodisé
• avec étui



	L	A	L1			
	mm	mm	mm			
1778AN	204	26	84	CHF	5	017780065
				42.00		

1778AX

Couteau à cran d'arrêt, lame en acier inoxydable à dents, manche en aluminium, avec cran pour ouverture aisée,
• avec étui



	L	A	L1			
	mm	mm	mm			
1778AX	189	26	80	CHF	5	017780026
				46.00		

1778CM

Couteau à cran d'arrêt mimétique lame en acier trempé en étui



	L	A	L1			
	mm	mm	mm			
1778CM	195	24	80	CHF	5	017780099
				43.50		

1778M7

couteau pliant, mini lame en acier inoxydable, poignée avec inserts en fibre de verre
• avec étui



	L	A	L1			
	mm	mm	mm			
1778M7	163	24	68	CHF	5	017780015
				37.00		

1778P

couteau à cran d'arrêt, lame et manche en acier inoxydable et aluminium, bouton d'ouverture
• avec étui



	L	A	L1			
	mm	mm	mm			
1778P	193	29	72	CHF	5	017780088
				49.50		

1778SCL

Couteau à cran d'arrêt avec finition soft carbon look
lame en acier trempé
avec étui



	L	A	L1			
	mm	mm	mm			
1778SCL	180	22	78	CHF	5	017780089
				41.00		

1778SOS

Couteau de survie auto avec fonction marteau brise-vitre et coupe-ceinture de sécurité avec étui



	L	A	L1			
	mm	mm	mm			
1778SOS	205	25	85	CHF	5	017780080
				43.50		

1778V18

Couteau à cran d'arrêt en aluminium
• avec étui



	L	A	L1			
	mm	mm	mm			
1778V18	195	25	85	CHF	5	017780018
				41.00		

1778X

Couteau pour maintenance nautique en acier inoxydable avec manche aluminium



	L	L1	A			
	mm	mm	mm			
1778X	185	85	25	CHF	2	017780050
				39.50		

MULTITOOL -

L'outil multifonctions BETA se distingue des articles similaires sur le marché par des caractéristiques qui dénotent son origine BETA : des pinces d'une qualité incomparable, l'utilisation de matériaux prisés et un haut contenu technologique. La présence de **11 embouts** aux géométries les plus présentes sur le marché, rend cet article idéal pour tout milieu et toute condition de travail, du camping au nautisme, de la chasse au bricolage.



22 FONCTIONS

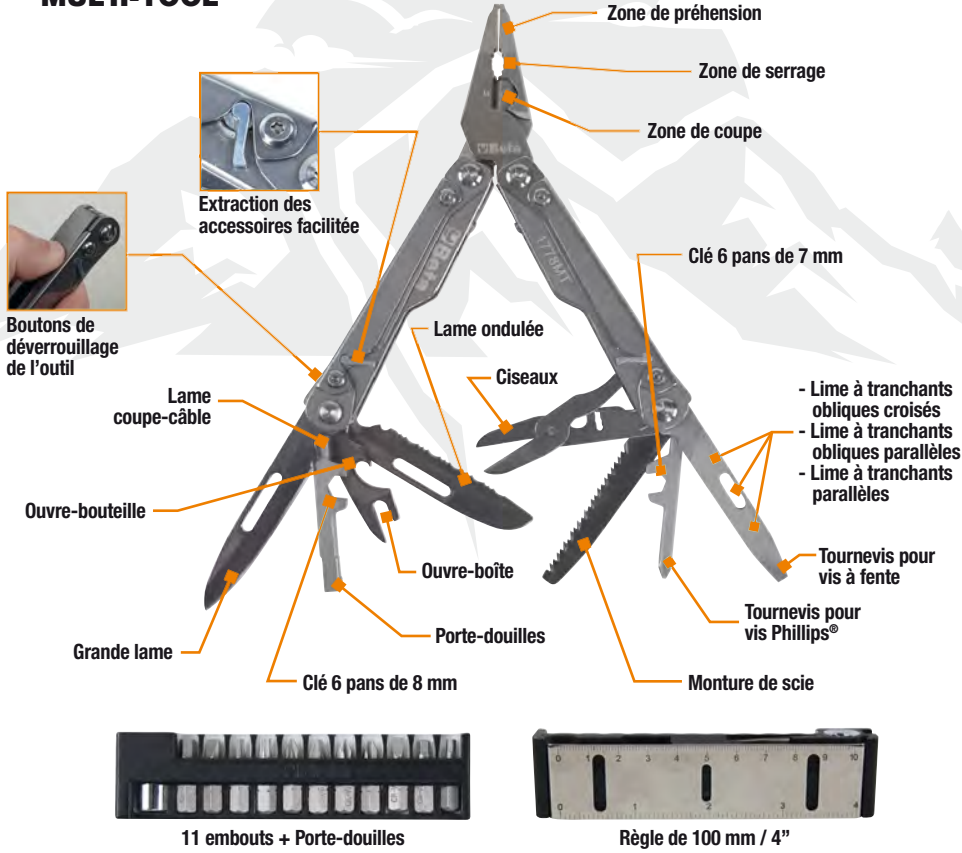

11 embouts + Porte-douilles



Règle de 100 mm / 4"

1784

Ciseaux gros effort



L mm	CHF	🔧	📦
175	28.50	2	017840017
200	38.50	2	017840020
250	51.00	2	017840025
300	69.00	2	017840030

1800/100

Coussin élévateur (max. 100 kg)

- Soulever-mettre à niveau
- Bloquer portes et volets



A mm	B mm	S mm	CHF	🔧	📦
160	150	2+55	76.00	3	018000000

1778MT

Outil multifonctions complet avec embouts et étui
9 outils
22 fonctions



L mm	L1 mm	CHF	🔧	📦
180	115	130.00	1	017780055

1781

Ciseaux à lames longues pointues



L mm	CHF	🔧	📦
1781 132	24.10	2	017810001

1783

Ciseaux faible effort



L mm	CHF	🔧	📦
215	20.00	5	017830021
240	22.30	5	017830024



ÉCLAIRAGE

La famille d'éclairage comprend une large gamme de produits conçus pour satisfaire toutes les exigences des utilisateurs, allant de l'inspection de petits tuyaux à l'éclairage de grandes zones de travail.

Lampes de poche

Le nouveau design, les améliorations techniques et le large choix de tailles permettent de sélectionner la lampe de poche la plus appropriée en fonction des critères de : luminosité, durée de vie de la batterie et des performances.

Lampes et spots

Basées sur une technologie LED améliorée, une durée de vie allongée de la batterie, un temps de charge réduit, une attention particulière aux matériaux et une recherche continue de solutions innovantes, les lampes de travail de Beta allient une combinaison exceptionnelle de design, fonctionnalité et performance. Une gamme complète conçue pour permettre aux professionnels de travailler dans tous les secteurs d'activité et dans les meilleures conditions possibles.



WIRELESS

La nouvelle technologie sans fil permet de charger les derniers spots et lampes via une seule base de charge 1839BRW. Grâce à la nouvelle base 1839BRW, il est possible de

charger simultanément les spots et les lampes les plus récents (symbole wireless pag. 12 Autopromotec) sans nécessairement avoir recours à des câbles. De plus, le support amovible permet également de recharger les téléphones portables.



CRI - Color Rendering Index

CCT - Correlated Color Temperature

PROJECTEURS							
ARTICLE	LUMEN	BATTERIE	TEMPS DE RECHARGE	AUTONOMIE	IP/IK	CCT	CRI
1837C/2100	500 - 1000 - 2100	Li-Ion 11.1V; 4400 mAh	4.0h	9 - 2.5h	IP65 - IK07	6500K	80+
1837C/4300	1100 - 2100 - 4300	Li-Ion 11.1V; 5200 mAh	4.0h	6 - 1.5h	IP65 - IK07	6500K	80+
1837M	500 - 1000 - 2000	Li-Ion 11.1 V; 5200 mAh	3.5h	2 - 8h	IP65 - IK07	2700-3500-4500-5500-6500K	96+
1838FLASH	360 - 720	Li-Ion 7.4 V; 4000 mAh	4.0h	4 - 8h	IP65	6300K	-
1838POCKET	160 - 400 - 800	Li-Ion 3.7 V; 2600 mAh	4.0h	3 - 9h	IP65	6500K	80+

LES LAMPES							
ARTICLE	LUMEN	BATTERIE	TEMPS DE RECHARGE	AUTONOMIE	IP/IK	CCT	CRI
1838/11LED	320	Li-Ion 3.7V; 4200 mAh	4.0h	4h	IP65	6500K	
1838AM	60 - 700 120 (spot)	Li-Ion 3.7V; 2600 mAh	4.0h - USB-C	2.5 - 16h 10h (spot)	IP54 - IK07	6500K	80+ 70+
1838COB	100 - 200 75 (spot)	Li-Ion 3.7V; 1600 mAh	3.0h	3-6h 4h (spot)	IP65	6000K	80+
1838P	80 - 50	Li-Ion 3.7V; 700 mAh	2.5h	4h	IP20	6000K	80+
1838SLIM	100 - 200 180 (back) 80 (spot)	Li-Ion 3.7 V; 700 mAh	2.5h - USB-C	2 - 4h 2h (back) 3h (spot)	IP54 - IK07	6500K	80
1838UV	75 - 150	Li-Ion 3.7V; 1600 mAh	3.0h	3h	IP20	6000K	80
1838SW	250 - 500 - 1000	Li-Ion 3.6V; 3350 mAh	4.5 - 6.5h	3 - 7h	IP65 - IK07	6500K	80+
1838E	500 - 1000 - 2000	Li-Ion 3.6V; 3350 mAh	4.5 - 6.5h	3 - 9h	IP20 - IK07	5500K	80+

LAMPES FRONTALES							
ARTICLE	LUMEN	BATTERIE	TEMPS DE RECHARGE	AUTONOMIE	IP/IK	CCT	CRI
1836B	125 - 250	Li-Ion 3.8V; 1600 mAh	3.0h	5h	IP65 - IK07	6000K	80+
1836AW	30 - 200 - 400	Li-Ion 3.7V; 1500 mAh	2.5h	4-18h	IP65 - IK07	6500K	80+

LUMIÈRES						
ARTICLE	LUMEN	BATTERIE	TEMPS DE RECHARGE	AUTONOMIE	IP/IK	PORTÉE D'ÉCLAIRAGE
1833XS/1	100	1 x AAA	-	5h	IP66	85m
1833XS/2	200	2 x AAA	-	10h	IP66	112m
1833S	500	2 x AA	-	10h	IP66	140m
1833M	700	3 x AAA	-	7.5h	IP66	170m
1833L	1100	3 x AA	-	8.5h	IP66	330m
1833L/USB	1200	Li-Ion 3.7 V; 2600 mAh	3.0h - USB-C	3.0h	IP66	230m
1833XL	1500	3xD	-	22h	IP66	290m
1834RR	130	Li-Ion 3.7 V; 550 mAh	2.0h	1h	IP30	-
1837F	500	3 x AA	-	14.5h	IP66	125m
1837F/USB	600	Li-Ion 3.7 V; 2900 mAh	4.0h - USB-C	10h	IP66	280m

1833L/USB

Torche LED rechargeable à haute luminosité en aluminium anodisé renforcé jusqu'à 1200 Lumens

- Cône lumineux réglable
- 3 réglage possible de luminosité
- batterie : 3H
- IP66
- Portée d'éclairage : 230 m
- témoin indicateur de charge de la batterie (<15%)
- chargement par port USB-C
- chargeur non inclus



L mm 240 CHF 148.00 1 018330054

1833RB-L/USB

Batterie de recharge pour 1833L/USB

CHF 68.00 1 018330975

1833XS/1

Torche d'inspection LED en aluminium anodisé renforcé

- 100 lumens
- Cône lumineux réglable
- piles : 1xAAA (non inclus)
- IP66
- autonomie : 5H
- Portée d'éclairage : 85 m



L mm 92 CHF 26.00 3 018330000

1833XS/2

Torche d'inspection LED en aluminium anodisé renforcé

- 200 lumens
- Cône lumineux réglable
- piles : 2xAAA (non inclus)
- IP66
- autonomie : 10H
- Portée d'éclairage : 112 m



L mm 133 CHF 28.00 3 018330001

1833S

Torche LED à haute luminosité en aluminium anodisé renforcé jusqu'à 500 Lumens

- Cône lumineux réglable
- 2 réglages possibles de luminosité
- piles: 2xAA (non inclus)
- Autonomie : 10H
- IP66
- Portée d'éclairage : 140 m



L mm 150 CHF 48.50 1 018330002

1833M

Torche LED à haute luminosité en aluminium anodisé renforcé jusqu'à 700 Lumens

- Cône lumineux réglable
- 2 réglages possibles de luminosité
- piles: 3xAAA (non inclus)
- témoin indicateur de charge des piles (<15%)
- Autonomie : 7.5h
- IP66
- Portée d'éclairage : 170 m



L mm 162 CHF 60.50 1 018330003

1833L

Torche LED à haute luminosité en aluminium anodisé renforcé jusqu'à 1100 Lumens

- Cône lumineux réglable
- 2 réglages possibles de luminosité
- piles: 3xAA (non inclus)
- témoin indicateur de charge des piles (<15%)
- Autonomie : 8.5h
- IP66
- Portée d'éclairage : 330 m



L mm 196 CHF 101.00 1 018330004

1833XL

Torche LED à haute luminosité en aluminium anodisé renforcé jusqu'à 1500 Lumens

- Cône lumineux réglable
- 2 réglages possibles de luminosité
- piles: 3xD (non inclus)
- témoin indicateur de charge des piles (<15%)
- Autonomie : 22h
- IP66
- Portée d'éclairage : 290 m



L mm 300 CHF 126.50 1 018330005

1834RR

Torche LED rechargeable avec prise allume-cigares

Cône lumineux réglable
Rechargeable sur prise allume-cigares 10-28V DC
IP30
130 lumens



1834RR CHF 67.00 1 018340520

1836AW

Lampe frontale à LED rechargeable sans fil, avec double émission de lumière

- Double émission de lumière :
front : 3 intensités de lumière LED COB 30 - 200 - 400 lumens
spot (tête): LED COB, 400 lumens
- Batterie rechargeable : Li-Ion 3.7 V, 1500 mAh, 5.55 Wh
- Avec port USB-C
- Câble USB-C inclus
- Temps de charge : 2,5 h
- Autonomie de la batterie :
front : 4-18 h
spot (tête): 4 h
- IP 65
- IK 07



1836AW CHF 91.00 1 018360051

1836B

Lampe frontale articulée à LED, rechargeable, à double intensité lumineuse et avec capteur ON/OFF

- Capteur ON/OFF sans contact
- 250 lumens
- Autonomie : 3-6 h
- IP65



1836B CHF 165.00 1 018360200

1837F

Lampe magnétique articulée à LEDs haute luminosité, en aluminium anodisé renforcé, jusqu'à 500 Lumens

- Cône lumineux réglable
- 2 intensités lumineuses
- Piles 3xAA (non fournies)
- Durée 14.5 h
- Indicateur de charge
- IP66



L mm 460 CHF 109.00 1 018370050

1837F/USB

Lampe rechargeable magnétique articulée à LEDs haute luminosité, en aluminium anodisé renforcé, jusqu'à 600 Lumens

- Cône lumineux réglable
- 2 intensités lumineuses
- Durée 10.0 h
- Recharge avec coupleur USB-C
- IP66



L mm 460 CHF 162.00 1 018370060

1837RB-F/USB

Batterie de rechange pour 1837F/USB

1837RB-F/USB	CHF 47.50	1	018370960
--------------	--------------	---	-----------

1838POCKET

Spot de poche articulé à LED, orientable, à double faisceau lumineux, rechargeable avec chargeur sans fil

- Double émission lumineuse :
- lumière principale: LED COB, 3 intensités lumineuses : 160 - 400 - 800 lumens
- lumière en tête (spot) : LED SMD, 250 lumens
- Angle d'éclairage : lumière principale: 160°
lumière spot : 18°
- Batterie rechargeable Li-ion 3.7V 2600mAh
- 2 modes de charge : base sans fil 1839BRW alimentateur avec connexion USB-C
- Temps de charge : 4.5 h avec base de recharge sans fil 4 h avec alimentateur
- Autonomie : lumière principale : 3-9h
lumière en tête (spot) : 4.5 h
- Indicateur de charge de la batterie à 3 LEDs
- Orientable à 210°
- Corps en caoutchouc antiglisse
- Base magnétique
- 1 aimant sur base
- IP65
- IK07
- Câble USB-C inclus



L mm	I mm	S mm	CHF	1	018380080
98	82	39	86.00		

1837C

Spot rechargeable à LED de chantier

- 3 intensités lumineuses
- charge batterie : input: 100-240 V AC - 50/60Hz ; output: 15V 1,5A
- temps de recharge : 4 heures
- indicateur de charge à 3 LED
- orientable à 180°
- IP65
- IK07



LxHxl mm	Lm	h	CHF	1	018370210
220x225x70	2100	2.5	240.50		
	1000	5.0			
	500	9.0			
266x236.6x59	4300	1.5	353.00		018370430
	2100	3.0			
	1100	6.0			

1837C/RA2100-4300

Alimentateur pour spot à LED 1837C/2100-4300



1837C/RA2100-4300	CHF 34.00	1	018370970
-------------------	--------------	---	-----------

1837M

Spot rechargeable à LED COLOUR MATCH, pour contrôle couleur, haut indice de rendu de couleur (IRC 96+), jusqu'à 2.000 lumens

- 3 intensités lumineuses : 500/1.000/2.000Lumen
- CRI (indice de rendu de couleur) : 96+
- CCT (température couleur) : 2700K/ 3500K/ 4500K/ 5500K/ 6500K
- charge batterie : input : 100-240V AC - 50/60Hz ; output : 15V 1.5A
- connecteur de recharge à décrochage rapide
- temps de recharge : 3.5 heures
- durée : 8/4/2 h
- indicateur de charge
- touche à LED indicateur de température couleur
- touche à led indicateur d'intensité lumineuse
- orientable à 180°
- IP65
- IK07



LxHxl mm	Lm	h	CHF	1	018370450
220x225x70	500	8.0	376.00		
	1000	4.0			
	2000	2.0			

1837M/RA

Alimentateur pour spot COLOUR MATCH 1837M



1837M/RA	CHF 64.50	1	018370975
----------	--------------	---	-----------

1837S

Trépied télescopique pour support spot de chantier

- En métal
- Hauteur variable 70+155 cm
- Compatible avec 1837C et 1838FLASH



h cm	CHF	1	018370500
70+170	78.00		

1838FLASH

Spot rechargeable compact, étudié pour offrir la meilleure solution possible en toute occasion.

ÉCLAIRAGE GÉNÉREUX ET TOUJOURS PRÊT : avec une capacité d'éclairage maximum de 720 lumens et la possibilité de travailler avec batterie ou câble, il est toujours prêt à l'emploi.

INSTALLABLE PARTOUT :

- sur plans : avec pieds en caoutchouc sur trois côtés ou avec entraînement de 1/4" pour chevalet (standard type appareil photo)

- sur structures métalliques : avec aimant dévissable ou crochet orientable à 360°

COMPACT : avec seulement 85x100x155 mm d'encombrement, il peut être logé de manière pratique dans la sacoche des outils et utilisé dans des lieux exigus.

ROBUSTE : étudié pour résister aux sollicitations mécaniques les plus sévères. Garantie de durée dans le temps.



IP65

1838FLASH	CHF 427.00	1	018380300
-----------	---------------	---	-----------

1838RB/FLASH

Batterie de rechange pour 1838/FLASH

1838RB/FLASH	CHF 93.00	1	018380930
--------------	--------------	---	-----------

1838/11LED

Lampe rechargeable à LEDs très haute luminosité

Batterie au lithium polymère

- Corps compact en caoutchouc antiglisse
- Verre frontal facile à remplacer
- Crochet orientable
- Avec station de recharge 110-230Vac
- 340 Lumen
- Avec led en tête pour éclairage multidirectionnel



1838/11LED CHF 209.00 1 018380111

1838RA/10-11LED

Alimentateur pour 1838/10LED et 1838/11LED

CE

1838RA/10-11LED CHF 44.00 1 018380903

1838RB/10LED

Batterie pour 1838/10LED et 1838/11LED

1838RB/10LED CHF 70.00 1 018380902

1838RR/11LED

Base de recharge pour 1838/11LED

1838RR/11LED CHF 46.50 1 018380914

1838RV/11LED

Verre frontal anti-écaflure pour lampe 1838/11LED



1838RV/11LED CHF 6.40 2 018380905

1838AM

lampe d'inspection LED rechargeable, avec double émission de lumière, articulée, peut être tournée à 180°, avec base magnétique pivotante et crochet

- double émission lumineuse : avant : LED COB, 60-700 lumens, peut être ajusté avec potentiomètre spot (tête) : LED SMD, 120 lumens, interrupteur ON-OFF
- batterie Li-ion rechargeable 3.6V 2600mAh
- avec port USB-C
- fourni avec chargeur 100-240V / 50-60Hz
- temps de charge: 4h
- autonomie de la batterie: front: 2.5-16h spot (tête): 10h
- Indicateur de niveau de batterie à 3 LED
- articulé, peut être tourné de 180° (± 90° par rapport à l'axe)
- base magnétique (avec aimant en néodyme), peut être tournée de 90°
- crochet de base pivotant
- IP54
- IK07



L I S L1
mm mm mm mm
1838AM 405 40 45 175 CHF 137.00 1 018380400

1838COB

Lampe à LED portable rechargeable

- Fixation murale, avec corps en caoutchouc antiglisse et antichoc
- Batterie au lithium polymère
- Base magnétique orientable à 180 degrés
- Avec chargeur 100-240Vac / 50-60Hz
- 100/200 lumens ; SPOT 75 lumens
- Autonomie : 6h / 3h ; SPOT 4h
- temps de recharge : 3 heures
- IP65

CE IP65



1838COB CHF 118.50 1 018380010

1838P

Lampe stylo rechargeable, avec double émission lumineuse : lampe ou torche

- Corps compact en caoutchouc antiglisse
- 75/150 lumens
- Crochet de poche
- Base magnétique orientable à 180 degrés
- Fournie avec câble de charge USB/jack 3,5mm
- Autonomie : 2,5 heures
- IP65



1838P CHF 101.50 1 018380005

1838SLIM

Lampe fine articulée rechargeable à 3 LEDs

- 3 émissions lumineuses
- Avant : 100/200 lumens / derrière : 180 lumens / tête (spot): 80 lumens
- Base magnétique
- Temps de recharge : 2.5h
- Autonomie : 2-4h/ spot 3h

CE IP54



L I S
mm mm mm
1838SLIM 307 17 29 CHF 92.50 1 018380221

Beta

Beta

1838SW

Lampe articulée à LED, rechargeable avec chargeur sans fil

- Double émission lumineuse : avant : LED COB, 3 intensités lumineuses : 250 - 500 - 1000 lumens en tête (spot) : LED SMD, 200 lumens
- Batterie rechargeable Li-ion 3.6V 3.350mAh
- 2 modes de charge : base sans fil 1839BRW alimentateur avec connexion USB-C
- Temps de charge : 6.5h avec base de recharge sans fil 4.5h avec alimentateur
- Autonomie : avant : 3-5h en tête (spot) : 7h
- Indicateur de charge de la batterie à 3 LEDs
- Base orientable à 180°
- Corps en caoutchouc antiglisse
- Double crochet orientable
- 3 aimants sur derrière
- 1 aimant sur base
- IP65
- IK07
- Câble USB-C inclus



L	I	S	CHF	1	018380142
mm	mm	mm			
260	53	40	122.50	1	018380142

1838UV

Lampe rechargeable UV + lumière blanche idéale pour la détection des fuites

- Corps compact en caoutchouc antiglisse
- Avec chargeur 100-240Vac / 50-60Hz
- 150 lumens / UV



CHF	1	018380150
199.50	1	018380150

1838E

Lampe LED rechargeable sous capot

- Triple émission de lumière: 500/1000/2000 lumens
- Orientable à 360°
- réglable en longueur: 116 ÷ 188 cm
- corps en aluminium
- crochets en caoutchouc antidérapants
- port de charge en USB-C
- 2 modes de charge: charge via le port USB de la lampe charge via le port USB de la batterie interne
- fourni avec chargeur de batterie entrée: 100-240V ~ 50 / 60Hz sortie: DC 5V - 2000 mA
- Autonomie: 3-9 h
- IP20
- IK07

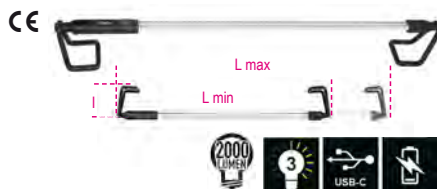

IP20
IK07

L min	L max	I	CHF	1	018380270
mm	mm	mm			
1170	1880	150	233.50	1	018380270

1838E-BT

Batterie rechargeable avec port USB-C pour lampe sous capot article 1838E

- Li-Ion 3,6V
- DC 5V - 2000 mA

CE

1838E-BT	CHF	1	018380271
	65.50	1	018380271

1839BRW

Base de recharge sans fil, compatible avec les lampes 1838POCKET, 1838SW

- Deux positions de charge avec fixation magnétique pouvant être utilisées simultanément
- Avec support amovible pour recharge sans fil du téléphone portable
- LED indicateur d'état de charge
- Puissance d'entrée max. : 10W x2
- Entrée : AC 100-240V 50/60Hz
- Sortie : DC 12V 1.5A
DC 9V 2A
DC 5V 3A
- Port USB-C
- Peut être accroché au mur au moyen de : 3 aimants puissants à l'arrière
2 trous pour les vis
- IP20
- IK07



L	I	S	CHF	1	018390002
mm	mm	mm			
101	190	28	116.00	1	018390002

1839/R5

Câble USB-C QC 3.0, pièce de rechange pour 1838POCKET, 1839BRW

1839/R5	CHF	1	018390505
	10.50	1	018390505

1839/R6

Transformateur de charge rapide USB Q C3.0, pièce de rechange pour 1838POCKET, 1839BRW

1839/R6	CHF	1	018390506
	31.00	1	018390506

1839/R1

Transformateur avec sortie USB, recharge pour 11833L/USB, 1836B, 1837F/USB, 1838COB, 1838P, 1838S, 1838SLIM, 1838UV, 1838AM, 1838E

CE

1839/R1	CHF	1	018390501
	30.50	1	018390501

1839/R2

Câble USB/jack 3,5 mm, recharge pour 1836B ; 1838P ; 1838COB; 1838UV

1839/R2	CHF	1	018390502
	11.70	1	018390502

1839/R4

Câble USB/USB-C, recharge pour 1833L/USB, 1833F/USB, 1838SLIM, 1838S, 1838AM, 1838E

1839/R4	CHF	1	018390504
	10.40	1	018390504

Beta

Beta

1840BM

Baladeuse standard
pour lampes avec culot E27
alimentation 230V

- Ampoule non fournie



IP20

V W L mm CHF 1 018400101
1840BM 230 60 420 88.50

1842LED/BM

Baladeuse à LEDs très haute luminosité, 100-240 Vac

- Câble de 10 m
- Corps compact en caoutchouc antiglisse
- Verre frontal facile à remplacer
- Crochet orientable
- 340 lumens
- Avec LED en tête pour éclairage multidirectionnel



V L mm CHF 1 018420301
1842LED/BM 230 173.00

1842LED/ABM

Baladeuse à LEDs très haute luminosité, 12-24V AC/DC

- Câble de 10 m
- Corps compact en caoutchouc antiglisse
- Verre frontal facile à remplacer
- Crochet orientable
- 320 lumens
- Avec LED en tête pour éclairage multidirectionnel



V L mm CHF 1 018420311
1842LED/ABM 230 163.50

ENROULEURS



La nouvelle gamme complète d'enrouleurs Beta a été conçue et développée dans le but de satisfaire toutes les exigences des professionnels.

- La gamme d'enrouleurs de câble comprend de nombreuses longueurs et types de câbles. Les enrouleurs disposent d'une gamme avec des lampes LED ou avec des prises électriques standard ou SCHUKO.
- La gamme d'enrouleurs de tuyaux comprend des tuyaux de 8 mm et 10 mm de diamètre.

Le ressort haute résistance assure une remarquable longévité et une utilisation tout en douceur. Le caisson en polypropylène épais, permet une résistance unique aux chocs.

Le dispositif Rack permet l'arrêt automatique du rembobinage du câble, il peut être désactivé facilement pour permettre une traction continue

Chaque enrouleur est équipé d'un support mural pivotant à 180 ° et d'un support supplémentaire permettant une connexion ou une déconnexion rapide d'avec celui-ci.

ENROULEURS DE CÂBLES

Une large gamme comprenant pas moins de 18 versions, conçue pour satisfaire toutes les exigences de travail, y compris les utilisateurs les plus exigeants. Leurs longueurs allant de 10 m à 30 m, et leurs sections allant de 2x1.0 mm² à 5Gx1.5 mm², avec les types de câbles H05VV-F et H07RN-F. Tous les enrouleurs de câble, jusqu'à une section de câble de 3Gx2.5 mm², sont fournis avec des commutateurs de protection thermique, qui sont déclenchés en cas de surcharge du circuit électrique.



ENROULEURS DE TUYAUX



337

La gamme sélectionnée, avec des longueurs allant de 10 m à 15 m et de 8 mm et 10 mm de diamètre, est préconisée pour une utilisation avec des outils pneumatiques.

Les enrouleurs étant étanches, ils peuvent également être utilisés avec projection d'eau.

Article		Conducteurs	Section	Type de câble	Longueur	Thermal protection	Accessoire
1842 15-H05/LED	018420821	2x	1,0 mm ²	H05VV-F	15+1 m	YES	Lampe LED
1843 15-H05	018430215	2x	1,5 mm ²	H05VV-F	15+1 m	YES	
1844 10-H05	018440310	3G	1,5 mm ²	H05VV-F	10+1 m	YES	-
1844 15-H05	018440315			H05VV-F	15+1 m	YES	-
1844 15-H07	018440317			H07RN-F	14+1 m	YES	-
1844 30-H05	018440330			H05VV-F	30+2 m	YES	-
1844 15-H05/SCK	018440316	3G	1,5 mm ²	H05VV-F	15+1 m	YES	SCHUKO
1844 15-H07/SCK	018440318			H07RN-F	14+1 m	YES	SCHUKO
1845 12-H05	018450365	3G	2,5 mm ²	H05VV-F	12+1 m	YES	
1845 15-H07	018450367			H07RN-F	15+1 m	YES	
1845 25-H07	018450377			H07RN-F	25+1,5 m	YES	
1846 10-H05	018460405	4G	1,5 mm ²	H05VV-F	10+1 m	NO	
1846 10-H07	018460407			H07RN-F	10+1 m	NO	
1846 15-H05	018460415			H05VV-F	15+1 m	NO	
1847 10-H05	018470420	4G	2,5 mm ²	H05VV-F	10+1 m	NO	
1847 15-H07	018470427			H07RN-F	15+1 m	NO	
1848 10-H05	018480510	5G	1,5 mm ²	H05VV-F	10+1 m	NO	
1848 15-H07	018480517			H07RN-F	15+1 m	NO	

1842

enrouleur de câble automatique avec lampe d'inspection LED, 100-240Vac

- avec transformateur de sécurité 230/12V
- Câble H05VV-F 2x1,0 mm²
- longueur du câble enroulé: 15 m
- Câble entrant de 1,5 m avec prise de type SCHUKO
- longueur du câble hors du tambour: 1 m
- le mécanisme de rack peut être désactivé pour garder le câble tiré
- fourni avec un support pivotant à 180 ° et un support de connexion rapide supplémentaire

CE



IP42
IP65

L=15 m



L
m

CHF



1842 15-H05/LED H05VV-F 15+1 438.00 1 018420821

1846R-LED/BM

Lampe à LED de recharge

12-24V - AC-DC



1846LED/BM R CHF 120.00 1 018460331

1843

enrouleur de câble automatique, avec câble 2x1,5 mm²

- Câble H05VV-F 2x1,5 mm²
- avec interrupteur de protection thermique
- longueur du câble enroulé: 15 m
- longueur du câble hors du tambour: 1 m
- fourni sans câble entrant
- le mécanisme de rack peut être désactivé pour garder le câble tiré
- puissance max. (enroulée): 1300W (230V-20 °C)
- puissance max. (déroulé): 2300W (230V-20 °C)
- fourni avec un support pivotant à 180 ° et un support de connexion rapide supplémentaire

CE



IP42



L
m

CHF



1843 15-H05 H05VV-F 15+1 292.00 1 018430215

1844

enrouleur de câble automatique, avec câble 3Gx1,5 mm²

- Câble 3Gx1,5 mm²
- avec interrupteur de protection thermique
- longueur du câble hors tambour: 1 m (sauf pour 1844 30-H05, 2 m)
- fourni sans câble entrant
- le mécanisme de rack peut être désactivé pour garder le câble tiré
- puissance max. (enroulée): 1500W (230V-20 °C)
- puissance max. (déroulé): 2500W (230V-20 °C)
- fourni avec un support pivotant à 180 ° et un support de connexion rapide supplémentaire

CE



IP42



L
m

CHF



Modèle	Câble	L (m)	CHF	Support	Connexion	Code
1844 10-H05	H05VV-F	10+1	260.00	1	1	018440310
1844 15-H05	H05VV-F	15+1	285.00	1	1	018440315
1844 15-H07	H07RN-F	14+1	310.00	1	1	018440317
1844 30-H05	H05VV-F	30+2	548.00	1	1	018440330

1844SCK

enrouleur de câble automatique, avec câble 3Gx1,5 mm² et prise de type SCHUKO

- Câble 3Gx1,5 mm²
- avec interrupteur de protection thermique
 - longueur du câble hors du tambour: 1 m
 - fourni avec câble entrant de 1,5 m et prise de type SCHUKO
 - le mécanisme de rack peut être désactivé pour garder le câble tiré
 - puissance max. (enroulée): 1500W (230V-20 °C)
 - puissance max. (déroulé): 2500W (230V-20 °C)
 - fourni avec un support pivotant à 180 ° et un support de connexion rapide supplémentaire

CE



IP42

L=15 m



L
m

CHF



Modèle	Câble	L (m)	CHF	Support	Connexion	Code
1844 15-H05/SCK	H05VV-F	15+1	298.00	1	1	018440316
1844 15-H07/SCK	H07RN-F	14+1	322.00	1	1	018440318

1845

enrouleur de câble automatique, avec câble 3Gx2,5 mm²

- Câble 3Gx2,5 mm²
- avec interrupteur de protection thermique
- longueur du câble hors tambour: 1 m (sauf pour 1845 25-H07RN-F, 1,5 m)
- fourni sans câble entrant
- le mécanisme de rack peut être désactivé pour garder le câble tiré
- puissance max. (enroulée): 2000W (230V-20 °C)
- puissance max. (déroulé): 3000W (230V-20 °C)
- fourni avec un support pivotant à 180 ° et un support de connexion rapide supplémentaire

CE



IP42



L
m

CHF



Modèle	Câble	L (m)	CHF	Support	Connexion	Code
1845 12-H05	H05VV-F	12+1	588.00	1	1	018450365
1845 15-H07	H07RN-F	15+1	588.00	1	1	018450367
1845 25-H07	H07RN-F	25+1,5	742.00	1	1	018450377

1846

enrouleur de câble automatique, avec câble 4Gx1,5 mm²

- Câble 4Gx1,5 mm²
- sans interrupteur de protection thermique
- longueur du câble hors du tambour: 1 m
- fourni sans câble entrant
- le mécanisme de rack peut être désactivé pour garder le câble tiré
- puissance max. (enroulée): 1400W (230V-20 °C)
- puissance max. (déroulé): 1900W (230V-20 °C)
- fourni avec un support pivotant à 180 ° et un support de connexion rapide supplémentaire

CE



IP42



L
m

CHF



Modèle	Câble	L (m)	CHF	Support	Connexion	Code
1846 10-H05	H05VV-F	10+1	316.00	1	1	018460405
1846 10-H07	H07RN-F	10+1	327.00	1	1	018460407
1846 15-H05	H05VV-F	15+1	327.00	1	1	018460415

1847

enrouleur de câble automatique, avec câble 4Gx2,5 mm²

- Câble 4Gx2,5 mm²
- sans interrupteur de protection thermique
- longueur du câble hors du tambour: 1 m
- fourni sans câble entrant
- le mécanisme de rack peut être désactivé pour garder le câble tiré
- puissance max. (enroulée): 2000W (230V-20 °C)
- puissance max. (déroulé): 2700W (230V-20 °C)
- fourni avec un support pivotant à 180 ° et un support de connexion rapide supplémentaire

CE



IP42

	L m	CHF		
1847 10-H05	H05VV-F 10+1	340.00	1	018470420
1847 15-H07	H07RN-F 15+1	632.00	1	018470427

1848

enrouleur de câble automatique, avec câble 5Gx1.5 mm²

- Câble 5Gx1,5 mm²
- sans interrupteur de protection thermique
- longueur du câble hors du tambour: 1 m
- fourni sans câble entrant
- le mécanisme de rack peut être désactivé pour garder le câble tiré
- puissance max. (enroulée): 1400W (230V-20 °C)
- puissance max. (déroulé): 1900W (230V-20 °C)
- fourni avec un support pivotant à 180 ° et un support de connexion rapide supplémentaire

CE



IP42

	L m	CHF		
1848 10-H05	H05VV-F 10+1	353.00	1	018480510
1848 15-H07	H07RN-F 15+1	675.00	1	018480517

1850D

Pistolet thermique à 3 vitesses

- Pos. I 250 l/min 50 °C
- Pos. II 250 l/min 400 °C
- Pos. III 500 l/min 550 °C

CE



	L mm	H mm	CHF		
1850D	255	210	163.00	1	018500018

1850E

pistolet thermique électronique réglable

- Pos. Je 250-500 l / min 50 °C
- Pos. II 250 à 500 l / min 50 à 650 °C

- affichage numérique
- boutons de réglage de la température et du débit
- 4 programmes prédéfinis et autres programmes personnalisables

- Prog 1 150 ° C env. 400 l / min
- Prog 2 200 ° C env. 400 l / min
- Prog 3 300 ° C env. 450 l / min
- Prog 4 400 ° C env. 500 l / min

CE



	L mm	H mm	CHF		
1850E	255	210	341.00	1	018500020

1851VK

Pistolet pour colle à chaud fourni avec 12 bâtonnets de colle thermofusible en coffret

- Puissance : 80 watts
- Pour colle en bâtonnet ø 11 et 12 mm

CE



	CHF		
1851VK	67.50	1	018510058

320x250x50 mm

1851VK-12C

12 bâtonnets de colle thermofusible ø 11 mm



	CHF		
1851VK-12C	17.20	1	018510062

1851VK-12V

12 bâtonnets de colle thermofusible

ø 11 mm



	CHF		
1851VK-12V	17.20	1	018510072

1852R1750

Pistolet à induction portable

CE



- Réchauffe et débloque les boulons, les écrous, les moyeux et les roulements particulièrement bloqués sans utiliser de flammes
- Permet de réchauffer tout type de métal ferromagnétique
- Pièces fournies :
 - Deux serpentins avant avec diamètre 19 et 26 mm pour déblocage écrous
 - Un serpentin plat pour réchauffer les surfaces
 - Un serpentin fil exible de 800 mm de longueur
 - Présenté dans un coffret en plastique

- Données techniques :
- tension d'entrée : 230V AC, 50/60 Hz
 - courant d'entrée : max. 7,5A
 - puissance : max. 1.75 kW

EN OPTION
D'autres mesures de serpentin sont disponibles

AVANTAGES
Économie de temps : réchauffement rapide et grande précision
Sécurité anti-incendie : ne génère pas de flammes, sécurité maximum pour l'opérateur
Pratique : utilisable avec une seule main et serpentins facilement interchangeables

DOMAINES D'APPLICATION
Automotive
Maintenance industrielle
Industrie aéronautique
Industrie navale
Industrie pétrochimique

	CHF		
1852R1750	1,920.00	1	018520175

480x370x130 mm - 4,5 kg

1852S-CNT

bobine de contact



	CHF		
1852S-CNT	144.00	1	018520520

1852S-CC

bobine de cuillère



	CHF		
1852S-CC	115.50	1	018520521

1852S-KR/CNT

kit de pièces de rechange pour bobine de contact



1852S-KR/CNT	CHF 62.50		1	018520522
--------------	--------------	--	---	-----------

1852S-L

Serpentins avec branchement sur le côté



	Ø mm	M	L mm	CHF		
1852S-L 19	19	M6	220	58.00	1	018520501
1852S-L 20	20	M8	220	58.00	1	018520502
1852S-L 23	23	M10	220	58.00	1	018520503
1852S-L 26	26	M12	220	58.00	1	018520504
1852S-L 32	32	M16	220	58.00	1	018520505
1852S-L 38	38	M20	220	67.00	1	018520506
1852S-L 45	45	M22	220	73.50	1	018520507

1852S-F

Serpentin avec branchement sur le devant



	Ø mm	M	L mm	CHF		
1852S-F 19	19	M6	220	58.00	1	018520508
1852S-F 20	20	M8	220	58.00	1	018520509
1852S-F 23	23	M10	220	58.00	1	018520510
1852S-F 26	26	M12	220	58.00	1	018520511
1852S-F 32	32	M16	220	58.00	1	018520512
1852S-F 38	38	M20	220	67.00	1	018520513
1852S-F 45	45	M22	220	71.50	1	018520514

1852S-FLESS

Serpentin flexible



	CHF		
1852S-FL 750	43.50	1	018520519
1852S-FL 800	109.00	1	018520515
1852S-FL1000	140.00	1	018520517
1852S-FL1500	166.00	1	018520518

1852 S-PIATTE

Serpentin plat



1852S-PIATTE	CHF 67.00		1	018520516
--------------	--------------	--	---	-----------

Beta

Beta
Quality Tools



SOUDAGE



POSTES À SOUDER À ONDULEUR

Postes à souder à onduleur faciles à utiliser, excellentes caractéristiques de soudage avec tous les types d'électrodes. Équipés d'un contrôle de surtension, de surchauffe et d'anti-collage de l'électrode. Compacts et légères, idéales pour les travaux d'entretien ménager, la menuiserie légère et les travaux d'entretien.



MASQUES POUR SOUDAGE

Beta propose différents masques LCD à obscurcissement automatique adaptés aux différents types de soudage : électrode, MIG/MAG, TIG et plasma. La protection et le confort sont garantis par le respect total de toutes les réglementations de sécurité en vigueur.



ACCESSOIRES DE SOUDAGE

Large gamme d'accessoires pour soutenir les opérations liées aux travaux de soudage.



POSTES À SOUDER POUR ÉTAIN ET AU GAZ

Postes à souder et accessoires conçus pour les petites opérations de maintenance et l'usinage dans le domaine de la microélectronique. En plus des soudeuses à câble, Beta propose diverses solutions au gaz butane qui permettent également de travailler en extérieur et en l'absence d'électricité.

1808

Fer à souder bi-watts avec panne droite pointue en acier 1824R8



W	V	CHF	Icon	Code
20/130	230	98.00	1	018080001

1812 150

Fer à souder instantané



W	V	CHF	Icon	Code
150	230	140.00	1	018120015

1814M

Fer à souder pour l'électronique avec panne droite en acier



W	V	CHF	Icon	Code
25	230	78.50	1	018140225
30	230	83.00	1	018140230
40	230	90.00	1	018140240

1820

Fer à souder



Model	W	V	CHF	Icon	Code
1820 30	30	230	58.00	1	018200003
1820 60	60	230	66.50	1	018200006
1820 80	80	230	94.00	1	018200008

1822

Fer à souder marteau



Model	W	V	CHF	Icon	Code
1822 120	120	230	144.00	1	018220012
1822 180	180	230	152.00	1	018220018
1822 320	320	230	189.00	1	018220032

1823 60

Poste de soudage thermorégulé à contrôle numérique

- Réglage continu de la température de 160 °C à 480 °C (précision ±1%).
- Fonction mémoire pour sauvegarde de la température sélectionnée au moment de l'arrêt.
- 3 touches de sélection rapide (200-300-400 °C).



W	CHF	Icon	Code
60	557.00	1	018230060

1823R/60

Fer à souder pour 1823 60



Model	W	CHF	Icon	Code
1823R 60	60	109.50	1	018230066



1824R

Panne pour fer à souder

Model	W	V	CHF	Icon	Code
1824R 08	20	130	41.50	1	018240100
1824R 12	30	150	5.65	1	018240301
1824R 14-M25	30	150	5.65	1	018240152
1824R 14-M30	30	150	5.65	1	018240153
1824R 14-M40	30	150	5.65	1	018240154
1824R 20	30	180	7.45	1	018240302
1824R 60	60	180	7.45	1	018240303
1824R 80	80	180	10.80	1	018240304
1824R 120-180	120-180	180	87.50	1	018240305
1824R 320	320	180	111.00	1	018240307
1824R ST-60	60	180	15.40	1	018240308

1825B

Fil à souder en étain avec antioxydant

- fil de 1 mm²; 250 g
- Sn 99.3%; Cu 0.7%



Model	W	CHF	Icon	Code
1825B	250g	82.00	1	018250251

1827

Fer à souder au gaz réglable



Model	W	CHF	Icon	Code
1827	24V	176.00	1	018270001

1827PC

Pannes coniques pour 1827



Model	W	CHF	Icon	Code
1827PC 1,6	1,6	36.50	1	018270501
1827PC 3,2	3,2	36.50	1	018270502

1827PCL

Pannes à lame pour 1827



Model	W	CHF	Icon	Code
1827PCL 2,4	2,4	36.50	1	018270503

1827PFL

Pannes à flamme nue pour 1827



1827PFL CHF 36.50 1 018270504

1827/K

Fer à souder au gaz avec 7 accessoires en coffret avec plateau en mousse compacte



- Puissance : de 30 Watts jusqu'à 125 Watts
- Température de la panne réglable de 250 °C jusqu'à 500 °C
- Régulateur du flux de gaz
- Temps de réchauffement : 15 secondes après l'allumage
- Réservoir contenant assez de gaz pour 120 minutes d'utilisation en continu
- Réservoir transparent permettant de surveiller le niveau du gaz
- Rechargeable avec du gaz butane

1827/K CHF 272.00 1 018270100

1827F

Mini lampe à souder à gaz butane rechargeable
Réservoir de 35 g

- Trois buses interchangeables de 550 °C ; 1000 °C et 1300 °C
- Fournie avec trépied dans coffret rigide



1827F CHF 193.50 1 018270200

1830T

Pompe à dessouder avec embout antistatique en matière plastique



L mm 190 CHF 20.70 5 018300021

1860BH/120A

Poste à souder à onduleur en courant continu (DC) pour le soudage MMA avec électrodes rutiles, basiques et en acier inoxydable.

Compact et facile à transporter

Fonctions arc réglable (arc force), démarrage à chaud (hotstart), anti-collage (anti-sticking), protection thermostatique

Courant de réglage : 10÷120A
Alimentation : 1x230V

Facteur d'utilisation (40 °C) :

25% - 120 A

50% - 80 A

100% - 60 A

Protection : IP22S

Électrodes utilisables: Ø 1.6 - 3.2mm rutiles, basiques, inox, fonte etc.

Fourni avec câbles de 16 mm²

CE



1860BH/120A CHF 429.00 1 018600121

1860BH/160A

Poste à souder à onduleur en courant continu (DC) pour le soudage MMA avec électrodes rutiles, basiques et en acier inoxydable.

Compact et facile à transporter

Fonctions arc réglable (arc force), démarrage à chaud (hotstart), anti-collage (anti-sticking), protection thermostatique

Courant de réglage : 10÷160A
Alimentation : 1x230V

Facteur d'utilisation (40 °C) :

25% - 160 A

60% - 100 A

100% - 80 A

Protection : IP22S

Électrodes utilisables: Ø 1.6 - 4mm rutiles, basiques, inox, fonte etc.

Fourni avec câbles de 16 mm²

CE



1860BH/160A CHF 553.00 1 018600161

1860BH/200A

Poste à souder à onduleur en courant continu (DC) pour le soudage MMA avec électrodes rutiles, basiques et en acier inoxydable.

Compact et facile à transporter

Fonctions arc réglable (arc force), démarrage à chaud (hotstart), anti-collage (anti-sticking), protection thermostatique

Courant de réglage : 10÷160A
Alimentation : 1x230V

Facteur d'utilisation (40 °C) :

25% - 200 A

60% - 130 A

100% - 100 A

Protection : IP22S

Électrodes utilisables: Ø 1.6 - 4mm rutiles, basiques, inox, fonte etc.

Fourni avec câbles de 16 mm²

CE



1860BH/200A CHF 615.00 1 018600201

1860BH R/CM

Câbles de masse pour poste à souder à onduleur 1860BH-120/160/200A



1860BH R/CM CHF 59.00 1 018600612

1860BH R/CS

Câbles de pince porte-électrode pour poste à souder à onduleur 1860BH-120/160/200A



1860BH R/CS CHF 72.00 1 018600613

1860BHT/160A

Poste à souder à onduleur en courant continu (DC) pour soudage à l'électrode MMA et TIG sur acier. Compact et facile à transporter. Fonctions arc réglable (arcforce), STICK/TIG (lift arc), démarrage à chaud (hotstart), anti-collage (anti-sticking), protection thermostatique.

Courant de réglage : 10÷160A

Alimentation : 1x230V

Facteur d'utilisation (40 °C) :

60 % - 160 A

100 % - 130 A

Protection : IP23S

Électrodes utilisables : Ø 1,6 - 4 mm rutiles, basiques, en acier inoxydable.

Fourni avec câbles de 25 mm²

CE



1860BHT/160A	CHF	1,078.00	1	018600179
--------------	-----	----------	---	-----------

1860BHT R/CM

Câbles de masse pour poste à souder TIG 1860BHT



1860BHT R/CM	CHF	91.50	1	018600616
--------------	-----	-------	---	-----------

1860BHT R/CS

Câbles de pince de soudage pour poste à souder TIG 1860BHT



1860BHT R/CS	CHF	118.50	1	018600617
--------------	-----	--------	---	-----------

1860M

Étau d'angle magnétique avec réglage rapide pour le soudage

Avec mors oscillants

idéal pour bloquer les pièces de différentes tailles

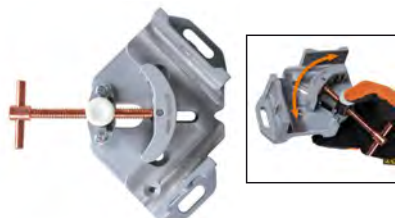

1860M	L max mm	30	CHF	110.50	1	018600301
-------	----------	----	-----	--------	---	-----------

1860DM

Disque magnétique pour levage de tôles

Idéal pour la manipulation et la fixation de tôles

Force magnétique constante sur toute la surface du disque

Poignées à trous pour faciliter l'usinage vertical



	kg max	CHF		
1860DM 16	16	63.00	1	018600310
1860DM 40	40	89.00	1	018600311

1860PMIG

Pince multi-usages pour le soudage MIG



	L mm	L1 mm	CHF	
1860PMIG	215	44	46.00	2
				018600350

1860EI

Équerre magnétique 90°, pour angles internes et externes

Idéal pour positionner vos pièces avant de souder

18 kg de force magnétique

avec ébavurage pour angles de 30 et 60°

et orifice hexagonal pour faciliter le détachement de l'aimant du métal



	L mm	L1 mm	S mm	CHF	
1860EI	165	110	35	44.50	1
					018600290

1860RG

Équerre magnétique réglable 30°÷270°

Idéal pour positionner vos pièces avant de souder

15 kg de force magnétique

Clé 6 pans fournie pour blocage réglage angle

embout fourni pour blocage réglage à 30°-45°-90°/270°-180°

Avec orifice hexagonal pour faciliter le détachement de l'aimant du métal



	L mm	S mm	CHF	
1860RG	155	35	71.50	1
				018600255

1860SQ

Équerre magnétique 45°/90°

Idéal pour positionner vos pièces avant de souder

25 kg de force magnétique

sans pile, effet marche/arrêt obtenu avec l'inclinaison des aimants internes

L'interrupteur sur arrêt permet de démagnétiser l'aimant et de se débarrasser de limailles de fer



1860SQ	CHF	108.50	1	018600210
--------	-----	--------	---	-----------

7041LCD/4S

Masque LCD à obscurcissement automatique pour soudure à électrode ; MIG/MAG ; TIG et plasma.

4 capteurs

avec filtre TRUE COLOR

alimentation à cellules solaires et batteries au lithium pour une durée exceptionnelle du filtre LCD

- aire visuelle 98x80 mm
- tonalité d'obscurcissement variable 5÷8,5/9-13 avec réglage interne
- protection UV/IR : DIN16
- temps d'obscurcissement 1/25000 s
- temps d'éclaircissement 0,1-2,0 s
- sensibilité et retard de l'obscurcissement réglables
- mise en marche et arrêt automatiques
- fonction de meulage
- indicateur bas niveau de la batterie
- design ergonomique, léger et bien équilibré
- avec douille réglable



CE

7041LCD/4S	CHF	353.00	1	070410001
------------	-----	--------	---	-----------

7041LCD/4S-VE

Verre frontal anti-écaillage externe pour 7041LCD/4S

7041LCD/4S-VE	CHF	8.60	2	070410101
---------------	-----	------	---	-----------

7041LCD/4S-VI

Verre interne pour 7041LCD/4S

7041LCD/4S-VI	CHF	4.35	2	070410102
---------------	-----	------	---	-----------

Beta
Quality Tools

7042LCD

Masque LCD à obscurcissement automatique pour soudage à l'électrode; MIG/MAG; TIG et plasma.

Alimentation par cellules solaires et batteries au lithium pour une durée exceptionnelle du filtre LCD

- Champ de vision 98x43 mm
- Tonalité d'obscurcissement DIN 9-13 avec réglage externe
- Protection UV/IR
- Temps d'obscurcissement 1/25000 s
- Temps d'éclaircissement 0.25-1s
- Sensibilité et retard de l'obscurcissement réglables
- Mise en marche et arrêt automatiques
- Fonction de meulage
- Forme optimisée pour faciliter la respiration lorsque la visière est abaissée



7042LCD CHF 248.00 1 070420001

7042LCD/RV

Verre anti-éclaboussures pour 7042LCD, 7043

7042LCD/RV CHF 3.90 2 070420101

7042LCD/RV-INT

Écran intérieur pour 7042LCD, 7043

7042LCD/RV-INT CHF 3.45 2 070420102

7043

Masque LCD à obscurcissement automatique, pour soudage à l'électrode, MIG/MAG, TIG et plasma.

Alimentation par cellules solaires.

- Champ de vision 92x43 mm
- Tonalité d'obscurcissement DIN 9-13 avec réglage externe
- Protection UV/IR
- Temps d'obscurcissement 1/1000 s
- Temps d'éclaircissement 0.1-1.0 s
- Retard de l'obscurcissement réglable
- Mise en marche et arrêt automatiques
- Fonction de meulage
- Forme optimisée pour faciliter la respiration lorsque la visière est abaissée



7043 CHF 144.00 1 070430001

1870

Aspirateur 20 litres eau et poussières pour usage professionnel

- moteur by-pass mono-étagé
- tension 230/240 V
- fréquence 50/60 Hz
- puissance maxi 1200 W
- débit d'air l/sec. 58
- dépression maxi 190 mbars
- volume de la cuve : 20 l en plastique antistatique
- niveau sonore <70 dB(A)
- longueur câble 5 m
- chariot porte-accessoires
- ACCESSOIRES FOURNIS Ø 36 mm
- 1 flexible aspiration 1,5 m
- 2 tubes aspiration rigides en plastique
- 1 suceur brosse multifonctions eau et poussières
- 1 suceur fente long
- SYSTÈMES FILTRANTS
- 1 filtre cartouche surface 1900 cm² - 12 microns nom.
- 1 filtre mousse PPI 45/PPI 30



IPX4

1870 CHF 291.00 1 018700020

1870I

aspirateur solide et fluide, 20 l, tambour en acier inoxydable

- moteur de by-pass à un étage
- tension : 230/240 V
- fréquence : 50/60 Hz
- puissance max. : 1200 W
- débit d'air : 58 l/sec.
- pression d'aspiration max. : 190 mbar
- capacité maximale du tambour: 20 l, en acier inoxydable
- émissions acoustiques : <70 dB(A)
- longueur du câble: 5 m ACCESSOIRES STANDARD Ø 36 mm
- 1 tuyau ondulé avec poignée ergonomique et évent
- 2 tubes d'extension durs
- 1 brosse multi-utilisation pour sols et fluides
- 1 buse plate
- 1 sac en papier SYSTÈMES DE FILTRAGE
- 1 cartouche de filtre à air de surface 1900 cm² - 12 µm nom.
- 1 filtre anti-mousse PPI 45/PPI 30



IPX4

1870I CHF 324.00 1 018700220

1872L

Aspirateur 35 litres pour solides et liquides classe certifiée "L"

- Moteur by-pass bi-étagé
- Tension 230/240 V
- Fréquence 50/60 Hz
- Puissance max. 1100 W
- Débit d'air 55 l/sec.
- Dépression max. 220 mbar
- Capacité max. bidon 35 l en PE-HD antistatique
- Émissions acoustiques <68 dB(A)
- Longueur câble 6 m
- ACCESSOIRES FOURNIS Ø 36 mm
- 1 tuyau cannelé avec branche ergonomique
- 2 tuyaux de rallonge en plastique
- 1 suceur combiné 2 positions
- 1 suceur avec raclette en caoutchouc pour l'aspiration de liquides
- 1 embout à lance
- SYSTÈMES FILTRANTS
- 1 sac en tissu non tissé classe de filtrage "L"
- 1 cartouche filtre classé IFA classe "L"
- 1 filtre anti-mousse PPI 45/PPI 30
- 2 post-filtres en PET associé à PP



IPX4

1872L CHF 634.00 1 018720135

1873

Aspirateur 30 litres eau et poussières pour usage professionnel en acier INOX

- moteur by-pass bi-étagé • tension 230/240 V
- fréquence 50/60 Hz • puissance maxi 1100 W
- débit d'air l/sec. 55 • dépression maxi 220 mbars
- volume de la cuve: 30 l en acier inox
- niveau sonore <61 dB(A) • longueur câble 6 m
- chariot porte-accessoires
- ACCESSOIRES FOURNIS Ø 45 mm
- 1 flexible d'aspiration 2 m avec poignée ergonomique - grande amplitude de travail
- 2 tubes rallonges d'aspiration rigides en acier inox
- 1 porte-suceur brosse pour sols
- 1 suceur brosse articulée pour sols et moquettes
- 1 suceur avec raclette en caoutchouc
- 1 suceur fente long • 1 buse d'aspiration triangulaire
- SYSTÈMES FILTRANTS
- 1 sac en papier filtre
- 1 filtre cartouche surface 1900 cm² 12 microns nom.
- 1 filtre mousse PPI 45/PPI 30



1873 30 CHF 846.00 1 018730030

1874

Aspirateur 50 litres eau et poussières pour usage professionnel en acier inox

- moteur by-pass bi-étagé • tension 230/240 V
 - fréquence 50/60 Hz • puissance maxi 1350 W
 - débit d'air l/sec. 55 • dépression maxi 240 mbars
 - volume de la cuve: 50 l en acier inox
 - niveau sonore <63 dB(A) • longueur câble 6 m
 - chariot porte-accessoires
- ACCESSOIRES FOURNIS Ø 45 mm
- 1 flexible d'aspiration 2 m avec poignée ergonomique - grande amplitude de travail
 - 2 tubes rallonges d'aspiration rigides en acier inox
 - 1 porte-suceur brosse pour sols
 - 1 suceur brosse articulée pour sols et moquettes
 - 1 suceur avec raclette en caoutchouc pour aspiration de liquides
 - 1 suceur fente long
 - 1 buse d'aspiration triangulaire
- SYSTÈMES FILTRANTS
- 1 sac en papier filtre • 1 filtre cartouche surface 5200 cm² 12 microns nom.
 - 1 filtre mousse PPI 45/PPI 30

CE



1874 50 CHF 1,068.00 1 018740050

1875LT

Nettoyeur pour moquettes et tissus d'ameublement à injection et extraction

Parfait pour laver en profondeur les surfaces textiles. Emploie un détergent pulvérisé sous pression et l'aspire avec la saleté, laissant les surfaces pratiquement sèches.

Accessoires fournis :

- 1 tuyau flexible avec branche ergonomique
- 1 groupe de distribution
- 2 rallonges rigides
- 1 petit embout de pulvérisation
- 1 grand embout de pulvérisation
- 6 douilles de blocage du câble d'alimentation électrique

CE



1875LT CHF 735.00 1 018750000

1875SP/K3

Kit de brosses pour le nettoyage des tissus

- 1 brosse plate Ø 48 mm
- 1 brosse plate Ø 100 mm
- 1 brosse hémisphérique Ø 90 mm
- coupleur pour clé à chocs 1/4"

1/4



ISO 1173 E 6,3

1875SP/K3 CHF 23.70 1 018750010

1870-20/5S

5 sacs en papier horizontaux pour 1870-1875LT



1870 20/5S CHF 68.00 1 018700021

1870-72 /FC

Filtre cartouche surface 1900 cm² 12 microns nom. pour 1870 - 1870I - 1873 - 1875LT

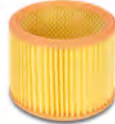

1870-72 /FC CHF 58.00 1 018700026

1870-72/FL

Filtre pour aspiration liquides pour 1870 - 1870I - 1872L - 1873 - 1874 - 1875LT



1870 72/FL CHF 21.60 1 018700027

1872L 35/FC

Filtre à cartouche classe "L" pour 1872L 35



1872L 35/FC CHF 70.50 1 018720144

1872L 35/5S

5 sacs en tissu non-tissé classe "L"



1872L 35/5S CHF 108.00 1 018720136

1873-30/5S

5 sacs en papier verticaux pour 1873



1873 30/5S CHF 68.00 1 018730031

1874-50/5S

5 sacs verticaux pour 1874



1874 50/5S CHF 86.00 1 018740051

1874-50/FC

Filtre cartouche surface 5200 cm² 12 microns nom. pour 1874



1874 50/FC CHF 70.00 1 018740056

1877

Récupérateur para gravité de 90 litres avec bac et grille Récupérateur d'huile par gravité de 90 litres avec bac et grille

- indicateur de niveau
- entonnoir de grand diamètre avec égouttoir à filtre de 12 litres
- vidage pneumatique du réservoir avec tuyau de 1,8 m
- bac porte-outils

CE



1877 CHF 915.00 1 018770008

Beta

1877A

Récupérateur à double fonction par aspiration et par gravité de 90 litres avec préchambre

- indicateur de niveau
- entonnoir de grand diamètre avec égouttoir à filtre de 12 litres
- préchambre transparente de 9,5 litres
- tuyau d'aspiration de 1,8 m
- vidage pneumatique du réservoir avec tuyau de 1,8 m
- bac porte-outils

Pièces fournies :

- 1 sonde rigide Ø 5x700 mm
- 1 sonde flexible Ø 5x700 mm
- 1 sonde rigide Ø 6x600 mm
- 1 sonde flexible Ø 6x700 mm
- 1 sonde flexible Ø 7x700 mm
- 1 sonde flexible Ø 8x700 mm
- adaptateurs pour VW, BMW, CITROËN

CE



1877A CHF 1.620.00 1 018770080

1877F

Récupérateur d'huile usée pour flacons de 1 litre

- Peut contenir jusqu'à 4 flacons simultanément
- 2 bidons de 2 l inclus



H mm 405 L mm 270 P mm 240 CHF 124.50 1 018770100

REPARATION DE VEHICULES

Nos outils de réparation de véhicules qui sont utilisés par les professionnels les plus exigeants, sont développés et fabriqués pour répondre aux normes les plus élevées du monde, et régulièrement testés dans les conditions de fonctionnement les plus difficiles.

Depuis plus de 50 ans, nous travaillons fièrement et en collaboration les plus grands champions des sport mécaniques, nous aidant à améliorer continuellement nos produits et témoignant du niveau de qualité PREMIUM.

Les outils de réparations de véhicules se trouvent dans les sections:

Diagnostics	articles 1438 to 1499 articles 1758VT to 1760TMC
Moteur	articles 955 to 989A articles 1438 to 1499
Vidange	articles 1438 to 1499 articles 1877 to 1885
Système électrique	articles 1438 to 1499
Boosters de démarrage	articles 1498BC/12 to 1498/40A
Transmission	articles 1438 to 1499
Suspension	articles 1549 to 1569CP
Freins	articles 1438 to 1499
Roues	articles 955 to 989A
Carrosserie	articles 1302 to 1369 articles 1763 to 1767A
Autres équipements	articles 1878 to 3067
Levage	articles 3029/2T to 3067/70-13T



1878 2

Cuve pour récupération des liquides

- Capacité maximale 2 l
- Particulièrement indiquée pour le remplacement huile sur les scooter



1878 2 l 2 H mm 85 CHF 18.70 1 018780002

1878 3

Cuve pour récupération de l'huile moyeux camions

Écoulement de l'huile avec anti-gouttes



1878 3 l 3 CHF 28.00 1 018780003

1878 4

Cuve transportable pour récupération des liquides

- Indiquée pour moto
- Capacité maximale 4 l
- Limite les éclaboussures



1878 4 l 4 H mm 100 CHF 39.50 1 018780004

1878 8

Cuve pour récupération des liquides

- Hauteur adaptée pour moto
- Capacité maximale 8 l



1878 8 l 8 H mm 110 CHF 21.10 1 018780008

1878 11

Cuve pour récupération des liquides

- Capacité maximum : 11 l
- Bouchon d'écoulement liquides
- Cloison intérieure pour éviter le débordement des liquides pendant le transport



1878 11 11 CHF 47.00 1 018780011

1878 30

Cuve de récupération des liquides

- Capacité maximum : 30 l
- Grille anti-éclaboussures
- Munie de 4 roues pivotantes

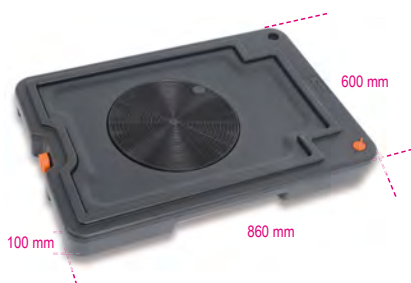

1878 30 30 CHF 183.00 1 018780030

1879

Aspirateur pour liquides manuel et pneumatique (9,5 l)



1879 CHF 394.00 1 018790001

1879 6

Aspirateur manuel pour liquides (6 l)



1879 6 CHF 288.00 1 018790000

1879R/K4

Kit de 4 tubes pour aspirateur pour liquides 1879



1879R/K4 CHF 76.00 1 018790504

1879/FUEL

Aspirateur manuel des liquides de 6 litres

Utilisable pour hydrocarbures



1879/FUEL 6 CHF 171.00 1 018790010

1880

Pompe à levier pour fûts d'huile

- Pour huile et liquides non agressifs
- Ne pas utiliser avec liquides à base aqueuse, solvants acides, le gasoil, l'essence et autres produits semblables
- Fournie avec fixation fût, tube télescopique et bec verseur
- Utilisable avec fûts de 60, 100 et 200 litres



1880 gr 240 CHF 74.50 1 018800001

1880ADB

Pompe rotative pour AdBlue®

- 5 litres toutes les vingt rotations
- rallonges pour fûts jusqu'à 1,20 m
- 1 attache pour fûts pas fin
- 1 attache pour fûts pas gros



1880ADB CHF 173.00 1 018800101

1881

Pompe pneumatique pour fûts rapport 3:1

CE



1881 l/min 18 CHF 634.00 1 018810001

1882

Pistolet à huile extrêmement flexible et anti-gouttes automatique

- Raccord 1/2"
- Débit maximum 65 l/min
- Pression de service maximum 100 bars
- Possibilité de verrouiller le levier de distribution



1882 CHF 191.00 1 018820010

1883

Compteur de litres numérique pour huile

- Raccord 1/2"
- Revêtement en caoutchouc antichoc
- 1 pile CR2 (fournie)
- Débit max : 0÷35 l/min (0÷9 gal/min)
- Pression max : 50 bars (750 psi)
- Viscosité : 8÷5000 mPas
- Tolérance : ±0,5%

CE



1883 CHF 290.00 1 018830035

1883NC

Niplex mâle-mâle 1/2 pour unir art. 1882 et 1883



1883NC CHF 18.00 1 018830135

1884

Outil pour l'introduction d'huile dans les boîtes de vitesses manuelles, automatiques et les différentiels
Comprend 12 adaptateurs pour la connexion directe



1884 CHF 626.00 1 018840010

AT-101	FORD
AT-102	UNIVERSAL (Bmw, Honda, Nissan...)
AT-103	VW-AUDI
AT-104	VW-AUDI-PORSCHE
AT-105	VW-AUDI-MINI COOPER
AT-106	MERCEDES
AT-107	DSG
AT-108	VW-AUDI CVT
AT-109	VOLVO
AT-110	TOYOTA-LEXUS
AT-111	SKODA
AT-112	VW Passat/Tiguan <2007

1884/C12

Coffret d'adaptateurs pour 1884



1884/C12 CHF 232.00 1 018840100

1884N/C8

Jeu de 8 adaptateurs pour 1884

contenu du jeu :

- 1 adaptateur pour Infiniti, 7 vitesses, M8x1.0
- 1 adaptateur pour Honda, Hyundai, Kia 5x8x200 mm
- 1 adaptateur pour Skoda M18x1.5
- 1 adaptateur pour Mini M14x1,5
- 1 adaptateur pour Nissan M10x1.5
- 1 adaptateur pour Nissan Juke M12x1.25
- 1 adaptateur pour GM M12x1.75
- 1 adaptateur pour véhicules du groupe VAG, 7 vitesses



1884N/C8 CHF 152.00 1 018840200

200x145x40 mm - 400 g

1889

Base en acier pour manipulation et stockage de 2 fûts de 200 l

- Complètement vernie à chaud avec poudres époxydiques
- Facilement transportable avec chariot élévateur à fourches ou transpalette
- Support non superposable

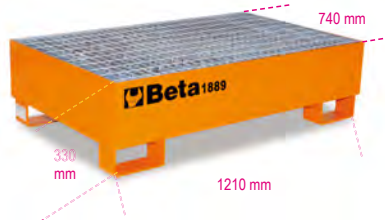

1889 CHF 1,043.00 1 018890200

1889CF

Clé universelle pour l'ouverture des fûts

- 1 hexagone femelle Ø 38 mm
- 1 profil à 4 secteurs Ø 42 mm
- 1 lame 17x7 mm



L mm 270 CHF 44.00 1 018890010

1885

Poste pour la maintenance de la boîte de vitesses automatiques

Permet d'effectuer en toute sécurité, avec une procédure simple et guidée, le cycle complet de lavage et de remplacement de l'huile dans toutes les transmissions automatiques. Préviend l'endommagement dérivant de l'usure de l'huile présente dans la boîte de vitesses automatiques, en prévenant de manière pratique et rapide les dysfonctionnements caractéristiques tels que : le bruit excessif de la boîte de vitesses, les vitesses bloquées, les enclenchements brusques des vitesses, l'allongement du temps de changement de vitesse.



CE



CARACTÉRISTIQUES FONCTIONNELLES

Fonctionnement automatique
Procédure guidée avec base de données intégrée
Compensation de la quantité de l'huile introduite avec la même quantité d'huile usée, garantissant ainsi la présence constante de la juste quantité d'huile dans le système
Débitmètre pour contrôle visuel de la qualité de l'huile
Impression de chaque opération effectuée

CARACTÉRISTIQUES AUTOMATIQUES

Introduction de solvant (facultative)
Lavage boîte de vitesses
Vidange d'huile de la coupe
Vidange d'huile du convertisseur
Introduction d'huile dans le convertisseur

CARACTÉRISTIQUES TECHNIQUES

Alimentation : 220 V 50 Hz
Viseurs huile rétroéclairés avec 2 LED lumière blanche
2 balances électroniques
Balances électroniques résolution +/- 10 g
Carte électronique avec écran d'affichage graphique rétroéclairé

1885 CHF 11,090.00 1 018850010

Beta

Beta

1885/C1

Kit raccords boîte de vitesses automatiques pour 1885

Le kit comprend :

- 1885/C1-R1 raccord boîte de vitesses Land Rover Freelander
- 1885/C1-R2 raccord boîte de vitesses DP0
- 1885/C1-R3 raccord boîte de vitesses ZF 9HP
- 1885/C1-R4 tige de niveau boîte de vitesses ZF 9HP
- 1885/C1-R5 tige de niveau boîte de vitesses Mercedes
- 1885/C1-R6 raccord boîte de vitesses AISIN TG82
- 1885/C1-R7 raccord boîte de vitesses AISIN TG81
- 1885/C1-R8 raccord boîte de vitesses Renault-Nissan



1885/C1 CHF 955.00 1 018850110

1885/C1-R1

Raccord boîte de vitesses Land Rover Freelander pour 1885

Ic01430



1885/C1-R1 CHF 82.50 1 018850111

1885/C1-R2

Raccord boîte de vitesses DP0 pour 1885

Ic0990



1885/C1-R2 CHF 144.00 1 018850112

1885/C1-R3

Raccord boîte de vitesses ZF 9HP pour 1885

Ic0992



1885/C1-R3 CHF 160.50 1 018850113

1885/C1-R4

Tige de niveau boîte de vitesses ZF 9HP pour 1885

Ic0192



1885/C1-R4 CHF 89.00 1 018850114

1885/C1-R5

Tige de niveau boîte de vitesses Mercedes pour 1885

K-A-M



1885/C1-R5 CHF 148.00 1 018850115

1885/C1-R6

Raccord boîte de vitesses AISIN TG82 pour 1885

Ic01820



1885/C1-R6 CHF 158.50 1 018850116

1885/C1-R7

Raccord boîte de vitesses AISIN TG81 pour 1885

Ic0150



1885/C1-R7 CHF 158.50 1 018850117

1885/C1-R8

Raccord boîte de vitesses Renault-Nissan pour 1885

Ic02150



1885/C1-R8 CHF 158.50 1 018850118

1885/C2

Kit raccords boîte de vitesses automatiques pour 1885

Le kit comprend :

- 1885/C2-R1 raccord boîte de vitesses Audi 8HP
- 1885/C2-R2 raccord boîte de vitesses ZF 9HP sans échangeur
- 1885/C2-R3 raccord boîte de vitesses Audi 0K0
- 1885/C2-R4 raccord boîte de vitesses AG4-ZF 4HP
- 1885/C2-R5 raccord boîte de vitesses FIAT
- 1885/C2-R6 raccord boîte de vitesses Audi Q5-Q7
- 1885/C2-R7 raccord boîte de vitesses Audi 0B5



1885/C2 CHF 776.00 1 018850120

1885/C2-R1

Raccord boîte de vitesses Audi 8HP pour 1885

Ic0993



1885/C2-R1 CHF 155.50 1 018850121

1885/C2-R2

Raccord boîte de vitesses ZF 9HP sans échangeur pour 1885

Ic0860



1885/C2-R2 CHF 101.50 1 018850122

1885/C2-R3

Raccord boîte de vitesses Audi 0K0 pour 1885

Ic02020



1885/C2-R3 CHF 158.50 1 018850123

1885/C2-R4

Raccord boîte de vitesses AG4-ZF 4HP pour 1885

Ic0750



1885/C2-R4 CHF 137.00 1 018850124

1885/C2-R5

Raccord boîte de vitesses FIAT pour 1885

Ic0061



1885/C2-R5 CHF 60.00 1 018850125

1885/C2-R6

Raccord boîte de vitesses Audi Q5-Q7 pour 1885

Ic0680



1885/C2-R6 CHF 148.00 1 018850126

1885/C2-R7

Raccord boîte de vitesses Audi 0B5 pour 1885

Ic01720



1885/C2-R7 CHF 89.00 1 018850127

1885/C3

Kit raccords boîte de vitesses automatiques pour 1885

Le kit comprend :

- 1885/C3-R1 raccord boîte de vitesses DSG Mercedes
- 1885/C3-R2 raccord boîte de vitesses POWERSHIFT
- 1885/C3-R3 raccord boîte de vitesses Toyota IQ
- 1885/C3-R4 raccord boîte de vitesses Mazda
- 1885/C3-R5 raccord boîte de vitesses Renault Laguna-Esp
- 1885/C3-R6 raccord boîte de vitesses Nissan Juke
- 1885/C3-R7 raccord boîte de vitesses AISIN TF71 FV
- 1885/C3-R8 raccord boîte de vitesses AISIN TF71 FP
- 1885/C3-R9 raccord boîte de vitesses AISIN TF71 FO
- 1885/C3-R10 raccord boîte de vitesses AISIN TF71 FS



1885/C3 CHF 1,370.00 1 018850130

1885/C3-R1

Raccord boîte de vitesses DSG Mercedes pour 1885

Ic0191



1885/C3-R1 CHF 158.50 1 018850131

1885/C3-R2

Raccord boîte de vitesses POWERSHIFT pour 1885

Ic0190



1885/C3-R2 CHF 158.50 1 018850132

1885/C3-R3

Raccord boîte de vitesses Toyota IQ pour 1885

Ic0991



1885/C3-R3 CHF 158.50 1 018850133

1885/C3-R4

Raccord boîte de vitesses Mazda pour 1885



1885/C3-R4 CHF 158.50 1 018850134

1885/C3-R5

Raccord boîte de vitesses Renault Laguna-Esp pour 1885



1885/C3-R5 CHF 158.50 1 018850135

1885/C3-R6

Raccord boîte de vitesses Nissan Juke pour 1885

Ic02140



1885/C3-R6 CHF 158.50 1 018850136

1885/C3-R7

Raccord boîte de vitesses AISIN TF71 FV pour 1885

Ic01420



1885/C3-R7 CHF 158.50 1 018850137

1885/C3-R8

Raccord boîte de vitesses AISIN TF71 FP pour 1885

Ic001420/1



1885/C3-R8 CHF 158.50 1 018850138

1885/C3-R9

Raccord boîte de vitesses AISIN TF71 FO pour 1885

Ic001420/2



1885/C3-R9 CHF 158.50 1 018850139

1885/C3-R10

Raccord boîte de vitesses AISIN TF71 FS pour 1885

Ic001420/3



1885/C3-R10 CHF 158.50 1 018850140

1885/XC60

Raccord boîte de vitesses Volvo XC60 pour 1885



1885/XC60 CHF 170.50 1 018850151

1893/134A

Poste automatique de recharge des climatiseurs à gaz R134a

Modèle complètement automatique avec base de données auto/camions, avec quantité de gaz, quantité et type d'huile compresseur, logiciel d'auto-diagnostic pour opérations d'entretien ordinaire.

La base de données peut être mise à jour avec un logiciel. La machine peut travailler en modalité manuelle (avec supervision humaine phase par phase) ou en modalité complètement automatique (sans supervision).



R134A (250 ml)

CARACTÉRISTIQUES FONCTIONNELLES

Fonctionnement automatique
 Base de données auto/camions avec quantités de gaz, quantités et type d'huile compresseur
 Récupération automatique du gaz s'échappant du tuyau
 Compensation de la recharge de la quantité de gaz contenu dans les tuyaux
 Échappement automatique des gaz non condensables
 Indication automatique d'anomalies et maintenance
 Manomètres ø 80 mm
 Vacuomètre digital

CARACTÉRISTIQUES TECHNIQUES

Réservoir gaz : 15 kg
 Pompe à vide : 75 l/mn
 Balance électronique : 50 kg
 Carte électronique avec écran d'affichage rétroéclairé
 Vitesse de reprise : 500 t/mn
 Alimentation : 220 V

1893/134A CHF 8,060.00 1 018930001

1893/1234YF

Poste automatique de recharge des climatiseurs à gaz R1234yf

Modèle complètement automatique avec base de données auto/camions, avec quantité de gaz, quantité et type d'huile compresseur, logiciel d'auto-diagnostic pour opérations d'entretien ordinaire.

La base de données peut être mise à jour avec un logiciel. La machine peut travailler en mode manuel avec supervision humaine phase par phase ou en mode totalement automatique sans aucune supervision.



CE



1234YF (250 ml)

CARACTÉRISTIQUES FONCTIONNELLES

Fonctionnement automatique
Base de données auto/camions avec quantités de gaz, quantités et type d'huile compresseur
Récupération automatique du gaz s'échappant du tuyau
Compensation de la recharge de la quantité de gaz contenu dans les tuyaux
Échappement automatique des gaz non condensables
Indication automatique d'anomalies et maintenance
Manomètres ø 80 mm
Vacuomètre digital

CARACTÉRISTIQUES TECHNIQUES

Réservoir gaz : 15 kg
Pompe à vide : 75 l/mn
Balance électronique : 50 kg
Carte électronique avec écran d'affichage rétroéclairé
Vitesse de reprise : 500 t/mn
Alimentation : 220 V

1893/1234YF CHF 8,320.00 1 018930012

1893TR/134A

Traceur pour gaz R134a



1893TR/134A ml 250 CHF 56.50 1 018930901

1893TR/1234YF

Traceur pour gaz R1234yf



1893TR/1234YF ml 250 CHF 64.50 1 018930902

1893TR/CI

Traceur pour compresseurs hybrides



1893TR/CI ml 250 CHF 67.00 1 018930903

1895G

Générateur de commande pour injecteurs électroniques (essence et GPL) et électrovannes

Permet de tester en pleine autonomie l'efficacité de composants tels que :

- électrovannes EGR
- injecteurs électroniques de moteurs essence et GPL
- Électrovannes pour le réglage des turbines à géométrie variable
- compresseurs pour climatiseurs de nouvelle génération



CE

AVANTAGES

- Permet de comprendre si le composant est mécaniquement fonctionnant
- Avec les cuves à ultrasons, le nettoyage des composants commandé électroniquement est plus efficace pendant la phase de lavage

- Lors du contrôle des climatiseurs, il est indispensable pour établir l'efficacité du compresseur et de sa vanne de réglage

CARACTÉRISTIQUES TECHNIQUES

Commande injecteurs essence et GPL :
- nombre de sorties : 4
- durée du test : 1-60 s
- Temps d'ouverture : 5-10 ms
- Réglage fréquence percussion : 1-10 Hz
Commande dispositifs PWM :
- nombre de sorties : 1
- durée du test : 1-60 mn
- Automatique ou manuel
- Réglage duty cycle : 10%-85%
- Réglage fréquence signal : 120-250 Hz
Comprend 4 connecteurs avec terminaux faston femelle
Alimentation : 110-220 V
Dimensions : 334x240x74 mm
Poids : 4 kg

1895G CHF 2,405.00 1 018950800

1895/S

Support réglable pour cuves à ultrasons 1895

Permet le positionnement correct des injecteurs pendant la phase de lavage dans la cuve à ultrasons

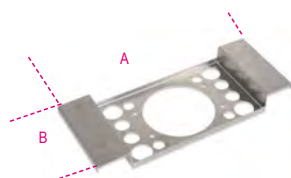

1895/S A mm 340 B mm 140 CHF 142.50 1 018950501

1895 6

Cuve de lavage à ultrasons de 6 litres

Avec fonction spéciale de dégazage



CE

- À travers le réchauffement du liquide et avec l'action des ultrasons, permet de nettoyer efficacement les pièces de rechange et les pièces métalliques en général (injecteurs, carburateurs, vannes etc.)
- Écran numérique avec réglage de la température et du temps de lavage
- Double fonction lavage: "soft" et "normal"
- Pour un nettoyage général, il suffit d'utiliser de l'eau à une température de 50/60 °C
- Pour un nettoyage plus méticuleux, ajouter des solutions détergentes non moussantes indiquées pour les cuves à ultrasons
- La fonction de dégazage accélère l'évacuation de l'air dans tout le volume de la cuve en augmentant l'efficacité des ultrasons

DONNÉES TECHNIQUES
Capacité cuve : 6 litres
Robinet de déchargement
Puissance : 150 Watt
Puissance de réchauffement : 300 Watt
Réglage température : 0+80 °C
Réglage temps de lavage : 0-99 minutes
Fréquence : 40 kHz
Alimentation : 220/230V
Dimensions : 330x180x310 mm
Dimensions réservoir : 300x155x150 mm
Dimensions panier : 250x105x100 mm
Poids : 6,7 kg

1895 6 Max 5,5 CHF 929.00 1 018950060

1895 13

Cuve de lavage à ultrasons de 13 litres

Avec fonction spéciale de dégazage



CE

- À travers le réchauffement du liquide et avec l'action des ultrasons, permet de nettoyer efficacement les pièces de rechange et les pièces métalliques en général (injecteurs, carburateurs, vannes etc.G9)
- Écran numérique avec réglage de la température et du temps de lavage
- Double fonction lavage : "soft" et "normal"
- Pour un nettoyage général, il suffit d'utiliser de l'eau à une température de 50/60 °C
- Pour un nettoyage plus méticuleux, ajouter des solutions détergentes non moussantes indiquées pour les cuves à ultrasons
- La fonction de dégazage accélère l'évacuation de l'air dans tout le volume de la cuve en augmentant l'efficacité des ultrasons

DONNÉES TECHNIQUES
Capacité cuve : 13 litres
Robinet de déchargement
Puissance : 300 Watt
Puissance de réchauffement : 400 Watt
Réglage température : 0+80 °C
Réglage temps de lavage : 0-99 minutes
Fréquence : 40 kHz
Alimentation : 220/230V
Dimensions : 350x325x320 mm
Dimensions réservoir : 325x235x145 mm
Dimensions panier : 257x185x100 mm
Poids : 10,5 kg

1895 13 Max 12 CHF 1,440.00 1 018950130

1895 27

Cuve de lavage à ultrasons de 27 litres

Avec fonction spéciale de dégazage



CE

- À travers le réchauffement du liquide et avec l'action des ultrasons, permet de nettoyer efficacement les pièces de rechange et les pièces métalliques en général (injecteurs, carburateurs, vannes etc.)
- Écran numérique avec réglage de la température et du temps de lavage
- Double fonction lavage: "soft" et "normal"
- Pour un nettoyage général, il suffit d'utiliser de l'eau à une température de 50/60 °C
- Pour un nettoyage plus profond, ajouter des solutions détergentes non moussantes spécialement pour cuves à ultrasons
- La fonction de dégazage accélère l'évacuation de l'air dans tout le volume de la cuve en augmentant l'efficacité des ultrasons

DONNÉES TECHNIQUES

Capacité cuve : 27 litres
 Robinet de déchargement
 Puissance : 500 Watt
 Puissance de réchauffement : 500 Watt
 Réglage température : 0-80 °C
 Réglage temps de lavage : 0-99 minutes
 Fréquence : 40 kHz
 Alimentation : 220/230V
 Dimensions : 530x330x380 mm

1895 27 25 **CHF** 2,000.00 1 018950270

1895/RC

Panier pour cuves à ultrasons 1895



	L	L1	A	CHF		
	mm	mm	mm			
1895/RC6	250	105	100	59.00	1	018950506
1895/RC13	257	185	100	93.00	1	018950513
1895/RC27	450	250	150	156.00	1	018950527

9881U



9881U 1 (1-2) 526
 9881U 1 (3) 526

9882R



9882R 1 (1-2) 526
 9882R 1 (3) 526

1897

Sableuse d'établi professionnelle

Particulièrement indiquée pour les opérations de finition superficielle de différents matériaux (métal, plastique, verre, céramique, bois etc.). La cabine est réalisée en tôle d'acier avec des renforcements pour garantir une grande robustesse et une bonne stabilité. La cabine est dotée de :

- porte de chargement avec fermeture à aimants
- plan en tôle perforée
- Coupleur standard pour aspirateurs Ø 36mm
- fenêtre de visualisation en polycarbonate de protection de 6 mm
- éclairage avec ampoule au LED
- circuit pneumatique (arrivée d'air comprimé)
- pistolet de sablage avec fonctionnement à gâchette



CE

DONNÉES TECHNIQUES

Dimensions utiles de la cabine : 600x520x320 mm
 Dimensions d'encombrement : 660x530x500 mm
 Poids : 38 kg
 Plan de travail : tôle perforée
 Éclairage : LED
 Consommation d'air : 340 l/mn à 7 atm
 Alimentation : 220 V - 50 Hz

1897 **CHF** 4,460.00 1 018970066

1897/CRB

Corindon pour sableuse 1897 en sac de 25 kg



1897/CRB **CHF** 224.00 1 018970101

1897/G

Garnet pour sableuse 1897 en sac de 25 kg



1897/G **CHF** 180.00 1 018970104

1897/MV

Microsphères en verre pour sableuse 1897 en sac de 25 kg



1897/MV **CHF** 296.00 1 018970103

1898/K40

Bac manuel pour le nettoyage de pièces mécaniques à recirculation avec liquide chauffé et bactéries

- Permet l'élimination des coûts d'écoulement pour solvants ou hydrocarbures ;
- en utilisant le détergent écologique Beta à base d'enzymes et bactéries, il permet l'élimination et l'écoulement des différents résidus de graisse présents sur les pièces mécaniques ;
- la fonction enzymatique aide à séparer la partie huileuse de la partie solide de saillure tandis que les bactéries transforment cette dernière en dioxyde de carbone et en eau, régénérant ainsi constamment le détergent.



CE

DOTÉ DE :

- brosse à soies longues et conduit de connexion ;
- prédisposition pour utilisation de la part des droitiers et des gauchers ;
- grille forcée en acier inox ;
- roues avec frein ;
- carte avec écran pour affichage de la température de fonctionnement et avertissement de niveau trop bas.

COMPREND :

- 2 bidons de liquide détergent respectueux de l'environnement de 20 litres et 2 paquets de bactéries.

DONNÉES TECHNIQUES

- Débit maximal de la pompe : 10 litres/minute
 - Capacité réservoir : 40 litres
 - Température de fonctionnement : +5 °C ÷ +40 °C
 - Dimensions : 900 x 1000 x 750 mm
 Poids : 50 kg à vide

1898/K40 **CHF** 5,940.00 1 018980004

ATTENTION

Pays où il est possible de distribuer le produit 1898/K40 : Autriche, Belgique, Espagne, France (à partir de 2021), Hongrie, Italie, Pays Bas, Pologne, Portugal, Royaume-Uni.

1898/B

Flacon de bactéries de 400 ml pour cuve de lavage des pièces 1898/K40



1898/B **CHF** 122.00 1 018980904

ATTENTION :

Pays où le produit 1898/B peut être distribué : Autriche, Belgique, France, Italie, Pays-Bas, Pologne, Portugal, Royaume-Uni, Espagne, Hongrie

1898/D

Jerrycane de liquide détergent éco-compatible de 20 litres pour cuve de lavage des pièces 1898/K40



1898/D CHF 243.00 1 018980920

ATTENTION :

Pays où le produit 1898/B peut être distribué : Autriche, Belgique, France, Italie, Pays-Bas, Pologne, Portugal, Royaume-Uni, Espagne, Hongrie

1898/M

Nébuliseur à pression avec réservoir de 2 litres

- Buse réglable pour jet linéaire ou nébulisé
- Échelle graduée de 0,5 l - 1 l - 1,5 l - 2 l
- Levier avec blocage pour jet continu
- Non utilisable avec des hydrocarbures



H mm 340 l 2 CHF 19.70 1 018980930

1898/S

Pompe manuelle à pression avec réservoir de 5 litres

- Lance en acier inoxydable
- Levier avec blocage pour jet continu
- Buse réglable pour jet linéaire ou nébulisé
- Sangle de transport confortable
- Poignée avec crochet pour la lance
- Tuyau flexible de 1,2 m
- Non utilisable avec des hydrocarbures



H mm 415 l 5 CHF 34.00 1 018980932

1899A

Machine de nettoyage du système DPF/FAP®

Des détergents spéciaux peuvent être utilisés périodiquement nettoyer et restaurer les systèmes DPF et FAP® endommagé par des dépôts de suie et de cendres.



Fourni avec:

- 1 tuyau d'alimentation de 2 m de long
 - 1 raccord rapide + buse de tuyau pour tuyaux de capteur différentiel
 - 1 nipler M18x1.5 avec buse de tuyau pour une connexion directe à la sonde lambda
 - 1 tuyau d'extension
 - 1 buse de pulvérisation DPF/FAP®
 - 1 support de tuyau magnétique
 - 1 tuyau DPF/FAP® avec presse-étoupe de réglage plus nipler M14/16/18 mm pour connecter des sondes lambda
- Caractéristiques techniques :
- tension de fonctionnement: 12 V
 - longueur du cordon d'alimentation: 3,9 m
 - capacité du réservoir: 1 l

1899A CHF 1,620.00 1 018990010

1899SI

Machine 2en1 pour le nettoyage des injecteurs et du collecteur d'aspiration

Grâce à l'utilisation de détergents prévus à cet effet, il est possible de nettoyer périodiquement les injecteurs et le collecteur d'aspiration des moteurs Diesel et essence, éliminant les dépôts de carbone et les résidus de combustion.



Caractéristiques techniques

- Tension de fonctionnement 12 V
- 2 tuyaux de service avec raccords rapides
- 2 réservoirs (capacité 1 l/chacun)

1899SI CHF 6,060.00 1 018990030

2080/VG

Étui à outils organisateur ABS avec plateaux pivotants

Avec organisateur supérieur de petites pièces (145 mm de diamètre) et 4 plateaux pivotants: - 1 plateau de 305 mm de diamètre - 3 plateaux de 445 mm de diamètre • Livré complet avec 12 cloisons pour une utilisation dans 3 plateaux pivotants plus grands, pour obtenir jusqu'à 8 compartiments par niveau



2080/VG CHF 222.00 1 020800100

445x445x550 mm - 3,4 kg

2250-0

Tabouret à roulettes réglable en hauteur



2250-0 CHF 140.50 1 022500011

2252

Siège mobile d'atelier



2252-G CHF 236.00 1 022520002

2252KR4

Roues de rechange siège mobile d'atelier 2252



2252KR4 CHF 79.50 1 022520900

Beta
Quality Tools

2258-0

Mini-servante tabouret à 3 tiroirs



2258-0 CHF 243.00 1 022580011

2254A

housses de voiture, pour une utilisation en extérieur, hydrofuge et résistant aux UV. Ces housses sont idéales pour protéger les véhicules endommagés en attendant d'être réparés.

Caractéristiques techniques

- finition extérieure avec traitement de protection UV
- finition intérieure douce et sans écaillement
- 6 cordes de réglage pour faire tenir le couvercle près de la voiture
- 2 fermetures éclair de porte avant pour permettre l'accès au véhicule sans avoir à retirer le couvercle
- sièges rétroviseurs
- réflecteur



3 versions :

- taille M recommandée pour les voitures compactes
- taille L recommandée pour les berlines et les breaks
- taille XL recommandée pour les VUS

	LxPxH mm	CHF		
/M	4400x1450 x1300	197.50	1	022540002
/L	5300x1450x1150	221.50	1	022540000
/XL	4700x1450x1580	202.50	1	022540001

2254C

Protection à ventouses pour carrosseries

En tissu plastifié avec 4 ventouses sur le côté supérieur



2254C CHF 64.50 1 022540200

2254F

Housse de protection avant

Permet de protéger la partie frontale du véhicule prévoyant les ouvertures pour les phares et le radiateur



- Imperméable
- Résistant aux huiles et aux graisses
- Fixation à l'aide de lacets
- Matériau : 98 % polyamide/nylon, 2 % polyuréthane

2254F CHF 110.50 1 022540150

2254K

Housse de protection réutilisable pour sièges, volant et pommeau du levier de vitesse

Apte à la plupart des sièges, volants et pommeaux des leviers de vitesse des véhicules



2254K CHF 38.00 1 022540101

2254SM

Tapis sous voiture en EVA

Double finition :

- 1 côté en souple EVA
- 1 côté en carbon look rigide pour favoriser le glissement



2254SM CHF 87.50 1 022540033

2254T

Tapis pour protection des genoux

Réalisé en EVA antidérapant



2254T CHF 38.50 1 022540047

3000L

Couchette d'atelier

- Coussin PVC épais garni de mousse caoutchouc pour un confort optimal.



3000L CHF 224.00 1 030000210

3000L/RLS

Roues de rechange couchette d'atelier



3000L/RLS CHF 16.30 6 030000212

3002

Couchette d'atelier et siège mobile

- Structure en acier
- Revêtement en PVC rembourré
- Possibilité de réglage rapide de la position : couchette d'atelier ou siège mobile



3002 CHF 148.00 1 030020001

3002/RLS

6 roues pour couchette d'atelier 3002



3002/RLS CHF 38.50 1 030020501

3003

Couchette d'atelier en plastique antichoc

- Ø roues : 76 mm



3003 CHF 115.50 1 030030001

3003/RLS

6 roues pour couchette d'atelier 3003



3003/RLS CHF 60.00 1 030030501

3003C

Couchette d'atelier en plastique antichoc

- Dotée de :
- coussin pour la tête et la zone lombaire avec finition en carbon look
 - plaques supérieures en métal pour la fixation d'accessoires magnétiques
 - 6 roues en caoutchouc avec diamètre 79 mm
 - portée max. 120 kg
 - poids 5,5 kg



3003C CHF 312.00 1 030030100

3003C/RLS

6 roues de rechange pour couchette d'atelier 3003C



3003C/RLS CHF 125.00 1 030030600

3003PRO

Couchette d'atelier en plastique antichoc

- Dotée de :
- coussin appui-tête ergonomique
 - protection souple pour le dos
 - 2 roues de 178 mm avec double coussin qui permettent l'utilisation même sur surfaces irrégulières et en présence de tubes/câbles
 - 1 roue pivotante
 - double réglage de la hauteur du sol : 38 ou 76 mm
 - 2 lampes à Led portables de 250 Lumens avec aimants pour fixation
 - capacité de charge : 200 kg
 - poids : 7,7 kg



C max	H min	H Max	H1	CHF	1	030030150
kg	mm	mm	mm	439.00	1	030030150
200	170	230	230			

3003PRO/SP

Support mural en plastique pour couchette d'atelier 3003PRO

Peut être appliqué sur un mur, un pont, une servante ou autre, permettant ainsi la fixation de la couchette d'atelier par le biais d'un système rapide et sûr avec fermeture de sécurité.



3003PRO/SP CHF 117.00 1 030030151

3003PRO/PM

Bac de rangement magnétique rond pour couchette d'atelier 3003PRO

En l'appliquant à la jante des roues de la couchette d'atelier, il permet de ne pas éparpiller la visserie pendant les interventions.



3003PRO/PM CHF 12.50 1 030030152

3003PRO/RCR

Paire de roues de rechange arrière pour couchette d'atelier 3003PRO



3003PRO/RCR CHF 93.00 1 030030650

3003PRO/RRG

Roue de rechange pivotante avant pour couchette d'atelier 3003PRO



3003PRO/RRG CHF 29.00 1 030030651

3003PRO/RT

lampe a LED avec aimants de rechange pour couchette d'atelier 3003PRO

- 250 lumens
- Piles : 4xAAA (non fournies)



3003PRO/RT CHF 21.10 1 030030652

3004

Cale de roue



3004	H mm	L mm	L1 mm	CHF	1	030040000
	225	475	200	43.50	1	030040000



Beta

REPARATION DE VEHICULES

Nos outils de réparation de véhicules qui sont utilisés par les professionnels les plus exigeants, sont développés et fabriqués pour répondre aux normes les plus élevées du monde, et régulièrement testés dans les conditions de fonctionnement les plus difficiles.

Depuis plus de 50 ans, nous travaillons fièrement et en collaboration les plus grands champions des sport mécaniques, nous aidant à améliorer continuellement nos produits et témoignant du niveau de qualité PREMIUM.

Les outils de réparations de véhicules se trouvent dans les sections:

Diagnostics	articles 1438 to 1499 articles 1758VT to 1760TMC
Moteur	articles 955 to 989A articles 1438 to 1499
Vidange	articles 1438 to 1499 articles 1877 to 1885
Système électrique	articles 1438 to 1499
Boosters de démarrage	articles 1498BC/12 to 1498/40A
Transmission	articles 1438 to 1499
Suspension	articles 1549 to 1569CP
Freins	articles 1438 to 1499
Roues	articles 955 to 989A
Carrosserie	articles 1302 to 1369 articles 1763 to 1767A
Autres équipements	articles 1878 to 3067
Levage	articles 3029/2T to 3067/70-13T



3006

Élévateur hydraulique pour le montage/démontage des roues de tracteurs et engins de chantier

- capacité maximum 1200 kg
- diamètre minimum roue 1000 mm
- diamètre maximum roue 2200 mm
- épaisseur maximum roue 800 mm

CE



3006 CHF 2,355.00 1 030060000

3006 R/RGF

Roue pivotante avec frein de recharge pour élévateur hydraulique pour le montage/démontage des roues 3006



3006 R/RGF CHF 90.50 1 030060501

3006 R/RG

Roue pivotante de recharge pour élévateur hydraulique pour le montage/démontage des roues 3006



3006 R/RG CHF 78.50 1 030060502

3007

Chariot de déplacement de véhicules sans roues

- Permet de déplacer facilement les véhicules accidentés ou en cours de réparation
- 4 roues pivotantes, dont 2 avec frein, adaptées à l'utilisation en cabines de peinture
 - 2 supports coulissants pour s'adapter à tous les châssis
 - capacité maximum 800 kg

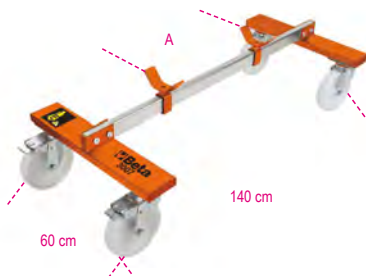

3007 A Max 110 mm CHF 825.00 1 030070001

3007 R/RGF

Roue pivotante avec frein de recharge pour chariot de déplacement des véhicules 3007



3007 R/RGF CHF 140.00 1 030070501

3007 R/RG

Roue pivotante de recharge pour chariot de déplacement des véhicules 3007



3007 R/RG CHF 122.00 1 030070502

3008

Élévateur hydraulique pour le montage/démontage des roues simples ou jumelées des poids-lourds

- capacité maximum 700 kg
- hauteur minimum 140 mm
- hauteur maximum 660 mm
- entraxe rouleaux 470÷740 mm
- sécurité hydraulique en cas de surcharge
- roues avant pivotantes

CE



3008 CHF 4,010.00 1 030080100

3009

Chariot de déplacement véhicules

- Capacité maximum : 550 kg
4 rouleaux basculants
Largeur rouleaux 200 mm
Pour roues jusqu'à 240 mm de large



A 400÷850 mm B 600 mm CHF 556.00 1 030090001

3009R/GR4

Groupe 4 roues chariots 3009 R/GR4



3009R/GR4	CHF		
	226.50	1	030090501

3010/T...

Paire de chandelles



C max	H min	H max	H1	L	L1
kg	mm	mm	mm	mm	mm
2000	280	425	245	185	165

3010T 2	CHF		
	131.00	1	030100002

C max	H min	H max	H1	L	L1
kg	mm	mm	mm	mm	mm
3000	285	430	250	180	195

3010T 3	CHF		
	155.00	1	030100003

C max	H min	H max	H1	L	L1
kg	mm	mm	mm	mm	mm
6000	400	580	340	245	280

3010T 6	CHF		
	225.00	1	030100006

C max	H min	H max	H1	L	L1
kg	mm	mm	mm	mm	mm
10000	471	735	420	330	290

3010T 10	CHF		
	388.00	1	030100010

3011/T

Crics bouteilles hydrauliques

CE



C max	H min	H Max	L
kg	mm	mm	mm
3500	170	366	86

3011T 3,5	CHF		
	131.00	1	030110035

C max	H min	H Max	L
kg	mm	mm	mm
5000	203	467	118

3011T 5	CHF		
	147.00	1	030110050

C max	H min	H Max	L
kg	mm	mm	mm
10000	220	484	114

3011T 10	CHF		
	219.50	1	030110100

C max	H min	H Max	L
kg	mm	mm	mm
15000	230	497	113

3011T 15	CHF		
	269.00	1	030110150

C max	H min	H Max	L
kg	mm	mm	mm
20.000	245	521	115

3011T 20	CHF		
	386.00	1	030110200

3010H

Chandelles série lourde



C Max	H min	H Max	L	L1
kg	mm	mm	mm	mm
15,000	445	631	300	300

3010H 750	CHF		
	420.00	1	030100150

C Max	H min	H Max	L	L1
kg	mm	mm	mm	mm
15,000	645	1077	300	300

3010H 1100	CHF		
	527.00	1	030100165

3010V

Chandelles série lourde avec réglage à vis



C Max	H min	H Max	L	L1
kg	mm	mm	mm	mm
20,000	410	600	330	330

3010V 680	CHF		
	611.00	1	030100200

C Max	H min	H max	L	L1
kg	mm	mm	mm	mm
20,000	665	1090	460	460

3010V 1170	CHF		
	777.00	1	030100220

3012

Barre support moteur



L	C max	CHF		
mm	kg			
1500	500	399.00	1	030120010
1800	400	542.00	1	030120018

3012C

Barre support moteur inférieure - grande amplitude

Idéale pour automobiles et véhicules utilitaires



3012C	CHF		
	1,055.00	1	030120255

3012I

Barre support moteur inférieure

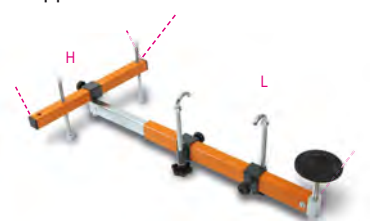

L	H	CHF		
mm	mm			
630=960	190	936.00	1	030120250

Beta

Beta
Quality Tools

3014

Chevalet de support moteur



3014 CHF 503.00 1 030140010

3014R/GR5

5 roues pour chevalet de support moteur 3014



3014R/GR5 CHF 126.00 1 030140501

3014 SAR

Chevalet pliable support moteur

- Facilement pliable pour un encombrement minimum
 - Permet une rotation de 360° du moteur ou de la transmission
 - Assure une sécurité e stabilité maximales lors des interventions
- Capacité maximum : 450 kg



3014SAR CHF 1,840.00 1 030140360

3014SAR/RR

4 roues pour chevalet de support moteur 3014SAR



3014SAR/RR CHF 202.00 1 030140370

3014SAR/1

Réservoir de collecte liquides pour 3014 SAR

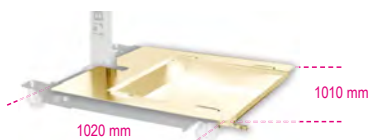

3014SAR/1 CHF 541.00 1 030140361
1020x1010x11 mm

3014SAR/2

Étrier pour fixation de la transmission sur chevalet 3014 SAR

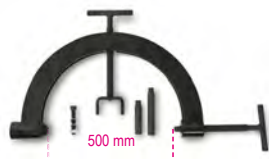

3014SAR/2 CHF 521.00 1 030140362

3023

étau télescopique avec réglage par vis

Capacité de charge maximale: 400 kg



3023 CHF 278.00 1 030230050
H min-Max mm 1350÷2030 Ø mm 300

3025

Grue hydraulique pliable avec pompe à double effet

Capacité maximum : 1 t



3025 CHF 2,500.00 1 030250001
H mm 1650 P mm 1560 L mm 1000 L1 mm 835

3025/RF

2 roues fixes pour grue hydraulique 3025



3025/RF CHF 320.00 1 030250901

3025/RG

2 roues pivotantes pour grue hydraulique 3025



3025/RG CHF 469.00 1 030250902

3025/PF

Pince de levage de fûts

Capacité maximum : 300 kg

CE



3025/PF CHF 398.00 1 030250011
A mm 550+640 B mm 70

3026 0,3

Vérin hydraulique de fosse et sous-pont 300kg

CE



3026 0,3 CHF 915.00 1 030260003
H min mm 1120 H Max mm 1970 L mm 450 L1 mm 450 Ø mm 25

3026/R0,3

4 roues pivotantes pour vérin hydraulique 3026 0,3



3026/R 0,3 CHF 230.50 1 030260903

3026 0,5

Verrins de fausse hydraulique de 500kg

Capacité maximum : 500 kg

CE



H min H Max L L1 Ø CHF 1,089.00 1 030260005

3026/R0,5

4 roues pivotantes pour vérin hydraulique 3026 0,5



3026/R 0,5 CHF 321.00 1 030260905

3026 1,0

Vérin hydraulique de fosse et sous-pont

Capacité maximum : 1 t

CE



H min H Max L L1 Ø CHF 1,315.00 1 030260010

3026/R 1,0

4 Roue pivotantes pour vérin hydraulique 3026 1,0



3026/R 1,0 CHF 414.00 1 030260910

3026/S

Support orientable pour transmissions avec boîtes chaudes de réduction pour vérins 3026

Capacité maximum : 500 kg

CE



3026/S CHF 766.00 1 030260501

3026/SP

Support universel orientable pour boîtes de vitesses

Permet à un seul opérateur de démonter et remonter les transmissions des voitures, des véhicules utilitaires et tout-terrain avec rapidité et sécurité.

CE



3026/SP CHF 892.00 1 030260505

3026/SA

Support moyeu roue pour vérins de fosse

• Utilisable pour les interventions de maintenance concernant les moyeux, et pendant les opérations de remplacement des amortisseurs
• Adaptable aux vérins hydrauliques de fosse 3026 0,3 et 3026 0,5



3026/SA CHF 186.00 1 030260510

3026/SAM

Support amortisseurs pour vérins de fosse

• Utilisable pour soutenir l'amortisseur au démontage du bras de la suspension
• Étrier pour amortisseurs avec diamètre max. 80 mm, plus réduction pour diamètres max. 60 mm
• Adaptable aux vérins hydrauliques de fosse 3026 0,3 et 3026 0,5



3026/SAM CHF 240.50 1 030260515

3027 10

Presse hydraulique de table avec piston mobile

Capacité maximum : 10 t

CE



3027 10 CHF 2,205.00 1 030270010
11 90 kg

3027 20

Presse hydraulique avec piston mobile de 20 tonnes

Capacité maximum : 20 t

CE



3027 20 CHF 3,060.00 1 030270020
11 131 kg

3027 30

Presse hydraulique avec piston mobile et treuil

Capacité maximum : 30 t

CE



3027 30 CHF 5,330.00 1 030270030
 📦 245 kg

3027 50

Presse hydraulique avec piston mobile et treuil

Capacité maximum : 50 t

CE



3027 50 CHF 7,290.00 1 030270050
 📦 368 kg

PRESSES

Beta propose une gamme complète de presses divisée en deux gammes :

- la série 3027 adaptée à un usage intensif grâce à des matériaux et des finitions de haute qualité
- la série 3028 caractérisée par un excellent rapport qualité/prix.

3027 100

presse électro-hydraulique motorisée avec piston mobile - 100 Tonnes

Spécifications techniques:

- capacité maximale: 100 Tonnes
- alimentation: 380 V (triphase)
- fréquence: 50 Hz
- puissance du moteur électrique: 1,5 kW
- unité de contrôle à double vitesse
- actionnement par un distributeur à levier
- levage de palettes au moyen de chaînes

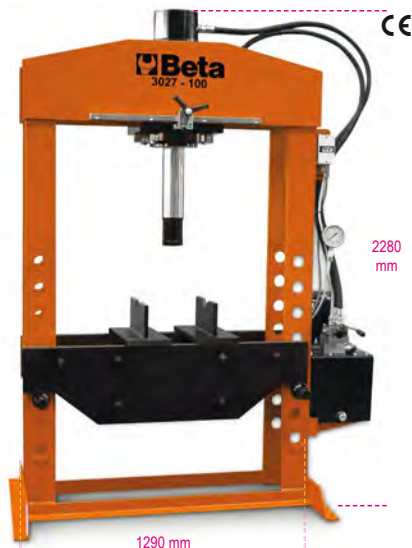

3027 100 CHF 21,700.00 1 030270100
 📦 980 kg

3027/KP

Jeu de chasse-goupilles et plaque pour presse 3027



		CHF		
3027/KP10	3027 10	494.00	1	030270510
3027/KP20	3027 20	658.00	1	030270520
3027/KP30	3027 30	658.00	1	030270530
3027/KP50	3027 50	775.00	1	030270550
3027/KP100	3027 100	1,390.00	1	030270551

3027/KPP50

Commande à pédale pour presse hydraulique 3027 20-30-50



3027/KPP50 CHF 327.00 1 030270555

3027/PR

Support universel de presse pour l'extraction ou l'introduction des moyeux, roulements et silent block

Système universel qui travaille sous presse à travers une base d'appui et accessoires annexes, permet le démontage/montage de moyeux, roulements et silent block de leur siège. L'outil s'adapte aux formes géométriques irrégulières des moyeux/ embouts fusionnés sur lesquels l'opérateur doit intervenir.



DONNÉES TECHNIQUES

Intervalle de travail : min. 130 mm - max. 186 mm
 Dimensions : 300 x 300 mm
 Poids : 13 kg
 Capacité maximum : 20 t

3027/PR CHF 820.00 1 030270400

3028 20

Presse hydraulique avec piston mobile

Capacité maximum : 20 t

Plateau réglable en hauteur
 Piston coulissant

CE

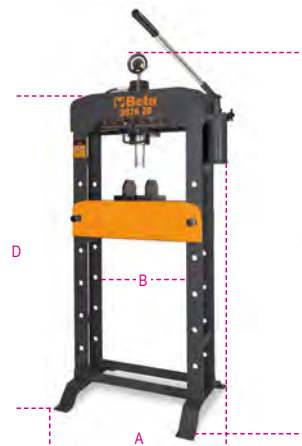

A mm	B mm	C mm	D mm	CHF		
850	540	1830	1602	1,970.00	1	030280020

3028SP/20

Écran de protection pour presses 3028 20



3028SP/20 CHF 220.50 1 030280021

3028 30

Presse hydraulique avec piston mobile

Capacité maximum : 30 t
Plateau réglable en hauteur
Piston coulissant

CE

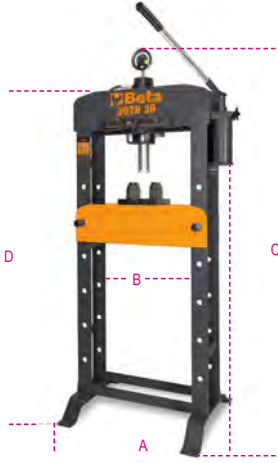

A	B	C	D	CHF		
850 mm	540 mm	1850 mm	1650 mm	2,750.00	1	030280030

3028SP/30

Écran de protection pour presses 3028 30



3028SP/30	CHF 220.50	1	030280031
-----------	------------	---	-----------

3028 50

Presse hydraulique avec piston mobile et treuil

Capacité maximum : 50 t
Plateau réglable en hauteur au moyen d'un treuil
Piston coulissant

CE

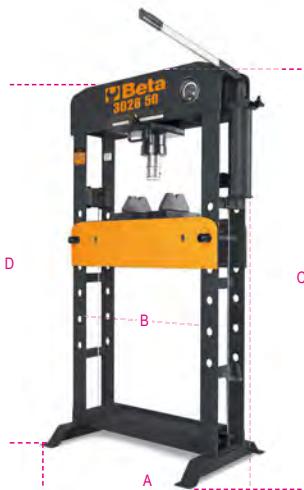

A	B	C	E	CHF		
1100 mm	750 mm	1850 mm	820 mm	4,810.00	1	030280050

3028SP/50

Écran de protection pour presses 3028 50



3028SP/50	CHF 233.50	1	030280051
-----------	------------	---	-----------

3029/2T

Cric rouleur hydraulique 2 t

- Pédale d'approche rapide
- Structure en acier et roues en nylon
- Hauteur minimum 75 mm

CE



3029/2T	CHF 552.00	1	030290020
---------	------------	---	-----------

3029L/2T

Cric rouleur hydraulique long 2 t

Permet d'intervenir sur les véhicules avec faible hauteur du sol et point de soulèvement interne

- Vitesse de descente contrôlée
- Pédale d'approche rapide
- Roues en nylon

CE



3029L/2T	CHF 639.00	1	030290120
----------	------------	---	-----------

3029/2T-L/RP

Plateau de recharge en caoutchouc 85 mm pour 3029/2T, 3029L/2T



3029/2T-L/RP	CHF 21.60	1	030290502
--------------	-----------	---	-----------

3029/2T-L/R6

Roue arrière pour 3029/2T, 3029L/2T, 3030H/2T, 3033E/3T



3029/2T-L/R6	CHF 70.00	1	030290506
--------------	-----------	---	-----------

3029/2T-L/R5

Roue avant pour cric 3029/2T, 3029L/2T



3029/2T-L/R5	CHF 65.00	1	030290505
--------------	-----------	---	-----------

3030/2T

Cric rouleur hydraulique à 6 roues

- Doubles roues avant basculantes en matière plastique (PTFE)
- Excellent manœuvrabilité du cric sur sols accidentés et irréguliers
- Charge utile maximum : 2 tonnes

CE



3030/2T	CHF 1,049.00	1	030300020
			43 kg

3030/2T-R5

Roue avant avec pivot pour cric rouleur 3030 2T



3030 2T/R5	CHF 36.50	1	030300505
------------	-----------	---	-----------

3030/2T-R6

Roue arrière pour 3030/2T



3030 2T/R6	CHF 57.00	1	030300506
------------	-----------	---	-----------

3030/2TRP

Plateau de recharge en caoutchouc 85 mm pour 3030/2T



3030/2TRP CHF 7.45 5 030300501

3030H/2T

Cric hydraulique à haute levée 6 roues, 2 Tonnes

Permet de travailler sur des véhicules en hauteur par rapport au sol et ayant une longue course d'amortisseur • vitesse de descente contrôlée

- pédale d'approche rapide
- roues en nylon

CE



H min-Max mm	L mm	L1 mm	CHF	1	030300220
85+780	1010	300	878.00	1	030300220

3033/3T

Vérin hydraulique 3 t version longue

- Pour utilisation sur véhicules commerciaux
- Capacité maximum : 3 t
- Roues en polyamide

CE



3033/3T CHF 1,385.00 1 030330030

3033E/3T

Cric hydraulique 4 roues, 3 Tonnes

- vitesse de descente contrôlée
- roues en nylon

CE



H min-Max mm	L mm	L1 mm	CHF	1	030330130
95+515	700	370	515.00	1	030330130

3033S 3T/R2

Roue avant de secours pour cric 3033E/3T



3033S 3T/R2 CHF 59.00 1 030330532

3035

chariot de transport pour pneumatique

- 2 roues Ø 260 mm
- 2 roues Ø 125 mm
- Hauteur maximum transportable 1,60 m
- Charge utile maxi 200 kg
- Fourches réglables en 2 positions : première position ouverture maximum 880 mm deuxième position ouverture maximum 980 mm



3035 CHF 1,265.00 1 030350100

3036

Base pour manipulation des roues

- Socle porte-pneus
- Roues en caoutchouc non marquantes



3036 CHF 149.50 1 030360063

3061/2T

Cric pneumatique 2 boudins - 2 tonnes

CE



Doté de :

- membrane triple épaisseur de grande résistance et guide télescopique interne
- dispositif d'arrêt en fin de course et soupape de sécurité pour charges excessives
- possibilité d'utilisation même sur leviers de soulèvement

DONNÉES TECHNIQUES

capacité : 2 t
poids : 14 kg
pression d'alimentation : 8-10 bars
hauteur : min.132 - max. 326 mm

3061/2T CHF 1,176.00 1 030610020

3061/2T-P50

Rallonge de 50 mm pour 3061/2T



3061/2T P50 CHF 100.00 1 030610021

3061/2T-P100

Rallonge de 100 mm pour 3061/2T



3061/2T P100 CHF 134.00 1 030610022

3065/20-10T

Cric hydro-pneumatique 20-10 t avec coffret de transport

Portable et léger, idéal pour les interventions d'assistance

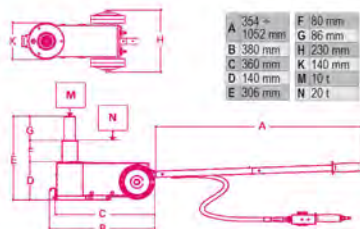

- Doté de 2 rallonges de 60 et 75 mm

DONNÉES TECHNIQUES

Capacité : 20-10 tonnes
Poids : 23 kg
Pression d'alimentation : 8-10 bar
Consommation d'air : 400 l/min

3065/20-10T CHF 3,470.00 1 030650100

3065/40-20T

Cric hydro-pneumatique 40/20 tonnes

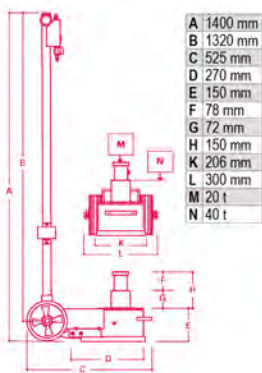

- indiqué pour utilisation sur poids-lourds
- pratique et maniable pour le transport, même dans des véhicules d'intervention
- retour automatique des pistons
- deux vannes de descente avec contrôle de la vitesse sous charge

DONNÉES TECHNIQUES

capacité : 40/20 tonnes
poids : 39 kg
pression d'alimentation : 8-10 bars
consommation d'air : 400 l/min

3065/40 20T CHF 3,940.00 1 030650200

3067/60-15T

Cric hydro-pneumatique 60-30-15 t

Avec une hauteur minimum de 120 mm seulement, il est particulièrement indiqué pour les interventions sur les autobus, les cars et tous les moyens de transport de ce type.

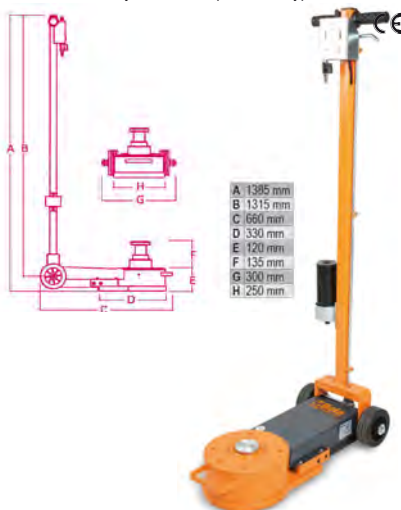

- Retour automatique des pistons
- Deux vannes de descente avec contrôle de vitesse sous charge
- Doté de deux rallonges de 70 et 120 mm

DONNÉES TECHNIQUES

Capacité : 60-30-15 tonnes
Poids : 56 kg
Pression d'alimentation : 8-10 bar
Consommation d'air : 600 l/min

3067/60-30-15T CHF 5,750.00 1 030670120

3067/70-13T

Cric hydro-pneumatique 70-43-23-13 tonnes

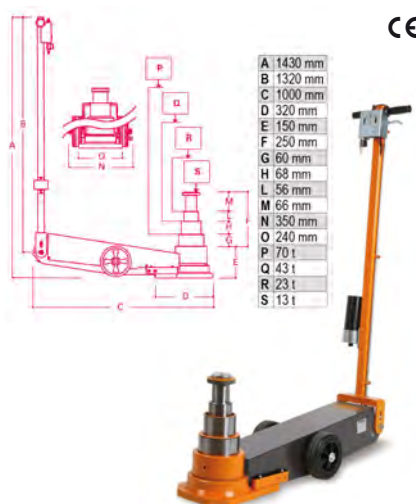

- Version longue, adaptée à l'utilisation sur camions, semi-remorques, autobus et machines agricoles
- retour automatique des pistons
- deux vannes de descente avec contrôle de vitesse sous charge

DONNÉES TECHNIQUES

capacité : 70-43-23-13 tonnes
poids : 74 kg
pression d'alimentation : 8-10 bars
consommation d'air : 600 l/min

3067/70 13T CHF 7,250.00 1 030670130

Beta



OUTILS POUR MOTORCYCLES

La qualité et la fiabilité des produits Beta sont garanties par plus de huit décennies d'expérience et de tradition.

Produits constamment mis à jour, dont la qualité est hautement appréciée par les techniciens des meilleures écuries de Moto GP, Mondial Superbike, Mondial Motocross et Enduro.



3040C

Chevalet arrière réglable pour motos



- Peinture noire mate
- 4 roues en caoutchouc thermoplastique
- Comprend paire de curseurs en V
- Comprend paire de curseurs en L



3040C CHF 103.00 1 030400002

3040C/S1

Paire de curseurs en V pour 3040C



3040C/S1 CHF 16.30 1 030400503

3040C/S2

Paire de curseurs en L en caoutchouc pour 3040C



3040C/S2 CHF 23.60 1 030400504

3041C

Chevalet avant réglable pour motos



- Peinture noire mate
- 4 roues en caoutchouc thermoplastique
- Comprend paire de curseurs à rouleaux
- Comprend paire de curseurs à cône



3041C CHF 96.00 1 030410002

3041C/12

Paire de curseurs à rouleaux pour 3041C



3041C/12 CHF 22.70 1 030410512

3041C/16

Paire de curseurs à cône pour 3041C



3041C/16 CHF 15.50 1 030410516

3042C

Chevalet avant pour fourreau de direction moto



- Peinture noire mate
- 4 roues en caoutchouc thermoplastique
- Comprend kit de 8 pivots Ø 13 - 15 - 15,5 - 17 - 19 - 20 - 21 - 27



3042C CHF 173.00 1 030420002

3043C

Chevalet pour moto avec monobras gauche



- Peinture noire mate
- 4 roues en caoutchouc thermoplastique
- Pivots en option



3043C CHF 126.50 1 030430002

3043C/ 41÷47

Pivot pour 3043C



	Ø mm	CHF		
3043C/41 Ducati	21,5 ÷ 25,5	29.00	1	030430551
3043C/42 KTM - Triumph	27,5	29.00	1	030430552
3043C/43 MV	42,5	31.50	1	030430553
3043C/44 Ducati	40,5	31.50	1	030430554
3043C/45 Honda	28,5	29.00	1	030430555
3043C/47 BMW	53,5	37.00	1	030430557

3047C

Béquille cross/enduro à pédale



3047C CHF 80.00 1 030470002

3048C

Béquille cross racing en acier



3048C CHF 80.00 1 030480002

3050/CC

Béquille centrale à vis sous berceau pour Custom, Enduro, Cross, Scooter



Comprend kit de supports réglables

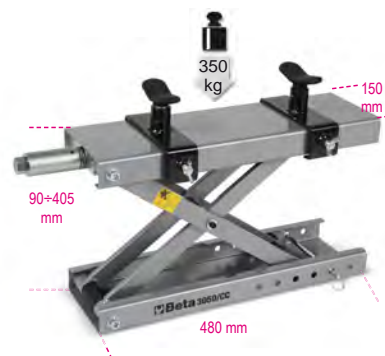

3050/CC CHF 208.50 1 030500012



3050/600

Élévateur moto électrohydraulique,
600 kg



CE



3050/O
3050/G
3050/R

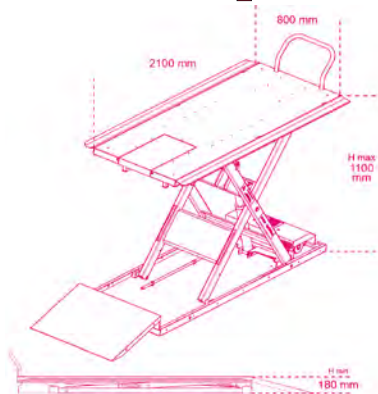

Caractéristiques techniques

- sécurités électriques, mécaniques et hydrauliques
- portée : 600 kg
- centrale électrohydraulique intégrée : 230V - 50 Hz
- pompe hydraulique
- vitesse de descente contrôlée
- fusibles de sécurité en cas de coupure du câble
- clavier de commande
- certifié CE homologué TÜV

	L	L	H min	H Max	CHF		
	mm	mm	mm	mm			
3050/O	975	2100	185	1110	7,020.00	1	030500201
3050/G	975	2100	185	1110	7,020.00	1	030500202
3050/R	975	2100	185	1110	7,020.00	1	030500203

3050/KA

Kit d'élargissement pour élévateur 3050/600

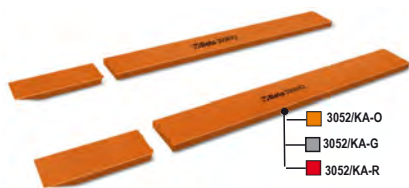

3052/KA-O
3052/KA-G
3052/KA-R

	A	B	CHF		
	mm	mm			
3050/KA-O	107,5	2100	1,405.00	1	030500221
3050/KA-G	107,5	2100	1,405.00	1	030500222
3050/KA-R	107,5	2100	1,405.00	1	030500223

3050/MS

Étau de roue autobloquant pour élévateur
3050/600



Permet le blocage de la roue avant de la moto sur le pont



3050/MS	CHF		
	799.00	1	030500032

3050/MV

Étau de roue autobloquant mécanique à vis
pour élévateur 3050/600



3050/MV	CHF		
	1,335.00	1	030500034

3050/LA

Plan en tôle antidérapante
pour élévateur 3050/600

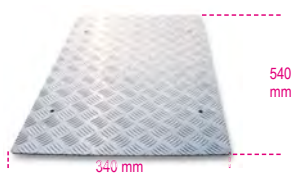

3050/LA	CHF		
	144.00	1	030500062

9562T1

garage mat, 100X80 cm



adapté à une utilisation sous les leviers de pneus moto BETA 3071 et 3071B

- fond recouvert de caoutchouc antidérapant facile à nettoyer



	L	H	CHF		
	cm	cm			
9562T1	100	80	110.50	1	095620150

9562T3

Tapis d'atelier

Dimensions : 300x160 cm

- Particulièrement indiqué pour l'utilisation sous les ponts élévateurs moto

- Protège le sol contre les fuites d'huile et d'essence et respecte l'environnement
- Facile à nettoyer, en caoutchouc et antidérapant



	L	H	CHF		
	cm	cm			
9562T3	300	160	438.00	1	095620300

3054

Base mobile pour chevalet central ou pour
roue arrière moto
avec extension pour chevalet latéral



3054	CHF		
	347.00	1	030540000

3055M

Étau automatique pour fourgons



Permet de fixer la roue avant
de la moto



3055M	CHF		
	132.50	1	030550002

3057

Rampe en aluminium pour chargement/
déchargement moto

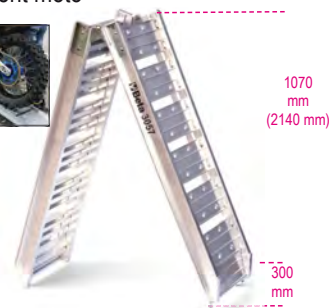

3057	CHF		
	282.00	1	030570001

3070B

Équilibreuse statique manuelle

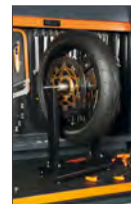

- permet l'équilibrage des roues dans l'atelier et les écuries
- dotée de paliers à roulement, niveau de positionnement et pieds réglables pour une précision optimale
- comprend un couple de cônes pour moyeux

3070B	CHF		
	165.50	1	030700100

3070B/...

tige d'équilibrage pour équilibreur 3070B



	Ø1	Ø2	CHF		
3070B/10	30	10	29.50	1	030700101
3070B/12	30	12	34.50	1	030700102
3070B/14	40	14	42.50	1	030700103

3070BE/K

Équilibreuse électronique portable à lancement manuel



Système d'équilibrage avec microprocesseur à lancement manuel (sans moteur) qui permet l'équilibrage de roues en fer ou en alliage d'autos et de motos.



- Compacte et facile à transporter, elle peut être utilisée en atelier, dans les fourgons ou dans les box des circuits ;
- peut être fixée sur un établi ou sur un mur ;
- le logiciel prévoit tous les programmes d'ajustement du déséquilibre avec indication des positions avec poids adhésifs (ALUS), poids dissimulés derrière les rayons (SPLIT) et optimisation du déséquilibre ;
- peut être utilisée avec support orientable BETA 3070BE/S (en option).

ACCESSOIRES INCLUS

- règle flexible graduée ;
- douille de serrage avec volant et 3 cônes de Ø 45 ÷ 110 mm

DONNÉES TECHNIQUES

Alimentation : 115-230V AC ou 12-24V DC
 Puissance maximale absorbée : 0,15 kW
 Vitesse d'équilibrage : 100 rpm
 Incertitude des mesures : 1 g
 Largeur jante réglable : 1,5" ÷ 20" (40 ÷ 510 mm)
 Poids maximal de la roue : max. 75 kg

	CHF		
3070BE/K	4,150.00	1	030700250

3070BE/S

Support orientable pour équilibreuse portable électronique 3070BE



Permet la fixation murale ou à l'établi de l'équilibreuse en réduisant l'encombrement et les espaces d'installation.



	L	L1	CHF		
3070BE/S	514	280	1,520.00	1	030700201

3070BE/F

Bride universelle motocycles Ø 40 mm pour 3070BE



Utilisable sur les roues avec trou central passant avec Ø de 15 à 35 mm et sur les roues bridées avec centrage jusqu'à Ø 68 mm.



	CHF		
3070BE/F	2,070.00	1	030700202

3070BE/B

Kit de 8 douilles pour le centrage des roues des motocycles pour 3070BE



Permet d'intervenir sur les Ø suivants : 28 - 25 - 22 - 20 - 19,05 - 17 - 16 - 15



	CHF		
3070BE/B	2,310.00	1	030700203

3071A

levier de pneu manuel pour motos cross et enduro



Permet un retrait facile et rapide des pneus dans les champs de course; basé sur un cadre robuste et large en acier galvanisé, il offre une fermeté lors du retrait des pneus. Peut être installé sur le support BETA 3071RS, pour plus de commodité

- Poignée ergonomique en caoutchouc, pour un maintien facile et sûr du levier
- Avec dispositif de retenue en caoutchouc pour verrouiller la tige pendant le transport
- Peut être utilisé pour installer des pneus cross et enduro, 17" ÷ 21"

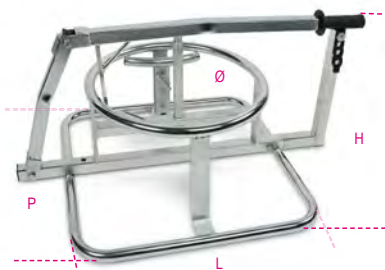

	L	H	P	Ø	CHF		
3071A	570	400	850	440	640.00	1	030710000

3071B

levier de pneu manuel pour mini vélos et mini motos tout-terrain



Permet un retrait facile et rapide des pneus dans les champs de course; basé sur un cadre robuste et large en acier galvanisé, il offre une fermeté lors du retrait des pneus. Peut être installé sur le support BETA 3071RS, pour plus de commodité

- Poignée ergonomique en caoutchouc, pour un maintien facile et sûr du levier
- Peut être utilisé pour installer la plupart des mini-vélos et mini pneus de vélo sales.

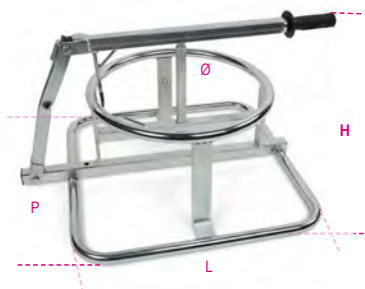

	L	H	P	Ø	CHF		
3071B	570	330	650	340	598.00	1	030710010

3071RS

Support pour leviers de pneus BETA 3071A et 3071B



pour élever les leviers de pneus BETA 3071A et 3071B, ce qui facilite le retrait des pneus; cadre en acier galvanisé, avec base carrée pour une fermeté accrue.

- Avec 4 crochets de fixation

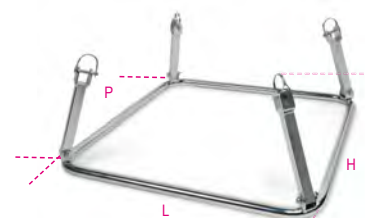

	L	H	P	CHF		
3071RS	670	275	670	278.00	1	030710020

962C

leviers de pneus, paire, pour les motos cross et enduro, les mini-motos et les mini motos sales



pour une utilisation en combinaison avec BETA 3071A et 3071B



	L	A	CHF		
962C	420	30	147.50	1	009620020

3072N

établi arrière moto amortisseur démonter, manuel

Permet le démontage totalement sûr de l'amortisseur arrière de la moto; basé sur ses bras réglables, il convient à la plupart des amortisseurs arrière; alternativement, il peut être utilisé avec la plaque fournie. - anneaux de verrouillage en option Fonctionnalités

- Convient pour une utilisation sur la plupart des amortisseurs arrière de moto
 - Réglable verticalement en 8 positions
 - 3 bras réglables avec dispositifs de retenue réglables verticalement
 - plaque de verrouillage de l'amortisseur
 - avec prise pantographe
 - avec pieds en caoutchouc
 - avec goupille de verrouillage de l'amortisseur
- Données techniques Extension jack: max. 130 mm Extension de bras: max. 55 mm Extension de retenue: max. 18 mm Poussée: max. 1 t



	L	H	P	CHF		
	mm	mm	mm			
3072N	390	785	390	1,445.00	1	030720010

3073

outil universel d'insertion de joints d'huile de fourche (joint spi)

Pour diamètres tige de 35 à 48 mm



	CHF		
3073	109.50	1	030730001

3075A

Douille six pans pour écrous moyeu roue



	Ø	Ø	L	CHF		
	mm	mm	mm			
3075A 28	28	38	30	36.00	1	030750028
3075A 30	30	40	30	38.50	1	030750030

3075B

Douille 12 pans pour écrou moyeu roue



	Ø	Ø	L	CHF		
	mm	mm	mm			
3075B 55	55	70,7	25	91.50	1	030750155

3075MV

Douille 12 pans pour écrous moyeu roue MV AGUSTA

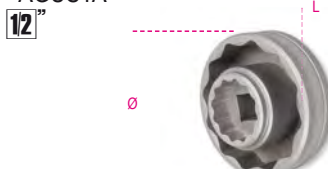

	Ø	Ø	L	CHF		
	mm	mm	mm			
3075MV 56	56	70,7	30	103.00	1	030750156

3075/CM

Clé mâle six pans multiple pour pivots roues



	CHF		
3075/CM	51.50	1	030750212
			12-14-17-19-22-24 mm

3075/K10

Set clé universelle à embout interchangeable avec 10 embouts, pour serrage des rayons de roues

Mesures : 5.2 - 5.4 - 5.6 - 5.8 - 6.0 - 6.2 - 6.4 - 6.6 - 6.8 - 7.0



	CHF		
3075/K10	69.00	1	030750410

3079/21

Huileur de câbles

Permet une lubrification correcte des câbles embrayage et commande gaz en augmentant le glissement des gaines et la durée des câbles.



	CHF		
3079/21	10.50	1	030790021

3080/C15

Kit rive/dérive chaînes

Ø 3-4-5 mm et kit Regina



	CHF		
3080/C15	459.00	1	030800015

420x185x60 mm

3080R/CS3

Kit de 3 chasse-goupilles pour dérive-chaîne 3080/C15

Ø 3-4-5 mm



	CHF		
3080R/CS3	70.50	1	030800503

3081

Dérive-chaîne portable

Robuste et pliable pour en faciliter le transport dans le sac d'enduro.

Adapté pour les chaînes 415, 420, 428, 520, 525, 530, 532



	CHF		
3081	57.00	1	030810010

3085

Outil pour séparation des pistons de frein

Indiqué pour les pinces de frein de moto et scooter



	CHF		
3085	126.50	1	030850010

3091

Extracteur avec filet interne pour volant-moteur



	M	CHF		
3091/10	24x1,5	26.50	1	030910010
3091/20	26x1,0	28.00	1	030910020
3091/25	27x1,0	28.00	1	030910025
3091/30	28x1,0	28.00	1	030910030
3091/40	30x1,0	38.00	1	030910040
3091/45	30x1,5	38.00	1	030910045
3091/50	32x1,5	41.50	1	030910050
3091/60	33x1,5	43.50	1	030910060
3091/70	35x1,0	60.50	1	030910070
3091/75	35x1,5	60.50	1	030910075
3091/80	38x1,5	66.50	1	030910080

3092

Extracteur avec filet externe pour volant-moteur



	M	CHF		
3092/10	18x1,5	14.10	1	030920010
3092/20	19x1,0	16.40	1	030920020
3092/25	27x1,0	17.10	1	030920025
3092/30	27x1,25/20x1	17.20	1	030920030
3092/35	22-26x1,5	17.20	1	030920035
3092/40	25x1,5/22x1	17.20	1	030920040
3092/50	26-28x1,0	17.20	1	030920050
3092/60	28x1,5	17.00	1	030920060

3093/E

Équipement pour le blocage du volant-moteur, la cloche d'embrayage et les poulies



	CHF		
3093/E	46.50	1	030930100

3093/U

Extracteur multiple pour volant-moteur



	CHF		
3093/U	45.00	1	030930050
M10x1.25R			
M14x1.5R			
M16x1.5R			
M18x1.5R			
M24x1.0R			
M27x1.0L			

3094PA

Panneau de service de dépannage de moto OFFROAD



Cadre métallique; les jambes peuvent être pliées en cadre; recommandé pour la disposition des outils dans les champs de course disponible en 3 couleurs :

- 3094PA-O Orange
- 3094PA-G Gris
- 3094PA-R Rouge Accessoires en option :
- porte-rouleau de papier 3200 PR
- porte-bouteille universel magnétique 2499PF/M



	L	H	H1	CHF		
	mm	mm	mm			
3094PA-O	750	1555	900	666.00	1	030940101
3094PA-G	750	1555	900	666.00	1	030940102
3094PA-R	750	1555	900	666.00	1	030940103

3095

Support de banc pour moteurs de moto



Grâce aux étriers réglables, les usinages sur les moteurs sont pratiques et aisés



	H	P	L	L1	CHF		
	mm	mm	mm	mm			
3095	360	460	640	460	751.00	1	030950001

3099E

Housse de moto d'extérieur, résistante à l'eau et à la poussière



protège la peinture des rayures, de la poussière et du soleil



Taille "M" recommandée pour les motos sportives et nues et les scooters de taille moyenne
Taille "L" recommandée pour les motos maxi, enduro et crossover

	M	CHF		
3099E/M	M	106.50	1	030990102
3099E/L	L	131.00	1	030990103

3099T

Housse de moto d'intérieur, en tissu extensible



protège la peinture des rayures, de la poussière et du soleil



Taille "M" recommandée pour les motos sportives et nues et les scooters de taille moyenne
Taille "L" recommandée pour les motos maxi, enduro et crossover
Taille "XL" recommandée pour les motos de super tourisme

	M	CHF		
3099T/M	M	92.50	1	030990202
3099T/L	L	113.00	1	030990203
3099T/XL	XL	137.00	1	030990204



Beta



OUTILS POUR VÉLOS

Beta est depuis toujours liée au cyclisme. Ce "Spécial Outils pour Vélos" est dédié aux professionnels du secteur et représente une sélection rigoureuse de produits spécifiques dédiés à l'entretien des vélos et des vélos électriques.



Tour de France 2020 and 2021



Partnership 2022

Official contributor
of Eolo KOMETA cycling



Partnership 2022



3910



Élévateur pour E-Bike

- Charge maximale : 40 kg
- Hauteur maximale du support de pédalier : 135 cm
- Centre de roue intégré
- Système de verrouillage innovant utilisant l'axe traversant
- Bagues d'adaptation fournies pour les principales fourches existantes
- Adaptateur pour fixation de fourche sans axe traversant inclus
- Entièrement pliable et transportable
- Poids de l'élevateur : 48 kg

CE

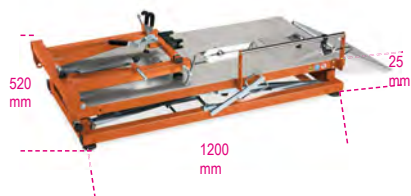

3910 CHF 4,590.00 1 039100010

3912TP



Établi d'atelier TOP pour l'entretien des vélos

- Avec support pour le mouvement central, avec goupille de sécurité
- Tiroir à outils avec glissières à roulement à billes (490x365x90 mm)
- Support de treillis de roue intégré
- Système innovant de verrouillage de l'essieu traversant



3912TP CHF 1,895.00 1 039120050

3912PP



Établi d'atelier PRO pour l'entretien des vélos

- Avec support pour le mouvement central, avec goupille de sécurité
- Support de treillis de roue intégré
- Système innovant de verrouillage de l'essieu traversant



3912PP CHF 1,033.00 1 039120150

3912TP/A



prise d'adaptateur pour fourches à essieu traversant

Pour les établis 3912TP, 3912PP et 3910



L mm 39 Ø mm 30 Ø1 mm 5 CHF 25.50 1 039120052

3912TP/C



doille d'adaptateur universelle pour fourches à essieu traversant, serrage de doille hexagonale

Pour les établis 3912TP, 3912PP et 3910



L mm 29 Ø mm 30 CHF 25.50 1 039120054

3912TP/FOX



doille pour fourches FOX®

Pour les établis 3912TP, 3912PP et 3910



L mm 38 CHF 25.50 1 039120058

3912TP/QRE



doille pour fourches sans essieux traversants

Pour les établis 3912TP, 3912PP et 3910



L mm 108 CHF 42.00 1 039120064

3912TP/ROAD



doille pour fourches routières

Pour les établis 3912TP, 3912PP et 3910



L mm 33 Ø mm 35 CHF 28.00 1 039120060

3912TP/RS



doille pour fourches ROCKSHOX® à essieu traversant

Pour les établis 3912TP, 3912PP et 3910



L mm 35 Ø mm 30 CHF 25.50 1 039120056

3912TP/ST



doille pour fourches SUNTOUR

Pour les établis 3912TP, 3912PP et 3910



L mm 31 Ø mm 30 Ø1 mm 18 CHF 28.00 1 039120062



3916MMP

pince monoface d'atelier pour l'entretien du vélo

- La pince peut être tournée à 360°, avec des mâchoires flottantes et un réglage micrométrique
- Capacité de charge: 25 kg
- Plateau à outils en plastique



3916MMP CHF 936.00 1 039160150

3918MML

Étau léger à un bras, pliable

- Étau rotatif à 360°
- Capacité : 15 kg
- Hauteur maximale de l'étau : 150 cm



3918MML CHF 381.00 1 039180010

3921

Outil pour l'alignement du dérailleur

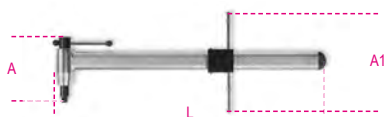

L mm 440 A mm 115 A1 mm 165 CHF 132.50 1 039210010

3923

Outil guide-lame pour découpe tige de selle de type aérodynamique jusqu'à 80 mm et découpe fourreaux de 1" à 1,1/2"

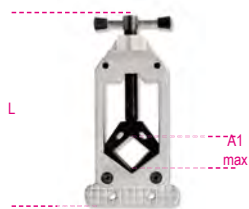

L mm 160 A1 max mm 80 Ø max mm 45 CHF 62.50 1 039230010

3927

Bloque-guidon



3927 L mm 365 CHF 38.00 1 039270010

3932U

Dérive-chaîne professionnel compatible avec chaînes de 5 à 11 vitesses



L mm 164 L1 mm 115 CHF 69.50 1 039320011

3935

Indicateur d'usure de la chaîne



L mm 120 CHF 11.90 1 039350010

3937

Pince pour fausse maille



L mm 170 CHF 30.50 1 039370010

3948

Extracteur pour manivelle

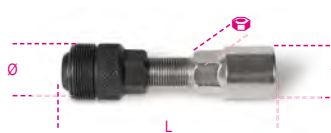

Ø mm 14 L mm 79 15 mm 15 CHF 23.70 1 039480015

3952

Clé conique simple



mm	L mm	CHF	1	039520013
13	205	30.50	2	039520013
14	205	30.50	2	039520015
15	205	30.50	2	039520015
16	205	30.50	2	039520016
17	205	30.50	2	039520017
18	205	30.50	2	039520018
19	205	30.50	2	039520019
20	205	31.00	1	039520020
21	205	31.00	1	039520021
22	205	31.00	1	039520022
24	205	32.00	1	039520024



3952/S7	CHF	1	039520207
13-14-15-16	214.50	1	039520207
17-18-19 mm			
3952/S11	340.00	1	039520211
13-14-15-16			
17-18-19-20-21-22-24 mm			

3953

Clé pour pédales



3953 L mm 401 CHF 47.00 1 039530015

3955

Clé à fourche pour jeux guidon universels



mm	L mm	CHF	1	039550108
30x32	292	44.00	1	039550108
32x36	319	48.50	1	039550114

3961 3,2

Clé à rayon noire 3,2 mm



3,2 mm CHF 17.20 1 039610032

3961 3,3

Clé à rayon verte 3,3 mm



3,3 mm CHF 17.20 1 039610033

39613,5

Clé à rayon rouge 3,5 mm



mm 3,5 CHF 17.20 1 039610035

3961U

Clé à rayon professionnelle 3,2 - 4,0 mm



mm 3,2 - 4,0 CHF 28.00 1 039610100

3962SH

Clé à rayon double pour Shimano



L mm 132 A1 mm 4,3 A2 mm 4,4 CHF 21.80 1 039620010

3962MV

Clé à rayon double pour Mavic



L mm 135 A1 mm 4,3 A2 mm 8,4 CHF 22.70 1 039620020

3963P

Clé spéciale pour rayons plats



L mm 129 CHF 10.40 1 039630010

3964

Clé spéciale de vissage des barrettes



L mm 170 L1 mm 89 CHF 25.50 1 039640010

3965

Gabarit pour carrossage roues de 20" à 29"



L mm 680 CHF 125.00 1 039650010

3965C

Centreur de roues professionnel



- Pour diamètres de 20" à 29"
- Adaptateur pour axes passants de 10 à 20 mm



L mm 500 L1 mm 380 A mm 285 CHF 506.00 1 039650110

3967

Clé fouet démonte-cassette



- Compatible jusqu'à boîtes à 11 vitesses
- Manche en 2PVC
- Adapté même aux roues à déclenchement fixe



L mm 289 CHF 69.00 1 039670010

3969

Levier démonte-pneus



L mm 200 A mm 15,6 CHF 12.50 1 039690010

3969K3

Jeu de 3 leviers démonte-pneus en plastique



L mm 113 CHF 6.95 1 039690130

3971

Clé pour vis en plastique Shimano



- Adapté aux garnitures Shimano Hollowtech II



N° 8 mm 8 CHF 15.40 1 039710010

3972

Clé extracteur pour mouvement central



- Apte pour Shimano® Hollowtech II, Campagnolo® Ultra-torque, FSA®, SRAM®



L mm 252 CHF 29.50 1 039720010

3973PF

Extracteur pour roulements Press-Fit



- Adapté aux Ø internes de 24 mm et 30 mm



L mm 240 CHF 39.50 1 039730001

3973/1

Douille extracteur pour mouvement central à 16 encoches



- Apte pour Shimano® XTR BB93, Dura-Ace® BB9000

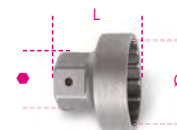

12" Ø mm 39 mm 24 L mm 34 CHF 25.50 1 039730010

3973/2

Douille extracteur pour mouvement central à 16 encoches



- Apte pour Shimano® BBR60 (Ultegra® 11 vitesses)

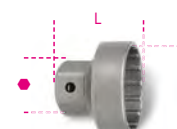

12" Ø mm 41 mm 24 L mm 35 CHF 25.50 1 039730020

3973/3

Douille extracteur pour mouvement central à 16 encoches

• Apte pour Shimano® Hollowtech II, Campagnolo® Ultra-torque, FSA®, SRAM®

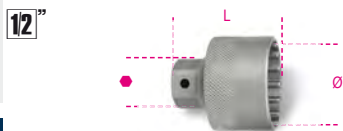

Ø int. mm 46
mm 24
L mm 53,5
CHF 25.50
1 039730030

3973/4

Douille extracteur pour mouvement central à 20 encoches avec pivot central, nickelée

• Apte pour Shimano et ISIS



Ø mm 31,5
L mm 55
mm 24
CHF 16.00
1 039730040

3975

Presse montage série guidon et mouvement central

• Adapté au montage des calottes série guidon de 1", 1.1/8", 1.1/4", 1.1/2" et 2"



L mm 360
Ø mm 16x1
CHF 336.00
1 039750010

3984/1

Clé extracteur pour roues libres BMX à 4 embouts

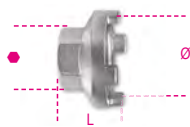

Ø mm 35
L mm 25,5
mm 24
CHF 18.70
1 039840010

3984/2

Clé extracteur pour roues libres Shimano



Ø mm 22,8
L mm 26
mm 24
CHF 11.90
1 039840020

3984/3

Clé extracteur pour roues libres Shimano à cassette avec embout de guide

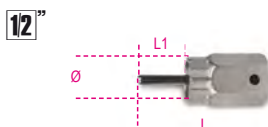

Ø mm 23,5
L mm 65
L1 mm 25
CHF 20.30
1 039840030

3984/4

Clé extracteur pour roues libres Campagnolo avec embout de guide



Ø mm 23
L mm 51
L1 mm 13
mm 24
CHF 26.50
1 039840040

3984/5

Clé extracteur pour roues libres à 2 embouts



Ø mm 18,5
L mm 38
mm 21
CHF 18.70
1 039840050

3984/6

Clé extracteur pour roues libres à 4 embouts



Ø mm 19,5
L mm 36
mm 21
CHF 18.70
1 039840060

3991

Levier pour écarter les pastilles des freins à disque



L mm 222
A mm 36
α 7°
CHF 44.50
1 039910010

3992

Clé pour redresser les disques des freins



L mm 234
mm 4
A1 mm 55
mm 2,2
CHF 33.50
1 039920010

Beta

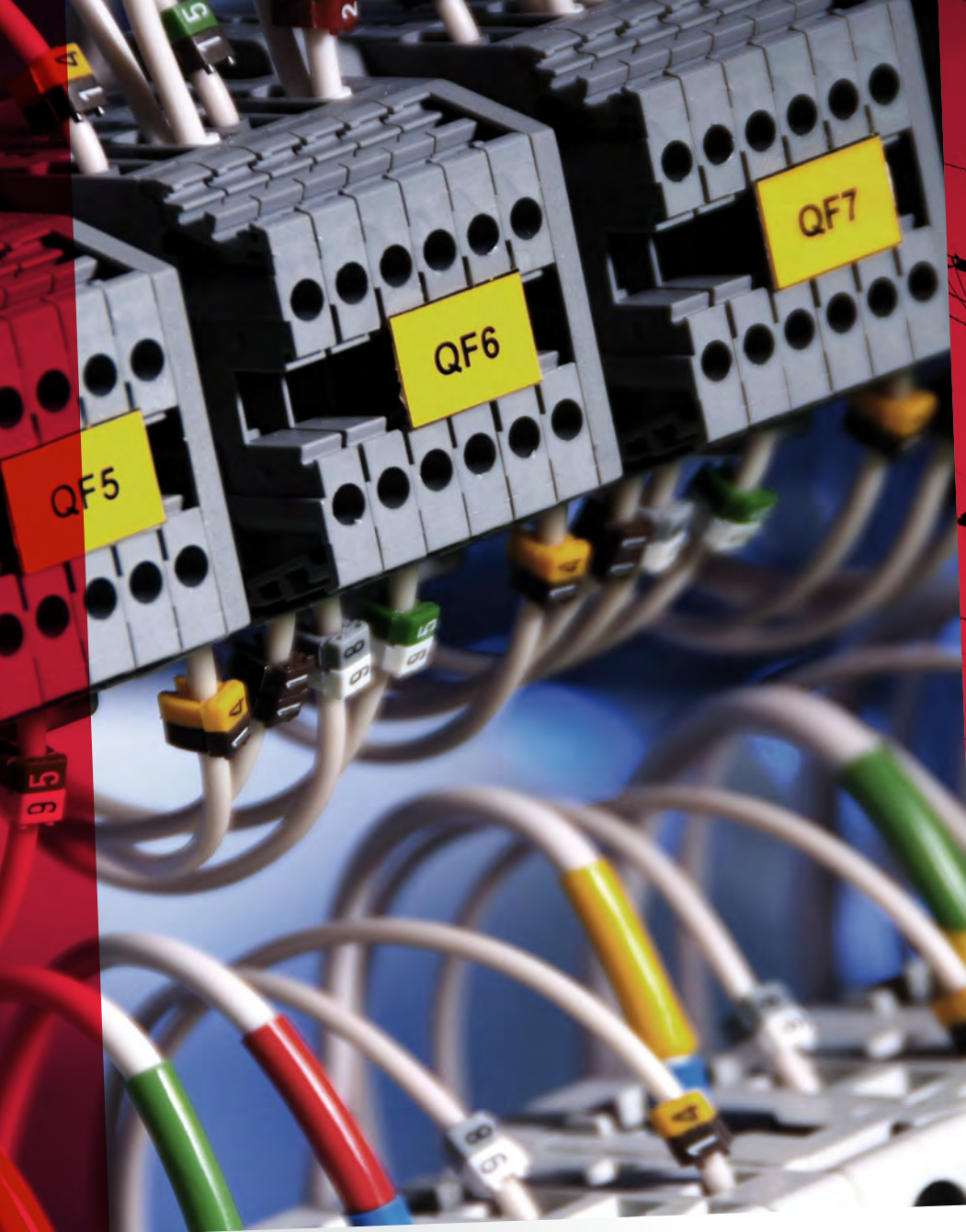

OUTILS ISOLÉS

Les outils isolés Beta sont des produits conçus pour garantir la sécurité des installateurs et des manutentionnaires électriques. Tous les outils isolés permettent d'intervenir sur les installations sous tension jusqu'à 1 000 V en courant alternatif et 1 500 V en courant continu.

Pour offrir ce qu'il y a de mieux en terme de qualité, de performance et pour vérifier et garantir la conformité aux normes EN 60900, chaque outil est soumis à un procédé de vérification poussé qui prévoit des essais de résistance de la poignée contre le défilage et la propagation de la flamme, et un essai de tension appliquée à 10 000 V.

Pour les compositions et les plateaux thermoformés, voir les sections correspondantes. Tous les outils isolés Beta sont construits conformément aux spécifications de la norme EN60900 et sont homologués par les meilleurs instituts européens de certification.



Istituto Italiano del Marchio di Qualità - I



Verband der Elektrotechnik
Elektroniker - D

1000 V

ESSAI DE SÉCURITÉ : testés à 10.000 volts pour travailler sur des installations à 1.000 volts.

Les outils à haut isolement Beta sont testés pièce par pièce à 10 kV dans le but d'offrir une qualité absolue pour des instruments de travail qui doivent garantir de très hauts standards de sécurité. Ils permettent en effet de travailler sur des installations sous tension jusqu'à 1000 V en courant alternatif (1500 V en courant continu).

NORMES DE SÉCURITÉ :

malgré les contrôles très poussés en phase de production, l'opérateur doit toujours vérifier, avant usage, l'absence de lacérations, de modifications ou de détériorations en tout genre de la branche isolante. La durée dans le temps des caractéristiques diélectriques est strictement liée aux stress mécaniques, chimiques ou thermiques qui peuvent être imposés à l'outil. En cas de détérioration de l'isolant, l'utilisation de cet outil pour les installations sous tension ne doit pas être considérée comme sûre. Utiliser systématiquement des lunettes et des gants isolés.

CONTRÔLES EFFECTUÉS EN PHASE DE PRODUCTION



Contrôle visuelle à 100 % :

tous les outils doivent présenter des finitions superficielles sans défauts visibles de l'extérieur.

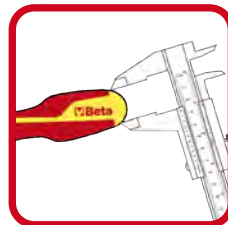

Contrôle dimensionnel :

toutes les paramètres des outils doivent être conformes aux spécifications techniques du projet.



Essai de choc :

après avoir laissé l'outil pendant 2 heures à une température de -25 °C, il est frappé trois fois (par un poids spécifique déterminé par la norme) et la branche isolante ne doit présenter aucun endommagement.

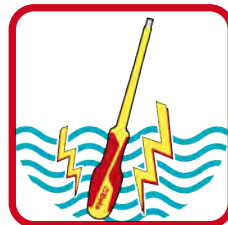

Essai d'isolation électrique :

après avoir immergé l'outil dans l'eau pendant 24 heures, une tension de 10 kV est appliquée pendant 3 minutes. Aucune dispersion de courant supérieure à celles prévues par la norme ne doit se produire.



Essai de pénétration :

un poids de 2 kg est appliqué pendant deux heures sur la branche de l'outil à +70 °C, puis dans la zone soumise à pression mécanique est appliquée une tension de 5 kV pendant trois minutes. Aucun passage de courant ne doit être relevé.

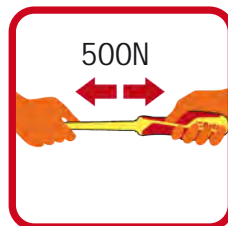

Essai d'adhérence :

après avoir laissé l'outil pendant 168 heures à +70 °C, une charge de 500 N lui est appliquée pour vérifier que la branche ne se défile pas.

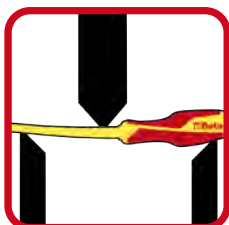

Essai mécanique :

les outils doivent satisfaire tous les critères des prestations mécaniques définis par les normes ISO respectives pour chaque produit



Essai d'indélébilité des marquages :

après l'essai de frottement avec de l'alcool isopropylique, les marquages doivent rester lisibles.



Essai de non-propagation de la flamme :

une flamme est orientée vers l'outil pendant 10 secondes. Lors des 20 secondes suivantes, la flamme ne doit pas dépasser 120 mm de hauteur.



52MQ

Clé à fourche



EN 60900

mm	L mm	CHF		
6	90	41.50	1	000520106
7	96	41.50	1	000520107
8	100	41.50	1	000520108
9	108	41.50	1	000520109
10	110	41.50	1	000520110
11	120	41.50	1	000520111
12	132	44.00	1	000520112
13	140	46.50	1	000520113
14	146	47.50	1	000520114
15	166	49.50	1	000520115
16	156	54.00	1	000520116
17	168	54.00	1	000520117
18	170	56.00	1	000520118
19	176	56.00	1	000520119
21	190	60.50	1	000520121
22	200	60.50	1	000520122
24	225	65.50	1	000520124
27	210	86.00	1	000520127
30	240	90.00	1	000520130
32	240	91.50	1	000520132

89MQ

Clé polygonale contre-coudée



EN 60900

mm	L mm	CHF		
6	150	53.50	1	000890106
7	155	53.50	1	000890107
8	155	53.50	1	000890108
9	160	53.50	1	000890109
10	170	53.50	1	000890110
11	180	53.50	1	000890111
12	190	58.00	1	000890112
13	195	62.00	1	000890113
14	200	65.50	1	000890114
15	210	67.00	1	000890115
16	216	71.50	1	000890116
17	218	71.50	1	000890117
18	236	76.00	1	000890118
19	240	76.00	1	000890119
21	250	87.50	1	000890121
22	255	87.50	1	000890122
24	280	98.50	1	000890124
27	300	104.50	1	000890127
30	320	123.50	1	000890130
32	340	125.00	1	000890132

110MQ

Clé à molette à ouverture graduée



EN 60900

L mm	A max	CHF		
200	28	106.50	1	001100520
250	30	123.50	1	001100525
300	30	180.00	1	001100530

606MQ/50

Clé dynamométrique à déclenchement avec cliquet réversible



EN 60900
UNI EN 26789
ISO 6789

Nm	Kgfm	lbf.ft	A mm	L mm	g
5÷50	0,5÷5	4÷40	90	375	1130

606MQ/50	CHF		
1	1,032.00	1	006060705

850MQ

Poignée porte-embouts magnétique isolée bimatières



IMQ CSV
EN 60900

L mm	L1 mm	D mm	CHF		
233	125	12.5	31.00	1	008500910

910MQ/B

Douille 12 pans



EN 60900

mm	L mm	Ø1 mm	Ø mm	CHF		
6	45	14	24	38.00	1	009100616
7	45	15	24	38.00	1	009100617
8	45	16	24	38.00	1	009100618
9	45	17	24	38.00	1	009100619
10	45	19	24	38.00	1	009100620
11	45	20	24	38.00	1	009100621
12	45	24	24	38.00	1	009100622
13	45	24	24	38.00	1	009100623
14	45	25	24	38.00	1	009100624
15	45	27	24	39.50	1	009100625
16	45	27,5	24	39.50	1	009100626
17	45	30	24	41.00	1	009100627
18	45	31	24	41.00	1	009100628
19	45	32	24	41.00	1	009100629

910MQ/PE

Douille tournevis pour vis 6 pans creux



EN 60900

mm	Ø mm	L mm	CHF		
4	24	100	42.50	1	009100604
5	24,5	100	42.50	1	009100605
6	25,0	100	42.50	1	009100606
8	25,0	100	42.50	1	009100608
10	25,5	100	44.00	1	009100610

910MQ/TX

Douille tournevis pour vis Torx®



EN 60900

mm	Ø mm	L mm	L1 mm	CHF		
15	23	116	61	54.00	1	009100641
20	24,5	116	65	54.00	1	009100642
25	24,5	116	65	54.00	1	009100643
27	24,5	116	65	54.00	1	009100644
30	24,5	116	65	55.00	1	009100645
40	24,5	116	65	56.00	1	009100646

910MQ/XZN

Douille tournevis pour vis XZN®



EN 60900

mm	Ø mm	L mm	L1 mm	CHF		
M8	24	106	57	50.00	1	009100658
M10	24	106	57	52.00	1	009100660

910MQ/PT

Rallonge pré-étalonnée carré femelle 3/8"



EN 60900

Nm	L mm	L1 mm	CHF		
12	80	35,5	285.00	1	009100801

910MQ/21

Rallonge carrés mâle et femelle 3/8"



EN 60900

L mm	Ø mm	CHF		
140	13,4	69.00	1	009100804

910MQ/22

Rallonge carrés mâle et femelle 3/8"



EN 60900

L mm	Ø mm	CHF		
265	13,4	75.00	1	009100805

910MQ/T

Poignée à béquille à cardan carré mâle 3/8"

3/8"



Δ 1000 V

EN 60900

L mm 200 L1 mm 165 CHF 82.00 Δ 1000 V 1 009100807

910MQ/55

Cliquet réversible carré mâle 3/8"

3/8"



Δ 1000 V

EN 60900

L mm 203 D mm 41 A mm 67 CHF 233.00 Δ 1000 V 1 009100808

910MQ/C16

Jeu 8 douilles 12 pans
Jeu 4 douilles tournevis pour vis 6 pans
et 4 accessoires

3/8"



Δ 1000 V

EN 60900

910MQ/C16 CHF 1,017.00 Δ 1000 V 1 009100917

- 910MQ/B 8 - 10 - 11 - 12 - 13 - 14 - 17 - 19 mm
- 910MQ/PE 4 - 5 - 6 - 8 mm
- 910MQ/21 125 mm
- 910MQ/22 250 mm
- 910MQ/T
- 910MQ/55

914MQ/A

Douille 6 pans,
carré femelle 3/8",
en technopolymères spéciaux sur base
polyamide
Spécifique pour intervenir sur les batteries de voitures
hybrides et électriques

Utiliser avec des clés dynamométriques

3/8"



Δ 1000 V

EN 60900

Ø mm	Ø mm	L mm	Ø1 mm	CHF		Δ 1000 V
8	17,5	45	20	19.70	2	009140008
10	20,5	45	20	19.70	2	009140010
13	24	45	20	19.70	2	009140013
17	30	45	22	19.70	2	009140017

3/8"



EN 60900

914MQ-A/S4 CHF 78.50 Δ 1000 V 1 009140054
8-10-13-17 mm

920MQ/A

Douille 6 pans

12"



Δ 1000 V

EN 60900

Ø mm	Ø mm	L mm	Ø1 mm	CHF		Δ 1000 V
8	21,5	57	27,5	38.00	1	009200238
9	21,5	57	27,5	38.00	1	009200239
10	21,5	57	27,5	38.00	1	009200240
11	21,5	57	27,5	38.00	1	009200241
12	23,0	57	27,5	38.00	1	009200242
13	23,0	57	27,5	38.00	1	009200243
14	23,0	57	27,5	39.00	1	009200244
16	23,0	57	27,5	39.50	1	009200246
17	30,0	57	27,5	39.50	1	009200247
18	32,0	57	27,5	41.00	1	009200248
19	32,2	57	27,5	41.00	1	009200249
20	32,0	57	27,5	46.00	1	009200250
21	34,0	57	27,5	46.00	1	009200251
22	36,0	57	27,5	46.00	1	009200252
24	39,0	57	27,5	47.00	1	009200254
27	42,0	57	27,5	47.50	1	009200257
30	44,0	57	27,5	49.50	1	009200260
32	48,0	57	27,5	51.00	1	009200262

920MQ/PE

Douille tournevis pour vis 6 pans creux

12"



Δ 1000 V

EN 60900

Ø mm	L mm	L1 mm	CHF		Δ 1000 V
*4	28,5	94,50	10,5	64.00	1 009200264
*5	28,5	94,5	10,5	64.00	1 009200265
*6	28,5	94,5	10,5	64.00	1 009200266
*8	28,5	94,5	10,5	64.00	1 009200268
10	28,5	94,5	10,5	66.50	1 009200267
12	28,5	94,5	10,5	66.50	1 009200269

920MQ/21

Rallonge carrés mâle et femelle 1/2"

12"



Δ 1000 V

EN 60900

L mm 135 Ø mm 28 CHF 73.00 Δ 1000 V 1 009200804

920MQ/22

Rallonge carrés mâle et femelle 1/2"

12"



Δ 1000 V

EN 60900

L mm 264 Ø mm 30 CHF 83.00 Δ 1000 V 1 009200805

920MQ/T

Poignée en T carré mâle 1/2"

12"



Δ 1000 V

EN 60900

L mm 200 L1 mm 163 CHF 87.50 Δ 1000 V 1 009200807

920MQ/55A

Cliquet réversible carré mâle 1/2"

12"

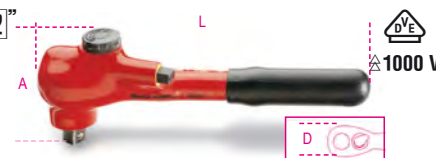

Δ 1000 V

EN 60900

L mm 240 D mm 50 A mm 89 CHF 311.00 Δ 1000 V 1 009200809

920MQ/C16

Jeu de 9 douilles 6 pans,
3 douilles tournevis pour vis 6 pans creux
et 4 accessoires

12"



Δ 1000 V

EN 60900

920MQ/C16 CHF 1,189.00 1 009200917

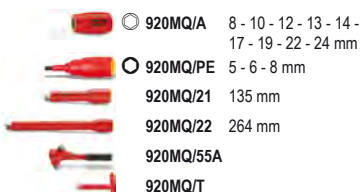

420x280x60 mm - 5,2 kg

943MQ

Clé à douille emmanchée



EN 60900

mm	L mm	L1 mm	D mm	CHF		
5,5	233	125	12,2	24.80	1	009430235
6	233	125	12,5	24.80	1	009430236
7	240	125	14,3	26.00	1	009430237
8	240	125	15,3	27.00	1	009430238
10	252	125	17,3	28.00	1	009430240
13	252	125	21,3	30.50	1	009430243

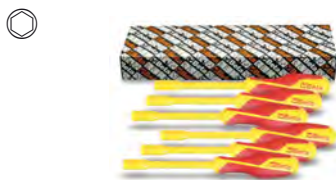

943MQ/S6 CHF 162.00 1 009430250
5,5-6-7-8-10-13 mm

951MQ

Clé mâle 6 pans en T

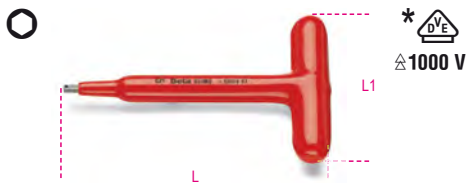

EN 60900

mm	L mm	L1 mm	CHF		
3	120	105	62.00	1	009510703
* 4	165	105	64.00	1	009510704
* 5	170	105	64.00	1	009510705
* 6	168	105	64.00	1	009510706
* 8	165	105	65.00	1	009510708
10	200	105	67.50	1	009510710

993MQ

Bruclles à becs coudés



EN 60900

L mm 147 CHF 52.00 1 009930040

994MQ

Bruclles à becs droits arrondis



EN 60900

L mm 145 CHF 51.00 1 009940040

1010MQ

Pince à becs ronds long



EN 60900

L mm 160 L1 mm 51,5 CHF 62.50 1 010100096

1048MQ

Pince multiprise entrepassée

• Finition chrome



EN60900

L mm 250 A max mm 48 L1 mm 39 CHF 92.50 1 010480315

1082MQ

Pince coupante diagonale



EN 60900

L mm 140 L1 mm 20 mm 1,6 CHF 62.00 1 010820094
160 22 1,6 65.00 1 010820096

1084MQ

Pince coupante diagonale
à faible effort de coupe



EN 60900

L mm 200 L1 mm 26 mm 2,0 CHF 82.00 1 010840100

1088MQ

Pince coupante frontale



EN 60900

L mm 160 L1 mm 7 mm 1,6 CHF 77.50 1 010880096

2115P L-MQ32



2115PL-MQ32

350

1128MQ

Ciseaux d'électriciens
lames en acier inoxydable
avec micro-denture



IEC60900

L mm 145 L1 mm 45 CHF 64.50 1 011280101

1132MQ

Coupe-câbles avec branches isolées
pour couper les câbles en cuivre et aluminium



EN 60900

L mm 230 mm 18 CHF 119.00 1 011320193

1142MQ

Pince à dénuder



EN 60900

L mm	mm ²	CHF	1	011420096
160	0,5÷6	69.00		

1150MQ

Pince universelle chromée polie



EN 60900

L mm	L1 mm	mm	CHF	1	011500096
160	37	1,6	59.00		
180	39	1,8	64.50		011500098
200	43	2,0	67.50		011500100
220	46	2,0	73.50		011500102

1162MQ

Pince à becs plats longs striés



EN 60900

L mm	L1 mm	mm	CHF	1	011620096
160	56	1,6	64.00		
200	76	1,6	67.50		011620100

1164MQ

Pince à becs coulés plats longs



EN 60900

L mm	L1 mm	mm	CHF	1	011640096
160	54	1,6	66.50		
200	76	1,6	70.00		011640100

1166MQ

Pince à becs demi-ronds longs striés



EN 60900

L mm	L1 mm	mm	CHF	1	011660096
160	56	1,6	64.00		
200	76	1,6	67.50		011660100

1168MQ

Pince à becs coulés demi-ronds longs striés



EN 60900

L mm	L1 mm	mm	CHF	1	011680096
160	50	1,6	66.50		
200	70	1,6	70.00		011680100

1272MQF

pour vis cruciformes à tête Phillips®

Slim

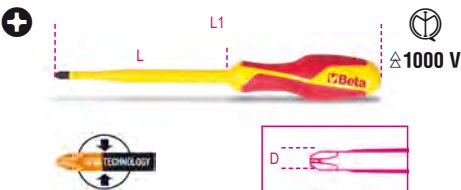

EN 60900

PHxDxL mm	L1 mm	CHF	3	012720609
1x4,5x80	187	18.60		
2x6x100	218	21.10		012720618

1272MQ

Tournevis pour vis Phillips®



EN 60900

PHxDxL mm	L1 mm	CHF	3	012720703
0x3x60	160	12.50		
1x4,5x80	187	15.40		012720709
2x6x100	218	17.60		012720718
3x8x150	276	22.70		012720724
4x10x200	326	27.00		012720727



EN 60900

PHxDxL mm	CHF	1	012720751
1272MQ/S5	95.50		

PH0x3x60-PH1x4,5x80
PH2x6x100-PH3x8x150
PH4x10x200 mm



1273MQF/D...

Jeu de 6 tournevis isolé 1000V "slim"



EN 60900

1273MQF/D4	CHF	1	012730604
1272MQF	74.50		
1274MQF			

1x4,5x80-2x6x100 mm
0,6x3,5x100-1x5,5x125 mm

1273MQF/D6	CHF	1	012730606
1272MQF	114.50		
1274MQF			

1x4,5x80-2x6x100 mm
0,6x3,5x100-1x4,5x100-1x5,5x125-1,2x6,5x150 mm

1273MQ/D6

Jeu de 6 tournevis



EN 60900

1273MQ/D6	CHF	1	012730851
1274MQ	89.00		
1272MQ			

0,5x3x100 -0,8x4x100
1,0x5,5x125 mm
PH0x3x60 -PH1x4,5x80
PH2x6x100 mm

1274MQF

Tournevis pour vis à fentes sans tête

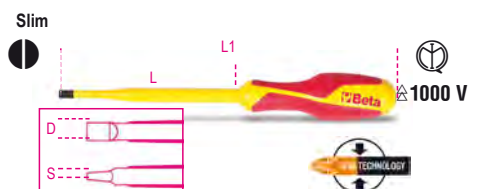

EN 60900

SxDxL mm	L1 mm	CHF	3	012740603
0.6x3.5x100	200	16.00		
1x4.5x100	205	17.90		012740606
1x5.5x125	232	18.70		012740609
1.2x6.5x150	268	22.50		012740612

1274MQ

Tournevis à lame fraisée pour vis à fente

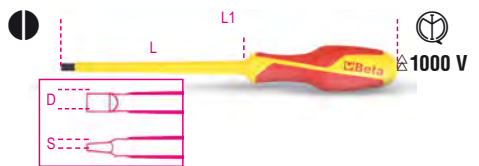

EN 60900

SxDxL mm	L1 mm	CHF	3	012740700
0,4x2,5x75	175	12.20		
0,5x3x100	200	12.80		012740703
0,8x4x100	207	15.10		012740706
1x5,5x125	232	16.10		012740709
1,2x6,5x150	268	19.50		012740712
1,2x8x175	301	22.70		012740715
1,6x10x200	326	27.00		012740718



1274MQ/S6

CHF 113.00

1 012740751

0,5x3x100-0,8x4x100
1x5,5x125-1,2x6,5x150
1,2x8x175-1,6x10x200 mm

1275MQ/C

Tournevis pour vis cruciformes combinées PH + à fente

Slim



EN60900

	CHF		
PH1+LPP	17.20	2	012750409
PH2+LPP	19.50	2	012750418

1276MQ/C

Tournevis pour vis cruciformes combinées PZ + à fente

Slim



EN 60900

	CHF		
PZ1+LPP	16.30	2	012760409
PZ2+LPP	18.40	2	012760418

1279MQ/F

Tournevis pour vis Pozidriv®-Supadriv®

Slim



EN60900

pz	L mm	L1 mm	CHF		
1	80	187	17.20	3	012790409
2	100	218	19.50	3	012790418

1279MQ

Tournevis pour vis Pozidriv®-Supadriv®



EN 60900

PZ	L mm	L1 mm	CHF		
0	60	160	12.90	3	012790703
1	80	187	15.60	3	012790709
2	100	218	18.00	3	012790718
3	150	276	23.70	2	012790724



1279MQ/S4
PZ 0-1-2-3

CHF 70.00

1 012790751

1725MQ

Mini-scie



EN 60900

1725MQ	L mm	H mm	CHF		
	260	85	119.00	1	017250030

1777MQ/C

Couteau d'électricien avec dénudeur isolé

• pour câbles multipolaires



EN 60900

1777MQ/C	L mm	CHF		
	190	47.50	1	017770026

1777MQ/U

Couteau d'électricien avec dénudeur isolé



EN 60900

1777MQ/U	L mm	CHF		
	190	43.50	1	017770011

1777RL/U

4 lame de rechange pour 1777MQ/U



1777RL/U

CHF 34.00

1 017770021

1995MQ/T

Tapis isolant

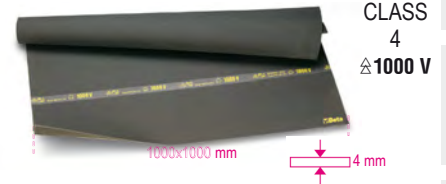

VDE 0303
EN 60243

1995MQ/T	LxSxH mm	CHF		
	1000x1000	398.00	1	019950030

1995MQ/G1 - G2

Gants isolants en latex

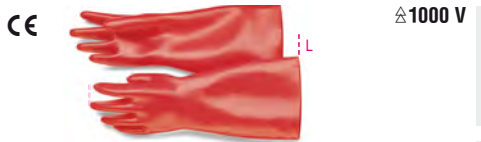

EN 60903

1995MQ/G1	Gr.	L mm	CHF		
	9	410	158.50	1	019950010
1995MQ/G2	10	410	158.50	1	019950013

1996MQ/T

Bâche isolante

500x500mm

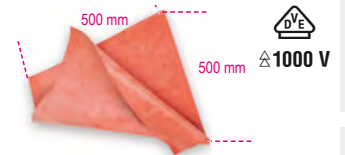

DIN EN 61112

S mm	CHF		
1.0	121.00	1	019960005

1996MQ/GM

Gants isolants composites

EN60903
EN388



EN 60903
EN 61482

1996MQ/GM 9	Gr.	L mm	CHF		
	9	410	204.00	1	019960109
1996MQ/GM 10	10	410	204.00	1	019960110

1996SVG

Instrument pour la vérification pneumatique des gants isolés

Obligatoire pour la EN90603



1996SVG

CHF 466.00

1 019960133



OUTILS ANTI-CHUTE

Beta H-SAFE

La gamme des outils H-SAFE de Beta comprend plus de 200 références. Un système de retenue différent a donc été conçu selon les outils afin de résister aux sollicitations mécaniques les plus sévères et pour assurer une garantie de sécurité maximum.

De même, le confort d'utilisation ne doit pas être négligé. En effet, les outils présentant deux parties actives, comme les clés de serrage réf. 42, sont attachés par un câble en acier qui coulisse le long du corps de l'outil tandis que les outils utilisés en torsion, par exemple les tournevis sont attachés par des anneaux à rotation libre pour ne pas torsader le cordon de retenue.





Le système de retenue H-SAFE a été conçu, testé et produit dans les établissements Beta. Grâce au système de sécurité H-SAFE de Beta, les outils sont toujours à portée de main, de manière confortable et sûre



35HS

Burin nervuré H-SAFE





L mm	A mm	CHF		
200	23,0	51.00	1	000354004
250	28,5	64.00	1	000354005

42HS

Clé mixte H-SAFE





DIN 3113 UNI-ISO 7738

	L mm	CHF		
6x6	95	26.00	1	000424506
7x7	105	26.50	1	000424507
8x8	116	26.50	1	000424508
9x9	127	27.50	1	000424509
10x10	137	28.00	1	000424510
11x11	148	28.50	1	000424511
12x12	158	29.00	1	000424512
13x13	169	29.00	1	000424513
14x14	180	30.50	1	000424514
15x15	190	30.50	1	000424515
16x16	201	31.50	1	000424516
17x17	212	33.50	1	000424517
18x18	222	34.00	1	000424518
19x19	233	34.50	1	000424519
20x20	243	36.00	1	000424520
21x21	254	38.00	1	000424521
22x22	264	39.00	1	000424522
23x23	275	41.00	1	000424523
24x24	285	42.50	1	000424524
25x25	296	42.50	1	000424525
26x26	307	44.00	1	000424526
27x27	317	47.00	1	000424527
28x28	328	47.50	1	000424528
29x29	338	52.50	1	000424529
30x30	349	54.50	1	000424530
32x32	370	60.00	1	000424532
34x34	391	98.50	1	000424534
36x36	412	108.50	1	000424536

42HS/AS

Clé mixte H-SAFE



	L mm	CHF		
1/4x1/4	95	28.00	1	000424106
5/16x5/16	116	28.50	1	000424108
3/8x3/8	137	30.00	1	000424110
7/16x7/16	148	31.00	1	000424111
1/2x1/2	169	31.00	1	000424113
9/16x9/16	180	31.50	1	000424114
5/8x5/8	201	34.00	1	000424116
11/16x11/16	212	36.00	1	000424117
3/4x3/4	233	38.00	1	000424119
13/16x13/16	254	42.00	1	000424121
7/8x7/8	264	42.50	1	000424122

Ø	L mm	CHF	🔧	📄
15/16x15/16	285	47.00	1	000424124
1x1	296	48.50	1	000424125
1.1/16x1.1/16	317	53.50	1	000424127
1.1/8x1.1/8	338	56.50	1	000424129
1.1/4x1.1/4	370	67.00	1	000424132
1.5/16x1.5/16	391	101.50	1	000424133

55HS

Clé à fourches H-SAFE



UNI-ISO 10102 DIN 3110

Ø	L mm	CHF	🔧	📄
• 6x7	120	21.00	1	000554012
• 8x9	140	21.50	1	000554021
• 10x11	155	21.80	1	000554030
• 12x13	170	23.70	1	000554042
• 14x15	185	24.30	1	000554054
• 16x17	202	26.00	1	000554060
• 18x19	220	27.50	1	000554066
• 20x22	236	29.00	1	000554075
• 21x23	245	30.50	1	000554078
• 22x24	245	33.00	1	000554081
• 24x27	262	36.00	1	000554090
• 30x32	297	44.50	1	000554108
• 34x36	325	100.50	1	000554117

91HS-C

Clé polygonale contre-coudée gros effort H-SAFE



Ø	Ø	CHF	🔧	📄
mm	mm			
36	54	122.50	1	000914036
41	62	143.00	1	000914041
46	69	166.00	1	000914046

91HS

Clé polygonale contre-coudée gros effort H-SAFE



Ø	Ø	CHF	🔧	📄
mm	mm			
36	54	245.00	1	000914236
41	62	265.00	1	000914241
46	69	312.00	1	000914246

92HS

Manche tubulaire pour 91 H-SAFE



L mm	91 mm	Ø mm	CHF	🔧	📄
610	32+41	22	122.00	1	000924020
760	46+55	25	147.00	1	000924030

93HS

Clé polygonale pour échafaudage H-SAFE



Ø	L mm	CHF	🔧	📄
21x22	310	70.50	1	000934021

96TBP-HS

Clé mâle 6 pans coudée à tête sphérique et à poignée en T, équipée du système de retenue antichute H-SAFE



Ø	L mm	L1 mm	Ø	CHF	🔧	📄
2,5	153	55	4	33.50	1	000964685
3	153	55	4	34.50	1	000964686
4	179	70	5	35.50	1	000964687
5	200	84	6	36.00	1	000964688
6	221	103	7	38.50	1	000964689
8	255	117	10	44.50	1	000964690
10	285	132	12	49.00	1	000964692

96THS

Clé mâle 6 pans à poignée en T haute performance H-SAFE

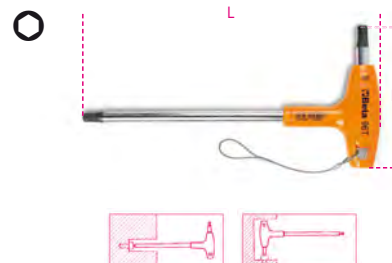

mm	L mm	L1 mm	CHF	🔧	📄
2,5	153	55	32.00	1	000964935
3	153	55	33.00	1	000964936
4	179	70	33.50	1	000964938
5	200	84	34.00	1	000964940
6	221	103	36.50	1	000964941
8	255	117	42.50	1	000964943
10	285	132	46.50	1	000964945

96THS-AS

Clé mâle 6 pans à poignée en T haute performance H-SAFE



Ø	L mm	L1 mm	Ø	CHF	🔧	📄
5/32	200	84	6	36.50	1	000964673
3/16	200	84	6	36.50	1	000964674
7/32	221	103	7	40.50	1	000964675
1/4	236	106	8	41.50	1	000964676
5/16	255	117	10	44.50	1	000964678
3/8	285	132	12	49.50	1	000964680

97TTXHS

Clé mâle pour vis TORX® à poignée en T haute performance H-SAFE

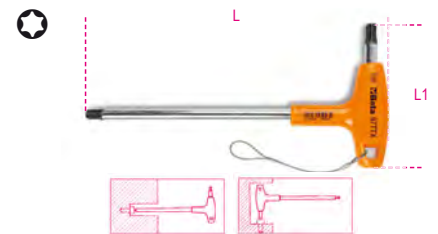

Ø	L mm	L1 mm	CHF	🔧	📄
T10	179	70	33.00	1	000974710
T15	179	70	33.50	1	000974715
T20	179	70	34.00	1	000974720
T25	179	70	34.50	1	000974725
T30	200	84	39.50	1	000974730
T40	221	103	42.00	1	000974740
T45	236	106	45.00	1	000974745
T50	255	117	56.00	1	000974750

111E-HS

Clé à molette à ouverture graduée, chromée

équipée du système de retenue antichute H-SAFE

- Rotation de la molette vers la droite
- Échelle millimétrique et en pouces



DIN 3117 ISO 6787

L mm	L "	A max mm	CHF	🔧	📄
200	8	29	65.00	1	001114120
250	10	34	73.50	1	001114125
300	12	40	91.00	1	001114130
380	15	45	155.50	1	001114138
450	18	54	246.00	1	001114145

142HS

Clé mixte à cliquet réversible H-SAFE



mm	L mm	CHF		
8x8	136	41.00	1	001424008
9x9	143	42.00	1	001424009
10x10	159	42.50	1	001424010
11x11	168	43.50	1	001424011
12x12	174	44.00	1	001424012
13x13	180	45.00	1	001424013
14x14	190	46.50	1	001424014
15x15	200	48.50	1	001424015
16x16	216	52.00	1	001424016
17x17	233	53.50	1	001424017
18x18	239	56.50	1	001424018
19x19	248	57.00	1	001424019
21x21	285	68.00	1	001424021
22x22	285	69.50	1	001424022
24x24	325	80.50	1	001424024
27x27	355	107.00	1	001424027
30x30	420	123.50	1	001424030
* 32x32	420	128.50	1	001424032

360HS

Clé serre-tubes modèle Stillson H-SAFE



L mm	Ø max " mm	CHF		
250	1" gas	66.50	1	003604025
350	1 1/2" gas	82.50	1	003604035
450	2" gas	106.50	1	003604045
600	2 1/2" gas	152.00	1	003604060



LC system, système de retenue à double sphère. Le relâchement de la douille advient uniquement par le biais de la touche

666HS

Clé dynamométrique à déclenchement avec cliquet réversible Précision de serrage : ±3%



ISO 6789

Nm	Kgfm	lbf.ft	■	D mm	A mm	L mm	g
10÷50	1÷5	7÷37	3/8	30	33	312	660

666HS/5 CHF 348.00 1 006664005

Nm	Kgfm	lbf.ft	■	D mm	A mm	L mm	g
20÷100	2÷10	15÷75	3/8	30	33	381	730

666HS/10 CHF 353.00 1 006664010

Nm	Kgfm	lbf.ft	■	D mm	A mm	L mm	LC system *	g
40÷200	4÷20	30÷150	1/2	40	43	470		1010

666HS/20LC CHF 398.00 1 006664021

Nm	Kgfm	lbf.ft	■	D mm	A mm	L mm	LC system *	g
60÷300	6÷30	50÷220	1/2	40	43	598		1380

666HS/30LC CHF 446.00 1 006664031

900E-HS/55

Cliquet réversible H-SAFE



DIN 3122 - UNI-ISO 3315

L mm	Ø mm	A mm	■	CHF		
125	25	18	1/4	64.00	1	009004880

910E-HS/55

Cliquet réversible H-SAFE

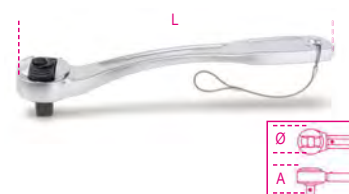

DIN 3122 - UNI-ISO 3315

L mm	Ø mm	A mm	■	CHF		
200	30	33	3/8	70.50	1	009104880

920E-HS/55LC

Cliquet réversible avec "Locking system" H-SAFE

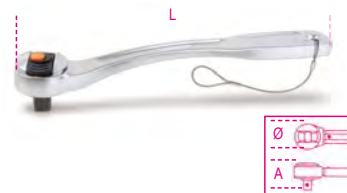

DIN 3122 - UNI-ISO 3315

L mm	Ø mm	A mm	■	CHF		
275	40	43	1/2	104.50	1	009204860

932HS

Clé à pipe débouchée chromée polie H-SAFE

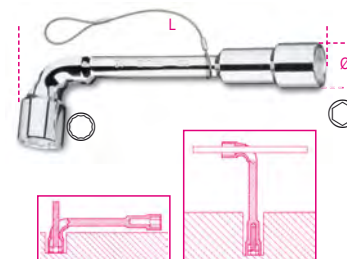

NF E 74.303

mm	Ø mm	L mm	CHF		
6x6	11,5	110	34.50	1	009324006
7x7	12,5	116	36.00	1	009324007
8x8	13,0	120	38.00	1	009324008
9x9	14,0	125	38.50	1	009324009
10x10	16,5	133	39.50	1	009324010
11x11	17,5	143	41.50	1	009324011
12x12	19,0	148	42.50	1	009324012
13x13	19,5	154	43.50	1	009324013
14x14	21,5	167	46.50	1	009324014
15x15	22,5	182	47.00	1	009324015
16x16	24,5	193	48.50	1	009324016
17x17	26,0	198	49.50	1	009324017
18x18	26,5	215	53.50	1	009324018
19x19	29,0	220	56.50	1	009324019

1032HS

Pince pour circlips intérieurs à becs droits H-SAFE



UNI 7914 DIN 5256

L mm	Ø mm	Ø1 mm	A mm	CHF		
140x1,3	12÷25	1,3	20	47.50	1	010324014
180	19÷60	1,9	21	51.00	1	010324017

Beta

1034HS

Pince pour circlips intérieurs à becs coudés à 90° H-SAFE



UNI 7914 DIN 5256

L	Ø	Ø1	A	CHF		
mm	mm	mm	mm			
170	19+60	1,9	21	54.00	1	010344017

1036HS

Pince pour circlips extérieurs à becs droits H-SAFE



UNI 7915 DIN 5254

L	Ø	Ø1	A	CHF		
mm	mm	mm	mm			
140x1,3	10+25	1,3	20	51.00	1	010364014
175	19+60	1,9	21	52.00	1	010364017

1038HS

Pince pour circlips extérieurs à becs coudés à 90° H-SAFE



UNI 7915 DIN 5254

L	Ø	Ø1	A	CHF		
mm	mm	mm	mm			
175	19+60	-	21	56.00	1	010384017

1048BM-HS

Pince multiprise entrepassée branches bimatières H-SAFE

· nouveau modèle neuf positions



ISO 8976

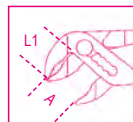

L	A max	L1	g	CHF		
mm	mm	mm	g			
250	48	39	460	80.00	1	010484215

1052HS

Pince-étau universelle à mâchoires concaves H-SAFE

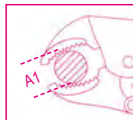

L	A	A1 max	S	CHF		
mm	mm	mm	mm			
240	72	42	10,0	65.50	1	010524024

1082BM-HS

Pince coupante diagonale branches gainées confort bi-matières H-SAFE



UNI/ISO 5749

L	L1	mm	A	CHF		
mm	mm	mm	mm			
160	22	1,6	28,0	64.50	1	010824036

1088BM-HS

Pince coupante frontale à faible effort de coupe branches gainées confort bi-matières H-SAFE

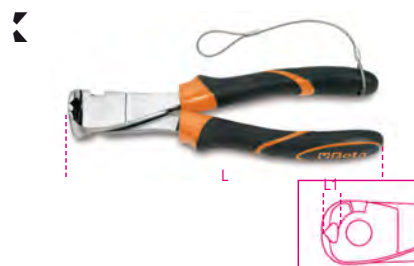

UNI/ISO 5748

L	L1	mm	A	CHF		
mm	mm	mm	mm			
160	9	1,6	28,0	74.50	1	010884036
200	11	2,0	36,0	93.00	1	010884040

1128BAX-HS

Ciseaux d'électriciens à double effet, avec profils à foret en acier inoxydable revêtu en DLC H-SAFE

Coupe à double effet : à travers une came spéciale sur le point d'appui, l'on obtient un déplacement longitudinal des lames qui, lors de la phase de fermeture, en augmente la puissance de coupe.

Profil et foret : étudiés pour élargir les orifices sur plastique de 13 à 25 mm.

Revêtement DLC : le carbone de type diamant (DLC - diamond-like carbon) est un revêtement innovant à base de carbone : la grande dureté et le faible coefficient de frottement sont dus à la présence simultanée de carbone déposé sur la surface en forme de graphite et diamant.

- Grande dureté superficielle des lames (résistance à l'abrasion et maintien de l'affûtage dans le temps)
- Faible coefficient de frottement (glissement et puissance de coupe)
- Embout excentrique anti-ralentissement
- Branches amples avec gorges auto-serrantes
- Fournis avec étui en plastique articulé



L	L1	mm²	CHF		
mm	mm	mm²			
150	50	50	62.00	1	011284088

 **Beta**

 **Beta**

1132BM-HS

Coupe-câbles branches gainées confort bi-matières H-SAFE



UNI 8791

L	A	B	CHF	Icon	Icon
mm	mm	mm			
230	18	37	113.00	1	011324143

1150BM-HS

Pince universelle chromée polie branches gainées confort bi-matières H-SAFE



ISO 5746

L	L1	A	CHF	Icon	Icon
mm	mm	mm			
160	42	1,6	56.50	1	011504146
180	46	1,8	59.00	1	011504148
200	50	2,0	64.50	1	011504150

1166BM-HS

Pince à becs demi-ronds longs striés branches gainées confort bi-matières H-SAFE



ISO 5745

L	L1	A	CHF	Icon	Icon
mm	mm	mm			
200	76	1,6	66.50	1	011664040

1168BM-HS

Pince à becs coulés demi-ronds longs striés branches gainées confort bi-matières H-SAFE



ISO 5745

L	L1	A	CHF	Icon	Icon
mm	mm	mm			
200	70	1,6	70.00	1	011684040

1290HS

Tournevis pour vis à fente H-SAFE



ISO 2380

SxAxL	L1	Ø	CHF	Icon	Icon
mm	mm	mm			
0,4x2,5x75	171	2,5	23.10	1	012904006
0,5x3x100	196	3,0	23.90	1	012904012
0,6x3,5x100	196	3,5	25.50	1	012904021
0,8x4x100	196	4,0	24.90	1	012904030
0,8x4x150	246	4,0	26.50	1	012904036
1x5,5x150	259	5,0	29.50	1	012904042
1,2x6,5x150	270	6,0	31.50	1	012904051
1,2x8x150	282	7,0	34.50	1	012904057
1,6x10x200	332	8,0	41.00	1	012904066

1292HS

Tournevis pour vis Phillips® H-SAFE



UNI/ISO 8764

PHxDxL	L1	CHF	Icon	Icon
mm	mm			
0x3x100	196	24.20	1	012924006
1x4,5x120	229	26.50	1	012924012
2x6x150	270	32.00	1	012924021
3x8x150	282	37.00	1	012924024

1294HS

Tournevis à lame fraisée pour vis à fente H-SAFE



SxDxL	L1	CHF	Icon	Icon
mm	mm			
0,5x2,5x60	156	22.50	1	012944003
0,6x3x75	171	22.70	1	012944006
0,8x4x100	196	25.00	1	012944012
1x5x125	234	29.00	1	012944018

1299HS

Tournevis pour vis Pozidriv®-Supadriv® H-SAFE



UNI/ISO 8764

PZ	L	L1	CHF	Icon	Icon
	mm	mm			
0	60	156	25.50	1	012994000
1	80	189	28.00	1	012994003
2	100	220	34.50	1	012994006
3	150	282	43.50	1	012994009

1370T-HS

Marteau de mécanicien, manche en fibre H-SAFE



g	A	L	L1	CHF	Icon	Icon
	mm	mm	mm			
300	23	300	105	47.50	1	013704630
500	27	320	118	51.50	1	013704650
1000	36	360	135	64.50	1	013704700

Beta

Beta

1370FT-HS

Marteau de mécanicien tête rivoir, manche en fibre



A	L	L1	B	CHF		
mm	mm	mm	mm			
28	280	86	22	65.50	1	013704528
30	280	92	24	66.50	1	013704530
36	300	104	29	78.50	1	013704536

1390HS

Maillet à embouts nylon, manche en bois H-SAFE



UNI 7784

D	L	L1	CHF		
mm	mm	mm			
35	310	95	60.50	1	013904035
45	320	107	86.00	1	013904045

1392HS

Maillet sans rebond à poignées surmoulées grand confort, manche en acier H-SAFE



D	L	L1	CHF		
mm	mm	mm			
35	305	115	87.50	1	013924035
40	310	125	98.00	1	013924040
50	325	135	114.00	1	013924050
60	385	155	166.00	1	013924060

1602A-HS

Pince à cosses préisolées, modèle standard H-SAFE

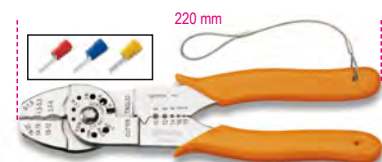

L	A	B	CHF		
mm	mm	mm			
0÷6	220	42	93.00	1	016024005

1682HS

Réglet flexible en acier inoxydable H-SAFE

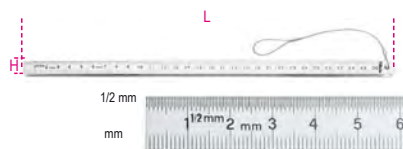

L	H	±	CHF		
mm	mm	mm			
200	13	0,5	21.00	1	016824020
300	13	0,5	23.70	1	016824030

1692HS

Mètre à ruban boîtier ABS antichoc bi-matériaux ruban en acier classe de précision: II H-SAFE



L	S	CHF		
mm	mm			
3	16	28.00	1	016924053
5	19	33.50	1	016924055

1708HS/20

Jauges d'épaisseur H-SAFE

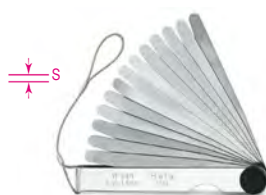

S	S1	L	CHF		
mm	mm	mm			
0,05±1,0	0,002±0,040	105	31.00	1	017084020

1727HS

Monture de scie à métaux type soudeur avec lame H-SAFE



L	L1	CHF		
mm	mm			
515	300	42.50	1	017274001

1743HS

Pince pour colliers en Nylon H-SAFE

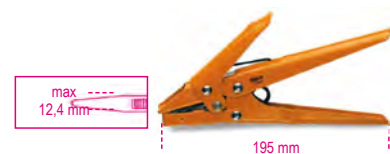

L	A	B	CHF		
mm	mm	mm			
195	85	17	88.50	1	017434001

1750HS

Pompe à graisse à levier H-SAFE



1 g, 550 bar Max

cc	L	CHF		
mm	mm			
500	380	75.00	1	017504500

1760BHS

Multimètre digital H-SAFE



SPÉCIFICATIONS

Tension CC : 200 mV-2/20/200/1000V
 Tension CA : 2-20/200/700V
 Courant CC : 2/20/200 mA-20 A
 Courant CA : 2/200 mA- 20 A
 Résistance : 200Ω - 2/20/200 kΩ - 2/20 MΩ
 Capacité : 2/20/200 nF - 2/200 μF
 Température : -20° + 1000°C/ -4 °F ~ +2000°F
 Fréquence : 20kHz
 Alimentation : 1 pile 9 V (fournie)

L	CHF		
mm			
1760BHS	296.00	1	017604012

1772H-HS

Cutter de sécurité à lame rétractable, avec 2 lames H-SAFE



L mm	A mm	CHF		
170	18	38.50	1	017724029

1778S0S-HS

Couteau de survie auto avec fonction marteau brise-vitre et coupe-ceinture de sécurité avec étui H-SAFE



L mm	A mm	L1 mm	CHF		
205	25	85	62.00	1	017784080

8871

Ceinture de sécurité avec boucle métallique à double verrouillage, pour connecter les outils H-SAFE



L cm min-max	CHF		
70-100	175.00	1	088710070
100-135	189.00	1	088710100

8872A

Passant fixe

• Pour ceinture 8871



8872A 50	CHF		
	30.50	1	088720050

8872AS

Passant ouvrable type "scratch"

• Pour ceinture 8871



8872AS 25	D mm	CHF		
	25	28.00	1	088720525

8873

Sacoche porte-outils, avec fermeture autoserrante et fermeture éclair

• Pour ceinture 8871



8873	CHF		
	148.00	1	088730230

8877

Sangle de connexion élastique

• MAX 2.7 kg



8877 80	L cm min+max	DxL mm	CHF		
	70-110	40x80	38.00	1	088770080

8877M

Sangle de connexion élastique

• Avec raccord anti-vrillage • MAX 2.7 kg



8877M 20-140	L cm min+max	DxL mm	CHF		
	20-140	30x60	67.50	1	088770510

8879

Bracelet type "scratch"

• MAX 2.7 kg



8879	D mm	CHF		
	30	43.50	1	088790025

8880

Sangle de connexion rigide

• Avec raccord anti-vrillage



8880	L Cm	D mm	CHF		
	30	10	34.00	1	088800030

8883

Sac porte-outils

- En nylon 840 anti-abrasion
- MAX 20 kg
- Mousqueton pour bloquer la fermeture éclair en fin de course
- 6 courroies antichute pour outils
- Poche interne



8883	DxH cm	CHF		
	30x40	358.00	1	088830030





OUTILS EN ACIER INOXYDABLE



Les outils BETA INOX peuvent être utilisés dans des environnements critiques, à savoir des zones où aucun niveau de contamination n'est admis.

Quelques exemples :

- Applications nucléaires
- Production pharmaceutique – classe C
- Applications en haute mer
- Laboratoires biotechnologiques et biomédicaux
- Industrie alimentaire.

Les outils Beta Inox évitent le phénomène de la rouille impropre.

En utilisant des outils qui ne sont pas en acier inoxydable sur des vis, écrous ou surfaces en acier inoxydable, des particules peuvent se détacher de ces outils et déclencher des processus de corrosion, en créant souvent des problèmes esthétiques et parfois même des problèmes structurels.

Quelques exemples d'applications :

- Chantiers navals
- Bâtiment
- Installations solaires
- Construction automobile.



**INOX + SANS INOX
= ROUILLE**



**INOX + INOX
= ABSENCE DE ROUILLE**

CARACTÉRISTIQUES

Le choix sélectif des matériaux et la recherche approfondie des meilleurs traitements thermiques confèrent aux outils Beta Inox des caractéristiques mécaniques bien au-dessus des valeurs des normes et comparables à celles des outils Beta standard.

L'ergonomie et le design des produits sont les mêmes que ceux des outils Beta connus et appréciés par les utilisateurs professionnels depuis plus de 75 ans.

L'acier inoxydable est 100% recyclable.

Une caractéristique qui a également toute son importance.



Marque pour les produits en acier inoxydable
Marque délivrée par Centro Inox – l'Association italienne pour l'Étude et le Développement des Aciers Inoxydables, caractérisant les produits réalisés en acier inoxydable.

34INOX

Burin plat,
en acier inoxydable



L mm	A mm	Ø mm	CHF		
160	18	18	53.50	1	000340318
200	20	20	78.50	1	000340320

39INOX

Coin plat,
en acier inoxydable



L mm	A mm	S mm	CHF		
100	50	10	37.00	1	000390310
150	50	13	67.00	1	000390315
200	40	40	196.00	1	000390320

42INOX

Clé mixte
en acier inoxydable



DIN 3113 - UNI ISO 7738

mm	L mm	CHF		
6x6	95	18.60	2	000420306
7x7	105	19.40	2	000420307
8x8	116	19.50	2	000420308
9x9	127	21.00	2	000420309
10x10	137	22.10	2	000420310
11x11	148	23.90	2	000420311
12x12	158	24.90	2	000420312
13x13	169	25.00	2	000420313
14x14	180	26.00	2	000420314
15x15	190	27.00	2	000420315
16x16	201	27.50	2	000420316
17x17	212	31.00	2	000420317
18x18	222	33.50	2	000420318
19x19	233	36.00	2	000420319
21x21	254	44.00	1	000420321
22x22	264	45.00	1	000420322
24x24	285	49.50	1	000420324
27x27	290	144.50	1	000420327
30x30	320	176.50	1	000420330
32x32	340	192.00	1	000420332
36x36	360	269.00	1	000420336
38x38	430	288.00	1	000420338
41x41	430	339.00	1	000420341
46x46	480	388.00	1	000420343
50x50	520	418.00	1	000420345
55x55	560	453.00	1	000420347
60x60	595	503.00	1	000420350



CHF		
282.00	1	000420391

42INOX/S11
6-8-10-11-12-13-
14-15-16-17-19 mm



CHF		
246.00	1	000420387

42INOX/SC9
8-10-11-12-13-14-15-17-19 mm

42INOX-AS

Clé mixte,
en acier inoxydable



mm	L mm	CHF		
1/4x1/4	95	22.30	1	000420356
5/16x5/16	116	22.60	1	000420358
3/8x3/8	137	27.00	1	000420360
7/16x7/16	148	29.00	1	000420361
1/2x1/2	169	30.00	1	000420363
9/16x9/16	180	32.00	1	000420364
5/8x5/8	201	34.00	1	000420366
11/16x11/16	212	39.50	1	000420367
3/4x3/4	233	43.50	1	000420369
13/16x13/16	254	49.50	1	000420371
7/8x7/8	264	52.00	1	000420372
15/16x15/16	285	59.00	1	000420373



CHF		
281.00	1	000420396

42INOX-AS/S9
1/4-5/16-3/8-7/16-1/2
9/16-5/8-11/16-3/4



96BPINOX

Clé mâle 6 pans coudée à tête sphérique,
en acier inoxydable



mm	L mm	L1 mm	g	CHF		
2	91	22	4	6.60	4	000961441
2,5	91	22	6	6.60	4	000961442
3	101	24	11	6.95	4	000961443
4	112	29	19	7.75	4	000961444
5	131	33	32	9.25	4	000961445
6	154	36	51	10.20	4	000961446
7	164	40	65	13.30	2	000961447
8	175	44	116	16.10	2	000961448
10	197	51	189	20.10	2	000961450



CHF		
64.50	1	000961455

96BPINOX/B6
2,5-3-4-5-6-8 mm

CHF		
104.50	1	000961456

96BPINOX/B9
2-2,5-3-4-5-
6-7-8-10 mm

CHF		
7.90	1	000961459

96BPINOX/BV

96BPINOX-AS

Clé mâle 6 pans coudée,
à tête sphérique,
en acier inoxydable

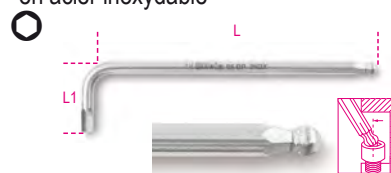

mm	L mm	L1 mm	g	CHF		
5/64	91	22	5,5	8.45	4	000961989
3/32	91	22	5,3	8.45	4	000961990
7/64	101	24	10,5	9.05	4	000961991
1/8	101	24	10,7	9.05	4	000961992
9/64	112	29	18,7	9.90	4	000961993
5/32	112	29	18,7	9.90	4	000961994
3/16	131	33	31,5	13.30	2	000961995
7/32	154	36	50,0	13.80	2	000961996
1/4	164	40	70,0	14.60	2	000961997
5/16	175	44	115,0	17.20	2	000961998
3/8	197	51	186,5	21.50	2	000961999



CHF		
102.50	1	000962000

96BPINOX-AS/B8
5/64-3/32-1/8-5/32-
3/16-7/32-1/4-5/16

CHF		
7.90	1	000961459

96BPINOX/BV

96TINOX

Clé mâle 6 pans coudée à poignée en T haute performance, en acier inoxydable

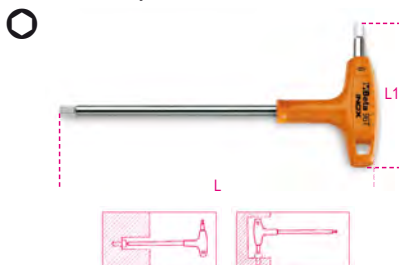

mm	L mm	L1 mm	CHF	🔧	📄
2,5	153	55	15.80	2	000961935
3	153	55	16.40	2	000961936
4	179	70	18.00	2	000961938
5	200	84	20.00	2	000961940
6	221	95	21.70	2	000961941
7	236	106	25.00	2	000961942
8	255	117	29.50	2	000961943
10	285	132	38.50	2	000961944



96TINOX/S5	CHF	🔧	📄
2,5-3-4-5-6 mm	91.50	1	000961952
96TINOX/S8	184.50	1	000961954
2,5-3-4-5-6-7-8-10 mm			

96TINOX-AS

Clé mâle 6 pans à poignée en T haute performance, en acier inoxydable

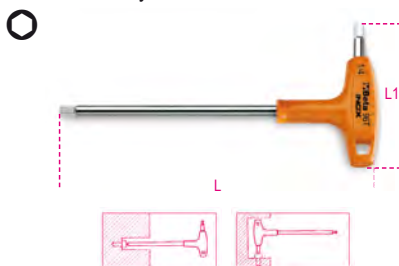

"	L mm	L1 mm	Ø mm	CHF	🔧	📄
3/32	153	55	3	17.20	2	000961861
7/64	153	55	4	17.60	2	000961862
1/8	179	70	4	19.80	2	000961863
9/64	179	70	5	20.20	2	000961864
5/32	200	84	6	21.30	2	000961865
3/16	200	84	6	22.80	2	000961866
7/32	221	103	7	26.50	2	000961867
1/4	236	106	8	28.00	2	000961868
5/16	255	117	10	34.00	2	000961869
3/8	285	132	12	37.00	2	000961870



96TINOX-AS/S7	CHF	🔧	📄
3/32-1/8-5/32-3/16-7/32-1/4-5/16	170.00	1	000961877

111INOX

Clé à molette, en acier inoxydable



DIN 3117 - ISO 6787

L mm	L "	A max mm	A1 mm	CHF	🔧	📄
150	6	18	45	114.00	1	001110315
200	8	24	58	148.00	1	001110320
250	10	30	70	184.50	1	001110325

362INOX

Clé serre-tubes modèle américain, en acier inoxydable



L mm	Ø max mm	CHF	🔧	📄
300	58	250.00	1	003620430

920INOX-A

Douille 6 pans, en acier inoxydable



DIN 3124 - UNI ISO 2725

🔧	Ø mm	A mm	L mm	CHF	🔧	📄
8	15	10	40	39.50	2	009203008
9	16	10	40	42.00	2	009203009
10	17	10	40	44.00	2	009203010
11	18	11	40	46.50	2	009203011
12	19	11	40	49.50	2	009203012
13	20	11	40	52.50	2	009203013
14	21	11	40	55.00	2	009203014
15	23	11	40	58.00	2	009203015
16	24	11	40	60.50	2	009203016
17	25	11	40	62.50	2	009203017
18	26	13	42	65.00	2	009203018
19	28	13	42	67.50	2	009203019
20	29	13	42	72.00	1	009203020
21	30	13	43	73.00	1	009203021
22	31	15	43	73.50	1	009203022
24	34	15	43	85.50	1	009203024
27	38	18	46	105.50	1	009203027
30	42	20	46	124.50	1	009203030
32	44	20	46	140.50	1	009203032

920/55INOX

Cliquet réversible carré mâle 1/2" à 72 dents, en acier inoxydable



L mm	Ø mm	A mm	CHF	🔧	📄
264	40	43	303.00	1	009203882

920/R55INOX



920/R55INOX	CHF	🔧	📄
	108.00	1	009203879

1048INOX

Pince multiprise entrepassée, en acier inoxydable

• Modèle 7 positions

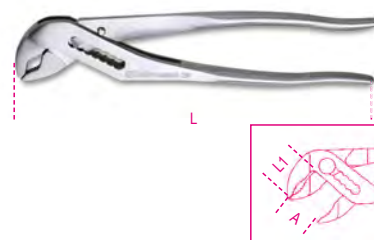

L mm	A max mm	L1 mm	CHF	🔧	📄
250	33	33	193.50	1	010480325

1082INOX

Pince coupante diagonale en acier inoxydable



L mm	L1 mm	🔧	CHF	🔧	📄
150	20,0	1,6	140.00	1	010820350

1150INOX

Pince universelle à grande force de coupe en acier inoxydable
Embout décentré joint ouvert



L mm	L1 mm	CHF	🔧	📄
180	39	137.00	1	011500518

1153INOX

Pince universelle réglable "mécanicien", en acier inoxydable



L mm	L1 mm	CHF	🔧	📄
150	26	134.00	1	011530315

1290INOX

Tournevis pour vis à fente en acier inoxydable



ISO 2380

SxAxL mm	L1 mm	Ø mm	CHF	🔧	📦
0,4x2,5x50	146	2.5	11.50	4	012900403
0,5x3x75	171	3.0	11.90	4	012900409
0,8x4x100	196	4.0	12.30	4	012900430
1,0x5,5x150	259	5.0	15.60	4	012900442
1,2x6,5x150	270	6.0	18.00	4	012900451

1292INOX

Tournevis à lame courte pour vis Phillips®, en acier inoxydable



ISO 8764

PHxDxL mm	L1 mm	CHF	🔧	📦
0x3x60	156	10.80	4	012920403
1x4,5x80	189	12.80	4	012920409
2x6x100	220	15.60	4	012920418

1293INOX/D8

Jeu de tournevis en acier inoxydable



	CHF	🔧	📦
1293INOX/D8	108.50	1	012930408
1290INOX	0,4x2,5x50-0,5x3x75		
	0,8x4x100-1,0x5,5x150-		
	1,2x6,5x150 mm		
1292INOX	PH0x60-PH1x80		
	PH2x100 mm		

1370INOX

Marteau de mécanicien en acier inoxydable



g	A mm	L mm	L1 mm	CHF	🔧	📦
500	25	240	101	121.00	1	013700375

1377INOX

Marteau américain en acier inoxydable



g	L mm	L1 mm	CHF	🔧	📦
230	220	82	70.50	1	013770623
340	220	90	101.50	1	013770634

1730INOX

Grattoir universel, en acier inoxydable



A mm	L mm	CHF	🔧	📦
50	200	62.00	1	017300450

C20TSS

Boîte à outils 5 cases en acier inoxydable AISI 304



C20TSS	CHF	🔧	📦
	377.00	1	021203001

📏: 450x200x210 mm - 🏠 4kg

Beta

C04TSS-7

Servante mobile d'atelier à 7 tiroirs complètement en acier inoxydable

Caractéristiques principales :

- 7 tiroirs de 570 x 410 mm montés sur glissières à billes de précision ;
- 6 tiroirs - hauteur 83 mm ;
- 1 tiroir - hauteur 170 mm ;
- 4 roues de Ø 125 mm: 2 fixes et 2 pivotantes avec freins ;
- Serrure centralisée centrale ;
- Structure complètement en acier inoxydable ;
- Roues, supports, sphères, intérieur des tiroirs et glissières en acier inoxydable;
- Poignée tiroirs en aluminium.

63 kg

Beta
INOX
STAINLESS STEEL

700
kg

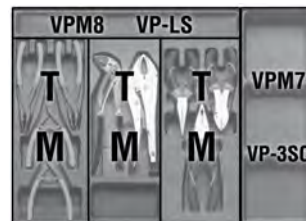

h	max
83 mm	25 kg
170 mm	30 kg

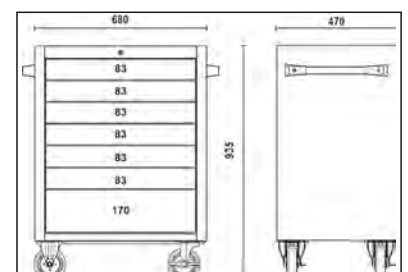
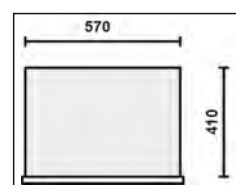

C04TSS/7

CHF 3,370.00 1 024003077



CUIVRE-BÉRYLLIUM Cu-Be

Les outils antidéflagrants **Beta** sont prévus pour opérer en toute sécurité dans les environnements à risque d'explosion potentiel, en présence de liquides ou de gaz inflammables, ou pour les applications qui nécessitent l'utilisation d'outils amagnétiques et résistants à la corrosion.



Les outils antidéflagrants sont certifiés par l'institut de recherche et d'essai BAM, conformément à la Directive européenne 99/92/EC



ATTENTION :
Risque d'explosion en présence d'**ACÉTYLÈNE**.

Les outils antidéflagrants ont des caractéristiques mécaniques différentes de celles des outils courants en acier. Nous recommandons de les utiliser avec une attention particulière, en évitant les surcharges.

CLASSIFICATION DES ZONES À RISQUE D'EXPLOSION

		ATEX	
		MOYENNE BASSE	TRÈS BASSE
GAZ	ZONE 1	Zone où pendant les activités normales il peut se former une atmosphère explosive consistant en un mélange d'air et de substances inflammables sous forme de gaz, vapeur ou brouillard.	ZONE 2 Zone où, pendant les activités normales, il est peu probable qu'il se forme une atmosphère explosive consistant en un mélange d'air et de substances inflammables sous forme de gaz, vapeur ou brouillard et, si cela se produit, le phénomène sera uniquement de courte durée.
	POUSSIÈRE	ZONE 21 Zone où pendant les activités normales il peut se former occasionnellement une atmosphère explosive sous forme de nuage de poussières combustibles dans l'air.	ZONE 22 Zone où, pendant les activités normales, il est peu probable qu'il se forme une atmosphère explosive sous forme de nuage de poussières combustibles dans l'air et, si cela se produit, le phénomène sera uniquement de courte durée.

30BA

Chasse-clous antidéflagrant



Ø mm	L mm	S mm	CHF	1	1
5	150	15	80.00	1	000300806
8	150	17	98.50	1	000300808
10	150	19	122.00	1	000300810

31BA

Chasse-goupilles antidéflagrant



Ø mm	L mm	CHF	1	1
3	110	34.50	1	000310853
4	110	75.00	1	000310854
6	115	114.00	1	000310856
8	120	129.50	1	000310858

31BA/C

Chasse-clous antidéflagrant conique



Ø mm	Ø1 mm	L mm	CHF	1	1
★6	12	150	46.50	1	000310876
★7	13	150	55.00	1	000310877
★12	18	175	117.00	1	000310882
★13	29	255	368.00	1	000310883

32BA

Pointeau antidéflagrant



Ø mm	L mm	CHF	1	1
14	150	110.50	1	000320811

34BA

Burin plat antidéflagrant



L mm	A mm	CHF	1	1
200	22	149.50	1	000340801
250	24	250.00	1	000340803
300	25	336.00	1	000340802

39BA

Coin plat antidéflagrant



L mm	A mm	CHF		
150	40	65.00	1	000390801
230	40	219.50	1	000390802
250	40	343.00	1	000390803

42BA

Clé mixte antidéflagrante



mm	L mm	CHF		
6x6	105	69.50	1	000420806
7x7	105	78.50	1	000420807
8x8	120	87.50	1	000420808
9x9	120	100.50	1	000420809
10x10	135	108.50	1	000420810
11x11	135	114.00	1	000420811
12x12	150	125.00	1	000420812
13x13	150	129.50	1	000420813
14x14	175	135.50	1	000420814
15x15	175	142.50	1	000420815
16x16	195	148.00	1	000420816
17x17	200	155.50	1	000420817
18x18	215	174.00	1	000420818
19x19	220	178.00	1	000420819
20x20	230	185.50	1	000420820
21x21	240	196.50	1	000420821
22x22	250	209.50	1	000420822
24x24	268	243.00	1	000420824
26x26	290	293.00	1	000420826
27x27	290	326.00	1	000420827
28x28	290	383.00	1	000420828
30x30	313	392.00	1	000420830
32x32	333	430.00	1	000420832
34x34	360	470.00	1	000420834
35x35	360	532.00	1	000420835
36x36	355	556.00	1	000420836
38x38	430	585.00	1	000420838
41x41	430	688.00	1	000420841
46x46	480	806.00	1	000420846
50x50	520	853.00	1	000420850
55x55	560	939.00	1	000420855
60x60	580	1,002.00	1	000420860
*65x65	595	1,142.00	1	000420865
*70x70	630	1,280.00	1	000420870

42BA-AS

Clé mixte antidéflagrante



mm	L mm	CHF		
9/32x9/32	120	75.00	1	000420946
5/16x5/16	120	75.00	1	000420947
11/32x11/32	135	95.50	1	000420948
3/8x3/8	128	100.50	1	000420950
7/16x7/16	135	114.00	1	000420951
15/32x15/32	140	126.00	1	000420949
1/2x1/2	140	131.00	1	000420953
9/16x9/16	163	141.50	1	000420954

mm	L mm	CHF		
*19/32x19/32	195	170.00	1	000420955
5/8x5/8	177	171.00	1	000420956
11/16x11/16	195	183.00	1	000420957
3/4x3/4	215	188.00	1	000420959
13/16x13/16	230	219.50	1	000420961
7/8x7/8	235	227.50	1	000420962
15/16x15/16	256	252.00	1	000420964
*31/32x31/32	265	278.00	1	000420963
1x1	266	274.00	1	000420965
1.1/16x1.1/16	283	309.00	1	000420967
1.1/8x1.1/8	297	407.00	1	000420969
1.3/16x1.3/16	308	439.00	1	000420970
1.1/4x1.1/4	324	517.00	1	000420973
*1.7/16x1.7/16	360	626.00	1	000420976

55BA

Clé à fourches antidéflagrante



mm	L mm	CHF		
6x7	90	47.50	1	000550801
8x9	100	51.50	1	000550802
8x10	100	53.50	1	000550795
9x11	110	57.00	1	000550797
10x11	120	60.50	1	000550803
12x13	130	76.00	1	000550804
*12x14	130	92.50	1	000550846
13x14	133	91.50	1	000550799
14x15	145	92.50	1	000550805
14x17	150	98.50	1	000550806
16x17	165	100.00	1	000550807
17x19	170	131.00	1	000550847
18x19	170	134.00	1	000550809
*19x22	185	152.50	1	000550810
20x22	185	153.50	1	000550811
21x23	210	167.50	1	000550813
22x24	210	199.50	1	000550815
24x26	230	234.50	1	000550817
24x27	230	250.00	1	000550818
25x28	230	271.00	1	000550819
27x29	246	317.00	1	000550820
30x32	265	371.00	1	000550822
36x38	320	470.00	1	000550826
36x41	335	517.00	1	000550828
41x46	355	642.00	1	000550829
*46x50	370	735.00	1	000550830
*50x55	385	782.00	1	000550831
*55x60	415	971.00	1	000550832

55BA-AS

Clé à fourches antidéflagrante



mm	L mm	CHF		
3/8x7/16	110	62.50	1	000550853
1/2x9/16	130	75.00	1	000550854
5/8x11/16	160	110.50	1	000550857
3/4x13/16	180	135.50	1	000550859
7/8x15/16	210	191.00	1	000550865
1x1.1/16	230	259.00	1	000550868
1.1/8x1.3/16	245	336.00	1	000550870
1.1/4x1.5/16	255	398.00	1	000550872

58BA

Clé à fourches à frapper antidéflagrante



mm	L mm	CHF		
17	125	128.50	1	000580817
19	125	133.50	1	000580819
22	135	134.00	1	000580822
24	150	150.50	1	000580824
27	165	184.50	1	000580827
30	180	232.00	1	000580830
32	190	271.00	1	000580832
*34	200	310.00	1	000580834
36	210	321.00	1	000580836
38	220	353.00	1	000580838
41	230	398.00	1	000580841
46	240	476.00	1	000580846
50	255	541.00	1	000580850
*55	305	673.00	1	000580855
*60	315	782.00	1	000580860
*65	335	909.00	1	000580865
*70	370	1,096.00	1	000580870
*75	375	1,270.00	1	000580875
*80	400	1,520.00	1	000580880
*85	400	1,785.00	1	000580885
*90	445	2,120.00	1	000580890
*95	445	2,455.00	1	000580895
*100	485	2,850.00	1	000580900
*110	513	3,520.00	1	000580901

58BA-AS

Clé à fourches à frapper antidéflagrante



mm	L mm	A mm	S mm	CHF		
*11/16	125	40,5	11,0	141.50	1	000580904
*3/4	125	40,5	11,0	144.00	1	000580905
*7/8	135	46,2	12,0	147.50	1	000580906
*15/16	150	50,3	12,0	168.50	1	000580907
*31/32	150	50,3	12,0	189.00	1	000580954
*1	175	56,9	15,0	196.00	1	000580908
*1.1/8	190	64,0	15,5	252.00	1	000580909
*1.1/4	190	64,0	15,5	296.00	1	000580910
*1.7/16	210	75,0	18,5	343.00	1	000580912
*1.1/2	220	82,0	18,5	408.00	1	000580913
*1.5/8	230	86,8	18,5	439.00	1	000580914
*1.3/4	250	98,0	20,	556.00	1	000580970

78BA

Clé polygonale contre-coudée antidéflagrante



mm	L mm	CHF		
17	145	134.00	1	000780817
19	145	147.00	1	000780819
22	165	149.50	1	000780822
24	140	183.00	1	000780824
27	155	209.50	1	000780827
30	165	243.00	1	000780830
32	180	263.00	1	000780832
34	192	290.00	1	000780834
36	208	321.00	1	000780836
38	215	376.00	1	000780838
41	225	446.00	1	000780841
46	245	500.00	1	000780846
50	250	579.00	1	000780850
55	265	673.00	1	000780855
60	275	728.00	1	000780860
65	295	782.00	1	000780865

Ø mm	L mm	CHF	1	1
70	310	885.00	1	000780870
75	325	994.00	1	000780875
80	340	1,065.00	1	000780880
*85	355	1,355.00	1	000780885
*90	380	1,595.00	1	000780890
*95	390	1,845.00	1	000780895
*100	410	2,110.00	1	000780900
*105	420	2,330.00	1	000780903
*110	445	2,660.00	1	000780901
*120	480	3,150.00	1	000780902

78BA-AS

Clé polygonale à frapper antidéflagrante



Ø mm	L mm	CHF	1	1
11/16	145	132.50	1	000780908
3/4	145	137.00	1	000780909
7/8	155	153.50	1	000780935
15/16	165	170.00	1	000780936
*31/32	165	198.50	1	000780937
1	175	198.50	1	000780938
*1.1/16	175	235.50	1	000780939
1.1/8	180	237.50	1	000780940
1.3/16	185	247.50	1	000780941
1.1/4	177	269.00	1	000780910
*1.5/16	200	274.00	1	000780954
*1.3/8	205	286.00	1	000780911
1.7/16	208	357.00	1	000780912
*1.1/2	215	372.00	1	000780913
*1.9/16	225	463.00	1	000780947
*1.11/16	225	487.00	1	000780962
1.5/8	225	453.00	1	000780914
*1.3/4	235	500.00	1	000780963
1.13/16	243	517.00	1	000780916
1.7/8	235	585.00	1	000780915
2	254	609.00	1	000780918
2.3/16	264	712.00	1	000780920
2.3/8	275	775.00	1	000780922
*2.9/16	286	806.00	1	000780924
*2.15/16	311	977.00	1	000780926
*3.1/8	325	1,135.00	1	000780928
*3.1/2	355	1,430.00	1	000780930

89BA

Clé polygonale contre-coudée antidéflagrante



Ø mm	L mm	CHF	1	1
10	200	152.00	1	000890810
11	210	157.50	1	000890811
12	220	163.00	1	000890812
13	230	167.50	1	000890813
14	240	170.00	1	000890814
16	260	183.00	1	000890816
17	270	189.00	1	000890817
18	280	204.00	1	000890818
19	300	211.00	1	000890819
20	310	263.00	1	000890820
22	330	263.00	1	000890822
24	350	288.00	1	000890824
27	370	356.00	1	000890827
30	400	398.00	1	000890830
32	420	419.00	1	000890832

90BA

Clé polygonale contre-coudée antidéflagrante



Ø mm	L mm	CHF	1	1
6x7	122	48.50	1	000900801
8x9	128	62.50	1	000900802
10x11	155	70.50	1	000900803
12x13	175	83.00	1	000900806
12X14	180	88.50	1	000900807
14x15	200	100.00	1	000900808
14x17	220	101.50	1	000900809
16x17	230	119.50	1	000900811
16x18	235	119.50	1	000900812
17X19	250	123.50	1	000900814
18x19	265	135.50	1	000900815
19x22	280	142.50	1	000900817
20x22	295	162.00	1	000900818
21x23	298	171.00	1	000900820
22x24	315	207.00	1	000900821
24x26	333	266.00	1	000900822
24x27	340	266.00	1	000900823
30x32	395	392.00	1	000900824
34x36	410	556.00	1	000900826
*36x41	450	751.00	1	000900828
*41x46	470	923.00	1	000900829
*46x50	490	1,024.00	1	000900830

91BA

Clé polygonale contre-coudée antidéflagrante



Ø mm	Ø mm	CHF	1	1
24	38	321.00	1	000910824
27	42	383.00	1	000910827
30	48	439.00	1	000910830
32	49	490.00	1	000910832
36	54	532.00	1	000910836
41	62	596.00	1	000910841
*46	69	791.00	1	000910846
*50	75	846.00	1	000910850
*55	82	977.00	1	000910855

92BA

Manche tubulaire pour 91BA, antidéflagrante



	L mm	91BA mm	Ø mm	CHF	1	1
92BA/1	460	24÷30	25	379.00	1	000920810
92BA/2	610	32÷41	28	490.00	1	000920820
*92BA/3	760	46÷55	32	658.00	1	000920830

93BA

Clé à cliquet polygonale pour échafaudages antidéflagrante



Ø mm	L mm	CHF	1	1
21x22	345	791.00	1	000930821

95BA

Clé polygonale double droite, antidéflagrante



Ø mm	L mm	CHF	1	1
7x9	115	47.50	1	000950801
8x10	115	53.50	1	000950802
10x11	140	59.00	1	000950804
10x12	140	69.50	1	000950805
12x14	145	80.00	1	000950806
14x17	165	95.50	1	000950807
*16x18	170	124.00	1	000950809
*17x19	185	108.50	1	000950808
*18x19	185	135.50	1	000950810
*19x22	200	168.50	1	000950812
*21x23	230	186.00	1	000950815
*24x27	255	237.50	1	000950817
*30x32	295	357.00	1	000950820

96BA

Clé mâle 6 pans coudée antidéflagrante

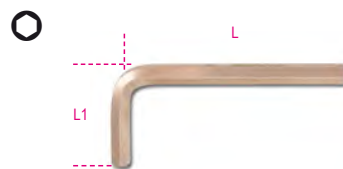

mm	L mm	L1 mm	CHF	1	1
1,5	50	17	98.50	1	000960760
2	50	16	100.50	1	000960762
2,5	56	20	108.00	1	000960761
3	63	21	109.50	1	000960763
4	69	25	115.50	1	000960764
5	78	29	119.50	1	000960765
6	88	33	122.00	1	000960766
7	93	34	128.50	1	000960767
8	97	36	135.50	1	000960768
9	104	37	142.00	1	000960769
10	110	39	147.00	1	000960770
11	118	42	156.00	1	000960771
12	122	44	178.50	1	000960772
14	150	58	199.50	1	000960774
15	156	60	211.00	1	000960775
16	162	63	232.00	1	000960776
17	168	65	243.00	1	000960777
19	177	72	272.00	1	000960779
22	186	77	319.00	1	000960802
24	192	82	368.00	1	000960804

96BA/BP

Clé mâle 6 pans coudée à tête sphérique, antidéflagrante

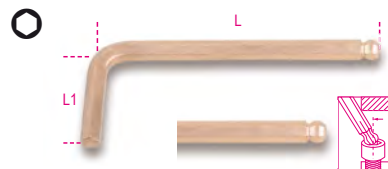

Ø mm	L mm	L1 mm	CHF	1	1
1,5	50	16	101.00	1	000961800
2	50	16	101.50	1	000961801
2,5	63	20	114.50	1	000961802
3	60	20	115.50	1	000961803
3,5	70	25	120.00	1	000961799
4	66	25	121.00	1	000961804
5	75	28	123.50	1	000961805
6	84	32	127.00	1	000961806
8	92	36	138.00	1	000961808
10	102	40	149.50	1	000961810
12	113	45	184.50	1	000961812

96BAF-AS

Clé mâle 6 pans coudée, antidéflagrante



mm	L mm	L1 mm	CHF		
*1/16	59	25	80.00	1	000962831
*5/64	59	25	82.50	1	000962832
*3/32	59	25	86.00	1	000962833
*7/64	59	25	89.00	1	000962834
*1/8	59	25	93.00	1	000962835
*9/64	64	29	100.50	1	000962836
*5/32	65	30	103.50	1	000962837
*3/16	79	31	109.50	1	000962838
*7/32	85	37	114.00	1	000962839
*1/4	85	37	119.50	1	000962840
*5/16	92	44	129.00	1	000962842
*3/8	110	45	140.00	1	000962844
*7/16	119	48	149.50	1	000962845
*1/2	140	55	183.00	1	000962846
*9/16	150	58	209.50	1	000962847

99BA

Clé à ergot pour écrous à encoches latérales antidéflagrante



mm	A mm	CHF		
32-75	4,0	260.00	1	000990803
50-120	4,5	408.00	1	000990805
115-170	4,5	658.00	1	000990811

110BA

Clé à molette à ouverture graduée antidéflagrante



L mm	A max mm	CHF		
100	13	192.00	1	001100810
150	18	220.50	1	001100815
200	24	260.00	1	001100820
250	30	314.00	1	001100825
300	36	440.00	1	001100830
375	46	593.00	1	001100837
*450	55	830.00	1	001100845
*600	65	1,385.00	1	001100860

330BA

Coupe-tubes antidéflagrante



330BA/2	Ø max 50 mm	L mm 375	CHF		
	2"		1,011.00	1	003300802

330BA/2R

Couteau et gouille de rechange pour 330BA pour tuyaux de gaz, antidéflagrant



330BA /2-R	CHF		
	101.50	1	003300822

363BA

Clé serre-tubes modèle américain antidéflagrante



L mm	Ø max mm	CHF		
150	1/2" gas	327.00	1	003630815
200	1" gas	329.00	1	003630820
250	1 1/2" gas	383.00	1	003630825
300	2" gas	487.00	1	003630830
350	2" gas	603.00	1	003630835
450	2 1/2" gas	915.00	1	003630845
600	3" gas	1,275.00	1	003630860

378BA

Clé serre-tubes modèle suédois antidéflagrante, Cuivre/Béryllium



L mm	Ø max "	CHF		
430	1" 1/2 gas	997.00	1	003780800
530	2" gas	1,230.00	1	003780801

386BA

Clé serre-tubes réversible à chaîne, gros effort, antidéflagrante

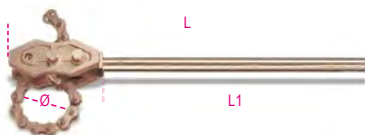

L mm	Ø max mm	L1 mm	CHF		
600	100	470	1,505.00	1	003860806
900	200	750	2,500.00	1	003860809

911BA

douille 12 pans antidéflagrante

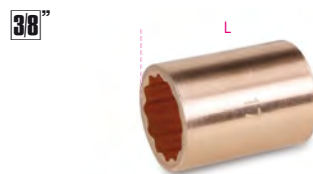

mm	L mm	CHF		
6	28	66.50	1	009110806
7	28	70.50	1	009110807
8	28	76.00	1	009110808
9	28	81.00	1	009110809
10	32	110.50	1	009110810
11	32	116.00	1	009110811
12	32	122.50	1	009110812
13	32	128.50	1	009110813
14	32	136.50	1	009110814
15	32	137.00	1	009110815
16	32	144.00	1	009110816
17	32	149.50	1	009110817
18	32	152.00	1	009110818
19	32 32	157.50	1	009110819

911BA/16

Augmentateur carré femelle 3/8" et mâle 1/2", antidéflagrant

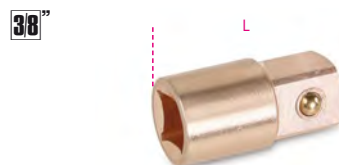

L mm	3/8"	1/2"	CHF		
34			140.00	1	009110836

911BA/20

Rallonge carrés mâle et femelle 3/8", antidéflagrant



L mm	CHF		
75	113.00	1	009110840

911BA/55

Cliquet à glissière, carré mâle 3/8", antidéflagrant

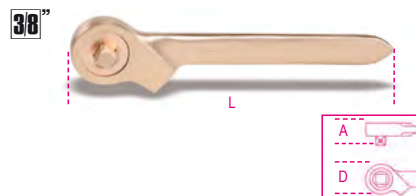

L mm	D mm	A mm	CHF		
200	45	16.5	240.50	1	009110882



921BA

Douille 12 pans antidéflagrante

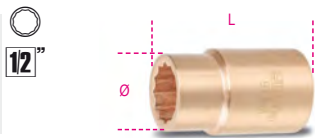

mm	Ø mm	L mm	CHF		
8	24,0	40	100.00	1	009210808
9	24,0	40	105.50	1	009210809
10	16,5	40	120.00	1	009210810
11	17,5	40	124.00	1	009210811
12	18,5	40	132.50	1	009210812
13	19,5	40	140.00	1	009210813
14	20,0	40	142.50	1	009210814
15	21,5	40	148.00	1	009210815
16	24,0	40	153.00	1	009210816
17	25,0	40	158.50	1	009210817
18	25,0	40	165.00	1	009210818
19	28,0	42	170.00	1	009210819
20	29,0	42	178.50	1	009210820
21	30,0	43	181.50	1	009210821
22	30,5	43	189.00	1	009210822
24	34,0	43	222.00	1	009210824
25	36,0	43	240.50	1	009210825
26	37,5	43	257.00	1	009210826
27	37,5	45	269.00	1	009210827
28	38,9	46	281.00	1	009210828
30	41,5	46	317.00	1	009210830
32	43,5	46	350.00	1	009210832

921BA-AS

Douille 12 pans antidéflagrante

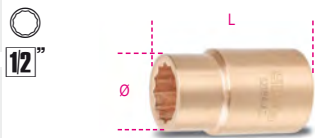

"	Ø mm	L mm	CHF		
5/16	24,0	40	106.50	1	009210958
3/8	24,0	40	114.50	1	009210960
7/16	24,0	40	125.00	1	009210961
1/2	24,0	40	134.00	1	009210963
9/16	24,0	40	140.00	1	009210964
5/8	25,0	40	158.50	1	009210966
11/16	25,5	40	171.00	1	009210967
3/4	28,0	42	189.00	1	009210969
13/16	30,0	43	199.50	1	009210971
7/8	31,5	43	218.00	1	009210972
15/16	34,0	43	230.50	1	009210974
1	36,0	43	257.00	1	009210975
1.1/16	38,0	46	277.00	1	009210977
1.1/4	42,0	46	368.00	1	009210982
1.7/16	50,5	50	453.00	1	009210986

921BA/15

Augmentateur carré femelle 1/2" et mâle 3/8", antidéflagrant



L mm	□	■	CHF		
34	1/2	3/8	126.50	1	009210839

921BA/16

adaptateur antidéflagrant, 1/2 » femelle et 3/4 » mâle



L mm	□	■	CHF		
34	1/2	3/4	166.00	1	009210840

921BA/21 - 921BA/22

Rallonge carrés mâle et femelle 1/2", antidéflagrante



	L mm	Ø mm	CHF		
921BA/21	125	30	168.50	1	009210842
921BA/22	250	31	235.50	1	009210844

921BA/25

Cardan carrés mâle et femelle 1/2", antidéflagrant



L mm	Ø mm	□	■	CHF		
80	25	1/2	1/2	171.00	1	009210845

921BA/42

Poignée coulissante carré mâle 1/2", antidéflagrante

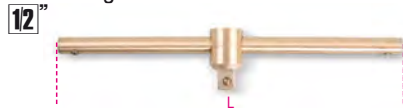

L mm	CHF		
250	278.00	1	009210846

921BA/50

Cliquet antidéflagrant



L mm	D mm	A mm	CHF		
250	45	16,5	321.00	1	009210850

921BA/R50

Set de rechange antidéflagrant



1/2"	CHF		
	95.50	1	009210851

926BA

Douille 12 pans antidéflagrante

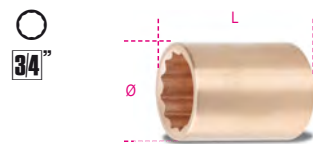

mm	Ø mm	L mm	CHF		
22	40	55	209.50	1	009260822
24	40	55	234.50	1	009260824
26	40	55	266.00	1	009260826
27	40	55	281.00	1	009260827
28	41	55	329.00	1	009260828
30	43	60	336.00	1	009260830
32	45	60	376.00	1	009260832
34	48	60	399.00	1	009260834
36	50	60	433.00	1	009260836
38	53	60	463.00	1	009260838
41	57	65	507.00	1	009260841
46	63	65	603.00	1	009260846
50	68	70	661.00	1	009260850

926BA/15

adaptateur antidéflagrant, 3/4 » femelle et 1/2 » mâle



L mm	□	■	CHF		
55	3/4	1/2	166.00	1	009260861

926BA/22

Rallonge carrés mâle et femelle 3/4", antidéflagrante



926BA/22	L mm	Ø mm	CHF		
	200	38	336.00	1	009260872

926BA/42

Poignée coulissante carré mâle 3/4", antidéflagrante



L mm	CHF		
400	487.00	1	009260876

926BA/50

Cliquet réversible à glissière carré mâle 3/4", antidéflagrant



L	D	A	CHF		
mm	mm	mm			
300	61	22	500.00	1	009260880

926BA/R50

Set de rechange antidéflagrant



3/4"	CHF		
	158.50	1	009260881

937BA

Clé à pipe débouchée 6 pans antidéflagrante



Ø	L	A	CHF		
mm	mm	mm			
13	240	45	124.00	1	009370813
17	260	51	180.00	1	009370817
19	270	55	188.00	1	009370819
22	278	59	246.00	1	009370822
24	286	63	263.00	1	009370824
27	294	69	280.00	1	009370827
30	302	75	309.00	1	009370830
32	310	81	336.00	1	009370832
*36	330	85	396.00	1	009370836
*41	350	90	477.00	1	009370841

951BA

Clé mâle 6 pans en T, antidéflagrante



mm	L	L1	CHF		
mm	mm	mm			
4	100	90	209.50	1	009510904
5	100	90	219.50	1	009510905
6	100	90	232.00	1	009510906

961BA

Dérouiller à levier antidéflagrant



L	A	CHF		
mm	mm			
250	39	184.50	1	009610802
350	55	278.00	1	009610806

963BA

Pince levier à broche et palette, antidéflagrante



L	A	CHF		
mm	mm			
500	24	516.00	1	009630801
*800	24	808.00	1	009630803
*1000	30	1,710.00	1	009630805

964BA

Clé à bonde antidéflagrante



L	CHF		
mm			
385	487.00	1	009640801

964BA/L

Cisaille universelle pour fûts, antidéflagrante

Pour l'ouverture des fûts en métal avec bord



*964BA/L	L	CHF		
	mm			
	510	2,460.00	1	009640821

965BA

Clé de serrage simple antidéflagrante pour soupapes de sûreté



A	A1	L	CHF		
mm	mm	mm			
30	44	200	213.00	1	009650830
32	50	300	298.00	1	009650832
35	47	250	243.00	1	009650835
40	50	300	280.00	1	009650840
45	58	350	361.00	1	009650845
48	62	375	376.00	1	009650848
50	67	400	413.00	1	009650850
55	73	450	494.00	1	009650855
60	79	500	532.00	1	009650860
*65	82	550	596.00	1	009650865
*70	85	600	658.00	1	009650870

966BA

Clé de serrage antidéflagrante pour soupapes de sûreté

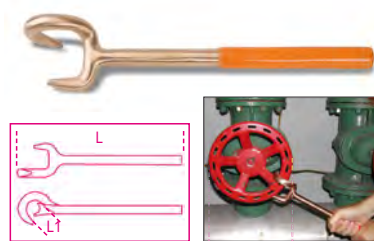

L	L1	Ø min+max	CHF		
mm	mm	mm			
350	40	50+150	467.00	1	009660801

966BA/V

Clé de serrage antidéflagrante pour soupapes de sûreté

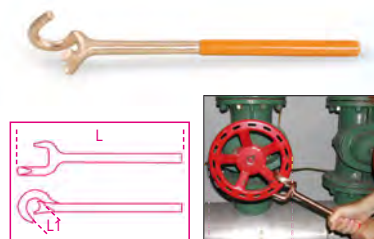

L	L1	Ø min+max	CHF		
mm	mm	mm			
370	36	125+250	467.00	1	009660812
430	48	250+400	673.00	1	009660814

1032BA

Pince pour circlips intérieurs à becs droits antidéflagrante, branches recouvertes en PVC



L	Ø	CHF		
mm	mm			
200	40+100	304.00	1	010320820

1036BA

Pince pour circlips extérieurs à becs droits antidéflagrante, branches recouvertes en PVC

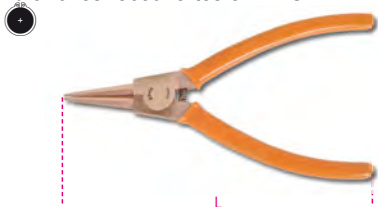

L	Ø	CHF		
mm	mm			
200	40+100	304.00	1	010360820

1046BA

Pince multiprise à crémaillère, antidéflagrante

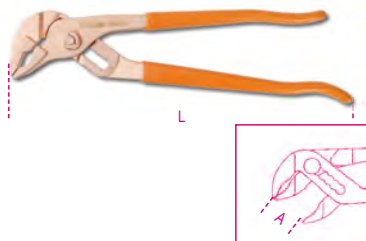

L mm	A max mm	CHF	Icon	Icon
250	32	398.00	1	010460801
*300	52	525.00	1	010460803

1052BA

Pince-étau universelle à mâchoires concaves, antidéflagrante

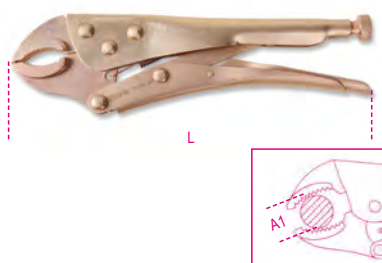

L mm	A1 max mm	CHF	Icon	Icon
225	40,0	392.00	1	010520824

1082BA

Pince coupante diagonale antidéflagrante

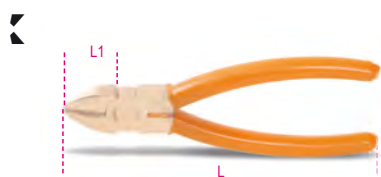

L mm	L1 mm	CHF	Icon	Icon
160	22	285.00	1	010820801

1100BA

Coupe-boulons, antidéflagrant



L mm	CHF	Icon	Icon
600	2,040.00	1	011000860

1137BA

Pince d'artificier



L mm	L1 mm	CHF	Icon	Icon
185	30	529.00	1	011370801

1137BA/RC

Lame pour 1137BA



1137BA/RC	CHF	Icon	Icon
	101.50	1	011370851

1150BA

Pince universelle chromée satinée antidéflagrante



L mm	L1 mm	CHF	Icon	Icon
200	40	335.00	1	011500820

1162BA

Pince à becs plats longs striés antidéflagrante



L mm	L1 mm	CHF	Icon	Icon
150	54	263.00	1	011620815

1166BA

Pince à becs demi-ronds longs striés branches antidéflagrante



L mm	L1 mm	CHF	Icon	Icon
150	54	263.00	1	011660815

1270BA

Tournevis pour vis à fente à lame antidéflagrante



AxL mm	L1 mm	CHF	Icon	Icon
3x75	178	47.50	1	012700803
4x100	209	59.00	1	012700804
5x150	250	78.50	1	012700805
6x150	270	83.00	1	012700806
10x250	382	126.50	1	012700810
8x200	312	94.00	1	012700808

1272BA

Tournevis pour vis Phillips® à lame antidéflagrante



PhxDxL mm	L1 mm	CHF	Icon	Icon
1x5x100	209	65.50	1	012720801
2x6x150	270	84.50	1	012720802
3x8x200	332	101.00	1	012720803

1277BA

Tournevis pour vis Torx(R), antidéflagrant



Ø	L mm	L1 mm	Ø mm	CHF	Icon	Icon
T10	75	184	5	62.50	1	012770810
T15	75	184	5	67.50	1	012770815
T20	100	209	6	91.50	1	012770820
T25	125	209	6	96.50	1	012770825
T30	150	270	6	106.50	1	012770830
T40	200	332	8	141.50	1	012770840

1370BA

Marteau de mécanicien antidéflagrant, manche en bois



g	A mm	L mm	L1 mm	CHF	Icon	Icon
500	30	310	108	176.00	1	013700805
1000	35	340	137	310.00	1	013700810

1370BA/MR

Manche pour 1370BA

	CHF		
1370BA/MR 500	29.50	1	013700865
1370BA/500			
1370BA/MR 1000	36.50	1	013700870
1370BA/1000			

1370BA/PL

Marteau de mécanicien antidéflagrant, manche en fibre



g	A mm	L mm	L1 mm	CHF		
500	30	310	108	176.00	1	013700815
1000	35	340	137	310.00	1	013700820

1375BA/PL

Marteau de charpentier antidéflagrant, manche en fibre



g	L mm	L1 mm	Ø mm	CHF		
680	321	125	30	226.50	1	013750800

1377BA

Marteau américain antidéflagrant



g	L1 mm	L mm	CHF		
340	90	280	113.00	1	013770834

1377BA/PL

Marteau américain, manche en fibre, antidéflagrant



g	L1 mm	L mm	CHF		
340	90	280	113.00	1	013770884

1379BA

Marteau à piquer antidéflagrant, manche en bois



g	L1 mm	L mm	CHF		
500	142	315	219.50	1	013790850

1380BA

Massette antidéflagrante, manche en bois



g	L1 mm	L mm	CHF		
1000	100	400	379.00	1	013800810
1500	118	400	463.00	1	013800815
2000	126	400	609.00	1	013800820

1380BA/MR

Manche pour 1380BA

	CHF		
1380BA/MR 1000	38.50	1	013800860
1380BA/1000			
1380BA/MR 1500	38.50	1	013800865
1380BA/1500			
1380BA/MR 2000	38.50	1	013800870
1380BA/2000			

1380BA/PL

Massette antidéflagrante, manche en fibre



g	L1 mm	L mm	CHF		
500	80	310	189.00	1	013800955
1000	94	350	353.00	1	013800960
1500	115	400	507.00	1	013800965
2000	125,5	400	665.00	1	013800970

1381BA

Masse antidéflagrante, manche en bois



g	L1 mm	L mm	CHF		
5000	179	900	1,415.00	1	013810850
*8000	190	900	2,270.00	1	013810858

1381BA/MR

Manche pour 1381BA

	CHF		
1381BA/MR 5000	59.00	1	013810870
1381BA/5000			
*1381BA/MR 8000	68.00	1	013810878
1381BA/8000			

1381BA/PL

Masse antidéflagrante, manche en fibre



g	L1 mm	L mm	CHF		
5000	172	900	1,300.00	1	013810885
8000	204	900	2,330.00	1	013810888

1390BA

Maillet à embouts nylon antidéflagrant



Ø mm	L mm	L1 mm	CHF		
*52	370	130	304.00	1	013900805

1390BA/R

Embout en nylon pour 1390BA



D mm	CHF		
52	62.00	4	013900885



1602BA

Pince à cosses préisolées, série légère, antidéflagrante



mm ²	L mm	CHF	Icon	Icon
0.75÷6	200	374.00	1	016020801

1701BA

Ciseau hexagonal antidéflagrante



L mm	A mm	S mm	CHF	Icon	Icon
150	12	10	69.00	1	017010810
200	16	14	110.50	1	017010814
250	18	14	135.50	1	017010815
350	19	17	357.00	1	017010817

1703BA/A

Hache antidéflagrante



L mm	L1 mm	A mm	CHF	Icon	Icon
340	145	82	310.00	1	017030082

1703BA/P

Pic antidéflagrante



A mm	L mm	L1 mm	CHF	Icon	Icon
56	1050	410	810.00	1	017030150

1703BA/PL

Pelle antidéflagrante



A mm	L1 mm	L mm	CHF	Icon	Icon
240	420	990	682.00	1	017030200

1717BA

Grattoir rigide antidéflagrante



A mm	CHF	Icon	Icon
60	166.00	1	017170801
80	184.50	1	017170803

1717BA/1

Grattoir tranchant antidéflagrante



A mm	L mm	CHF	Icon	Icon
100	220	332.00	1	017170805

1719BA8

Lime de 8" antidéflagrante



	L mm	CHF	Icon	Icon
1719BA8/P	200	204.00	1	017190801
1719BA8/M	200	211.00	1	017190805
1719BA8/R	200	215.00	1	017190810
1719BA8/T	200	198.50	1	017190815
1719BA8/Q	200	198.50	1	017190820

1719BA12

Lime de 12" antidéflagrante



	L mm	CHF	Icon	Icon
1719BA12/P	300	368.00	1	017190831

1727BA

Monture de scie à métaux avec lame antidéflagrante



L mm	L1 mm	CHF	Icon	Icon
500	300	650.00	1	017270801

1728BA

Lame de scie antidéflagrante Cuivre/Béryllium



L mm	CHF	Icon	Icon
300	126.00	1	017280801

1737BA

Brosse antidéflagrante



L mm	A mm	CHF	Icon	Icon
294	29	84.50	1	017370801

1758BA

Entonnoir antidéflagrante



Ø mm	H mm	CHF	Icon	Icon
160	150	117.00	1	017580815

1776BA

Couteau antidéflagrante



L1 mm	L mm	CHF	Icon	Icon
145	250	183.00	1	017760801

1784BA

Ciseaux antidéflagrants



L mm	CHF	Icon	Icon
225	317.00	1	017840822



1972/12

Perceuse visseuse ultra compacte 12V

- Ultra compacte, seulement 176 mm de longueur, ultra légère, seulement 1,1 kg avec batterie et parfaitement équilibrée
- Double vitesse mécanique avec engrenages en acier et embrayage à 18 positions
- Couple jusqu'à 34 Nm et 1500 tours/mn (350 tours/mn en 1ère vitesse) ; perce des diamètres jusqu'à 10 mm dans l'acier et 20 mm dans le bois
- Batteries de 2Ah et indicateur de charge sur le corps de la machine
- Triple autoprotection de la batterie (thermique, surcharge et contrôle de l'éventuelle disparité de charge entre les cellules) offre une plus grande sécurité et garantit des prestations élevées dans le temps
- Poignée ergonomique antidérapante
- LED frontale
- Mandrin autoserrant de 10 mm
- Clip pour ceinture droite/gauche
- Sélecteur vissage-dévisage-blocage (pour le transport)
- Fournie dans un coffret rigide avec 2 batteries au lithium-ion de 2 Ah et chargeur rapide (45 mn)

1,1 kg

1972/12

CHF 472.00



019720012



Beta 3-YEAR WARRANTY



1984/18QM

Clé à chocs réversible à percussion 18V brushless

Moteur digital sans brosse (brushless) : offre une considérable augmentation des prestations dont : puissance supérieure, consommations d'énergie réduite, vie utile du moteur supérieure, extrême compacité, meilleur dosage de la puissance par le biais de la touche.

- Batteries de 5Ah avec indicateur de charge
- Ultra compacte : seulement 196 mm de longueur
- Carré mâle de 1/2" avec anneau de retenue de la douille
- Clip pour ceinture droite/gauche
- Triple LED d'éclairage frontal
- Boîte d'engrenages entièrement métallique
- Sélecteur vissage-dévisage-blocage (pour le transport)
- Poignée ergonomique antidérapante
- Triple autoprotection de la batterie (thermique, surcharge et contrôle de l'éventuelle disparité de charge entre les cellules) offre une plus grande sécurité et garantit des prestations élevées dans le temps

4 modes sélectionnables :

1: 270Nm; 1400 RPM

2: 360Nm; 2000 RPM

3: 450Nm; 2750 RPM

A: 450Nm Arrêt automatique - jusqu'à ce que la clé à chocs ne détecte une rotation libre, elle applique le maximum de couple/vitesse (450Nm; 2750 RPM).

Lorsque l'écrou arrive en fin de course et ne tourne plus, la clé à chocs continue d'appliquer le maximum du couple pendant 1 seconde puis se recalibre sur le niveau le plus bas pour ne pas endommager l'écrou.

- Fournie dans un coffret rigide avec adaptateur porte-embouts hexagonal de 1/4", 2 batteries au lithium-ion de 5 Ah et chargeur rapide (80 min)

2,3 kg

1984/18QM

CHF 1,330.00



019840018



Beta 3-YEAR WARRANTY

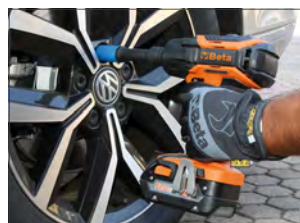

LA NOUVELLE GAMME DE MEULEUSES D'ANGLE DE MARQUE BETA

La famille d'outils électriques Beta se compose d'outils avec et sans fil. Les meuleuses filaires offrent des caractéristiques et des puissances différentes selon le type d'utilisation.

Puissance, Fiabilité et Durabilité sont les 3 points clés sur lesquels repose la nouvelle gamme, sans négliger une sécurité maximale et une facilité d'utilisation pour le professionnel.

- **Performance maximale :**
Moteur en résine puissant, résistant à l'usure et durable
Ailettes d'aération pour un refroidissement optimal,
Protections contre l'infiltration de poussière
- **Sécurité maximale pour l'opérateur :**
Dispositif de blocage de l'arbre pour un remplacement rapide du disque
Protection contre les redémarrages accidentels
Démarrage progressif
- **Confort et maniabilité maximum :**
Poignée ergonomique antidérapante pour une prise en mains plus sûre
Tête compacte afin de travailler dans des espaces restreints
Un **câble anti-emmêlement de 4 mètres de long**
Afin d'améliorer le confort de mouvement
Poignée supplémentaire pouvant être positionnée des deux côtés

1956 115-750W

meuleuse d'angle pour disques Ø 115 mm

Idéal pour les travaux de coupe, de meulage et d'ébauche Moteur puissant (750 W) Poignée ergonomique antidérapante pour un confort et une sécurité accrus Tête abaissée qui permet de travailler dans des espaces confinés Extrêmement léger (ne pèse pas plus de 1,8 kg)

Caractéristiques principales

- Protection contre l'activation accidentelle
- Poignée supplémentaire pouvant être montée des deux côtés
- Couvercle de disque sans outil (dégagement rapide)
- Dispositif de verrouillage de broche pour des changements de disque rapides
- Interrupteur à glissière verrouillez / éteignez
- Bouches d'aération protégées contre les infiltrations de poussière et offrant des performances de refroidissement optimales
- Clé de service incluse

1,8 kg

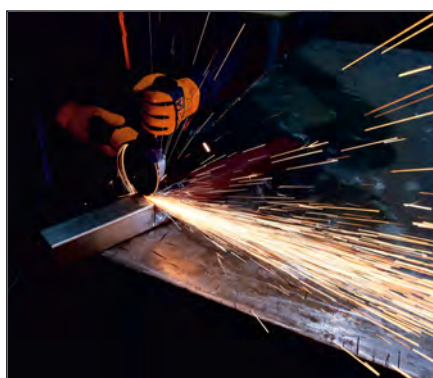

1956 115-750W

CHF 96.00 1 019560011

1956 125-1400W

meuleuse d'angle pour disques Ø 125 mm

Idéal pour les travaux de coupe, de meulage et d'ébauche Moteur puissant (1400 W) - Vitesse variable Poignée ergonomique antidérapante pour un confort et une sécurité accrus Tête abaissée qui permet de travailler dans des espaces confinés

Caractéristiques principales

- Protection contre l'activation accidentelle
- Poignée anti-vibration supplémentaire qui peut être montée des deux côtés
- Couvercle de disque sans outil (dégagement rapide)
- Dispositif de verrouillage de broche pour des changements de disque rapides
- Interrupteur à glissière verrouillez / éteignez
- Bouches d'aération protégées contre les infiltrations de poussière et offrant des performances de refroidissement optimales
- Clé de service incluse

📦 2,5 kg



1956 125-1400W

CHF 186.50 1 019560125

1956 230-2400W

meuleuse d'angle pour disques Ø 230 mm

Moteur puissant (2400 W) Poignée ergonomique antidérapante pour un confort et une sécurité accrus

Caractéristiques principales

- Protection contre l'activation accidentelle
- Fonction de démarrage progressif pour un démarrage en douceur et limiter les grandes poussées initiales de courant au démarrage
- Poignée anti-vibration supplémentaire qui peut être montée des deux côtés
- Couvercle de disque à vis
- Dispositif de verrouillage de broche pour des changements de disque rapides
- Interrupteur à glissière verrouillez / éteignez
- Bouches d'aération protégées contre les infiltrations de poussière et offrant des performances de refroidissement optimales
- Clé de service incluse

📦 5,8 kg

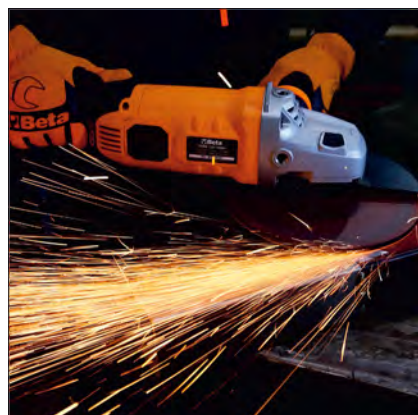

1956 230-2400W

CHF 252.00 1 019560230



OUTILLAGE PNEUMATIQUE ET ACCESSOIRES

Depuis plus de 20 ans, Beta Utensili a élargi son offre avec une gamme complète d'outillage pneumatique et d'accessoires destinés au marché automobile et à la maintenance industrielle : clés à chocs, cliquets, perceuses, meuleuses, ponceuses et bien d'autres articles.

Lors de cette période, l'étroite collaboration avec les utilisateurs professionnels a été fondamentale pour une croissance constante. C'est précisément grâce à cette croissance qu'aujourd'hui le marché reconnaît que l'outillage pneumatique Beta présente un excellent rapport fiabilité/prestations.



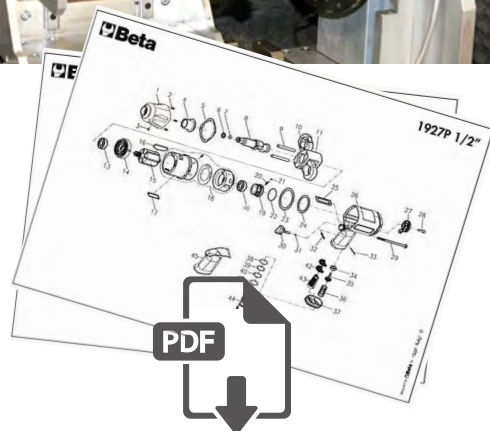
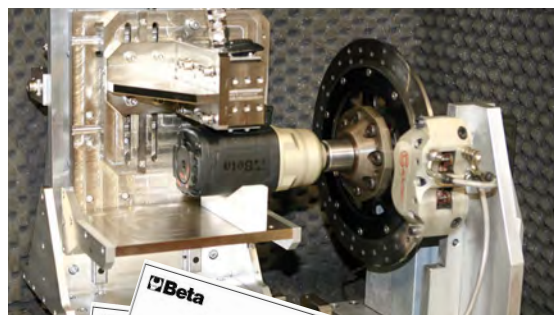























Afin de satisfaire au mieux les demandes du marché, Beta Utensili effectue les réparations des articles pneumatiques au sein de son Service Qualité. Ce processus a permis à l'entreprise de développer considérablement son propre savoir-faire et de réagir en temps réel aux demandes de la clientèle.



www.beta-tools.com



GUIDE AU CHOIX D'OUTILS PNEUMATIQUES

CLÉS À CHOCS

■	CODE BETA	N °.	MATÉRIAU	 max. Nm	 db (A) LpA	 db (A) LpW	 l/min.	 kg	MÉCANISME	 m/s ²
3/8"		1924F	Aluminium	108	93.6	104.6	59	0,5	Double frappe	6.85
3/8"		1924B	Aluminium	353	91	95	80	1,5	Pin clutch	7.9
3/8"		1924CD	Composite	410	91.7	102.7	79	1,3	Double frappe	6.2
1/2"		1927AN	Aluminium	244	89.4	100.4	190	2,1	Simple frappe	8.63
1/2"		1927G	Aluminium	325	92.2	103.2	113	1,2	Simple frappe	9.96
1/2"		1927B	Aluminium	705	98.0	109.0	133	2,1	Pin clutch	14.08
1/2"		1927XM	Aluminium	770	102	113	122	1,3	Simple frappe	7.5
1/2"		1927CD	Composite	1.020	95.5	106.5	130	2,3	Double frappe	7.2
1/2"		1927P	Composite	1.750	95.1	106.1	290	2,0	Double frappe	6.7
3/4"		1928XM	Aluminium	1.600	91.8	102.8	175	2,9	Double frappe	12.96
3/4"		1928DA	Aluminium	1.695	96	99.5	300	4,3	Double frappe	3.6
3/4"		1928DAL	Aluminium	1.695	96	99.5	300	4,8	Double frappe	3.6
3/4"		1928CD	Composite	1.800	97.5	108.5	215	3,5	Double frappe	11.4
1"		1930CD	Composite	2.445	95.6	97.1	410	7,1	Double frappe	3,6
1"		1930PA	Aluminium	2.445	96.0	97.1	410	9,6	Double frappe	7,2
1"		1930A	Aluminium	2.445	103.3	114.3	460	9,5	Double frappe	67
1"		1930LH	Aluminium	2.441	97.1	108.1	282	7,1	Double frappe	17.4
1"		1930LA	Aluminium	2.445	95.6	97.1	460	10,6	Double frappe	3,6
1"		1930HLA	Aluminium	3.661	99	101	460	16,4	Double frappe	16,4
1 1/2"		1930ZL	Aluminium	4.068	102.4	113.4	480	15	Double frappe	69.6

GUIDE AU CHOIX D'OUTILS PNEUMATIQUES

CLIQUETS

■	CODE BETA	N°.	 max. Nm	 db (A) LpA	 db (A) LpW	 l/min.	 kg	 m/s ²
1/4"		1921B1	24	96	85	90	0,4	2.6
1/4"		1921M1	27	84	88	96	0,6	1.8
1/4"		1922P1	68	90.6	101.6	88	0,6	8.61
3/8"		1921M2	27	84	88	96	0,6	1.8
3/8"		1922P2	68	90.6	101.6	88	0,6	8.61
1/2"		1921N3	68	80	87	140	1,2	2.6
1/2"		1922P3	136	94.9	105.9	113	1,5	18.28

GRINDERS

	CODE BETA	N°.	PUISSANCE	 db (A) LpA	 db (A) LpW	 l/min.	 kg	 m/s ²
		1933	0,20 kW	80.0	87.0	230	0,38	4.53
		1933L	0,20 kW	80.0	87.0	270	0,67	1.15
		1933AN90	0,20 kW	80.0	87.0	230	0,51	1.24
		1933I	0,38 kW	80.0	87.0	260	0,67	4.53
		1933IL	0,38 kW	79.0	97.0	113	1,4	1.6
		1933IH	0,75 kW	88.1	99.1	370	0,8	2.6
		1933ILH	0,75 kW	85.7	96.7	370	1,2	1.4
		1933AN90-H	0,75 kW	85.6	96.6	370	1,1	6.7
		1934MAV	0,04 kW	71	76	115	0,2	2.5
		1934MAV70	0,08 kW	80	87	115	0,2	4

1921B1

Mini-cliquet réversible

1/4"

CE



Vitesse à vide	350 tours/min
Couple de serrage maximum	24 Nm
Capacité vis/écrou	Cl 8.8 M7●11 mm
Capacité vis/écrou	Cl 12.9 M6●10 mm
Filetage d'arrivée d'air	1/4" GAS
Pression d'utilisation	6,2 bar
Ø intérieur du tuyau d'air	8 mm
Consommation d'air moyenne	68 l/min
Poids	0,4 kg

1/4	kg	CHF	1	019210001
		320.00		

1921N3

Cliquet réversible

1/2"

CE



Vitesse à vide	150 tours/min
Couple de serrage maximum	68 Nm
Capacité vis/écrou	Cl 8.8 M10●16 mm
Capacité vis/écrou	Cl 12.9 M8●13 mm
Filetage d'arrivée d'air	1/4" GAS
Pression d'utilisation	6,2 bars
Ø intérieur du tuyau d'air	10 mm
Consommation d'air moyenne	140 l/min
Poids	1,2 kg

1/2	kg	CHF	1	019210025
	1,2	282.00		

1922P3

Cliquet à impulsion réversible

1/2"

CE



Vitesse à vide	600 tours/min
Couple de serrage maximum	136 Nm
Capacité vis/écrou	Cl 8.8 M12●18 mm
Capacité vis/écrou	Cl 12.9 M10●16 mm
Filetage d'arrivée d'air	1/4" GAS
Pression d'utilisation	6,2 bar
Ø intérieur du tuyau d'air	10 mm
Consommation d'air moyenne	113 l/min
Poids	1,5 kg

1/2	kg	CHF	1	019220013
	1,5	539.00		

1921M1

Cliquet réversible compact

1/4"

CE



Vitesse à vide	200 tours/min
Couple de serrage maximum	27 Nm
Capacité vis/écrou	Cl 8.8 M7●11 mm
Capacité vis/écrou	Cl 12.9 M6●10 mm
Filetage d'arrivée d'air	1/4" GAS
Pression d'utilisation	6,2 bars
Ø intérieur du tuyau d'air	8 mm
Consommation d'air moyenne	96 l/min
Poids	0,6 kg

1/4	kg	CHF	1	019210005
	0,6	282.00		

1922P1

Cliquet à impulsion réversible

1/4"

CE



Vitesse à vide	700 tours/min
Couple de serrage maximum	68 Nm
Capacité vis/écrou	Cl 8.8 M10●16 mm
Capacité vis/écrou	Cl 12.9 M8●13 mm
Filetage d'arrivée d'air	1/4" GAS
Pression d'utilisation	6,2 bar
Ø intérieur du tuyau d'air	10 mm
Consommation d'air moyenne	88 l/min
Poids	0,6 kg

1/4	kg	CHF	1	019220006
	0,6	342.00		

1924F

Clé à chocs réversible compacte "papillon"

3/8"

CE



Vitesse à vide	12.000 tours/min
Couple de serrage maximum	108 Nm
Capacité vis/écrou	Cl 8.8 M12●18 mm
Capacité vis/écrou	Cl 12.9 M10●16 mm
Filetage d'arrivée d'air	1/4" GAS
Pression d'utilisation	6,2 bar
Ø intérieur du tuyau d'air	10 mm
Consommation d'air moyenne	59 l/min
Poids	0,5 kg

3/8	kg	CHF	1	019240025
	0,5	317.00		

1921M2

Cliquet réversible compact

3/8"

CE



Vitesse à vide	200 tours/min
Couple de serrage maximum	27 Nm
Capacité vis/écrou	Cl 8.8 M7●11 mm
Capacité vis/écrou	Cl 12.9 M6●10 mm
Filetage d'arrivée d'air	1/4" GAS
Pression d'utilisation	6,2 bars
Ø intérieur du tuyau d'air	8 mm
Consommation d'air moyenne	96 l/min
Poids	0,6 kg

3/8	kg	CHF	1	019210015
	0,6	282.00		

1922P2

Cliquet à impulsion réversible

3/8"

CE



Vitesse à vide	700 tours/min
Couple de serrage maximum	68 Nm
Capacité vis/écrou	Cl 8.8 M10●16 mm
Capacité vis/écrou	Cl 12.9 M8●13 mm
Filetage d'arrivée d'air	1/4" GAS
Pression d'utilisation	6,2 bar
Ø intérieur du tuyau d'air	10 mm
Consommation d'air moyenne	88 l/min
Poids	0,6 kg

3/8	kg	CHF	1	019220010
	0,6	342.00		



1924B

Clé à chocs réversible compacte

• Mécanisme à percussion "Pin Clutch"



Vitesse à vide	10.000 tours/min
Couple de serrage maximum	353 Nm
Capacité vis/écrou	CI 8.8 M16 ● 24 mm
Capacité vis/écrou	CI 12.9 M14 ● 21 mm
Filetage d'arrivée d'air	1/4" GAS
Pression d'utilisation	6,2 bar
Ø intérieur du tuyau d'air	8 mm
Consommation d'air moyenne	80 l/min
Poids	1,5 kg

3/8" 1,5 kg CHF 365.00 1 019240021

1924XM

Clé à chocs réversible compacte

• Mécanisme à simple frappe



Vitesse à vide	9.000 tour/min
Couple de serrage maximum	515 Nm
Capacité vis/écrou	CI 8.8 M16 ● 24 mm
Capacité vis/écrou	CI 12.9 M14 ● 21 mm
Filetage d'arrivée d'air	1/4" GAS
Pression d'utilisation	6,2 bar
Ø intérieur du tuyau d'air	10 mm
Consommation d'air moyenne	122 l/min
Poids	1,3 kg

3/8" 1,3 kg CHF 352.00 1 019240030

1927B/K5

clé à chocs réversible, en aluminium, fournie avec 5 douilles d'impact, en coffret



Vitesse à vide	7.000 rpm
Couple Max	705 Nm
Capacité vis/écrou	CI 8.8 M22 ● 34 mm
Capacité vis/écrou	CI 12.9 M18 ● 27 mm
Entrée d'air	1/4" GAS
Pression de service	6,2 bar
Taille du tuyau interne (Ø)	10 mm
Consommation moyenne d'air	133 l/min
Poids	2,1 kg

1/2" 3,5 kg CHF 324.00 1 019270122
350x305x86 mm

1924CD

Clé à chocs réversible en matériau composite

• Mécanisme à double frappe



Vitesse à vide	10.000 tours/min
Couple de serrage maximum	410 Nm
Capacité vis/écrou	CI 8.8 M16 ● 24 mm
Capacité vis/écrou	CI 12.9 M14 ● 21 mm
Filetage d'arrivée d'air	1/4" GAS
Pression d'utilisation	6,2 bar
Ø intérieur du tuyau d'air	8 mm
Consommation d'air moyenne	79 l/min
Poids	1,3 kg

3/8" 1,3 kg CHF 441.00 1 019240007

1927B

Clé à chocs réversible

• Mécanisme à "Pin Clutch"



Vitesse à vide	7.000 tours/min
Torque max.	705 Nm
Capacité vis/écrou	CI 8.8 M22 ● 34 mm
Capacité vis/écrou	CI 12.9 M18 ● 27 mm
Filetage d'arrivée d'air	1/4" GAS
Pression d'utilisation	6,2 bar
Ø intérieur du tuyau d'air	10 mm
Consommation d'air moyenne	133 l/min
Poids	2,1 kg

1/2" 2,1 kg CHF 245.50 1 019270022

1927CD

Clé à chocs réversible en matériau composite

• Mécanisme à double frappe



Vitesse à vide	7.000 tours/min
Couple de serrage maximum	1.020 Nm
Capacité vis/écrou	CI 8.8 M22 ● 34 mm
Capacité vis/écrou	CI 12.9 M18 ● 27 mm
Filetage d'arrivée d'air	1/4" GAS
Pression d'utilisation	6,2 bar
Ø intérieur du tuyau d'air	10 mm
Consommation d'air moyenne	130 l/min
Poids	2,3 kg

1/2" 2,3 kg CHF 508.00 1 019270007

1927CD/K3

Composition d'une clé à chocs réversible et de 3 douilles à chocs

• Mécanisme à double frappe

12"
CE



720LC17-19-21 mm

Vitesse à vide	7.000 tours/min
Couple de serrage maximum	1.020 Nm
Capacité vis/écrou	Cl 8.8 M22●34 mm
Capacité vis/écrou	Cl 12.9 M18●27 mm
Filetage d'arrivée d'air	1/4" GAS
Pression d'utilisation	6,2 bars
Ø intérieur du tuyau d'air	10 mm
Consommation d'air moyenne	130 l/min
Poids	1,9 kg

1/2 kg 4 CHF 572.00 1 019270107
350x305x86 mm

1927P/K3

Clé à chocs réversible en matériau composite fournie avec 3 douilles à chocs

12"
CE



720LC17-19-21 mm

Vitesse à vide	7.500 tours/min
Couple de serrage maximum	1.750 Nm
Capacité vis/écrou	Cl 8.8 M24●36 mm
Capacité vis/écrou	Cl 12.9 M20●30 mm
Filetage d'arrivée d'air	1/4" GAS
Pression d'utilisation	6,2 bars
Ø intérieur du tuyau d'air	10 mm
Consommation d'air moyenne	290 l/min
Poids	2,9 kg

1/2 kg 4 CHF 646.00 1 019270118
350x305x86 mm

1927XM

Clé à chocs réversible compacte

• Mécanisme à simple frappe

12"
CE



Ø 1/4" GAS BSPT

Vitesse à vide	10.000 tours/min
Couple de serrage maximum	770 Nm
Capacité vis/écrou	Cl 8.8 M22●34 mm
Capacité vis/écrou	Cl 12.9 M18●27 mm
Filetage d'arrivée d'air	1/4" GAS
Pression d'utilisation	6,2 bar
Ø intérieur du tuyau d'air	10 mm
Consommation d'air moyenne	122 l/min
Poids	1,3 kg

1/2 kg 1,3 CHF 374.00 1 019270030

1927P

Clé à chocs réversible en matériau composite

• Mécanisme à double frappe

12"
CE



Ø 1/4" GAS BSP

Vitesse à vide	7.500 tours/min
Couple de serrage maximum	1.750 Nm
Capacité vis/écrou	Cl 8.8 M24●36 mm
Capacité vis/écrou	Cl 12.9 M20●30 mm
Filetage d'arrivée d'air	1/4" GAS
Pression d'utilisation	6,2 bar
Ø intérieur du tuyau d'air	10 mm
Consommation d'air moyenne	290 l/min
Poids	2 kg

1/2 kg 2,0 CHF 554.00 1 019270008

1927PAL

Clé à chocs réversible en matériau composite

• Mécanisme à double frappe
• Arbre d'une longueur de 2"

12"
CE



Ø 1/4" GAS BSP

Vitesse à vide	7.500 tours/min
Couple de serrage maximum	1.750 Nm
Capacité vis/écrou	Cl 8.8 M24●36 mm
Capacité vis/écrou	Cl 12.9 M20●30 mm
Filetage d'arrivée d'air	1/4" GAS
Pression d'utilisation	6,2 bar
Ø intérieur du tuyau d'air	10 mm
Consommation d'air moyenne	290 l/min
Poids	2,2 kg

1/2 kg 2,2 CHF 697.00 1 019270009

1927XM/K5

Composition d'une clé à chocs réversible compacte 1927XM et de 5 douilles à chocs

• Mécanisme de simple frappe

12"
CE



720 17-19-21-22-24 mm

Vitesse à vide	10.000 tours/min
Couple de serrage maximum	770 Nm
Capacité vis/écrou	Cl 8.8 M22●34 mm
Capacité vis/écrou	Cl 12.9 M18●27 mm
Filetage d'arrivée d'air	1/4" GAS
Pression d'utilisation	6,2 bars
Ø intérieur du tuyau d'air	10 mm
Consommation d'air moyenne	122 l/min
Poids	1,3 kg

1/2 kg 2,8 CHF 455.00 1 019270129
307x206x86 mm

1927AN

Clé à chocs réversible à renvoi d'angle

- Mécanisme de simple frappe

12"

CE



Vitesse à vide	4.700 tours/min
Couple de serrage maximum	244 Nm
Capacité vis/écrou	CI 8.8 M14 ● 21 mm
Capacité vis/écrou	CI 12.9 M12 ● 19 mm
Filetage d'arrivée d'air	1/4" GAS
Pression d'utilisation	6,2 bar
Ø intérieur du tuyau d'air	10 mm
Consommation d'air moyenne	190 l/min

1/2"	kg	CHF	1	019270012
	2,1	661.00		

1927G

Clé à chocs réversible compacte

- Mécanisme à simple frappe

12"

CE



Vitesse à vide	8500 tours/min
Torque max.	325 Nm
Capacité vis/écrou	CI 8.8 M16 ● 24 mm
Capacité vis/écrou	CI 12.9 M14 ● 21 mm
Filetage d'arrivée d'air	1/4" GAS
Pression d'utilisation	6,2 bar
Ø intérieur du tuyau d'air	10 mm
Consommation d'air moyenne	113 l/min
Poids	1,2 kg

1/2"	kg	CHF	1	019270050
	1,2	543.00		

1927SP-AM

Support magnétique pour clé à chocs pneumatique

- Équipé de deux aimants à haute tenue avec caoutchouc de protection
- Permet de loger 1 clé à chocs 1/2", 4 douilles et 1 clé dynamométrique
- Capacité : 10 kg



400 g	CHF	1	019270000
	80.50		

1928XM

Clé à chocs réversible compacte

- Mécanisme double frappe
- Extrêmement compacte et puissante
- Commande d'inversion à touche actionnable d'une seule main
- Trois niveaux de réglage de la puissance de vissage
- Échappement de l'air par la poignée

3/4"

CE



Vitesse à vide	4.800 tours/min
Couple de serrage maximum	1.600 Nm
Capacité vis/écrou	CI 8.8 M27 ● 41 mm
Capacité vis/écrou	CI 12.9 M24 ● 36 mm
Filetage d'arrivée d'air	3/8" GAS
Pression d'utilisation	6,2 bars
Ø intérieur du tuyau d'air	10 mm
Consommation d'air moyenne	175 l/min
Poids	2,9 kg

3/4"	kg	CHF	1	019280030
	2,9	742.00		

1928CD

Clé à chocs réversible en matériau composite

- Mécanisme à double frappe

3/4"

CE



Vitesse à vide	4.500 tours/min
Couple de serrage maximum	1.800 Nm
Capacité vis/écrou	CI 8.8 M27 ● 41 mm
Capacité vis/écrou	CI 12.9 M24 ● 36 mm
Filetage d'arrivée d'air	3/8" GAS
Pression d'utilisation	6,2 bar
Ø intérieur du tuyau d'air	10 mm
Consommation d'air moyenne	215 l/min
Poids	3,5 kg

3/4"	kg	CHF	1	019280007
	3,5	1.220.00		

1928DA

Clé à chocs réversible

- Mécanisme à double frappe

3/4"

CE



Vitesse à vide	5.000 tours/min
Couple de serrage maximum	1.695 Nm
Capacité vis/écrou	CI 8.8 M30 ● 46 mm
Capacité vis/écrou	CI 12.9 M27 ● 41 mm
Filetage d'arrivée d'air	3/8" GAS
Pression d'utilisation	6,2 bar
Ø intérieur du tuyau d'air	10 mm
Consommation d'air moyenne	240 l/min
Poids	4,3 kg

3/4"	kg	CHF	1	019280022
	4,3	1.073.00		

1928DAL

Clé à chocs réversible

- Mécanisme à double frappe

3/4"

CE



Vitesse à vide	5.000 tours/min
Couple de serrage maximum	1.695 Nm
Capacité vis/écrou	CI 8.8 M27 ● 41 mm
Capacité vis/écrou	CI 12.9 M24 ● 36 mm
Filetage d'arrivée d'air	3/8" GAS
Pression d'utilisation	6,2 bar
Ø intérieur du tuyau d'air	10 mm
Consommation d'air moyenne	240 l/min
Poids	4,8 kg

3/4"	kg	CHF	1	019280023
	4,8	1.151.00		

1928K4

Coffret clé à chocs réversible
et quatre douilles à chocs longues

• Mécanisme à percussion "Pin Clutch"

3/4"
CE



728L 27-30-32-36 mm

Vitesse à vide	4.000 tours/min
Couple de serrage maximum	1.493 Nm
Capacité vis/écrou	Cl 8.8 M27●41 mm
Capacité vis/écrou	Cl 12.9 M24●36 mm
Filetage d'arrivée d'air	3/8" GAS BSP
Pression d'utilisation	6,2 bar
Ø intérieur du tuyau d'air	10 mm
Consommation d'air moyenne	260 l/min
Poids clé à chocs	5,2 kg

3/4"	kg	CHF	1	019280104
9,3	1,095.00			
410x330x106 mm				

1930CD

Clé à chocs réversible en matériau composite

• Mécanisme à double frappe

1"
CE



Vitesse à vide	4.000 tours/min
Couple de serrage maximum	2.445 Nm
Capacité vis/écrou	Cl 8.8 M36●55 mm
Capacité vis/écrou	Cl 12.9 M30●46 mm
Filetage d'arrivée d'air	1/2" GAS
Pression d'utilisation	6,2 bar
Ø intérieur du tuyau d'air	13 mm
Consommation d'air moyenne	320 l/min
Poids	7,1 kg

1"	kg	CHF	1	019300022
7,1	1,780.00			

1930LH

Clé à chocs réversible

• Mécanisme à double frappe

1"
CE



Vitesse à vide	6.000 tours/min
Torque max.	2.441 Nm
Capacité vis/écrou	Cl 8.8 M36●55 mm
Capacité vis/écrou	Cl 12.9 M30●46 mm
Filetage d'arrivée d'air	1/2" GAS
Pression d'utilisation	6,2 bar
Ø intérieur du tuyau d'air	13 mm
Consommation d'air moyenne	280 l/min
Poids	7,1 kg

1"	kg	CHF	1	019300030
7,1	1,655.00			

1930PA

Clé à chocs réversible

• Mécanisme à double frappe

1"
CE



Vitesse à vide	3.500 tours/min
Couple de serrage maximum	2.445 Nm
Capacité vis/écrou	Cl 8.8 M36●55 mm
Capacité vis/écrou	Cl 12.9 M30●46 mm
Filetage d'arrivée d'air	1/2" GAS
Pression d'utilisation	6,2 bar
Ø intérieur du tuyau d'air	13 mm
Consommation d'air moyenne	350 l/min
Poids	9,6 kg

1"	kg	CHF	1	019300032
9,6	1,600.00			

1930LA

clé a chocs réversible

• Système de frappe double marteaux

1"
CE



Vitesse à vide	4.000 rpm
Couple de serrage maximum	2.445 Nm
Capacité vis/écrou	Cl 8.8 M36●55 mm
Capacité vis/écrou	Cl 12.9 M30●46 mm
Filetage d'arrivée d'air	1/2" GAS
Pression d'utilisation	6,2 bar
Ø intérieur du tuyau d'air	13 mm
Consommation d'air moyenne	460 l/min
Poids	10,6 kg

1"	kg	CHF	1	019300037
10,6	1,685.00			

1930A

Clé à chocs réversible

• Mécanisme à double frappe

1"
CE



Vitesse à vide	4.000 tours/min
Couple de serrage maximum	2.445 Nm
Capacité vis/écrou	Cl 8.8 M36●55 mm
Capacité vis/écrou	Cl 12.9 M30●46 mm
Filetage d'arrivée d'air	1/2" GAS
Pression d'utilisation	6,2 bar
Ø intérieur du tuyau d'air	13 mm
Consommation d'air moyenne	460 l/min
Poids	9,5 kg

1"	kg	CHF	1	019300036
9,5	1,625.00			

1930HLA

Clé à chocs réversible 1"

• Mécanisme à double frappe

1"

CE



Vitesse à vide	3.000 tours/min
Couple de serrage maximum	3.661 Nm
Capacité vis/écrou	Cl 8.8 M42 ● 65 mm
Capacité vis/écrou	Cl 12.9 M33 ● 50 mm
Filetage d'arrivée d'air	1/2" GAS
Pression d'utilisation	6,2 bar
Ø intérieur du tuyau d'air	13 mm
Consommation d'air moyenne	460 l/min
Poids	16,4 kg

1	kg	16,4	CHF	2,330.00	1	019300040
---	----	------	-----	----------	---	-----------

1930ZL

Clé à chocs réversible

• Mécanisme à double frappe

1 1/2"

CE



Vitesse à vide	3.000 tours/min
Couple de serrage maximum	4.068 Nm
Capacité vis/écrou	Cl 8.8 M42 ● 65 mm
Capacité vis/écrou	Cl 12.9 M36 ● 55 mm
Filetage d'arrivée d'air	1/2" GAS
Pression d'utilisation	6,2 bar
Ø intérieur du tuyau d'air	13 mm
Consommation d'air moyenne	480 l/min
Poids	15 kg

1 1/2	kg	15	CHF	2,930.00	1	019300070
-------	----	----	-----	----------	---	-----------

1931CD6

Perceuse réversible en matériau composite

Ø 6

CE



Vitesse à vide	2.600 tours/min
Capacité mandrin	1+6 mm
Puissance	0,23 kW
Filetage de la broche	3/8" - 24UNF
Filetage d'arrivée d'air	1/4" GAS
Pression d'utilisation	6,2 bar
Ø intérieur du tuyau d'air	8 mm
Consommation d'air moyenne	130 l/min
Poids	0,6 kg

1	kg	0,6	CHF	337.00	1	019310006
---	----	-----	-----	--------	---	-----------

1931CD10

Perceuse réversible en matériau composite

Ø 10

CE



Vitesse à vide	1.800 tours/min
Capacité mandrin	1+10 mm
Puissance	0,38 kW
Filetage de la broche	3/8" - 24UNF
Filetage d'arrivée d'air	1/4" GAS
Pression d'utilisation	6,2 bar
Ø intérieur du tuyau d'air	10 mm
Consommation d'air moyenne	170 l/min
Poids	1 kg

1	kg	1,0	CHF	304.00	1	019310010
---	----	-----	-----	--------	---	-----------

1931CD13

Perceuse réversible en matériau composite

Ø 13

CE



Vitesse à vide	800 tours/min
Capacité mandrin	1,0+13 mm
Puissance	0,38 kW
Filetage de la broche	1/2" - 20UNC
Filetage d'arrivée d'air	1/4" GAS
Pression d'utilisation	6,2 bar
Ø intérieur du tuyau d'air	10 mm
Consommation d'air moyenne	170 l/min
Poids	1,3 kg

1	kg	1,3	CHF	451.00	1	019310013
---	----	-----	-----	--------	---	-----------

1931AN10

Perceuse à renvoi d'angle réversible

Ø 10

CE



Vitesse à vide	1.400 tours/min
Capacité mandrin	1+10 mm
Puissance	0,38 kW
Filetage de la broche	3/8" - 24UNF
Filetage d'arrivée d'air	1/4" GAS
Pression d'utilisation	6,2 bar
Ø intérieur du tuyau d'air	10 mm
Consommation d'air moyenne	150 l/min
Poids	1,1 kg

1	kg	1,1	CHF	337.00	1	019310030
---	----	-----	-----	--------	---	-----------

1932B10

Perceuse réversible



Vitesse à vide	1.800 tours/min
Capacité mandrin	1+10 mm
Puissance	0,44 kW
Filetage de la broche	3/8" - 24UNF
Filetage d'arrivée d'air	1/4" GAS
Pression d'utilisation	6,2 bar
Ø intérieur du tuyau d'air	10 mm
Consommation d'air moyenne	160 l/min
Poids	1,2 kg

kg 1,2 CHF 241.00 1 019320040

1932RS13

Perceuse réversible



Vitesse à vide	750 tours/min
Capacité mandrin	1,5+13 mm
Puissance	0,55 kW
Filetage de la broche	3/8" - 24UNF
Filetage d'arrivée d'air	1/4" GAS
Pression d'utilisation	6,2 bar
Ø intérieur du tuyau d'air	10 mm
Consommation d'air moyenne	160 l/min
Poids	1,4 kg

kg 1,4 CHF 307.00 1 019320043

1932B13

Perceuse réversible



Vitesse à vide	400 tours/min
Capacité mandrin	1,5+13 mm
Puissance	0,34 kW
Filetage de la broche	1/2" - 20UNC
Pression d'utilisation	1/4" GAS
Ø intérieur du tuyau d'air	6,2 bar
Consommation d'air moyenne	10 mm
Poids	1,6 kg
Peso	1,6 kg

kg 1,6 CHF 361.00 1 019320004

1933IH

Meuleuse droite haute puissance

• Fournie avec pinces de Ø 3 et 6 mm



Vitesse à vide	20.000 tours/min
Capacité pince	3 - 6 mm
Puissance	0,75 kW
Filetage d'arrivée d'air	1/4" GAS
Pression d'utilisation	6,2 bar
Ø intérieur du tuyau d'air	10 mm
Consommation d'air moyenne	370 l/min
Poids	800 g

g 800 CHF 273.00 1 019330006

1933ILH

Meuleuse droite longue haute puissance

• Fournie avec pinces de Ø 3 et 6 mm

CE



Vitesse à vide	20.000 tours/min
Capacité pince	3 - 6 mm
Puissance	0,75 kW
Filetage d'arrivée d'air	1/4" GAS
Pression d'utilisation	6,2 bar
Ø intérieur du tuyau d'air	10 mm
Consommation d'air moyenne	370 l/min
Poids	1,2 kg

kg 1,2 CHF 515.00 1 019330011

1933AN90-H

Meuleuse à renvoi d'angle haute puissance

• Fournie avec pinces de Ø 3 et 6 mm

CE



Vitesse à vide	15.000 tours/min
Capacité pince	3 - 6 mm
Puissance	0,75 kW
Filetage d'arrivée d'air	1/4" GAS
Pression d'utilisation	6,2 bar
Ø intérieur du tuyau d'air	10 mm
Consommation d'air moyenne	370 l/min
Poids	1,1 kg

kg 1,1 CHF 515.00 1 019330021

1933

Meuleuse droite

• Fournie avec pince de Ø 3 et 6 mm

CE



Vitesse à vide	25.000 tours/min
Capacité pince	3 - 6 mm
Puissance	0,20 kW
Filetage d'arrivée d'air	1/4" GAS
Pression d'utilisation	6,2 bar
Ø intérieur du tuyau d'air	10 mm
Consommation d'air moyenne	230 l/min
Poids	380 g

g 380 CHF 180.00 1 019330001

Beta
Quality Tools

1933I

Meuleuse droite

- Fournie avec pinces de Ø 3 et 6 mm

CE



Vitesse à vide	20.000 tours/min
Capacité pince	3 - 6 mm
Puissance	0,38 kW
Filetage d'arrivée d'air	1/4" GAS
Pression d'utilisation	6,2 bar
Ø intérieur du tuyau d'air	10 mm
Consommation d'air moyenne	260 l/min
Poids	670 g

g 670 CHF 204.00 1 019330005

1933L

Meuleuse droite longue

- Fournie avec pinces de Ø 3 et 6 mm

CE



Vitesse à vide	25.000 tours/min
Capacité pince	3 - 6 mm
Puissance	0,20 kW
Filetage d'arrivée d'air	1/4" GAS
Pression d'utilisation	6,2 bar
Ø intérieur du tuyau d'air	10 mm
Consommation d'air moyenne	270 l/min
Poids	670 g

g 670 CHF 229.50 1 019330015

1933IL

Meuleuse droite longue

- Fournie avec pinces de Ø 3 et 6 mm

CE



Vitesse à vide	20.000 tours/min
Capacité pince	3 - 6 mm
Puissance	0,38 kW
Filetage d'arrivée d'air	1/4" GAS
Pression d'utilisation	6,2 bar
Ø intérieur du tuyau d'air	10 mm
Consommation d'air moyenne	113 l/min
Poids	1,4 kg

kg 1,4 CHF 278.00 1 019330010

1933AN90

Meuleuse à renvoi d'angle

- Fournie avec pinces de Ø 3 et 6 mm

CE



Vitesse à vide	20.000 tours/min
Capacité pince	3 - 6 mm
Puissance	0,20 kW
Filetage d'arrivée d'air	1/4" GAS
Pression d'utilisation	6,2 bar
Ø intérieur du tuyau d'air	10 mm
Consommation d'air moyenne	230 l/min
Poids	510 g

g 510 CHF 229.50 1 019330020

1934BV

Nettoyeur à basse vitesse

- Fournie avec pinces de Ø 3 et 6 mm

CE



Vitesse à vide	3.700 tours/min
Capacité pince	3 - 6 mm
Puissance	0,37 kW
Filetage d'arrivée d'air	1/4" GAS
Pression d'utilisation	6,2 bar
Ø intérieur du tuyau d'air	10 mm
Consommation d'air moyenne	113 l/min
Poids	0,84 kg

g 840 CHF 248.00 1 019340000



1934MAV

Micro-meuleuse droite

CE



Vitesse à vide	56.000 tours/min
Capacité pince	3 mm
Puissance	0,04 kW
Filetage d'arrivée d'air	1/4" GAS BSPT
Pression d'utilisation	6,2 bar
Ø intérieur du tuyau d'air	4,5 mm
Consommation d'air moyenne	115 l/min
Poids	0,2 kg

g 205 CHF 212.50 1 019340010

1934MAV70

Micro-meuleuse droite à grande vitesse

CE



Vitesse à vide	70.000 tours/min
Capacité pince	3 mm
Puissance	0,08 kW
Filetage d'arrivée d'air	1/4" GAS BSPT
Pression d'utilisation	6,2 bar
Ø intérieur du tuyau d'air	4,5 mm
Consommation d'air moyenne	115 l/min
Poids	0,21 kg

g 210 CHF 353.00 1 019340030

1935F

Visseuse pneumatique réversible



Vitesse à vide	800 tours/min
Champ couple de serrage	4-16 Nm
Capacité vis	6-9 M
Porte-embouts	● 1/4"
Filetage d'arrivée d'air	1/4" GAS
Pression d'utilisation	6,2 bar
Ø intérieur du tuyau d'air	10 mm
Consommation d'air moyenne	150 l/min
Poids	1,3 kg

kg 1,3 CHF 337.00 1 019350045

1936/4A

Meuleuse à renvoi d'angle



Vitesse à vide	11.000 tours/min
Dimension de la meule	115 mm
Puissance	0,66 kW
Filetage de la broche	M14
Filetage d'arrivée d'air	1/4" GAS
Pression d'utilisation	6,2 bar
Ø intérieur du tuyau d'air	10 mm
Consommation d'air moyenne	390 l/min
Poids	1,77 kg

kg 1,8 CHF 556.00 1 019360024

1936/5A

Meuleuse à renvoi d'angle



Vitesse à vide	10.000 tours/min
Dimension de la meule	125 mm
Puissance	0,66 kW
Filetage de la broche	M14
Filetage d'arrivée d'air	1/4" GAS
Pression d'utilisation	6,2 bar
Ø intérieur du tuyau d'air	10 mm
Consommation d'air moyenne	390 l/min
Poids	1,9 kg

kg 1,9 CHF 556.00 1 019360025

1936/7A

Meuleuse à renvoi d'angle



Vitesse à vide	7600 giri/min
Dimension de la meule	180 mm
Puissance	1,3 kW
Filetage de la broche	M14
Filetage d'arrivée d'air	3/8" GAS
Pression d'utilisation	6,2 bar
Ø intérieur du tuyau d'air	13 mm
Consommation d'air moyenne	906 l/min
Poids	2,7 kg

kg 2,7 CHF 813.00 1 019360027

1937

Ponceuse orbitale rotative sans lubrification, en matériau composite

• Diamètre orbite 5 mm



Vitesse à vide	12.000 tours/min
Puissance	0,18 kW
Dimensions du plateau	150 mm
Diamètre orbite	5 mm
Filetage de la broche	5/16"-24
Filetage d'arrivée d'air	1/4" GAS
Pression d'utilisation	6,2 bar
Ø intérieur du tuyau d'air	10 mm
Consommation d'air moyenne	170 l/min
Poids	0,86 kg

kg 0,86 CHF 587.00 1 019370001

1937R/P

Plateau Ø 150 mm 6 trous pour 1937



1937R/P CHF 60.50 1 019370002

1937KC

Coffret mini ponceuse roto-orbitale

- Diamètre orbite 4 mm • 2 plateaux de ponçage Ø 50 mm et Ø 75 mm
- 10 disques de papier de verre abrasif Ø 50 mm avec grain 400, 600, 800
- 10 disques de papier de verre abrasif Ø 75 mm avec grain 400, 600, 800



Vitesse à vide	15000 tours/min
Puissance	0,25 kW
Dimensions du plateau	50 - 75 mm
Filetage de la broche	M6 x 1,0
Filetage d'arrivée d'air	1/4" GAZ
Pression d'utilisation	6,2 bars
Ø intérieur du tuyau d'air	10 mm
Consommation d'air moyenne	79 l/min
Poids ponceuse	0,64 kg
Poids kit	1,4 kg

kg 1,4 CHF 336.00 1 019370171



1937C...

Disques de papier de verre pour 1937KC



Ø mm	P	CHF		
50	400	20.00	1	019370175
50	600	20.00	1	019370176
50	800	20.00	1	019370177
75	400	25.50	1	019370178
75	600	25.50	1	019370179
75	800	25.50	1	019370180

* Les prix indiqués sont pour 10 pièces

1937KL

Mini polisseuse revolver orbitale

- Plateau de polissage Ø 75 mm
- 2 éponges pour lustrer Ø 90 mm - 1937/KL-DSB, 1937/KL-DSG
- Laine d'agneau Ø 90 mm - 1937/KL-DLA

CE



Vitesse à vide	3.200 tours/min
Puissance	0,25 kW
Dimensions du plateau	75 mm
Filetage de la broche	M6
Filetage d'arrivée d'air	1/4" GAS BSPT
Pression d'utilisation	6,2 bars
Ø intérieur du tuyau d'air	10 mm
Consommation d'air moyenne	91 l/min
Poids polisseuse	0,75 kg
Poids kit	1,8 kg

kg	CHF		
1,8	366.00	1	019370161

1937KL-D

Accessoires pour 1937KL



Ø mm	CHF		
1937KL-DLA 90	33.00	1	019370164
1937KL-DSB 90	33.00	1	019370165
1937KL-DSG 90	33.00	1	019370166

1937K...

Plateau pour 1937KC et 1937KL



Ø mm	1937KC	1937KL	CHF		
1937KC-RP 50	•		36.00	1	019370173
1937KL-RP 75	•	•	43.50	1	019370163

1937M

Ponceuse multifonction avec 16 accessoires

CE



Vitesse à vide	3.500 tours/min
Puissance	0,34 kW
Filetage d'arrivée d'air	1/4" GAS
Pression d'utilisation	6,2 bar
Ø intérieur du tuyau d'air	10 mm
Consommation d'air moyenne	113 l/min
Poids ponceuse	1,5 kg
Poids kit	4,5 kg

kg	CHF		
4,5	1.013.00	1	019370011

458x495x116 mm

1937M-01÷11

Accessoires pour 1937M



L mm	1937M-	CHF		
1937M-01 30		38.00	1	019370101
1937M-02 30		38.00	1	019370102
1937M-03 11		33.00	1	019370103
1937M-04 23		33.00	1	019370104
1937M-05 11		33.00	1	019370105
1937M-06 23		33.00	1	019370106
* 1937M-07 16		90.00	1	019370107
1937M-08 13	07	33.00	1	019370108
1937M-09 26	07	33.00	1	019370109
1937M-10 11	03, 05	33.00	1	019370110
1937M-11 23	01, 02, 04, 06	33.00	1	019370111

* Les prix indiqués sont pour 6 pièces

1937N10

Ponceuse à bande

CE



Vitesse à vide	20.000 tours/min
Puissance	0,37 kW
Dimensions de la bande	10x330 mm
Filetage d'arrivée d'air	1/4" GAS
Pression d'utilisation	6,2 bar
Ø intérieur du tuyau d'air	10 mm
Consommation d'air moyenne	374 l/min
Poids	0,9 kg

kg	CHF		
0,9	394.00	1	019370041

1937N10-GR

Bandes abrasives pour 1937N10



P	CHF		
1937N10-GR60 60	41.50	1	019370146
1937N10-GR80 80	41.50	1	019370148
1937N10-GR100 100	41.50	1	019370150
1937N10-GR120 120	41.50	1	019370152

Les prix indiqués sont pour 10 pièces

1937N20

Ponceuse à bande

CE



Vitesse à vide	16.000 tours/min
Puissance	0,45 kW
Dimensions de la bande	20x520 mm
Filetage d'arrivée d'air	1/4" GAS
Pression d'utilisation	6,2 bar
Ø intérieur du tuyau d'air	10 mm
Consommation d'air moyenne	400 l/min
Poids	1,6 kg

kg	CHF		
1,6	459.00	1	019370051

1937N20-GR

Bandes abrasives pour 1937N20



	P	CHF		
1937N20-GR60	60	54.00	1	019370156
1937N20-GR80	80	54.00	1	019370158
1937N20-GR100	100	54.00	1	019370160
1937N20-GR120	120	54.00	1	019370162

Les prix indiqués sont pour 10 pièces

1938

Couteau vibrant dépose-vitres

• Fourni avec 1 lame droite de 57 mm



Nombre d'oscillations à la minute	20.00
Filetage d'arrivée d'air	1/4" GAS
Pression d'utilisation	6,2 bar
Ø intérieur du tuyau d'air	6,5 mm
Consommation d'air moyenne	200 l/min
Poids	1,0 kg

kg	1,0	CHF	309.00		1	019380021
----	-----	-----	--------	--	---	-----------

1938R/L

Lames pour couteau vibrant dépose-vitres

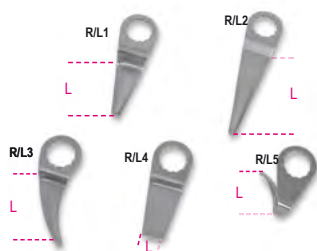

	L mm	CHF		
1938R/L1	57	26.00	1	019380041
1938R/L2	90	47.50	1	019380042
1938R/L3	30	29.00	1	019380043
1938R/L4	8	41.50	1	019380044
1938R/L5	36	47.00	1	019380045

1938R/S5

Jeu de 5 lames pour 1938

1938R/S5	CHF	191.50	1	019380055
----------	-----	--------	---	-----------

1940

Marteau burineur

• Fourni avec un ressort de retenue et un coupleur rapide à baïonnette pour forets 6 pans



Nombre de coups à la minute	3.500
Dimension de l'emmanchement	Ø 11 mm
Dimension du piston	19 mm
Longueur de la course	67 mm
Filetage d'arrivée d'air	1/4" GAS
Pression d'utilisation	6,2 bar
Ø intérieur du tuyau moyenne	8 mm
Consommation d'air moyenne	240 l/min
Poids	1,9 kg

kg	1,9	CHF	248.00		1	019400001
----	-----	-----	--------	--	---	-----------

1940/C6

Coffret marteau pneumatique avec 5 burins et accessoires

• Pour couper la tôle, les boulons et les corps, enlever les scories de soudage, les rivets, le plâtre et les carreaux
 • Assortiment dans une mallette à outils ABS pratique, comprenant:
 1 marteau à air article 1940
 1 burin plat article 1940SN
 1 burin de démolition article 1940ST
 1 burin à pointe ronde 1940SD
 1 burin biseauté article 1940SPS
 1 ciseau à tôle 1940SDT
 1 élément de ressort anti-retour 1940MT
 1 support à baïonnette pour burins hexagonaux



Coups par minute	3.500
Emmanchement	Ø 11 mm
dimension du piston	19 mm
longueur de course du piston	67 mm
Entrée d'air	1/4" GAS
Pression de travail	6,2 bar
Taille du tuyau interne (Ø)	8 mm
Consommation moyenne d'air	240 l/min
Weight	3.3 kg

kg	3,3	CHF	352.00		1	019400000
320x240x90 mm						

1940MT

Ressort de retenue pour 1940



1940MT	CHF	16.10	5	019400110
--------	-----	-------	---	-----------

1940S...

Burins pour marteau burineur 1940



1940SN	CHF	20.00	5	019400020
1940ST	20.00	5	019400021	
1940SD	20.00	5	019400022	
1940SPS	20.00	5	019400023	
1940SDT	20.00	5	019400024	

1940/S5

Jeu de 5 burins pour 1940



1940/S5	CHF	90.50	1	019400030
---------	-----	-------	---	-----------

1940E10

Marteau burineur

• Compatible avec burins à entraînement hexagonal de 10 mm
 • Fourni avec un ressort de retenue et un coupleur rapide à baïonnette



Nombre de coups à la minute	2.900
Dimension de l'emmanchement	Ø 10 mm
Dimension du piston	19 mm
Longueur de la course	67 mm
Filetage d'arrivée d'air	1/4" GAS
Pression d'utilisation	6,2 bars
Ø intérieur du tuyau d'air	10 mm
Consommation d'air moyenne	76 l/min
Poids	1,7 kg

kg	1,7	CHF	273.00		1	019400010
----	-----	-----	--------	--	---	-----------

1940E10/MT

Ressort de tenue pour 1940E10



1940E10/MT	CHF 2.15	5	019400112
------------	-------------	---	-----------

1940E10/S...

Burins pour marteau burineur 1940E10



1940E10/SN	CHF 13.80	5	019400040
1940E10/ST	13.80	5	019400041
1940E10/SD	13.80	5	019400042
1940E10/SPS	13.80	5	019400043
1940E10/SDT	13.80	5	019400044

1940E10/S5

Jeu de 5 burins pour marteau burineur 1940E10



1940E10/S5	CHF 69.00	1	019400050
------------	--------------	---	-----------

1942A

Scie alternative

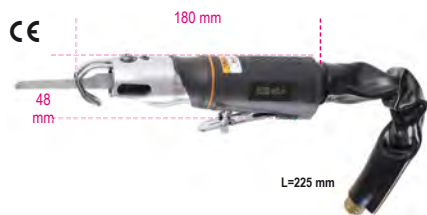

Nombre de cycles par minute	10.000
Longueur de la course	10 mm
Filetage d'arrivée d'air	1/4" GAS BSP
Pression d'utilisation	6,2 bar
Ø intérieur du tuyau d'air	8 mm
Consommation d'air moyenne	75 l/min
Poids	550 g

550	CHF 413.00	1	019420000
-----	---------------	---	-----------

1942LR

Lames Bimétal pour scie alternative 1942A



1942LR	CHF 9.55	5	019420032
--------	-------------	---	-----------

1944A

Dériveur à aiguilles axial

CE



Nombre de coups à la minute	3.800
Course du piston	33 mm
N°. aiguilles	19
Ø aiguille	3 mm
Filetage d'arrivée d'air	1/4" GAS
Pression d'utilisation	6,2 bar
Ø intérieur du tuyau d'air	10 mm
Consommation d'air moyenne	85 l/min
Poids	2,8 kg

2,8	CHF 465.00	1	019440011
-----	---------------	---	-----------

1944N

Dériveur à aiguilles



Nombre de coups à la minute	3800
Corse du piston	33 mm
N°. aiguilles	19
Ø aiguille	3 mm
Filetage d'arrivée d'air	1/4" GAS
Pression d'utilisation	6,2 bar
Ø intérieur du tuyau d'air	8 mm
Consommation d'air moyenne	85 l/min
Poids	2,7 kg

2,7	CHF 595.00	1	019440002
-----	---------------	---	-----------

1944AR

Jeu de aiguilles pour 1944N et 1944A



1944AR 2	Ø 2	n. 29	CHF 60.50	1	019440015
1944AR 3	3	19	47.00	1	019440005

1944PA

Plaques porte-aiguilles pour 1944N et 1944A



1944PA 2	Ø 2	N. 29	CHF 67.00	1	019440016
1944PA 3	3	19	51.00	1	019440006

1945S

Agrafeuse

• Utilise des agrafes type 80, section 0,95 x 0,65 mm (21 Gauge), longueur 4 - 16 mm, largeur 12,8 mm



Capacité du chargeur	157 pces
Filetage d'arrivée d'air	1/4" GAS
Pression d'utilisation	4,2 - 7 bar
Ø intérieur du tuyau d'air	8 mm
Consommation d'air (7 bar)	0,34 l/cycle
Poids	0,87 kg

0,9	CHF 253.00	1	019450000
-----	---------------	---	-----------

1945S/G...

Agrafes type 80, section 0,95x0,65 mm (21 Gauge), largeur 12,8 mm, pour 1945S



	L mm	CHF	
• 1945S/G4	4	23.40	1 019450004
1945S/G6	6	9.25	1 019450006
1945S/G8	8	10.00	1 019450008
1945S/G10	10	11.20	1 019450010
1945S/G12	12	12.50	1 019450012
1945S/G14	14	13.50	1 019450014
1945S/G16	16	14.90	1 019450016

Les prix indiqués sont pour 5.000 pièces
• Les prix indiqués sont pour 10.000 pièces



1945C

Agrafeuse-cloueuse

- Utilise des agrafes type 90 section 1,25 x 1,0 mm (18 Gauge), longueur 16-40 mm, largeur 5,8 mm
- Utilises des clous type B12 section 1,25 x 1,0 mm (18 Gauge), tête de 1,9 mm



Capacité du chargeur	100 pces
Filetage d'arrivée d'air	1/4" GAS
Pression d'utilisation	5 - 8 bar
Ø intérieur du tuyau d'air	8 mm
Consommation d'air (7 bar)	1,12 l/cycle
Peso	1,16 kg

kg	CHF	1	019450200
1,16	334.00		

1945C/G...

Agrafes type 90, section 1,25x1,0 mm (18 Gauge), longueur 5,8 mm, pour 1945C

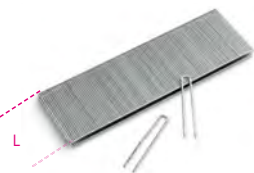

	L mm	CHF	1	019450216
1945C/G16	16	17.90		
1945C/G19	19	21.10		
1945C/G22	22	23.10		
1945C/G25	25	27.00		
1945C/G28	28	28.50		
1945C/G32	32	33.50		
1945C/G35	35	36.00		
1945C/G38	38	40.50		
1945C/G40	40	42.50		

Les prix indiqués sont pour 10.000 pièces

1945C/GP...

Clous type B12, section 1,25x1,0 mm (18 Gauge), tête de 1,9 mm, pour 1945C

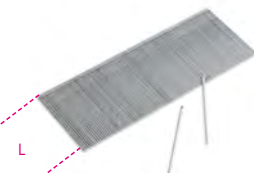

	L mm	CHF	1	019450255
1945C/GP15	15	9.35		
1945C/GP16	16	9.75		
1945C/GP20	20	11.20		
1945C/GP25	25	13.20		
1945C/GP30	30	15.40		
1945C/GP32	32	16.90		
1945C/GP35	35	18.10		
1945C/GP38	38	19.60		
1945C/GP40	40	20.20		
1945C/GP45	45	22.30		
1945C/GP50	50	24.60		

Les prix indiqués sont pour 10.000 pièces



1945P

Aiguilleur micropin/minibrad sans tête

- Utilise des pointeaux type B6, Ø 0,64 mm (23 Gauge), longueur 12 - 35 mm



Capacité du chargeur	145 pces
Filetage d'arrivée d'air	1/4" GAS
Pression d'utilisation	4 - 7 bar
Ø intérieur du tuyau d'air	8 mm
Consommation d'air (7 bar)	0,27 l/cycle
Poids	0,87 kg

kg	CHF	1	019450100
0,87	404.00		

1945P/S...

Pointeaux type B6, Ø 0,64 mm (23 Gauge), pour 1945P



	L mm	CHF	1	019450112
1945P/S12	12	10.90		
1945P/S15	15	12.00		
1945P/S18	18	13.00		
1945P/S20	20	15.10		
1945P/S21	21	15.40		
1945P/S22	22	15.80		
1945P/S25	25	16.90		
1945P/S30	30	19.40		
1945P/S35	35	22.00		

Les prix indiqués sont pour 10.000 pièces

1946T

Riveteuse

- Livrée avec des buses interchangeables pour rivets en acier, acier inoxydable, aluminium et cuivre de 2,4 - 3,2 - 4,0 - 4,8 mm



Puissance de traction	9.000 N
Longueur de la course	16 mm
Capacité maximum rivets	Ø acier inoxydable 4,8 mm
Filetage d'arrivée d'air	1/4" GAS
Pression d'utilisation	6,2 bar
Ø intérieur du tuyau d'air	8 mm
Consommation d'air	2,0 l/cycle
Poids	1,7 kg

kg	CHF	1	019460021
1,7	363.00		

1946C4,8

Riveteuse

- Aspiration automatique
- Fournie assemblée pour rivets en acier, acier inoxydable, aluminium et cuivre, de 2,4 - 3,2 - 4,0 - 4,8 mm



Puissance de traction	8.900 N
Longueur de la course	15 mm
Capacité maximum rivets	Ø acier inoxydable 4,8 mm
Filetage d'arrivée d'air	1/4" GAS
Pression d'utilisation	6,2 bar
Ø intérieur du tuyau d'air	10 mm
Consommation d'air	2,6 l/cycle
Poids	1,5 kg

kg	CHF	1	019460006
1,5	785.00		



1946C7,8

Riveteuse

- Aspiration automatique
- Fournie assemblée pour rivets en acier, acier inoxydable, aluminium et cuivre, de 4,8 - 5,6 - 6,4 - 7,8 mm

CE



Puissance de traction	16.900 N
Longueur de la course	22,5 mm
Capacité maximum rivets	Ø acier inoxydable 7,8 mm
Filetage d'arrivée d'air	1/4" GAS
Pression d'utilisation	6,2 bar
Ø intérieur du tuyau d'air	10 mm
Consommation d'air	4,9 l/cycle
Poids	1,8 kg

kg	CHF	1	019460008
1,8	1.235.00		

1946C/T...

Têtes pour rivets structurels



Ø mm	CHF	1	019460016
1946C/T4,8	47.00		
1946C/T6,4	47.00		

1946KF

Riveteuse pour embouts filetés

- Fournie assemblée pour rivets filetés en acier, acier inox, aluminium et cuivre, M4, M5, M6, M8

CE



Puissance de traction	14.235 N
Longueur de la course	7 mm
Capacité maximum rivets	Ø acier inoxydable M8
Filetage d'arrivée d'air	1/4" GAS
Pression d'utilisation	6,2 bar
Ø intérieur du tuyau d'air	10 mm
Consommation d'air	2,1 l/cycle
Poids riveteuse	2,1 kg
Poids kit	3,4 kg

kg	CHF	1	019460012
3,4	2.600.00		

1946KF/M...

Embouts de rechange pour 1946KF



	CHF	1	019460124
1946KF/M4	87.00		
1946KF/M5	87.00		
1946KF/M6	87.00		
1946KF/M8	83.00		

1947

Pistolet à silicone

- Pistolet pneumatique pour silicones, colles et scellants moyenne densité
- Prise en charge cartouches standard (210 x 50 mm) dures et souples

CE



Dimension du tuyau	210x50 mm
Capacité de la cartouche	350 ml
Filetage d'arrivée d'air	1/4" GAS
Pression d'utilisation	4,8 bars
Ø intérieur du tuyau d'air	10 mm
Consommation d'air moyenne	120 l/min
Poids	1,1 kg

kg	CHF	1	019470001
1,1	88.00		

1947H

Pistolet à silicone

- Pistolet pneumatique pour l'extrusion de silicones et mastics en cartouches standard plastique ou métal
- Prise en charge cartouches standard (215/218 x 50/51 mm) dures et souples
- Flux du matériel contrôlé par la gâchette
- Réducteur de pression intégré

CE



Dimension du tuyau	210x50 mm
Capacité de la cartouche	300/310 ml
Filetage d'arrivée d'air	1/4" GAS
Pression d'utilisation	4 ÷ 8 bars
Ø intérieur du tuyau d'air	2,5 mm
Consommation d'air moyenne	120 l/min
Poids	750 g

g	CHF	1	019470011
750	307.00		

1947G

Pistolet de graissage pneumatique

- Tête moulée sous pression en aluminium
- Manche ergonomique avec partie saillante pour atteindre les espaces restreints
- Vanne en cuivre pour une longue durée
- Fonctionne avec cartouches de 400 g ou graisse en vrac jusqu'à 500 cc
- Dimensions du tuyau : 54 (interne) x 26 mm
- Filetage d'arrivée d'air: 1/4" GAZ
- Pression d'utilisation: 4÷10 bars
- Poids: 1,9 kg

CE



CHF	1	019470051
216.50		

1947G2

Pistolet de graissage 2 en 1



Dimensions du tuyau	54 (interne) x 276 mm
Filetage d'arrivée d'air	1/4" GAS BSP
Pression d'utilisation	3÷10 bar
poids	2,2 kg

CHF	1	019470060
222.50		



1948

Crayon à graver

- Il peut graver les matériaux comme l'acier, l'acier inoxydable, l'aluminium, le verre, la pierre et la céramique

CE



Nombre de coups à la minute	3.500 + 3.800
Dureté maximum	60 HRC
Filetage d'arrivée d'air	1/4" GAS
Pression d'utilisation	6,2 bars
Consommation d'air moyenne	50 l/min
Poids	150 g

g	CHF	1	019480001
150	405.00		

1948PR

Pointe de rechange au carbure de tungstène pour 1948

- Dureté maximum : 60 HRC



CHF	1	019480005
152.50		

1949U5

Soufflette progressive avec 5 buses

- Corps en matériau composite à haute résistance, antichoc
- 3 buses en acier 100/160/320 mm avec embout de protection en caoutchouc anti-rayures
- 1 buse "Turbo" en nylon renforcé avec fibres de verre et embout de sécurité
- 1 buse orientable 100 mm nylon renforcé avec fibres de verre
- Doté de système de fixation rapide



Embout cuivre fileté	1/4" GAS
Pression d'utilisation	10 bar
Pression d'utilisation maximum	15 bar
Consommation d'air moyenne	280 l/min
Température d'utilisation	-10°C ÷ 80°C
Poids	93 g

g	CHF	1	019490030
93	47.50		

1949U5/A

Buse en acier 100 mm avec embout de protection en caoutchouc anti-rayures pour 1949U5 - 1949P



CHF	1	019490131
9.75		

1949U5/B

Buse en acier 160 mm avec embout de protection en caoutchouc anti-rayures pour 1949U5 - 1949P



CHF	1	019490132
9.85		

1949U5/C

Buse en acier 320 mm avec embout de protection en caoutchouc anti-rayures pour 1949U5 - 1949P



CHF	1	019490133
12.70		

1949U5/D

Buse pivotante 100 mm en nylon renforcé de fibres de verre pour 1949U5 - 1949P



CHF	1	019490134
9.25		

1949U5/E

Buse "Turbo" en nylon renforcé avec fibres de verre avec embout de sécurité



CHF	1	019490135
4.60		

1949U5/F

Buse à éventail plate, en nylon renforcé avec fibres de verre, pour 1949U5 et 1949P



CHF	1	019490136
5.85		

1949U5/G

Buse OSHA, en nylon renforcé avec fibres de verre, pour 1949U5 et 1949P



CHF	1	019490137
4.40		

1949BC

Soufflette progressive avec buse en caoutchouc

- Corps en matériau composite haute résistance, antichoc
- Buse en caoutchouc anti-écaillage, remplaçable



Embout aluminium fileté	1/4" GAS
Pression d'utilisation	6-8 bar
Pression d'utilisation maximum	15 bar
Consommation d'air moyenne	87 l/min
Température d'utilisation	-20°C ÷ 70°C
Poids	120 g

g	CHF	1	019490022
120	23.60		

1949BC/RU

5 buses en caoutchouc pour 1949BC



CHF	1	019490122
29.00		

1949P

Mini soufflette progressive

- Corps en en matériau composite à haute résistance, antichoc
- Système de fixation rapide des buses
- Flux d'air réglable par rotation de l'écrou



Embout cuivre fileté	1/4" GAS
Pression d'utilisation	6÷8 bar
Pression d'utilisation maximum	15 bar
Consommation d'air moyenne	280 l/min
Température d'utilisation	-10°C ÷ 85°C
Poids	70 g

g	CHF	1	019490031
70	30.50		

1949T

Soufflette progressive télescopique

- Corps en matériau composite haute résistance, antichoc
- Tube télescopique en acier orientable : 165 mm ± 300 mm

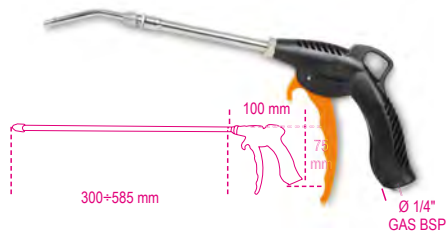

Embout aluminium fileté

Pression d'utilisation

Pression d'utilisation maximum

Consommation d'air moyenne

Température d'utilisation

Poids

1/4" GAS

6÷8 bar

15 bar

144 l/min

-20°C ÷ 70°C

190 g

CHF 38.00 1 019490040

1949F2

Soufflette progressive

- En matière plastique composite haute résistance, antichoc, antiéraflure et isolé thermiquement
- La soupape spéciale et la sensibilité du levier assurent une ouverture progressive du circuit et une optimisation du flux de l'air
- Embout équipé d'un cône de sécurité en plastique pour une manipulation en toute sécurité lorsqu'il n'est pas utilisé



Embout cuivre fileté

Pression d'utilisation

Pression d'utilisation maximum

Température d'utilisation

Poids

1/4" GAS

4-8 bar

12 bar

-20 °C ÷ 70 °C

125 g

CHF 21.80 1 019490028

1949GPA

gonfleur de pneus

- Corps enduit de caoutchouc antichoc
- levier de commande métallique
- pression de service: 0,5÷12 bar, 7÷174 psi
- fonction de relâchement de pression
- fonction de mesure de pression
- longueur du tuyau: 58 cm
- Rotation du tuyau à 360°
- Entrée d'air 1/4 »



CHF 139.50 1 019490018

1949DGT/2

gonfleur de pneu numérique

- corps enduit de caoutchouc antichoc
- levier de commande métallique
- pression de service: 0,5÷12 bar, 7÷174 psi
- 4 unités de mesure, bar/psi/kpa/kgf
- écran LCD rétroéclairé
- résolution: 0.05 bar
- auto-mise hors tension après 1,5 minute
- longueur du tuyau: 58 cm
- Rotation du tuyau à 360°
- alimentation: 2 piles AAA
- Entrée d'air 1/4 »



CHF 167.50 1 019490021

1949GPN

Pistolet pour gonflage de pneus corps en ABS

- Manomètre certifié CE avec échelle 0,7÷12 bar (gradins par 1/10e bar)
- Les deux boutons servo-assistés permettent de gonfler (+) et dégonfler (-) le pneu avec précision et rapidité
- Fourni avec certificat d'étalonnage
- Livré avec coquille de protection antichoc et embout d'attelage
- Fourni avec raccord fileté 1/4" GAZ
- Prise d'air pivotante pour tuyau en caoutchouc Ø 7 mm



CHF 295.00 1 019490011

1949M

Pistolet de gonflage pneumatique



CHF 98.00 1 019490400

1950BZK

Talonneur à pneus

- La poignée secondaire activée par un bouton permet de ne jamais lâcher l'outil pendant l'utilisation
- Capacité du réservoir : 18 litres
- Pression de fonctionnement : 3-8 bars
- Pression maximale du réservoir : 16 bars
- Soupape de sécurité pour surpression
- Manomètre avec échelle graduée
- Embout en plastique pour éviter d'abimer la jante



CHF 407.00 1 019500078

1949R

Soufflette pour nettoyer les radiateurs

- Equipée de 5 trous perpendiculaires à la poignée permettant d'éliminer la saleté des radiateurs



CHF 88.50 1 019490050



1951

Pistolet de lavage

- Indiqué pour le nettoyage de tapisserie d'auto, moquette, sièges et coffres



Vitesse à vide	
Capacité réservoir	1 L
Filetage d'arrivée d'air	1/4" GAS
Pression d'utilisation	6,2 bar
Ø intérieur du tuyau d'air	8 mm
Consommation d'air moyenne	110 l/min
Poids	650 g

	CHF		
650	190.50	1	019510051

1951A

Pistolet de lavage avec aspiration

- Indiqué pour le nettoyage de tapisserie d'auto, moquette, sièges et coffres
- À utiliser avec les détergents prévus à cet effet
- Réservoir de 1 l
- Équipé de robinet pour le réglage de la sortie du liquide contenu dans le réservoir
- Fourni avec tuyau ondulé de 1,8 m



Capacité réservoir	1 l
Filetage d'arrivée d'air	1/4" GAS
Pression d'utilisation	6,2 bars
Ø intérieur du tuyau d'air	8 mm
Consommation d'air moyenne	120 l/min
Poids	800 g

	CHF		
800	309.00	1	019510101

1952

Pistolet de vernissage professionnel

- Corps en aluminium moulé sous pression avec traitement de protection en nickel chimique noir.
- Godet en nylon avec dispositif ramasse-goutte, filet 3/8M BSP.
- Filetage sur le corps 1/4" BSP GAS cylindrique.
- Régulateur de pression et de débit d'air.
- Régulateur du jet, de rond à éventail.
- Régulateur de la quantité de vernis.
- Fourni avec clé de service pour la maintenance.

CE



	Ø		CHF		
1952 1,2	1,2		204.00	1	019520012
1952 1,5	1,5		204.00	1	019520015
1952 1,8	1,8		204.00	1	019520018
1952 2,0	2,0		204.00	1	019520020

1900S

enrouleur automatique de tuyau à ressort, corps en plastique antichoc, pour une utilisation avec de l'air ou de l'eau

- pression de service max. : 15 bar
- tuyau en polyuréthane tressé
- cadre en polypropylène
- dispositif de fixation automatique du tuyau à la longueur requise
- le mécanisme de rack peut être désactivé pour garder le tuyau tiré
- plage de température de fonctionnement de l'eau: -5 °C / +50 °C
- fourni avec un support pivotant à 180° et un support de connexion rapide supplémentaire

CE



D1xD	L	Ø GAS	CHF		
mm	m	BSP			
8x12	10	1/4"	220.00	1	019000080

1900M

enrouleur de tuyau à ressort automatique, corps en plastique antichoc, à utiliser avec de l'air ou de l'eau

- pression de service max. : 15 bar
- tuyau en polyuréthane tressé
- cadre en polypropylène
- dispositif de fixation automatique du tuyau à la longueur requise
- le mécanisme de rack peut être désactivé pour garder le tuyau tiré
- plage de température de fonctionnement de l'eau: -5 °C / +50 °C
- fourni avec un support pivotant à 180° et un support de connexion rapide supplémentaire

CE



D1xD	L	Ø GAS	CHF		
mm	m	BSP			
8x12	15	1/4"	301.00	1	019000085
10x14	15	3/8"	314.00	1	019000115

1914

Tuyau spiralé en polyuréthane 98 Shore, extensible

- Pression d'utilisation maximum 12 bars



L	D1xD	Ø GAS	CHF		
m	mm	BSP			
4	5x8	1/4"	32.00	1	019140054
6	5x8	1/4"	38.00	1	019140056
10	5x8	1/4"	48.50	1	019140060

1915B

Tuyau spiralé en polyuréthane 95 Shore, extensible sur 9 m

- Pression d'utilisation maximum 10 bars

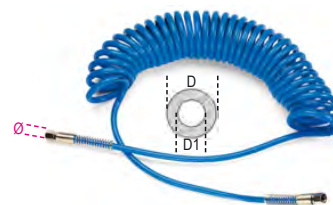

D1xD	Ø GAS	CHF		
mm	BSP			
6,5x10	1/4"	56.00	1	019150011
8x12	1/4"	66.50	1	019150012
11x16	3/8"	107.00	1	019150013

Beta

1915C

Tuyau spiralé en polyuréthane 95 Shore, extensible sur 12 m

• Pression d'utilisation maximum 10 bars



D1xD	Ø GAS	CHF		
mm	BSP			
6,5x10	1/4"	66.50	1	019150014
8x12	1/4"	82.00	1	019150015
11x16	3/8"	132.00	1	019150016

1915C/L

Tuyau spiralé en polyuréthane 95 Shore, extensible sur 15 m

• Pression d'utilisation maximum 10 bars



D1xD	Ø GAS	CHF		
mm	BSP			
8x12	1/4"	104.50	1	019150115
11x16	3/8"	178.00	1	019150116

1915D

Tuyau en polyuréthane armé 95 Shore, longueur 9 m

• Pression d'utilisation maximum 15 bars



D1xD	Ø GAS	CHF		
mm	BSP			
8x12	1/4"	66.50	1	019150017
11x16	3/8"	104.50	1	019150018

1915E

Tuyau en polyuréthane armé 95 Shore, longueur 12 m

• Pression d'utilisation maximum 15 bars



D1xD	Ø GAS	CHF		
mm	BSP			
8x12	1/4"	88.00	1	019150019
11x16	3/8"	131.50	1	019150020

1915E/XL

Bobine en polyuréthane armé 95 Shore, longueur 50 m

• Pression d'utilisation maximum 15 bars



D1xD	Ø GAS	CHF		
mm	BSP			
8x12	1/4"	303.00	1	019150519
11x16	3/8"	506.00	1	019150520

1916I

Embout rapide profil Italien, filetage mâle, embout cylindrique BSP



Ø GAS	CHF		
BSP			
1/4"	3.85	5	019160001
3/8"	4.35	5	019160002

1916G

Embout rapide profil Européen, filetage mâle, embout conique BSPT



Ø GAS	CHF		
BSPT			
1/4"	3.85	5	019160005
3/8"	5.10	5	019160010
1/2"	5.65	5	019160012

1916GF

Embout rapide profil Italien, filetage femelle, embout cylindrique BSP



Ø GAS	CHF		
BSP			
1/4"	3.85	5	019160055
3/8"	4.35	5	019160060

1916GFE

Embout rapide profil Européen, filetage femelle, embout conique BSPT



Ø GAS	CHF		
BSPT			
1/4"	3.85	5	019160075
3/8"	5.10	5	019160082
1/2"	5.65	5	019160084

1916JM

Embout rapide profil Asiatique, filetage mâle, embout conique BSPT



Ø GAS	CHF		
BSPT			
1/4"	5.40	1	019160406
3/8"	5.65	1	019160410

1916JF

Embout rapide profil Asiatique, filetage femelle, embout cylindrique BSP



Ø GAS	CHF		
BSPT			
1/4"	5.40	1	019160456
3/8"	5.65	1	019160460

1916P

Embout rapide profil Italien avec masque tuyau



D1xD	CHF		
mm			
6x14	5.10	5	019160256
8x17	5.45	5	019160258
10x19	7.30	5	019160260

1916S

embout rapide profile Italien avec ressort spirale

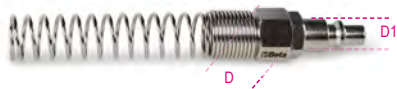

D1xD mm	CHF	🔧	📄
6x8	5.10	5	019160306
8x10	5.40	5	019160308
10x12	6.80	5	019160310

1917M

Raccord universel à billes avec manchon antichoc, filetage mâle, embout cylindrique BSP

• Accouplable à les embouts 1916l et 1916G



Ø GAS BSP	CHF	🔧	📄
1/4"	13.80	5	019170001
3/8"	13.80	5	019170003
1/2"	14.80	5	019170004

1917F

Raccord universel à billes avec manchon antichoc, filetage femelle, embout cylindrique BSP

• Couplage à les embouts 1916l et 1916G



Ø GAS BSP	CHF	🔧	📄
1/4"	14.30	5	019170005
3/8"	13.80	5	019170010
1/2"	15.30	5	019170014

1917JM

Raccord universel à billes pour profil Asiatique, filetage mâle, embout cylindrique BSP



Ø GAS BSP	CHF	🔧	📄
1/4"	22.90	1	019170406
3/8"	22.90	1	019170410
1/2"	24.70	1	019170412

1917JF

Raccord à billes pour profil Asiatique, filetage femelle, embout cylindrique BSP



Ø GAS BSP	CHF	🔧	📄
1/4"	22.90	1	019170456
3/8"	22.90	1	019170460

1917RG

Raccord tournant universel

- En aluminium, filetage femelle, embout cylindrique BSP, filetage mâle, embout cylindrique BSP
- Couplage à tous les embouts avec profil Italien et Européen
- Rotation libre même en absence d'air connecté



Ø GAS BSP	CHF	🔧	📄
1/4"	30.00	1	019170252

1917SP

Raccord universel à billes avec masque tuyau



D1xD mm	CHF	🔧	📄
6x14	14.80	5	019170206
8x17	15.40	5	019170208
10x19	17.60	5	019170210

1917ST

Raccord universel à billes avec ressort spirale



D1xD mm	CHF	🔧	📄
6x8	13.80	5	019170306
8x10	13.90	5	019170308
10x12	15.80	5	019170310

1918

Raccord cannelé, filetage mâle



D1 mm	Ø GAS BSP	CHF	🔧	📄
6	1/8"	3.10	3	019180106
8	1/8"	3.10	3	019180108
6	1/4"	3.35	3	019180116
8	1/4"	3.55	3	019180118
10	1/4"	3.55	3	019180120
10	3/8"	4.05	3	019180130
12	3/8"	4.15	3	019180132
10	1/2"	5.50	3	019180140
12	1/2"	5.65	3	019180142

1918N

Barrette de connexion avec filet conique BSPT



Ø GAS	Ø1 GAS	CHF	🔧	📄
1/4"	1/4"	3.55	5	019180300
3/8"	3/8"	4.15	5	019180310
1/2"	1/2"	5.65	5	019180320

1918R

Barrette de réduction avec filet conique BSPT



Ø GAS	Ø1 GAS	CHF	🔧	📄
1/4"	3/8"	4.05	5	019180200
3/8"	1/2"	5.50	5	019180210

1919FE1/4

Filtre régulateur lubrificateur



Filetages d'arrivée d'air	1/4" GAS BSPT
Filetage du manomètre	1/8" GAS BSPT
Débit maximum	750 l/min
Pression d'entrée maximum	9,5 bar
Pression d'utilisation	0,5 - 8,5 bar
Température d'utilisation	5 - 60 °C
Capacité de filtrage	5 micron
Capacité cuves	15 cl air / 25 cl huile
Poids	700 g

g	CHF	🔧	📄
700	138.00	1	019190200

1919RB-FE1/4

Paire de cuves de recharge pour 1919FE1/4



1919RB-FE1/4 CHF 30.00 1 019190210

1919RF-FE1/4

Manomètre de recharge pour 1919FE1/4



1919RF-FE1/4 CHF 8.15 1 019190230

1919RM-FE1/4

Élément filtrant de recharge pour 1919FE1/4



1919RM-FE CHF 17.60 1 019190220

1919F1/4

Filtre régulateur lubrificateur

Ø 1/4"



Filetages d'arrivée d'air 1/4" GAS BSPT
Débit maximum 1000 l/min
Pression d'entrée maximum 9,5 bar
Pression d'utilisation 0,5 - 8,5 bar
Température d'utilisation 5 - 60 °C
Capacité de filtrage 5 µm
Capacité cuves 60 cl air / 90 c huile
Poids 1,3 kg

1919F1/4 CHF 218.00 1 019190250

1919F3/8

Filtre régulateur lubrificateur

Ø 3/8"



Filetages d'arrivée d'air 3/8" GAS BSPT
Débit maximum 1350 l/min
Pression d'entrée maximum 9,5 bar
Pression d'utilisation 0,5 - 8,5 bar
Température d'utilisation 5 - 60 °C
Capacité de filtrage 5 µm
Capacité cuves 60 cl air / 90 cl huile
Poids 1,3 kg

1919F3/8 CHF 218.00 1 019190350

1919F1/2

Filtre régulateur lubrificateur

Ø 1/2"



Filetages d'arrivée d'air 1/2" GAS BSPT
Débit maximum 2500 l/min
Pression d'entrée maximum 9,5 bar
Pression d'utilisation 0,5 - 8,5 bar
Température d'utilisation 5 - 60 °C
Capacité de filtrage 5 µm
Capacité cuves 60 cl air / 90 cl huile
Poids 1,3 kg

1919F1/2 CHF 218.00 1 019190450

1919RB-F

Paire de cuves pour filtres 1919F - 1/4", 3/8" et 1/2"



1919RB-F CHF 38.50 1 019190510

1919RF-F

Élément filtrant de recharge pour 1919F - 1/4", 3/8" et 1/2"



1919RF-F CHF 15.30 1 019190530

1919RM-F

Manomètre de recharge pour filtres 1919F - 1/4", 3/8" and 1/2"



1919RM-F CHF 22.70 1 019190520

1919ML

Mini-lubrificateur



Ø	L	Ø	CHF	1	019190030
1/4"	63	36	28.00	1	019190030
3/8"	63	36	30.50	1	019190032

1919SC

Mini-séparateur de condensation



Ø	L	Ø	CHF	1	019190035
1/4"	80	40	36.00	1	019190035

1919L

Huile lubrifiante ISO 32

Densité à 20°C 875 Kg/m³
Viscosité à 40°C 32 cSt
Inflammabilité COC 210°C



1919L CHF 24.70 5 019190050

SACOCHE ET SACS À DOS EN TISSU TECHNIQUE

- **FONCTIONNEL**
- **ROBUSTE**
- **LONGÉVITÉ**

Ce sont les trois caractéristiques de la gamme de sacs en tissu technique de Beta. Les sacoches et les sacs à dos de Beta sont fabriqués dans un tissu technique robuste, résistant à l'abrasion et à l'usure, avec des fonds et des coutures renforcés, se traduisant par une fiabilité et une longévité.

Chaque sacoche présente des caractéristiques particulières, conçues pour différentes applications en optimisant l'espace (poches zippées, poignées télescopiques, protège-roues, bretelles renforcées, et pochettes transparentes pour documents ne sont que quelques-unes des particularités de chaque sac et sac à dos.) Un soin minutieux des détails, la variété et une attention particulière au transport des outils en toute sécurité rendent ces produits adéquats pour chaque métier.



VALISES À OUTILS EN POLYPROPYLÈNE

Beta propose une large gamme de valises techniques répondant à tous les besoins ! Les valises à outils et les trolleys de Beta sont fabriqués à partir de polypropylène robuste, épais, antichoc et résistant à la corrosion, conçu pour résister à une utilisation intensive (par exemple à basse température).

Choisissez le produit qui correspond le mieux à vos exigences de travail parmi

le chariot classique, à roulettes, équipé de serrures TSA pour un déplacement en toute sécurité, la version aluminium ou étanche. La plupart des valises et trolleys Beta sont également disponibles avec des assortiments d'outils répondant à différents domaines d'applications : électronique, hydraulique, nautisme et maintenance.



2001/B26

Trousse en tissu avec 26 outils



2001/B26 CHF 299.00 1 020010215

55 6x7 - 8x9 - 10x11 - 12x13 - 14x15 - 16x17 mm
 96N/SC9 1,5 - 2 - 2,5 - 3 - 4 - 5 - 6 - 8 - 10 mm
 1044F 250 mm
 1128BMX 145 mm
 1150 180 mm
 1201E 3x75 - 4x100 - 5,5x150 mm
 1202E PH1x80 - PH2x100 mm
 1370 300 g
 1692 2 m
 1770A 9 mm

2001/BV CHF 70.00 1 020010051

2001/BZV

trousse en tissu technique vide

- Double poignée supérieure pour une confort optimal
- Grande poche avant pour documents avec fermeture éclair
- Bande velcro à l'arrière, pour fixer la valise à outils à la poignée du chariot
- 20 compartiments à outils pratiques (6 poches et 14 bandes élastiques)
- Boucles pour marteau
- La bandoulière C9 / RT peut également être incluse (vendue séparément)



2001/BZV CHF 64.00 1 020010151

380x290x60 mm - 675 g



2001/BZ24 MQ

trousse en tissu technique avec assortiment de 24 outils pour électriciens



2001/BZ24 MQ CHF 436.00 1 020010154

	n.
1128BMX	1
1150MQ 180 mm	1
42 8-10-13-17-19 mm	5
1274MQ 3x100 - 4x100 - 5,5x125 mm	3
1272MQ PH0x60 - PH1x80 - PH2x100 mm	3
96BP/SC9 1,5-2-2,5-3-4-5-6-8-10 mm	9
1253	1
1082MQ 160 mm	1

2001/BZ27 VU

trousse en tissu technique avec assortiment de 27 outils pour la maintenance générale



2001/BZ27 VU CHF 353.00 1 020010157

	n.
1128BMX	1
1150 180 mm	1
42 7-8-10-13-17-19 mm	6
1201E 3x75 - 4x100 - 5,5x150 mm	3
1202E PH0x60- PH1x80 - PH2x100 mm	3
96/SC9 1,5-2-2,5-3-4-5-6-8-10 mm	9
1370 300 g	1
1048N 250 mm	1
1692/5 5 m	1
1771 18 mm	1

2002/BV6

Portefeuille d'outils enroulable en polyester durable, vide

- Avec 6 compartiments à outils pratiques et de tailles différentes
- La poignée centrale en tissu renforcé facilite le transport
- Avec rabat intérieur empêchant les outils de sortir
- Coutures de renforcement dans tout le périmètre du portefeuille
- Double fermeture velcro
- Dimensions à l'ouverture : 175 x 240 mm



2002/BV6 CHF 11.30 1 020020000

2002/BVL6

Portefeuille d'outils enroulable en polyester durable, vide

- Avec 6 compartiments à outils pratiques et de tailles différentes
- La poignée centrale en tissu renforcé facilite le transport
- Avec rabat intérieur empêchant les outils de sortir
- Coutures de renforcement dans tout le périmètre du portefeuille
- Double fermeture velcro
- Dimensions à l'ouverture : 220 x 290 mm



2002/BVL6 CHF 14.40 1 020020010

2002/BV7-ZIP

Portefeuille d'outils enroulable en polyester durable, vide

- Avec 7 compartiments pratiques de tailles différentes et une petite poche à outils avec fermeture à glissière
- La poignée centrale en tissu renforcé facilite le transport
- Avec rabat intérieur empêchant les outils de sortir
- Coutures de renforcement dans tout le périmètre du portefeuille
- Double fermeture velcro
- Dimensions à l'ouverture : 355 x 220 mm



2002/BV7-ZIP CHF 26.00 1 020020060

2002/BV8

Portefeuille d'outils enroulable en polyester durable, vide

- Avec 8 compartiments à outils pratiques et de tailles différentes
- La poignée centrale en tissu renforcé facilite le transport
- Avec rabat intérieur empêchant les outils de sortir
- Coutures de renforcement dans tout le périmètre du portefeuille
- Double fermeture velcro
- Dimensions à l'ouverture : 395 x 360 mm



2002/BV8 CHF 14.40 1 020020020

2002/BV9

Portefeuille d'outils enroulable en polyester durable, vide

- Avec 9 compartiments à outils pratiques et de tailles différentes
- La poignée centrale en tissu renforcé facilite le transport
- Avec rabat intérieur empêchant les outils de sortir
- Coutures de renforcement dans tout le périmètre du portefeuille
- Double fermeture velcro
- Dimensions à l'ouverture : 325 x 290 mm



2002/BV9 CHF 14.40 1 020020030

2002/BV12

Portefeuille d'outils enroulable en polyester durable, vide

- Avec 12 compartiments à outils pratiques et de tailles différentes
- La poignée centrale en tissu renforcé facilite le transport
- Avec rabat intérieur empêchant les outils de sortir
- Coutures de renforcement dans tout le périmètre du portefeuille
- Double fermeture velcro
- Dimensions à l'ouverture : 650 x 355 mm



2002/BV12 CHF 23.90 1 020020040

2002/BV13

Portefeuille d'outils enroulable en polyester durable, vide

- Avec 13 compartiments à outils pratiques et de tailles différentes
- La poignée centrale en tissu renforcé facilite le transport
- Avec rabat intérieur empêchant les outils de sortir
- Coutures de renforcement dans tout le périmètre du portefeuille
- Double fermeture velcro
- Dimensions à l'ouverture : 330 x 190 mm



2002/BV13 CHF 14.40 1 020020050

2002/BV42

Portefeuille d'outils enroulable en polyester durable, vide

- Avec 42 compartiments à outils pratiques et de tailles différentes :
 - 18 élastiques et 24 poches dont une à rabat avec fermeture à scratch
- La poignée centrale en tissu renforcé facilite le transport
- Accrochage mural au moyen d'anneaux métalliques
- Coutures de renforcement dans tout le périmètre du portefeuille
- Fermeture robuste avec boucle à double clip
- Dimensions à l'ouverture : 595 x 535 mm



2002/BV42 CHF 35.50 1 020020070

2005MPU

pochette à outils, vide, en nylon, avec ceinture

- Cinq grandes poches à outils
- Une poche à ciseaux avant
- Boucle avec crochet pour ruban adhésif
- Ceinture réglable (70 ÷ 120 cm) Dimensions: 155x285x80 mm



2005MPU CHF 37.00 1 020050060

2005PA/D

Porte-outils poche double vide en nylon, avec ceinture



2005PA/D CHF 87.50 1 020050000

2005PA/E

pochette à outils, vide, en nylon, avec ceinture

- Deux grandes poches avec bandes d'outils élastiques
- Deux poches avant en ciseaux
- Deux compartiments latéraux pratiques avec:
 - poche gauche avec crochet métallique robuste pour rubans à mesurer
 - double poche droite avec sac avec cordon de serrage et fermeture à glissière
- Boucle avec crochet pour ruban adhésif
- Ceinture réglable (70 ÷ 120 cm) Dimensions: 260x250x190 mm



2005PA/E CHF 58.00 1 020050030

2005PA/S

Porte-outils en nylon, avec ceinture



2005PA/S CHF 44.00 1 020050020

2009N/BV

Sacoche de maintenance industrielle en cuir



2009N/BV CHF 370.00 1 020090200

530x220x190 mm

2009ID

Composition avec sacoche de plombiers



2009ID CHF 1,123.00 1 020091013
(2009N/BV+5980ID)

2028/VV

Valise porte-outils en polypropylène

- 2 panneaux porte-outils
- Fond intérieur avec séparateurs amovibles
- Double fermeture avec combinaison



2028/VV CHF 306.00 1 020280010

480x190x400 mm

2028E

Composition avec valise porte-outils pour l'électronique et la microtechnique



2028EL/A CHF 1,485.00 1 020281014
(2028/VV+5980EL/A)

2028ET/A CHF 1,505.00 1 020281018
(2028/VV+5980ET/A)

2029/VV

Valise porte-outils en polypropylène à grande épaisseur, profilée en aluminium

2 panneaux porte-outils
Fond avec séparateurs amovibles et réglables
Fournie avec bandoulière
2 serrures avec clé



2029/VV	CHF 438.00			1 020290000
≡ 480x227x408 mm				

2029E

Composition avec valise porte-outils pour l'électronique et la microtechnique



2029 BG MQ (2029/VV+5980MQ)	CHF 2,660.00			1 020291257
2029ET/B (2029/VV+5980ET/B)	2,075.00			1 020291021
2029EL/B (2029/VV+5980EL/B)	2,095.00			1 020291017

2032/TV

Valise porte-outils en matière plastique

2 panneaux porte-outils
Poche porte-outils
Fond intérieur avec séparateurs amovibles



2032/TV	CHF 563.00			1 020320110
≡ 450x200x400 mm				

2032/TE

Composition avec valise porte-outils pour l'électronique et la microtechnique



2032TET/A (2032/TV+5980ET/A)	CHF 1,760.00			1 020321328
2032TEL/A (2032/TV+5980EL/A)	1,740.00			1 020321314

2033L/VV

Boîte à outils murale, en aluminium, vide

- Très résistant aux chocs
- Finition sans écaillement
- Poignée ergonomique avec poignée en caoutchouc
- Double fermeture avec combinaison
- 2 panneaux d'outils avec bandes élastiques
- Fond intérieur avec cloisons amovibles



2033L/VV	CHF 479.00			1 020330250
≡ 470x203x373 mm				

2033L

boîte outils en aluminium avec assortiments d'outils pour la maintenance électronique et électrotechnique



2033LEL/A (2033L/VV+5980EL/A)	CHF 1,655.00			1 020331224
2033LEL/B (2033L/VV+5980EL/B)	2,140.00			1 020331225
2033LET/B (2033L/VV+5980ET/B)	2,120.00			1 020331237

2036/TV

Valise porte-outils en polypropylène grande épaisseur, en aluminium profilé

2 panneaux porte-outils
Poignée télescopique
Roues avec roulements à billes



2036/TV	CHF 660.00			1 020360000
≡ 480x267x408 mm				

2036E

Composition avec chariot porte-outils pour l'électronique et la microtechnique



2036TET/B (2036/TV+5980ET/B)	CHF 2,300.00			1 020361223
2036EL/B (2036/TV+5980EL/B)	2,320.00			1 020361218

2037/TV

Valise porte-outils en polypropylène, avec 4 roues pivotantes

Extrêmement résistante aux chocs. Indiquée pour le transport d'outils en avion.
2 panneaux porte-outils amovibles.
Poche porte-documents intégrée.
4 roues pivotantes amovibles qui permettent la manutention horizontale de la valise.
2 bacs de rangement inc



2037/TV	CHF 813.00			1 020370000
≡ 482x295x478 mm				

2038/TV

Valise porte-outils en polypropylène grande épaisseur

- Extrêmement résistante aux chocs.
- En aluminium profilé
- 2 serrures homologuées TSA avec clé
- 2 panneaux porte-outils amovibles.
- Grande poignée télescopique et grandes roues avec roulements à billes
- 2 poignées (1 latérale) ergonomiques revêtues de caoutchouc
- Fond grande capacité
- Poche porte-documents
- 3 petits tiroirs de rangement



2038/TV CHF 1,078.00 1 020380000

≡ 430x375x525 mm

2041UC

Valise Utility Case avec 33 outils



2041UC CHF 448.00 1 020410215

- 55 6x7 - 8x9 - 10x11 - 12x13 - 14x15 - 16x17 mm
- 96/SC9 1,5 - 2 - 2,5 - 3 - 4 - 5 - 6 - 8 - 10 mm
- 111 200 mm
- 1048V 250 mm
- 1128BMX 145 mm
- 1150 180 mm
- 1201E 2,5x50 - 3x75 - 4x100 - 5,5x100 - 6,5x150 mm
- 1202E PH0x60 - PH1x80 - PH2x100 mm
- 1370 300 g
- 1692 3m
- 1771 170 mm
- 1833S 70 Lumen / 140 mm
- 1639NS-N 25m
- 1696 200 mm

≡ 535x282x87 mm - 4,5 Kg

2051N

Valise en polypropylène antichoc avec composition de 55 outils pour maintenance nautique



2051N CHF 1,043.00 1 020510215

- 42 7 - 8 - 10 - 12 - 13 - 14 - 17 - 19 mm
- 55AS 3/8x7/16 - 1/2x9/16 - 5/8x11/16"
- 956C □1/2 - 16 - 20,8 mm
- 1048 250 mm
- 1084BM 160 mm
- 1128BMX 145 mm
- 1150BM 180 mm
- 1166BM 160 mm
- 1201E ●3x75 - 4x100 - 5,5x150 - 6,5x150 mm
- 1202E ●PH1x80 - PH2x100 mm
- 1390 Ø 35 mm
- 1490/2 ø max 240 mm
- 96/SC9 ○1,5÷10 mm
- 1737 145 mm
- 1778X
- BMN1436 3,6 x 140 mm
- BMESB1925NE 25 m
- 111 200 mm
- 920A ○ 10 - 12 - 13 - 14 - 17 - 19 mm
- 920AS ○ 7/16 - 1/2 - 9/16 - 11/16 - 7/8"
- 920/22 255 mm - □1/2 - ■1/2
- 920/25 □1/2 - ■1/2
- 920/42 ■1/2
- 920/55 ■1/2

≡ 585x393x92 mm - 9 kg

2055HB

Valise avec 24 outils



2055HB CHF 270.00 1 020550215

- 55 6x7 - 8x9 - 10x11 - 12x13 mm
- 96N/SC9 1,5 - 2 - 2,5 - 3 - 4 - 5 - 6 - 8 - 10 mm
- 1128BMX 145 mm
- 1150 180 mm
- 1048V 250 mm
- 1201E 3x75 - 4x100 - 5,5x100 mm
- 1202E PH0x60 - PH1x80 - PH2x100 mm
- 1370 300 g
- 1692 3m

≡ 373x275x70 mm - 3 Kg

2080/V6

Valise type organizer avec 6 bacs de rangement amovibles et séparateurs réglables



2080/V6 CHF 50.00 1 020800060

2080/V6-U

Bac de rangement amovible pour valise type organizer 2080/V6



2080/V6-U CHF 3.85 1 020800066

≡ 90x60x50 mm

2080/D10

Jeu de 10 séparateurs réglables pour valise type organizer 2080/V6



2080/D10	CHF 10.20	1	020800070
----------	--------------	---	-----------

2080/V12

Valise type organizer avec 12 bacs de rangement amovibles



2080/V12	mm 300x145x330	CHF 78.50	1	020800000
----------	-------------------	--------------	---	-----------

2080/V12-...

Bac de rangement amovible pour valise type organizer 2080/V12



2080/V12-S	CHF 4.85	3	020800013
2080/V12-M	CHF 7.25	2	020800015
2080/V12-L	CHF 12.50	1	020800020

C3

Mini sac à outils en tissu technique

Caractéristiques principales:

- 1 poche extérieure avant avec fermeture éclair
- 2 poches latérales avec module de rangement
- 1 poche arrière pratique avec fermeture Velcro
- 1 panneau porte-outils intérieur amovible, avec des bandes élastiques des deux côtés
- Interface USB pour charger les appareils mobiles
- Complet avec bandoulière



C3	CHF 84.50	1	021030000
----	--------------	---	-----------

310x110x320 mm - 890 g

C4 - 2104

Sac seau porte-outils en tissu technique

Panneau intérieur porte-outils amovible
Poches et élastiques porte-outils intérieurs et extérieurs
Base rigide imperméable avec pieds en caoutchouc
Bandoulière fournie



C4	CHF 142.50	1	021040000
2104VU/0	CHF 658.00	1	021041122

330x260x360 mm - 2,5 kg

C5S

Sac à dos porte-outils en polyester résistant

- Double poignée sur la partie supérieure centrale du sac à dos pour une prise sûre et équilibrée
- Deux grandes poches frontales
- Deux grandes poches intérieures et deux bandes velcro supplémentaires
- Trousse pratique enroulable composée de 4 panneaux porte-outils
- Bretelles renforcées réglables
- Charge maximale : 15 kg



C5S	CHF 72.50	1	021050100
-----	--------------	---	-----------

310x120x390 mm - 0,9 Kg

C5 - 2105

Sac à dos porte-outils en tissu technique



C5	CHF 203.50	1	021050000
2105VU/0	CHF 719.00	1	021051122

400x200x500 mm - 2,5 Kg

C6T - 2106

Sac à dos porte-outils en tissu technique, avec roues



C6T	CHF		
2106T/VU0	289.00	1	021060010
(C6T+5915VU/0)	805.00	1	021061123
≡ 360x200x480 mm - 📦 4,5 kg			

C7 - 2107

Sacoche porte-outils en tissu technique

2 panneaux porte-outils intérieurs amovibles
Poche intérieure porte-PC
2 poches extérieures avant
Fond intérieur en matière plastique avec séparateurs amovibles



C7	CHF		
2107VU/2	301.00	1	021070000
(C7+5915VU/2)	846.00	1	021071112
2107VU/3	1,460.00	1	021071114
(C7+5915VU/3)			
≡ 480x165x380 mm - 📦 3,5 kg			

C8 - 2108

Chariot porte-outils en tissu technique



C8	CHF		
2108VU/1	340.00	1	021080000
(C8+5915VU/1)	965.00	1	021081022
≡ 470x280x380 mm - 📦 4 kg			

C8B

Chariot porte-outils en tissu technique pour électriciens

Structure rigide
Poignée télescopique de transport
4 roues pivotantes
1 panneau porte-outils intérieur amovible
Poche frontale avec porte-badge
Double fond avec bac de rangement compris
2 poches extérieures latérales
2 crochets porte-sonde tire-fils
Manche inclinable pour faciliter l'accès aux outils
Possibilité de fermeture avec cadenas (non compris)



C8B	CHF		
	274.00	1	021080300
≡ 380x250x430 mm - 📦 4,7 kg			

C9 - 2109

Sacoche porte-outils en tissu technique

- Base rigide
- Poches intérieures et extérieures pour le rangement des outils
- Poche extérieure avec fermeture éclair pour plus de sécurité
- Poche refermable à fermeture facile pour objets personnels
- Double fond
- Double-sangles porte-niveaux
- Bandoulière de transport



C9	CHF		
2109VU/1	164.50	1	021090000
(C9+5915VU/1)	789.00	1	021091022
2109VU/3	1,320.00	1	021091024
(C9+5915VU/3)			
≡ 550x280x320 mm - 📦 2,6 kg			

C9/RT

bandoulière pour C4,C7,C9,C10,C10S,C11 e C12



C9/RT	CHF		
	20.30	1	021090900

C10 - 2110

Boîte à outils en tissu technique

Structure rigide
Double fond. Le fond peut être enlevé pour augmenter la capacité du sac
Manche inclinable pour faciliter l'accès aux outils
Élastiques porte-outils, poches intérieures et extérieures
Doublure de couverture
Bac de rangement compris dans le double fond



C10	CHF		
2110VU/1	206.50	1	021100000
(C10+5915VU/1)	831.00	1	021101031
2110VU/3	1,365.00	1	021101034
(C10+5915VU/3)			
2110VU/AS	1,480.00	1	021101036
(C10+5915VU/AS)			
≡ 520x220x250 mm - 📦 3,3 kg			

C10S - 2110S

Boîte à outils en tissu technique

Structure rigide

Double fond. Le fond peut être enlevé pour augmenter la capacité du sac

Manche inclinable pour faciliter l'accès aux outils

Élastiques porte-outils, poches intérieures et extérieures

Doubleure de couverture

Bac de rangement compris dans le double fond



	CHF		
C10S	162.50	1	021100001
2110SVU/1 (C10S+5915VU/1)	787.00	1	021101041
2110SVU/3 (C10S+5915VU/3)	1,320.00	1	021101044

≡ 420x220x250 mm - 📦 2,3 kg

C11 - 2111

Boîte à outils en tissu



	CHF		
C11	120.00	1	021110000
2111VU/1 (C11+5915VU/1)	745.00	1	021111031
2111VU/3 (C11+5915VU/3)	1,275.00	1	021111034

≡ 410x230x250 mm - 📦 2 kg



C12 - 2112

Sacoche porte-outils en tissu technique

Panneau intérieur porte-outils amovible

Élastiques porte-outils et grandes poches intérieures et extérieures

La sacoche s'ouvre à l'avant pour faciliter l'accès aux outils sur le lieu de travail

Base rigide imperméable avec pieds en caoutchouc

Prévue pour être utilisée avec chariot porte-outils C8



	CHF		
C12	261.00	1	021120000
2112ET/A (C12+5980ET/A)	1,460.00	1	021121028
2112ET/B (C12+5980ET/B)	1,905.00	1	021121029
2112VU/5 (C12+5915VU/5)	1,730.00	1	021121056

≡ 500x270x350 mm - 📦 5 kg

C13

Coffre porte-outils avec roues, en polypropylène haute résistance

- Adapté pour l'utilisation en plein air
- Résistant aux chocs et aux agents chimiques
- Prédiposition pour fermeture avec cadenas (non inclus)
- Équipé de deux serrures
- Deux roues pour un déplacement horizontal du coffre
- Fourni avec un bac de rangement amovible à verrouiller à l'intérieur dans deux positions
- Plaque d'identification porte-nom



	CHF		
C13	410.00	1	021130000

≡ 806x350x467 mm - 📦 7,2 kg

C14

Chariot porte-outils en polypropylène avec 4 tiroirs

- Structure en polypropylène à injection qui garantit une grande résistance aux chocs.
- La partie avant, protégée par le couvercle, accueille 4 tiroirs 470x255 mm extractibles :
1 tiroir hauteur 30 mm
2 tiroirs hauteur 60 mm
1 tiroir hauteur 90 mm
- Serrure centralisée avant permettant de fermer simultanément les deux couvercles, supérieur et avant.
- Deux poignées latérales
- 4 roues résistantes arrière
- Plateau supérieur amovible
- Panneau porte-outils intégré dans le couvercle
- 3 bacs de rangement inclus
- Plaque d'identification porte-nom
- Prédiposition pour la fermeture avec cadenas TSA



	CHF		
C14	1,049.00	1	021140000
2114VU/M (C14+5914VU/M)	2,435.00	1	021141011

≡ 585x390x457 mm - 📦 10 kg

CP15 - 2115

Boîte à outils en matière plastique avec plateau et bacs de rangement amovibles

- 1 couvercle de rangement intégré dans le couvercle
- 2 bacs de rangement amovibles avec séparateurs réglables
- 1 récipient interne avec séparateurs réglables



	CHF		
CP15	64.00	1	021150201
2115PVU/1 (CP15+5915VU/1)	688.00	1	021151232
2115PVU/2 (CP15+5915VU/2)	609.00	1	021151234

≡ 445x240x250 mm - 📦 2 kg



CP15L - 2115

Boîte à outils longue en matière plastique avec plateau et bacs de rangement

- 3 bacs de rangement intégrés dans le couvercle avec séparateurs réglables
- 1 récipient interne avec séparateurs réglables



	CHF		
CP15L	87.00	1	021150202
2115PL-VU/1 (CP15L+5915VU/1)	712.00	1	021151242
2115PL-VU/3 (CP15L+5915VU/3)	1,245.00	1	021151245

558x277x270 mm - 2,5 kg

2115PI/BIKE-HOME

Composition de 28 outils



	CHF		
2115PI/BIKE-HOME	346.00	1	021150098

- 96BP/SC9
- 3935
- 3969K3
- 42 8-9-10-13-14 mm
- 42SLIM 15 mm
- 1082G 160 mm
- 1150G 180 mm
- 1201E 3x75 - 5,5x150 mm
- 1202E PH0x60 - PH2x100 mm
- 3991

- BMESB1925NE 25 m
- BMM1436 3,6 x 140 mm

558x277x270 mm - 4,3 kg



2115P L-MQ32

Composition de 32 outils isolés pour autos hybrides, coffret en matière plastique, avec plateau en mousse compacte



	CHF		
2115PL-MQ32	1,535.00	1	021150332

- 920MQ/55A
- 89MQ 10-12 mm
- 850MQ 1/4"
- 860TX/A10 T7-T8-T9-T10-T15-T20-T25-T27-T30-T40
- 920MQ/A 8-10-12-13-14-17-19 mm
- 920MQ/21 125mm
- 920MQ/22 250mm
- 1048MQ250 250mm
- 1150MQ 180mm
- 1164MQ160 160mm
- 1272MQ 4.5X80-6X100mm
- 1274MQ 3X100-4X100-5.5X125
- 1995MQ/G2 G2
- CP15L

C16 - 2116

Boîte à outils en matière plastique avec bac plastique interne, vide



	CHF		
C16	142.00	1	021160000
2116VU/1 (C16+5915VU/1)	766.00	1	021161102
2116VU/3 (C16+5915VU/3)	1,300.00	1	021161105

500x260x260 mm - 2,5 kg

CP17 - CP17L - 2117

Boîte à outils en acier inoxydable et en matière plastique avec plateau amovible



CP17
500x200x220 mm



CP17L
575x245x265 mm

	CHF		
CP17	119.00	1	021170500
2117P-VU/1 (CP17+5915VU/1)	744.00	1	021171042
2117P-VU/3 (CP17+5915VU/3)	1,275.00	1	021171045
CP17L	171.00	1	021170502
2117L-VU/1 (CP17L+5915VU/1)	796.00	1	021171142
2117PL-VU/3 (CP17L+5915VU/3)	1,330.00	1	021171145

C18 - 2118

Boîte à outils simple, métallique



	CHF		
C18	56.50	1	021180001
2118VU/1 (C18+5915VU/1)	681.00	1	021181032

450x200x100 mm - 3 kg



C19 - 2119 - C19L - 2119L

Boîte à outils 3 cases, métallique



C19

≡ 450x200x160 mm



C19L

≡ 550x200x160 mm

	CHF		
C19	74.50	1	021190001
2119VU/3 (C19+5915VU/3)	1,230.00	1	021191025
C19L	95.50	1	021190002
2119L-VU/3 (C19L+5915VU/3)	1,250.00	1	021191125

C20 - C20L - 2120

Boîte à outils 5 cases, métallique



C20

≡ 450x200x210 mm



C20L

≡ 550x200x210 mm

	CHF		
C20	104.50	1	021200001
2120VU/2 (C20+5915VU/2)	650.00	1	021201061
2120VU/3 (C20+5915VU/3)	1,260.00	1	021201063
2120VU/4 (C20+5915VU/4)	1,605.00	1	021201064
2120VU/AS (C20+5915VU/AS)	1,375.00	1	021201068
C20L	114.50	1	021200002
2120L-VU/2 (C20L+5915VU/2)	660.00	1	021201161
2120L-VU/3 (C20L+5915VU/3)	1,270.00	1	021201163
2120L-VU/4 (C20L+5915VU/4)	1,610.00	1	021201164
2120L-VU/AS (C20L+5915VU/AS)	1,385.00	1	021201168

C20TSS

Boîte à outils 5 cases en acier inoxydable AISI 304



	CHF		
C20TSS	377.00	1	021203001

≡ 450x200x210 mm - 4kg

C22B

Coffre porte-outils, en tôle



C22B O

≡ 720x320x310 mm



C22BM O

≡ 850x360x350 mm



C22BL O

≡ 1010x410x400 mm

	CHF		
C22B-O	298.00	1	022000150
C22BM-O	342.00	1	022000160
C22BL-O	456.00	1	022000170

C22B O: 13 kg
C22BM O: 20 kg
C22BL O: 26 kg

C22W

Coffre porte-outils en tôle d'acier, avec doublage intérieur en mélaminé pour une meilleure protection du coffre et des outils



C22W-O

≡ 690x300x360 mm



C22WL-O

≡ 990x300x360 mm

	CHF		
C22W-O	331.00	1	022000269
C22WL-O	430.00	1	022000299

C22W O: 15 kg
C22WL O: 28 kg

C22P

Coffre porte-outils de chantier, en tôle

poignées encastrables invisibles
patins surélevés pour déplacement avec chariot élévateur
double fermeture antieffraction pour cadenas (non inclus)



C22PM O

≡ 915x540x430 mm



C22PL O

≡ 1220x720x615 mm

	CHF		
C22PM-O	887.00	1	022000240
C22PL-O	1,370.00	1	022000245

C22PM O: 39 kg
C22PL O: 67 kg



C99

Combo est le système modulaire de Beta, composé de **3 différents types de coffrets robustes porte-outils**, conçus pour ranger parfaitement et en toute sécurité vos outils de travail. Les coffret peuvent être aisément unis entre eux **par un simple clic**, au moyen d'un système de fermeture latérale à enclenchement.

Le système Beta Combo C99 est compatible avec le standard L-BOXX de Sortimo®.

C99

Système modulaire complet BETA COMBO

Les coffrets porte-outils peuvent être aisément unis entre eux par un simple clic, au moyen d'un système de fermeture latérale à enclenchement.

Composé de :

- Chariot ultracompact pliable avec poignée télescopique C99P (485x520x1095 mm)
- Coffret porte-outils en ABS C99V1 (445x358x152 mm)
- Coffret porte-outils en ABS C99V2 (445x358x254 mm)
- Coffret porte-outils en ABS avec 2 bacs de rangement portables C99V3/2C (445x358x322 mm)



C99

CHF 858.00 1 099000010

C99V0

Coffret porte outils en ABS, avec couvercle transparent - Vide

Les coffrets porte outils en ABS peuvent être facilement assemblés les uns aux autres par un simple clic, grâce au mécanisme d'encliquetage latéral fonctionnel.

Caractéristiques principales:

- Couvercle transparent en polycarbonate robuste pour une identification rapide du contenu
- Dimensions extérieures: 445x358x118 mm
- Max. capacité de charge intérieure: 25 kg
- Peut être cadenassé
- Poids: 2,5 kg

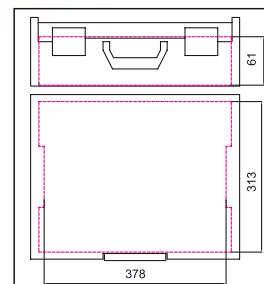

C99V0

CHF 139.00 1 099000202

C99V0-P12

Coffret porte outils en ABS, avec couvercle transparent - + kit 18 bacs
- Vide

Les coffrets porte outils peuvent être facilement assemblés les unes aux autres par un simple clic, grâce au mécanisme d'encliquetage latéral fonctionnel.

Caractéristiques principales:

- Couvercle transparent en polycarbonate robuste pour une identification rapide du contenu
 - Particulièrement adapté pour transporter des petits objets, y compris des vis, des écrous, des rondelles, des rivets et des chevilles
 - Livré complet avec kit de 18 bacs fourre-tout:
- 2 plateaux rouges, 52x52 mm
3 plateaux jaunes, 104x52 mm
2 plateaux bleus, 104x104 mm
1 plateau vert, 104x156 mm
2 plateaux orange, 208x52 mm
2 plateaux gris, 312x71 mm et 6 cloisons réglables
- Dimensions extérieures: 445x358x118 mm
 - Max. capacité de charge intérieure: 25 kg
 - Peut être cadenassé
 - Poids: 3,2 kg

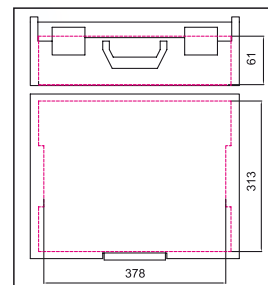

C99V0-P12

CHF
197.50 1 099000200

C99P12-V0

Kit de 18 bacs pour boîtes à outils C99V0

Contenu du kit :

- 2 plateaux rouges, 52x52 mm
- 3 plateaux jaunes, 104x52 mm
- 2 plateaux bleus, 104x104 mm
- 1 plateau vert, 104x156 mm
- 2 plateaux orange, 208x52 mm
- 2 plateaux gris, 312x71 mm, et 6 cloisons réglables



C99P12-V0

CHF
58.00 1 099000499

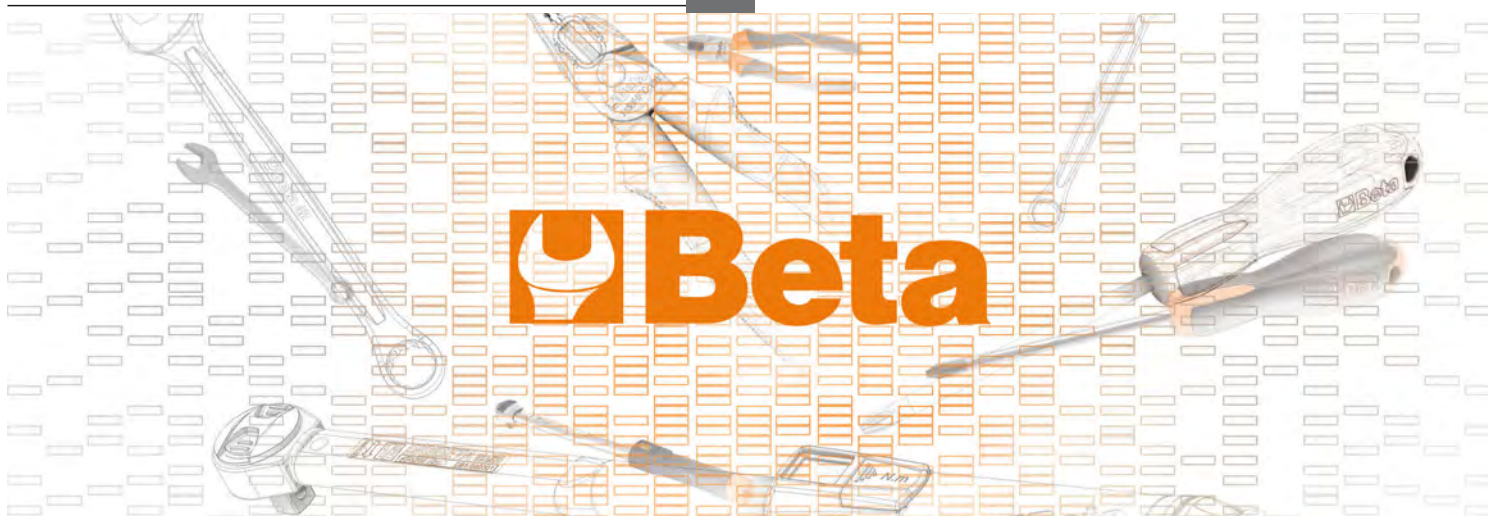

C99V1

Coffret porte-outils COMBO en ABS

Les coffrets porte-outils peuvent être aisément unis entre eux par un simple clic, au moyen d'un système de fermeture latérale à enclenchement.

Caractéristiques principales :

- Dimensions extérieures : 445x358x152 mm
- Capacité de charge max. interne : 25 kg
- Prédiposition pour fermeture avec cadenas
- Poids : 2,2 kg

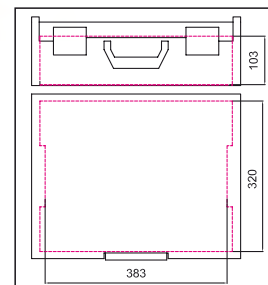

C99V1

CHF 141.50 1 099000250

C99V2

Coffret porte-outils COMBO en ABS

Les coffrets porte-outils peuvent être aisément unis entre eux par un simple clic, au moyen d'un système de fermeture latérale à enclenchement.

Caractéristiques principales :

- Dimensions extérieures : 445x358x254 mm
- Capacité de charge max. interne : 25 kg
- Poids : 2,8 kg

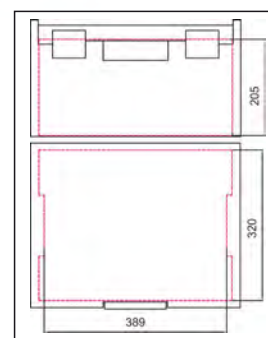

C99V2

CHF 157.00 1 099000350



C99V3/2C

Coffret porte-outils COMBO en ABS avec 2 bacs de rangement portables

Les coffrets porte-outils peuvent être aisément unis entre eux par un simple clic, au moyen d'un système de fermeture latérale à enclenchement.

Caractéristiques principales :

- Dimensions extérieures : 445x358x322 mm
- Capacité de charge max. interne : 25 kg
- Équipé de 2 bacs de rangement C99C-V3 vides
- Poids : 5,6 kg

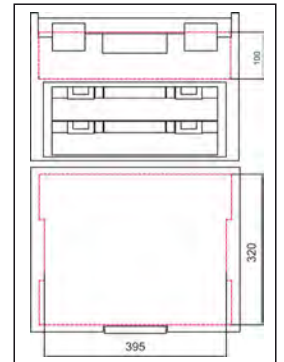

C99V3/2C

CHF 301.00 1 099000450

C99C-V3

Coffret porte-outils COMBO portable

Couvercle transparent pour identifier rapidement le contenu

Poignée intégrée

Dimensions extérieures : 367x316x72 mm

Poids : 0,9 kg

Accessoires :

- bac de rangement à 7 compartiments C99T-V3
- Jeu de 17 bacs de rangement C99P-V3

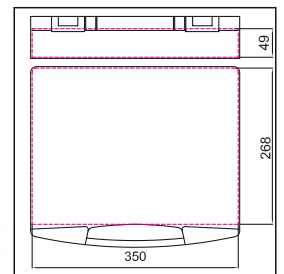

C99C-V3

CHF 48.50 1 099000496

C99P

Chariot pliable COMBO en aluminium

Caractéristiques principales :

- Chariot ultracompact pliable en aluminium anodisé
- Branche avec poignée télescopique
- Dimensions ouvert : 485x520x1195 mm
- Dimensions fermé : 485x60x905 mm
- Dimensions base inclinable 485x350 mm
- Deux roues anti-crevaison



C99P

CHF 259.00 1 099000101

C99PC

Revêtement interne pour couvercle coffrets C99V1 et C99V3/2C

Indispensable en association avec les plateaux thermoformés pour éviter que le contenu ne sorte des compartiments ou se mélange pendant le transport.



C99PC

CHF 22.80 1 099000491

C99T

Bac de rangement à 4 compartiments pour coffrets C99V1 et C99V3/2C



C99T

CHF 33.00 1 099000492

C99M

Insert souple pré-coupé en cubes pour coffrets COMBO C99VI, C99V2 et C99V3/2C

Facile à former pour créer des compartiments sûrs et sur mesure pour tous les types d'outils à ranger.

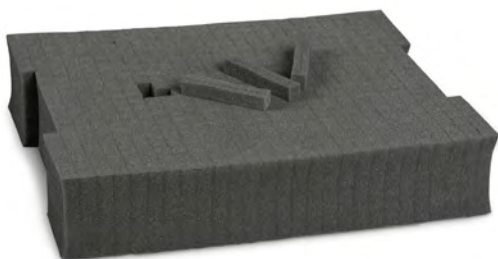

C99M

CHF 57.00 1 099000494

C99T-V3

Bac de rangement à 7 compartiments pour boîtes à outils C99C-V3



C99T-V3

CHF 16.60 1 099000497

C99P-V3

Jeu de 17 bacs de rangement pour boîtes à outils C99C-V3

Composition :

- 6 bacs rouges 52x52 mm
- 2 bacs jaunes 104x52 mm
- 3 bacs gris 78x260 mm et 6 séparateurs



C99P-V3

CHF 46.00 1 099000498

C99PP

panneau d'outils pour les boîtiers COMBO

- avec 6 poches et 11 bandes d'outils élastiques
- fourni complet avec des crochets pour fixer le panneau dans le couvercle du boîtier



C99PP

CHF 61.50 1 099000489



RSC22

coffre à outils portable avec 3 tiroirs

Caractéristiques principales:

- 3 tiroirs (588x277 mm) avec glissières à roulement à billes: 1 tiroir, 50 mm de haut 2 tiroirs, 70 mm de haut.
- Serrure centralisée avant.
- Poignées latérales rétractables pour faciliter la manipulation.

19 kg



RSC22-O



RSC22-A



RSC22-R



h	max
50 mm	25 kg
70 mm	25 kg

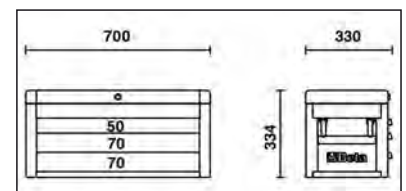
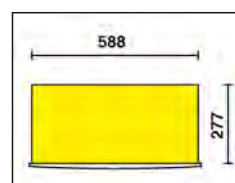

		CHF		
RSC22-O	RAL 2011	583.00	1	022003001
RSC22-R	RAL 3000	583.00	1	022003003
RSC22-A	RAL 7016	583.00	1	022003007

RSC23

coffre à outils portable avec 5 tiroirs

Caractéristiques principales:

- 5 tiroirs (588x277 mm) avec glissières à roulement à billes: 2 tiroirs, 50 mm de haut 3 tiroirs, 70 mm de haut.
- Serrure centralisée avant.
- Poignées latérales rétractables pour faciliter la manipulation.

📦 26 kg



RSC23-A



RSC23-R



RSC23-O



h	max
50 mm	25 kg
70 mm	25 kg

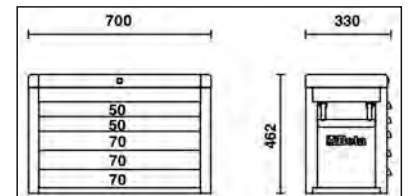
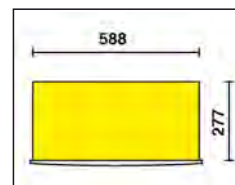

		CHF	📦	📄
RSC23-O	RAL 2011	739.00	1	023003001
RSC23-R	RAL 3000	739.00	1	023003003
RSC23-A	RAL 7016	739.00	1	023003007

CD23S

Chariot Caddy

Caractéristiques principales :

- Socle en ABS permettant de poser les coffres C22S, C23S, C23SC, C23ST
- Poignée démontable pouvant être rangée sous le châssis.
- 4 roues, Ø 100 mm: 2 fixes et 2 mobiles (dont une équipée d'un frein).
- Capacité de charge maximale : 250 kg.

📦 14 kg



		CHF	📦	📄
CD23S		340.00	1	023000610

RSC23C

coffre à outils portable avec 8 tiroirs

Caractéristiques principales:

- 8 tiroirs (588x277 mm) avec glissières à roulement à billes : 4 tiroirs, 50 mm de haut 3 tiroirs, 70 mm de haut 1 tiroir, 100 mm de haut.
- Serrure centralisée avant.
- Poignées latérales rétractables pour faciliter la manipulation.

📦 28 kg



RSC23C-A



RSC23C-R



RSC23C-O



h	max
50 mm	25 kg
70 mm	25 kg

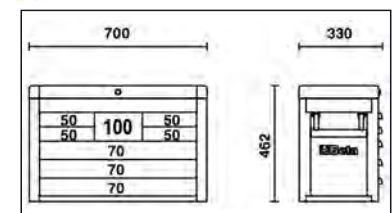
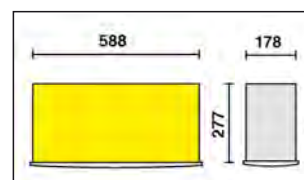

		CHF	📦	📄
RSC23C-O	RAL 2011	835.00	1	023003011
RSC23C-R	RAL 3000	835.00	1	023003013
RSC23C-A	RAL 7016	835.00	1	023003017

RSC23T

coffre à outils portable avec 5 tiroirs

Caractéristiques principales:

- 5 tiroirs (588x367 mm) avec glissières à roulement à billes : 5 tiroirs, 70 mm de haut.
- Serrure centralisée avant.
- Peut être équipé d'un kit de 4 roulettes et 1 poignée (2300ST/KIT)

📦 36 kg



		CHF	📦	📄
RSC23T-FO	RAL 2011	931.00	1	023003020
RSC23T-O	RAL 2011	931.00	1	023003021
RSC23T-G	RAL 9006	931.00	1	023003022
RSC23T-R	RAL 3000	931.00	1	023003023
RSC23T-B	RAL 5015	931.00	1	023003026
RSC23T-A	RAL 7016	931.00	1	023003027
RSC23T-N	RAL 9005	931.00	1	023003029

2300ST/KIT

Kit de 4 roues et poignée pour coffre C23ST

- 4 roues , Ø 125 mm:
2 fixes et 2 mobiles (dont une équipée d'un frein).
- Manche télescopique

📦 6,5 kg

	CHF	📦	📄
2300ST/KIT	251.00	1	023000950



Beta

SERVANTE MOBILE RSC24

Beta
RSC24



NOUVEAU PLAN DE TRAVAIL

**PLUS ROBUSTE
PLUS PRATIQUE
PLUS FONCTIONNEL
PLUS MODERNE**





- Tiroirs montés sur glissières à roulement à billes de précision
- Intérieur des tiroirs protégés par un tapis en caoutchouc mousse
- Possibilité d'insérer jusqu'à 4 plateaux en mousse EVA ou Thermoformés
- Nouveau plan de travail en thermoplastique renforcé, conçu pour supporter les coffres à outils RSC22, RSC23, RSC23C et RSC23T
- Plan de travail multifonction avec bords anti-chute équipé de huit emplacements pour le rangement vertical des tournevis
- Serrure de sécurité centralisé frontale
- Equipée de quatre roulettes Ø 125 mm : 2 fixes et 2 mobiles (dont une équipée d'un frein)
- Capacité de charge statique : 800 kg

Modèles disponibles :

- RSC24/5 (5 tiroirs)
- RSC24/6 (6 tiroirs)
- RSC24/7 (7 tiroirs)
- RSC24/8 (8 tiroirs)

Couleurs disponibles :

RSC24-		h 
FO	RAL 2011	RAL 2011
O	RAL 7016	RAL 2011
G	RAL 7016	RAL 9006
R	RAL 7016	RAL 3000
B	RAL 7016	RAL 5015
A	RAL 7016	RAL 7016
N	RAL 9005	RAL 9005

Accessoires disponibles :



2400 RSC24/PF



2400 RSC24/SPC



2400 RSC24/PL



2400 RSC24/PF-A
2400 RSC24/PF-N



2400 RSC24/PD-A
2400 RSC24/PD-N



5000MS



2400 RSC24/PC-A
2400 RSC24/PC-N

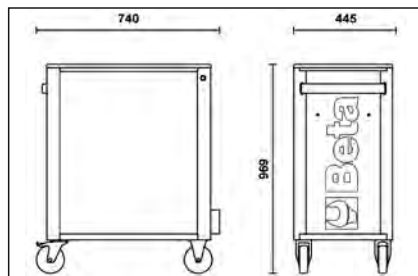
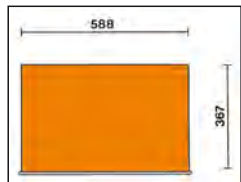

RSC24/7

servante mobile à 7 tiroirs RSC24/7

Caractéristiques principales:

- 7 tiroirs entièrement amovibles (588x367 mm), avec glissières à roulement à billes:
- 5 tiroirs, hauteur 70 mm
- 1 tiroir hauteur 140 mm
- 1 tiroir hauteur 210 mm



63 kg

	CHF		
RSC24/7-FO	1,300.00	1	024004070
RSC24/7-O	1,300.00	1	024004071
RSC24/7-G	1,300.00	1	024004072
RSC24/7-R	1,300.00	1	024004073
RSC24/7-B	1,300.00	1	024004076
RSC24/7-A	1,300.00	1	024004077
RSC24/7-N	1,300.00	1	024004079



Beta
RSC24



h 	 max
70 mm	25 kg
140 mm	30 kg
210 mm	30 kg



RSC24/5

servante mobile avec 5 tiroirs RSC24/5

Caractéristiques principales:

- 5 tiroirs entièrement amovibles (588x367 mm), avec glissières à roulement à billes:
- 2 tiroirs, hauteur 70 mm
- 2 tiroirs hauteur 140 mm
- 1 tiroir, hauteur 280 mm

60 kg

	CHF		
RSC24/5-FO	1,121.00	1	024004050
RSC24/5-O	1,121.00	1	024004051
RSC24/5-G	1,121.00	1	024004052
RSC24/5-R	1,121.00	1	024004053
RSC24/5-B	1,121.00	1	024004056
RSC24/5-A	1,121.00	1	024004057
RSC24/5-N	1,121.00	1	024004059



RSC24/5-O

Beta RSC24



h	max
70 mm	25 kg
140 mm	30 kg
280 mm	35 kg



RSC24/6

servante mobile à 6 tiroirs RSC24/6

Caractéristiques principales:

- 6 tiroirs entièrement amovibles (588x367 mm), avec glissières à roulement à billes:
- 4 tiroirs, hauteur 70 mm
- 1 tiroir hauteur 140 mm
- 1 tiroir, hauteur 280 mm

62 kg

	CHF		
RSC24/6-FO	1,205.00	1	024004060
RSC24/6-O	1,205.00	1	024004061
RSC24/6-G	1,205.00	1	024004062
RSC24/6-R	1,205.00	1	024004063
RSC24/6-B	1,205.00	1	024004066
RSC24/6-A	1,205.00	1	024004067
RSC24/6-N	1,205.00	1	024004069



RSC24/6-O

Beta RSC24



h	max
70 mm	25 kg
140 mm	30 kg
280 mm	35 kg



RSC24/8

servante mobile avec 8 tiroirs RSC24/8

Caractéristiques principales:

- 8 tiroirs entièrement amovibles (588x367 mm), avec glissières à roulement à billes:
- 6 tiroirs, hauteur 70 mm
- 2 tiroirs hauteur 140 mm

66 kg

	CHF		
RSC24/8-FO	1,400.00	1	024004080
RSC24/8-O	1,400.00	1	024004081
RSC24/8-G	1,400.00	1	024004082
RSC24/8-R	1,400.00	1	024004083
RSC24/8-B	1,400.00	1	024004086
RSC24/8-A	1,400.00	1	024004087
RSC24/8-N	1,400.00	1	024004089



RSC24/8-O

Beta RSC24



h	max
70 mm	25 kg
140 mm	30 kg

RSC24A/6

servante mobile avec 6 tiroirs, avec système anti-basculement

Caractéristiques principales:

- 6 tiroirs entièrement amovibles (588x367 mm), avec glissières à roulement à billes : 4 tiroirs, 70 mm de haut 1 tiroir, 140 mm de haut 1 tiroir, 280 mm de haut

800 kg



RSC24A/6-O

62 kg

	CHF		
RSC24A/6-O	1,340.00	1	024004161
RSC24A/6-R	1,340.00	1	024004163
RSC24A/6-A	1,340.00	1	024004167

Beta RSC24



RSC24A/6-A



RSC24A/6-R



h	max
70 mm	25 kg
140 mm	30 kg
280 mm	35 kg

RSC24A/7

servante mobile avec 7 tiroirs, avec système anti-basculement

Caractéristiques principales:

- 7 tiroirs entièrement amovibles (588x367 mm), avec glissières à roulement à billes : 5 tiroirs, 70 mm de haut 1 tiroir, 140 mm de haut 1 tiroir, 210 mm de haut

800 kg



RSC24A/7-O

63 kg

	CHF		
RSC24A/7-O	1,435.00	1	024004171
RSC24A/7-R	1,435.00	1	024004173
RSC24A/7-A	1,435.00	1	024004177

Beta RSC24



RSC24A/7-A



RSC24A/7-R



h	max
70 mm	25 kg
140 mm	30 kg
210 mm	30 kg

RSC24A/8

servante mobile avec 8 tiroirs, avec système anti-basculement

Caractéristiques principales:

- 8 tiroirs entièrement amovibles (588x367 mm), avec glissières à roulement à billes : 6 tiroirs, 70 mm de haut 2 tiroirs, 140 mm de haut

800 kg



RSC24A/8-O

66 kg

	CHF		
RSC24A/8-O	1,550.00	1	024004181
RSC24A/8-R	1,550.00	1	024004183
RSC24A/8-A	1,550.00	1	024004187

Beta RSC24



RSC24A/8-A



RSC24A/8-R



h	max
70 mm	25 kg
140 mm	30 kg



VERSION LONGUE :
Possibilité d'insérer jusqu'à 6 plateaux en mousse EVA ou Thermoformés

SYSTÈME ANTI-BASCULEMENT : EMPÊCHE L'OUVERTURE DE PLUSIEURS TIROIRS SIMULTANÉMENT



- Tiroirs montés sur glissières à roulement à billes de précision
- Plan de travail renforcé en ABS avec bords anti-chute, huit trous pour accueillir des tournevis et 6 plateaux de bac.
- Tiroir à ouverture complète équipée de palette en nylon robuste, avec porte-étiquette intégré
- Quatre roulettes Ø 125 mm : 2 fixes et 2 mobiles (dont une équipée d'un frein)
- Capacité de charge statique : 1000 kg
- Intérieur des tiroirs protégées par des tapis en caoutchouc mousse
- Porte-fiacon latéral intégré
- Serrure de sécurité centralisée frontale

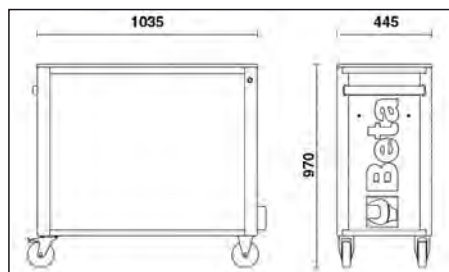

Couleurs disponibles :

O	RAL 7016	RAL 2011
G	RAL 7016	RAL 7016
R	RAL 7016	RAL 3000

Accessoires disponibles :



RSC24AXL/7

servante mobile extra large avec 7 tiroirs, avec système anti-basculement

caractéristiques principales:

- 7 tiroirs entièrement amovibles (882x367 mm), avec glissières à roulement à billes :
- 5 tiroirs, 70 mm de haut
- 1 tiroir, 140 mm de haut
- 1 tiroir, 210 mm de haut



h	max
70 mm	30 kg
140 mm	35 kg
210 mm	35 kg



84 kg

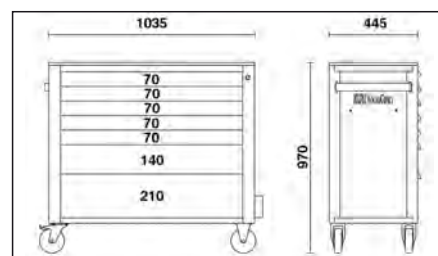
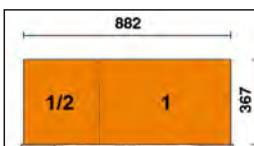

	CHF		
RSC24AXL/7-O	1,820.00	1	024004271
RSC24AXL/7-R	1,820.00	1	024004273
RSC24AXL/7-A	1,820.00	1	024004277

RSC24AXL/8

servante mobile extra large avec 8 tiroirs, avec système anti-basculement

Caractéristiques principales:

- 8 tiroirs entièrement amovibles (882x367 mm), avec glissières à roulement à billes :
- 6 tiroirs, 70 mm de haut.
- 2 tiroirs, 140 mm de haut.

88 kg

	CHF		
RSC24AXL/8-O	1,955.00	1	024004281
RSC24AXL/8-R	1,955.00	1	024004283
RSC24AXL/8-A	1,955.00	1	024004287



h	max
70 mm	30 kg
140 mm	35 kg

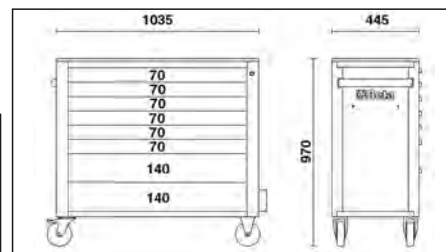
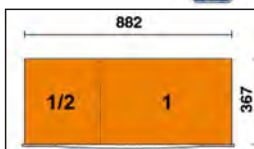

RSC24AXL/9

servante mobile extra large avec 9 tiroirs, avec système anti-basculement

Caractéristiques principales:

- 9 tiroirs entièrement amovibles (882x367 mm), avec glissières à roulement à billes :
- 8 tiroirs, 70 mm de haut
- 1 tiroir, 140 mm de haut.

90 kg

	CHF		
RSC24AXL/9-O	2,075.00	1	024004291
RSC24AXL/9-R	2,075.00	1	024004293
RSC24AXL/9-A	2,075.00	1	024004297



h	max
70 mm	30 kg
140 mm	35 kg

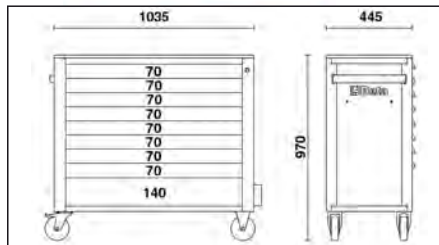
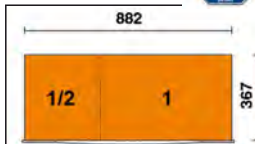

2400 RSC24/PC

support de rouleau de papier pour servante RSC24

0,3 kg

	CHF		
2400 RSC24/PC-A	30.50	1	024004903
2400 RSC24/PC-N	30.50	1	024004904



RAL7016 2400 RSC24/PC-A
RAL9005 2400 RSC24/PC-N



2400 RSC24/PD

porte document pour servante RSC24

1,2 kg

	CHF		
2400 RSC24/PD-A	54.00	1	024004907
2400 RSC24/PD-N	54.00	1	024004908



RAL7016 2400 RSC24/PD-A
RAL9005 2400 RSC24/PD-N



2400 RSC24/PF

panneau porte-outils perforé avec supports, pour servantes RSC24

2,3 kg

	CHF		
2400 RSC24/PF	96.50	1	024004902



2400 RSC24/PF-

porte flacon pour servante RSC24

0,5 kg

	CHF		
2400 RSC24/PF-A	32.00	1	024004905
2400 RSC24/PF-N	32.00	1	024004906

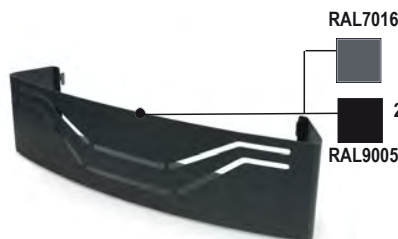

RAL7016 2400S RSC24/PF-A
RAL9005 2400S RSC24/PF-N



2400 RSC24/PL

plan de travail en bois pour servantes RSC24

4,3 kg

	CHF		
2400 RSC24/PL	120.00	1	024004901



2400 RSC24/SPC

support d'ordinateur pour servante mobile RSC24

- Avec tiroir amovible
- Ne peut pas être utilisé avec le modèle RSC24AXL

3,1 kg

	CHF		
2400 RSC24/SPC	175.50	1	024004909



2400 RSC24/MP

Étagère pliable pour RSC24 - RSC24A - RSC51

- Utilisable comme plan de travail supplémentaire
- Plan de travail de 390x440 mm, protégé par un tapis en caoutchouc imperméable à l'huile et à l'essence
- Capacité de charge : 20 kg

📦 3,4 kg



2400 RSC24/MP

CHF 92.50 1 024004900

2499PF

Porte-flacons

- Adaptable sur la C38, C38A

📦 2,5 kg

	CHF		
2499PF-O	90.00	1	024990210
2499PF-G	90.00	1	024990219
2499PF-R	90.00	1	024990230

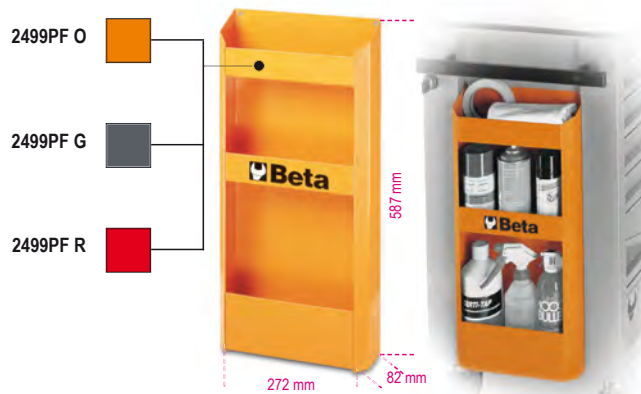

2499PF/M

Porte-flacons universel magnétique

📦 2,2 kg

	CHF		
2499PF/M	81.00	1	024990050



2499PC

support de rouleau de papier

- Possibilité d'être monté sur les servantes C25 et les servantes C38

📦 2,2 kg

	CHF		
2499PC	95.50	1	024990090



RSC24L/7

servante mobile avec 7 tiroirs et étagères latérales

Caractéristiques principales:

- 7 tiroirs (588x367 mm) avec glissières à roulement à billes: 5 tiroirs, 70 mm de haut 1 tiroir, 140 mm de haut 1 tiroir, 210 mm de haut.
- Bases de tiroirs protégées par des tapis en caoutchouc moussé.
- 4 roulettes, E 125 mm : 2 fixes et 2 directions avec freins.
- Serrure centralisée avant.
- Capacité de charge statique : 1 100 kg.
- Plan de travail en bois multicouly avec trous pour un vice (1599F/100, à commander séparément).
- Compartiment latéral avec étagère réglable verticalement.
- Support de rouleau de papier intégré.
- Double porte-bouteille arrière.

80 kg

		CHF		
RSC24L/7-O	RAL 2011	1,970.00	1	024004371
RSC24L/7-R	RAL 3000	1,970.00	1	024004373
RSC24L/7-A	RAL 7016	1,970.00	1	024004377

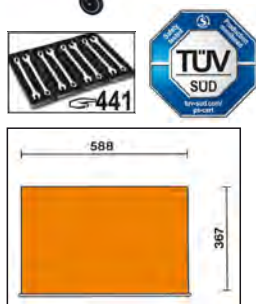

RSC24L-CAB

servante mobile avec 7 tiroirs coffre et étagères latérales

Caractéristiques principales:

- 7 tiroirs (588x367 mm) avec glissières à roulement à billes: 5 tiroirs, 70 mm de haut 1 tiroir, 140 mm de haut 1 tiroir, 210 mm de haut.
- Bases de tiroirs protégées par des tapis en caoutchouc moussé.
- 4 roulettes, E 125 mm : 2 fixes et 2 directions avec freins.
- Serrure centralisée avant.
- Armoire à outils latérale avec porte verrouillable et étagère intérieure réglable verticalement.
- Capacité de charge statique : 1 100 kg.
- Plan de travail en bois multicouly avec trous pour un vice (1599F/100, à commander séparément).
- Support de rouleau de papier intégré.
- Double porte-bouteille arrière.

82 kg

		CHF		
RSC24L-CAB/O	RAL 2011	2,040.00	1	024004471
RSC24L-CAB/R	RAL 3000	2,040.00	1	024004473
RSC24L-CAB/A	RAL 7016	2,040.00	1	024004477

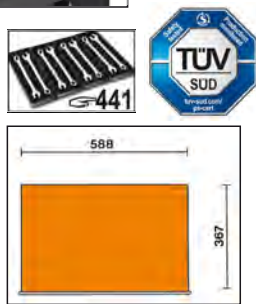

C04TSS-7

Servante mobile d'atelier à 7 tiroirs complètement en acier inoxydable

Caractéristiques principales :

- 7 tiroirs de 570 x 410 mm montés sur glissières à billes de précision ;
- 6 tiroirs - hauteur 83 mm ;
- 1 tiroir - hauteur 170 mm ;
- 4 roues de Ø 125 mm: 2 fixes et 2 pivotantes avec freins ;
- Serrure centralisée centrale ;
- Structure complètement en acier inoxydable ;
- Roues, supports, sphères, intérieur des tiroirs et glissières en acier inoxydable ;
- Poignée tiroirs en aluminium.

📦 63 kg

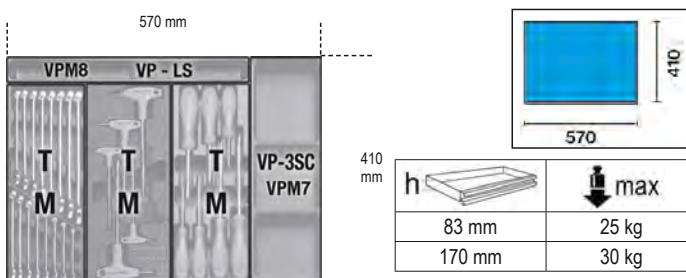

C04TSS/7 CHF 3,370.00 1 024003077 305

C25

Chariot Tank avec étagère

Caractéristiques principales:

- Couvercle de fermeture rabattable.
- 1 tiroir coulissant.
- Plateau de rangement des outils protégé par un tapis en caoutchouc souple.
- Plateaux de service protégés par des tapis en caoutchouc anti-huile et anti-essence.
- Quatre roues ø 100 mm: 2 fixes et 2 pivotantes (une avec frein).
- Serrure de sécurité.
- Plateau thermoformé vide pour douilles et accessoires 1/2" (024990104).
- Possibilité d'application du porte-papier 2499PC.

📦 31,5 kg

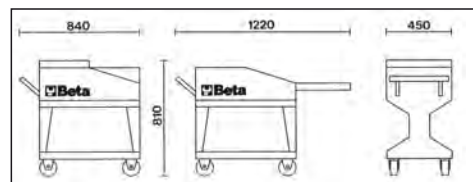

C25 CHF 846.00 1 025000001

C27S

Chariot porte-outils pliable pour interventions en extérieur

Structure en tôle.

Chariot pliable à tubes télescopiques pour faciliter le transport.

2 tiroirs de 588x277 mm, montés sur glissières à billes de précision qui permettent l'ouverture du côté souhaité, à gauche ou à droite.

Vaste compartiment porte-objets inférieur 588x277x220 mm.
2 roues fixes de Ø 160 mm et 2 roues pivotantes de Ø 100 mm
(dont une avec frein)

Plan de travail thermoplastique avec 6 bacs de rangement intégrés.

Serrure de sécurité centralisée.

Prédisposition pour l'emplacement de plateaux thermoformés MC ou pour des séparateurs de tiroirs.

📦 20 kg



C27S-O



C27S-G



C27S-R



h	max
70 mm	20 kg

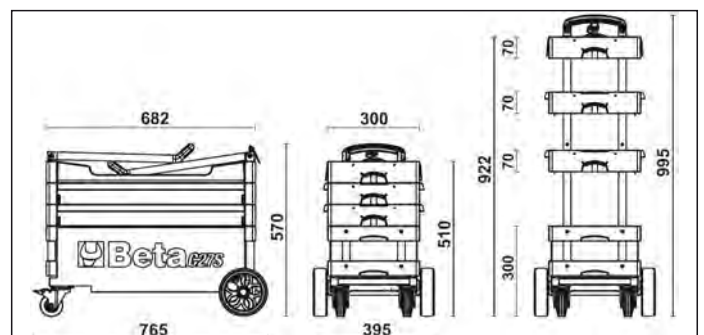
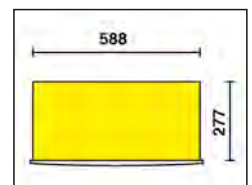

		CHF	📦	🚚
C27S-O	RAL 2011	949.00	1	027000201
C27S-G	RAL 7016	949.00	1	027000202
C27S-R	RAL 3000	949.00	1	027000203

RSC28

Etabli mobile SuperTank avec plan de travail en bois et 10 tiroirs

Caractéristiques principales:

- 10 tiroirs (588x367 mm) avec glissières à roulement à billes.
- Système rapide et sûr pour l'ouverture et la fermeture des tiroirs, avec façade en nylon et fibre de verre.
- 5 tiroirs latéraux : 4 tiroirs, 70 mm de haut 1 tiroir, 210 mm de haut.
- 5 tiroirs avant : 4 tiroirs, 70 mm de haut 1 tiroir, 210 mm de haut.
- Bases de tiroirs protégées par des tapis en caoutchouc moussé.
- 4 roulettes haute capacité, Ø 150 mm : 2 fixes et 2 directions avec freins.
- 2 serrures de sécurité centralisées.
- 3 tiroirs à outils avant.
- Plan de travail en bois multicolory avec trous pour un vice (1599F/150, à commander séparément).
- Compartiment à outils intégré.
- Compartiment latéral avec porte rabattable avec serrure.
- Porte-bouteilles intégrés.
- Compartiment de rangement de 135 mm de haut avec base recouverte de plastique.
- Capacité de charge statique : 1 200 kg.

1200
kg



RSC28-O

130 kg



RSC28-A



RSC28-R



h	max
70 mm	25 kg
210 mm	30 kg

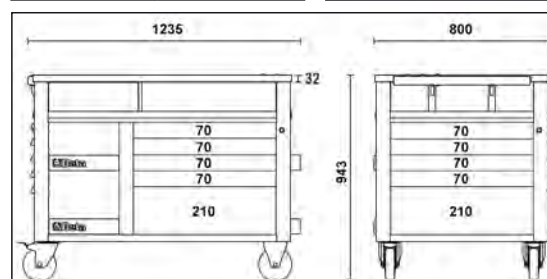
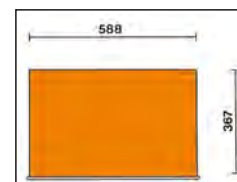

	CHF		
RSC28-O	3,580.00	1	028003001
RSC28-R	3,580.00	1	028003003
RSC28-A	3,580.00	1	028003007

C30M

Établi mobile MaxiTank

Caractéristiques principales:

- 5 tiroirs avant avec glissières à roulement à billes : 3 tiroirs (367x610 mm), 90 mm de haut 1 tiroir (588x610 mm), 90 mm de haut 1 tiroir (588x610 mm), 180 mm de haut.
- Système d'ouverture rapide avec façade en aluminium.
- Bases de tiroirs protégées par des tapis en caoutchouc moussé.
- Peut être équipé de plateaux thermoformés.
- Un vérin hydraulique, conçu pour soulever la partie avant sans effort, permettant ainsi un transport facile.
- 4 roulettes haute capacité : 2 directions, avant, Ø 150 mm 2 fixes, arrière, Ø 170 mm.
- Plan de travail résistant à l'huile et recouvert de caoutchouc, 1300x800 mm, avec trou de vidange pour la collecte des fluides dans un petit réservoir.
- Compartiment de rangement, 720x250x1300 mm, avec plan de travail revêtu de PVC et les panneaux coulissants avant.
- Serrure centralisée pour tiroirs et panneaux.
- 3 porte-bouteilles latéraux intégrés.
- Support de rouleau de papier intégré
- Capacité de charge statique : 1 800 kg.
- Peut accueillir un plan de travail en bois multicouche (3000M/PLM), à commander séparément
- Peut accueillir vice 1599F/150 (à commander séparément).

1800
kg



200 kg

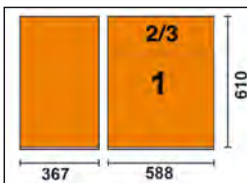

h	max
90 mm	30 kg
180 mm	35 kg

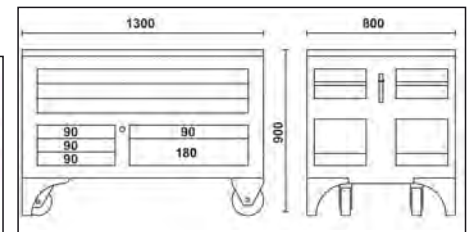

C30M

CHF 5,720.00 1 030000300

3000M/PLM

plan de travail en bois pour C30M, avec trous pour un étau (1599F/150)

10 kg



1240x740x26 mm

3000M/PLM

CHF 575.00 1 030000350



FONCTIONNEL ET ROBUSTE



- Tiroirs coulissants
- Serrure de sécurité centralisé frontale
- Possibilité d'incorporer un plan de travail et des séparateurs de tiroirs (non inclus)
- Capacité de charge statique : 1200 kg

Modèles disponibles :

- **C35/6GM** (6 tiroirs)
- **C35/7GM** (7 tiroirs)
- **C35/8GM** (8 tiroirs)
- **C35/9GM** (9 tiroirs)

Accessoires disponibles :

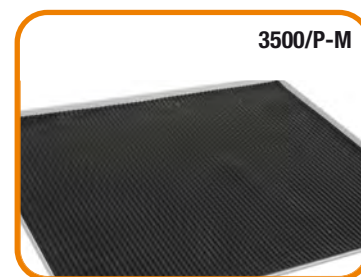

C35/6GM

Coffre fixe industriel avec 6 tiroirs

Caractéristiques principales :

- 6 tiroirs entièrement amovibles (600x447 mm) :
- 2 tiroirs, 75 mm de haut
- 1 tiroir, 100 mm de haut
- 1 tiroir, 150 mm de haut
- 1 tiroir, 200 mm de haut
- 1 tiroir, 300 mm de haut
- Serrure de sécurité centralisée à l'avant.
- Prédiposition pour plan de travail et séparateurs pour tiroirs (à commander séparément)

75 kg



h	↓ max
75 mm	70 kg
100 mm	70 kg
150 mm	70 kg
200 mm	70 kg
300 mm	70 kg

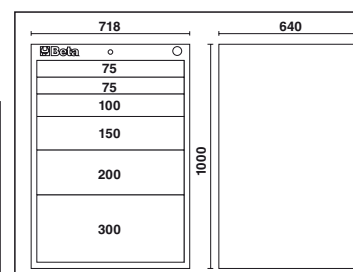
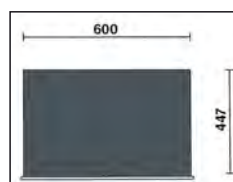

C35/6GM CHF 2,300.00 1 035000162

C35/7GM

Coffre fixe industriel avec 7 tiroirs

Caractéristiques principales :

- 7 tiroirs entièrement amovibles (600x447 mm) :
- 2 tiroirs, 75 mm de haut
- 1 tiroir, 100 mm de haut
- 3 tiroirs, 150 mm de haut
- 1 tiroir, 200 mm de haut
- Serrure de sécurité centralisée à l'avant.
- Prédiposition pour plan de travail et séparateurs pour tiroirs (à commander séparément)

82 kg

C35/7GM

CHF 2,405.00 1 035000172



h	max
75 mm	70 kg
100 mm	70 kg
150 mm	70 kg
200 mm	70 kg

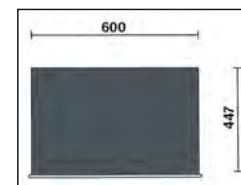

718	640
Beta	
75	
75	
100	
150	
150	
150	
200	

C35/8GM

Coffre fixe industriel avec 8 tiroirs

Caractéristiques principales :

- 8 tiroirs entièrement amovibles (600x447 mm) :
- 4 tiroirs, 75 mm de haut
- 1 tiroir, 100 mm de haut
- 2 tiroirs, 150 mm de haut
- 1 tiroir, 200 mm de haut
- Serrure de sécurité centralisée à l'avant.
- Prédiposition pour plan de travail et séparateurs pour tiroirs (à commander séparément)

86 kg

C35/8GM

CHF 2,560.00 1 035000182



h	max
75 mm	70 kg
100 mm	70 kg
150 mm	70 kg
200 mm	70 kg



718	640
Beta	
75	
75	
75	
100	
150	
150	
200	

C35/9GM

Coffre fixe industriel avec 9 tiroirs

Caractéristiques principales :

- 9 tiroirs entièrement amovibles (600x447 mm) :
- 6 tiroirs, 75 mm de haut
- 3 tiroirs, 150 mm de haut
- Serrure de sécurité centralisée à l'avant.
- Prédiposition pour plan de travail et séparateurs pour tiroirs (à commander séparément)

91 kg

C35/9GM

CHF 2,680.00 1 035000192



h	max
75 mm	70 kg
150 mm	70 kg



718	640
Beta	
75	
75	
75	
75	
75	
75	
150	
150	
150	

3500/P-M

Plan de travail avec rebord périmétral pour coffre C35

3500/P-M

700x600 mm

CHF 448.00 1 035000505

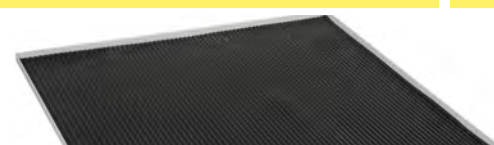

PARE-CHOCS SOUPLE

- Tiroirs montés sur glissières à roulement à billes de précision
- Plan de travail polyvalent robuste
- Tiroir à ouverture complète équipée de palette en aluminium pour une ouverture rapide
- Plan de travail multifonction avec bords anti-chute équipé de d'emplacements pour le rangement des tournevis
- Quatre roulettes Ø 125 mm : 2 fixes et 2 mobiles (dont une équipée d'un frein)
- Capacité de charge statique : 1000 kg
- Pare-chocs angulaires sur toute la hauteur de la servante afin d'éviter d'endommager les véhicules ou la servante à l'intérieur de l'atelier
- Intérieur des tiroirs protégés par un tapis en caoutchouc mousse
- Serrure de sécurité centralisé frontale
- Porte-flacons et support de rouleau papiers intégrés et réglables dans plusieurs positions

Modèles disponibles :

- C37/6 (6 tiroirs)
- C37/7 (7 tiroirs)
- C37/8 (8 tiroirs)
- C37A/7 (7 tiroirs avec système anti-basculement)

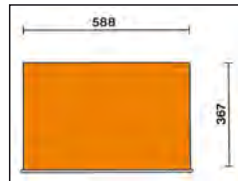

Couleurs disponibles :

O	RAL 2011
G	RAL 7016
R	RAL 3000

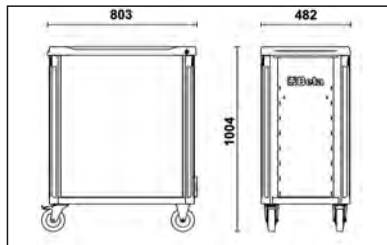

Accessoires disponibles :

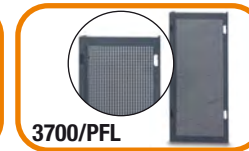

C37/7

Servante mobile d'atelier à 7 tiroirs

Caractéristiques principales :

- 7 tiroirs de 588x367 mm, montés sur glissières à billes de précision :
- 5 tiroirs hauteur 75 mm
- 1 tiroir hauteur 150 mm
- 1 tiroir hauteur 225 mm

71 kg



C37/7-G



C37/7-R



h	max
75 mm	30 kg
150 mm	35 kg
225 mm	35 kg

	CHF		
C37/7-O	1,560.00	1	037000071
C37/7-G	1,560.00	1	037000072
C37/7-R	1,560.00	1	037000073

C37/6

Servante mobile d'atelier
à 6 tiroirs

Caractéristiques principales :

- 6 tiroirs de 588x367 mm, montés sur glissières à billes de précision :
- 4 tiroirs hauteur 75 mm
- 1 tiroir hauteur 150 mm
- 1 tiroir hauteur 305 mm

1000
kg



C37/6-O

69 kg

	CHF		
C37/6-O	1,510.00	1	037000061
C37/6-G	1,510.00	1	037000062
C37/6-R	1,510.00	1	037000063



C37/6-G



C37/6-R



h	max
75 mm	30 kg
150 mm	35 kg
305 mm	40 kg



C37/8

Servante mobile d'atelier
à 8 tiroirs

Caractéristiques principales :

- 8 tiroirs de 588x367 mm, montés sur glissières à billes de précision :
- 6 tiroirs hauteur 75 mm
- 2 tiroirs hauteur 150 mm

1000
kg



C37/8-O

73 kg

	CHF		
C37/8-O	1,625.00	1	037000081
C37/8-G	1,625.00	1	037000082
C37/8-R	1,625.00	1	037000083



C37/8-G



C37/8-R



h	max
75 mm	30 kg



C37A/7

Servante mobile d'atelier
à 7 tiroirs avec système anti-basculement

Caractéristiques principales :

- 7 tiroirs de 588x367 mm, montés sur glissières à billes de précision :
- 5 tiroirs hauteur 75 mm
- 1 tiroir hauteur 150 mm
- 1 tiroir hauteur 225 mm

1000
kg



C37A/7-O

71 kg

	CHF		
C37A/7-O	1,605.00	1	037000271
C37A/7-G	1,605.00	1	037000272
C37A/7-R	1,605.00	1	037000273



C37A/7-G



C37A/7-R



h	max
75 mm	30 kg
150 mm	35 kg
225 mm	35 kg



3700/PLA

Établi en acier inoxydable pour servante C37

📦 2,8 kg

3700/PLA CHF 91.00 1 037000100



3700/PLL

Plan de travail en bois pour chariot C27

Avec possibilité de placer un étau 1599P/100 (à commander séparément)

📦 3,9 kg

3700/PLL CHF 114.00 1 037000101



672x396x28 mm

3700/PF

Panneau perforé avec supports pour servante C37

📦 3,2 kg

3700/PF CHF 90.50 1 037000102

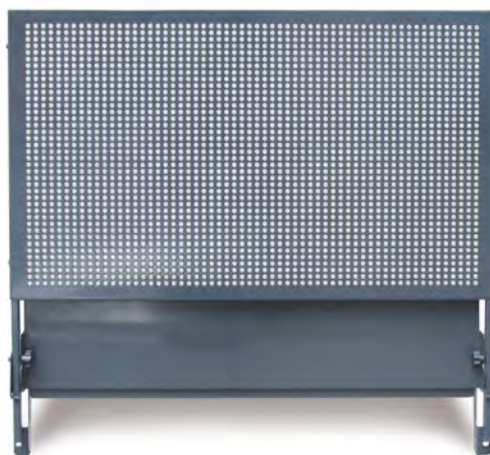

3700/PFL

Panneau perforé latéral pour servante C37

📦 1,9 kg

3700/PFL CHF 48.50 1 037000104



3700/PC

Support porte-ordinateur pour servante C37

📦 3,1 kg

3700/PC CHF 123.50 1 037000103



C38

Servante mobile d'atelier
à onze tiroirs

Caractéristiques principales:

- 11 tiroirs montés sur glissières à billes de précision :
- 1 tiroir 937x410x122 mm
- 3 tiroirs 570x410x74 mm
- 2 tiroirs 570x410x153 mm
- 3 tiroirs 313x410x74 mm
- 2 tiroirs 313x410x153 mm
- Fond des tiroirs protégé par un tapis en néoprène.
- Capacité de charge statique : 1200 kg.
- 4 roues haute capacité : Ø 125 mm, 2 fixes et 2 pivotantes (toutes les deux avec frein à levier).
- Verrouillage de sécurité centralisé frontal.
- Plan de travail en tôle revêtue d'un tapis en caoutchouc.
- Possibilité d'application du porte-papier 2499PC et du porte-flacons 2499PF.

114 kg



C38-G

C38-R

C38-O



h	max
74 mm	25 kg
153 mm	30 kg

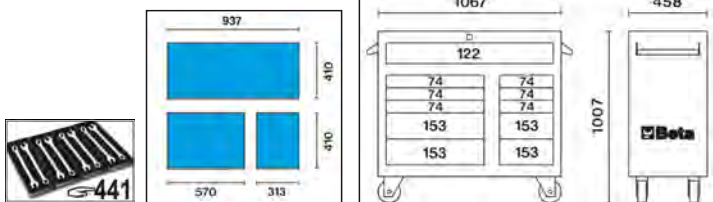

	CHF		
C38-O	2,475.00	1	038000001
C38-G	2,475.00	1	038000003
C38-R	2,475.00	1	038000002

C38L

coffre latéral à 7 tiroirs

Caractéristiques principales :

- 7 tiroirs (410x313 mm), montés sur glissières à billes de précisions :
- 5 tiroirs d'une hauteur de 74 mm 2 tiroirs d'une hauteur de 153 mm
- Fond des tiroirs protégé par un tapis en Néoprène
- Verrouillage de sécurité centralisé frontale
- Plan de travail en Aluminium antidérapant
- Possibilité d'être fixé de chaque côté de la servante C38

45 kg



h	max
74 mm	25 kg
153 mm	30 kg

	CHF		
C38L-O	1,198.00	1	038000081
C38L-G	1,198.00	1	038000083
C38L-R	1,198.00	1	038000082

C38LA

Coffre latéral avec porte et étagère interne

Caractéristiques principales:

- Serrure centralisée frontale
- Étagère interne réglable en hauteur
- Porte documents située à l'intérieur du panneau
- Plan de travail en aluminium antidérapant
- Possibilité d'être fixé de chaque côté de la servante C38

18 kg

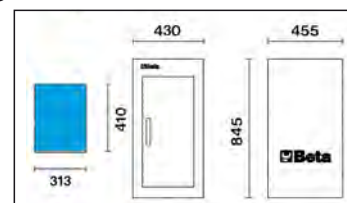

	CHF		
C38LA O	458.00	1	038000071
C38LA G	458.00	1	038000073
C38LA R	458.00	1	038000072

C38C

Servante mobile d'atelier à 25 tiroirs, avec :

- 1 servante mobile C38
- 2 coffres latéraux C38L
- 1 coffre C38T

📦 268 kg



C38C-O



C38C-G



C38C-R



h	max
74 mm	25 kg
153 mm	30 kg

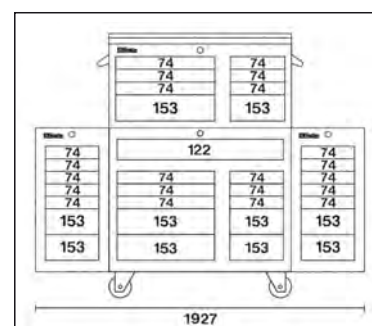
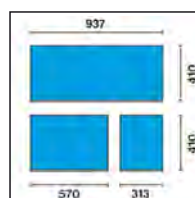

	CHF	📦	📄
C38C-O	6,420.00	1	038000201
C38C-G	6,420.00	1	038000203
C38C-R	6,420.00	1	038000202

C38T

coffre à 8 tiroirs et compartiment porte outils

Caractéristiques principales :

- 8 tiroirs montés sur glissières à billes de précisions :
- 3 tiroirs 570X410X74mm
- 1 tiroir 570X410X153mm
- 3 tiroirs 313x410x74mm
- 1 tiroir 313x410x153mm

Compartiment porte-outils assisté de 2 verins • Fond des tiroirs protégé par un tapis en Néoprène

- Verrouillage de sécurité centralisé frontale
- Plan de travail en Aluminium antidérapant
- Possibilité d'être posé sur la servante C38

📦 64 kg



C38T-O



C38T-G



C38T-R

h	max
74 mm	25 kg
153 mm	30 kg

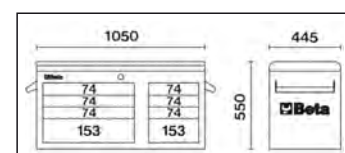
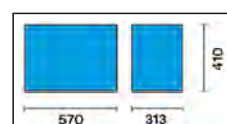

	CHF	📦	📄
C38T-O	1,555.00	1	038000091
C38T-G	1,555.00	1	038000093
C38T-R	1,555.00	1	038000092

SERVANTE C39

MONTANTS ET PALETTES DES TIROIRS EN ALLIAGE D'ALUMINIUM + ROBUSTE ET + LÉGÈRE

- Tiroirs montés sur glissières à roulement à billes de précision
- Plan de travail multifonction thermoplastique, conçu pour supporter le coffre à outils portable C39T
- Système de palette en aluminium, pour une ouverture rapide du tiroir et s'ouvrant sur toute la longueur.
- Quatre roulettes Ø 125 mm : 2 fixes et 2 mobiles (dont une d'un frein)
- Capacité de charge statique : 1200 kg
- Intérieur des tiroirs protégés par un tapis en caoutchouc mousse
- Serrure de sécurité centralisé frontale
- Compartiments de rangement et emplacement pour tournevis
- Porte-flacon latéraux et arrière intégrés
- Support de rouleau de papier intégré

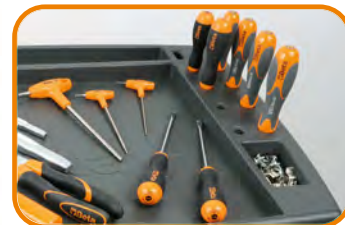

Modèles disponibles :

- C39/6 (6 tiroirs)
- C39/7 (7 tiroirs)
- C39/8 (8 tiroirs)

Couleurs disponibles :

	
O	RAL 2011
G	RAL 7016
R	RAL 3000

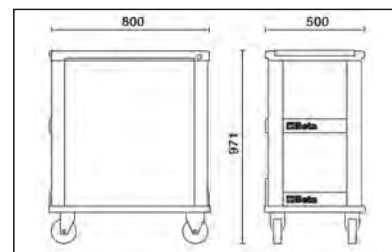
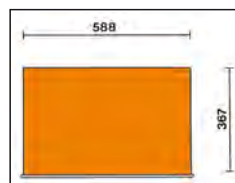

C39/7

Servante mobile à sept tiroirs

Caractéristiques principales:

- Sept tiroirs de 588x367 mm, montés sur glissières à billes de précision:
- 5 tiroirs hauteur 70 mm
- 1 tiroir hauteur 140 mm
- 1 tiroir hauteur 210 mm.

61 kg

1200 kg



C39-7/G



C39-7/R

C39-7/O

h	max
70 mm	30 kg
140 mm	35 kg
210 mm	35 kg



	CHF		
C39-7/O	2,355.00	1	039000001
C39-7/G	2,355.00	1	039000002
C39-7/R	2,355.00	1	039000003

C39/6

Servante mobile d'atelier

Caractéristiques principales :

- 6 tiroirs de 588x367 mm, montés sur glissières à billes de précision :
- 4 tiroirs hauteur 70 mm
- 1 tiroir hauteur 140 mm
- 1 tiroir hauteur 280 mm

📦 59 kg

	CHF	📦	💻
C39-6/O	2,230.00	1	039000031
C39-6/G	2,230.00	1	039000032
C39-6/R	2,230.00	1	039000033



C39-6/G



C39-6/R



h	max
70 mm	30 kg
140 mm	35 kg
280 mm	40 kg



C39/8

Servante mobile d'atelier à huit tiroirs

Caractéristiques principales :

- 8 tiroirs de 588x367 mm, montés sur glissières à billes de précision :
- 6 tiroirs hauteur 70 mm
- 2 tiroirs hauteur 140 mm

📦 64 kg

	CHF	📦	💻
C39-8/O	2,520.00	1	039000041
C39-8/G	2,520.00	1	039000042
C39-8/R	2,520.00	1	039000043



C39-8/G



C39-8/R



h	max
70 mm	30 kg



C39T

Coffre à quatre tiroirs

Caractéristiques principales :

- 4 tiroirs (588x367 mm), montés sur glissières à billes de précision :
- 4 tiroirs hauteur 70 mm
- Serrure centralisée frontale.
- Montants et façade du tiroir en aluminium.

📦 29 kg

	CHF	📦	💻
C39T-O	1,510.00	1	039000101
C39T-G	1,510.00	1	039000102
C39T-R	1,510.00	1	039000103



C39T-O



C39T-R



C39T-G



📦 29 kg

h	max
70 mm	30 kg

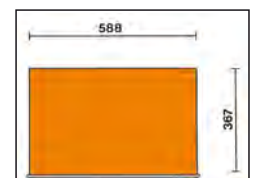
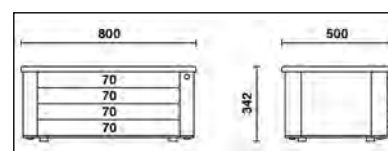

2400-COVER RSC24

housse en nylon pour servante RSC24, RSC24A, C39

2400-COVER RSC24

CHF 30.50 1 024000910



2400-COVER RSC24AXL

housse en nylon pour servante RSC24A-XL, RSC24L, RSC24L-CAB

2400-COVER RSC24AXL

CHF 42.00 1 024000930



3700-COVER C37

Housse de protection en nylon pour servante C37

3700-COVER C37

CHF 40.50 1 037000930

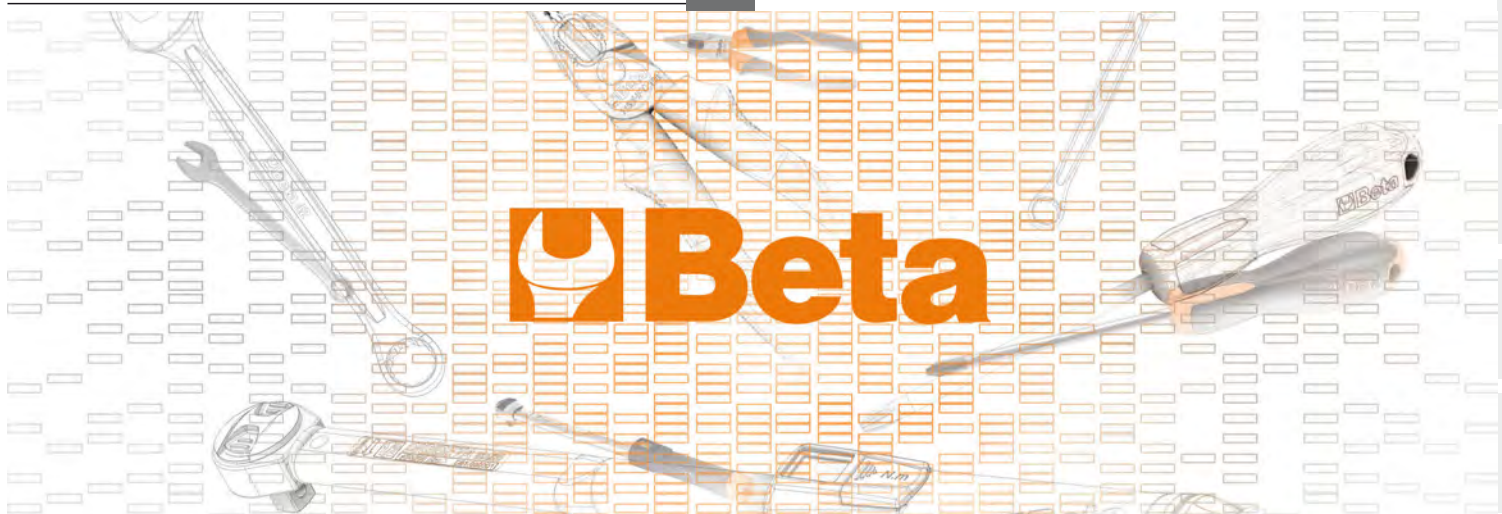

C39SM

Servante spéciale mobile type Racing SM

Caractéristiques techniques

- Plan de travail en bois contre-plaqué stratifié
- 4 roues Ø 125 mm
- 2 fixes et 2 pivotantes (une avec frein) avec plinthes rabattables cache-roues
- Capacité de charge statique : 1200 kg

Module avec 7 tiroirs

de 588x367 mm, montés

sur glissières à billes de précision :

6 tiroirs hauteur 70 mm

1 tiroir hauteur 240 mm

- Fonds des tiroirs protégés par un tapis en Néoprene.
- Serrure de sécurité centralisée frontale.
- Système d'ouverture positionné sur toute la longueur du tiroir.
- Façade des tiroirs en aluminium.

Module de service

- Poubelle incorporée
- Compartiment pour rouleau de papier
- 1 soute porte-objets 420x305x270 mm

125 kg

		CHF		
C39SM-O	RAL 2011	3,830.00	1	039390001
C39SM-G	RAL 7016	3,830.00	1	039390002
C39SM-R	RAL 3000	3,830.00	1	039390003



h	max
70 mm	30 kg
240 mm	40 kg

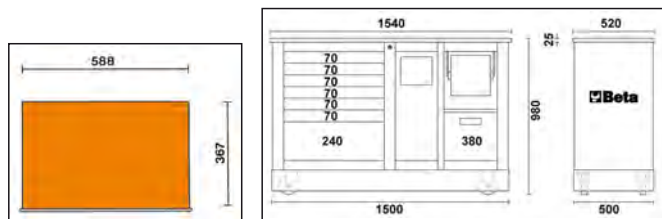

C39MD

Servante spéciale mobile type Racing MD

Caractéristiques techniques

- Plan de travail en bois contre-plaqué stratifié
- 4 roues Ø 125 mm
- 2 fixes et 2 pivotantes (une avec frein) avec plinthes rabattables cache-roues
- Capacité de charge statique : 1200 kg

Module avec 7 tiroirs

de 588x367 mm, montés

sur glissières à billes de précision :

6 tiroirs hauteur 70 mm

1 tiroir hauteur 240 mm

- Fonds des tiroirs protégés par un tapis en Néoprene.
- Serrure de sécurité centralisée frontale.
- Système d'ouverture positionné sur toute la longueur des tiroirs.
- Façade des tiroirs en aluminium.

Module avec 2 tiroirs

de 588x367x270 mm et 588x367x380 mm, montés sur glissières à billes de précision

- Fonds des tiroirs protégés par un tapis en Néoprene
- Serrure de sécurité centralisée frontale
- Système d'ouverture positionné sur toute la longueur des tiroirs
- Façade des tiroirs en aluminium.

123 kg

		CHF		
C39MD-O	RAL 2011	3,940.00	1	039390101
C39MD-G	RAL 7016	3,940.00	1	039390102
C39MD-R	RAL 3000	3,940.00	1	039390103

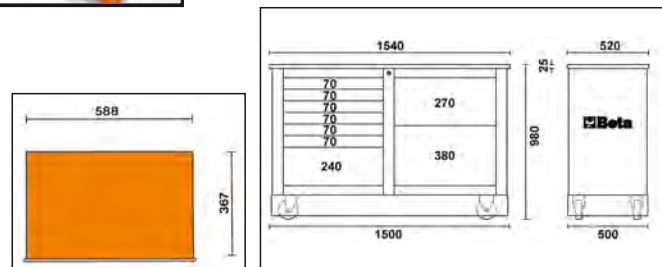

C41S

Chariot porte-outils
à deux modules superposables

Caractéristiques principales:

- Structure en tôle d'acier et volet de fermeture en matière plastique: très robuste et léger.
- 2 modules séparables:
1 coffre supérieur,
1 module avec 1 tiroir de 95 mm de haut et 1 tiroir de 295 mm de haut.
- Roues de grand diamètre (160 mm), incorporées dans la structure pour faciliter le déplacement également dans les escaliers.
- Serrure centralisée latérale pour la fermeture des 2 tiroirs du module inférieur.
- Tiroirs montés sur glissières télescopiques avec roulement à billes et double crochet de fermeture.
- Poignée télescopique en aluminium.
- Plateau de rangement incorporé dans le coffre supérieur.
- Tiroir du bas avec double glissière de précision

Assortiments préconisés: 5940/SBK et 5915VU/5

16 kg

C41S CHF 650.00 1 041000001

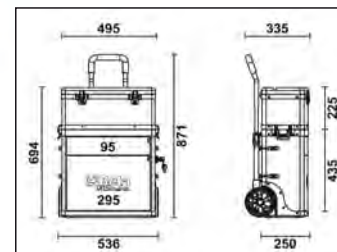
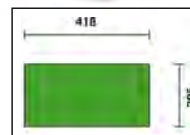

C41H

Chariot porte-outils à deux modules superposables

Caractéristiques principales:

- Structure en tôle d'acier et volet de fermeture en matière plastique: très robuste et léger.
- 2 modules séparables:
1 coffre supérieur,
1 module avec 2 tiroirs de 95 mm de haut, 1 tiroir amovible en matière plastique de 66 mm de haut et 1 tiroir de 295 mm de haut.
- Roues de grand diamètre (160 mm), incorporées dans la structure pour faciliter le déplacement également dans les escaliers.
- Serrure centralisée latérale pour la fermeture des tiroirs du module inférieur.
- Tiroirs montés sur glissières télescopiques avec roulement à billes et double crochet de fermeture.
- Poignée télescopique en aluminium.
- Plateau de rangement incorporé dans le coffre supérieur.
- Tiroir du bas avec double glissière de précision

Assortiments préconisés: 5941VU/M, 5940/SBK et 5915VU/5

* Couleurs disponibles sur demande

21 kg

		CHF		
C41H-O	RAL 2011	734.00	1	041000002
C41H-N	RAL 9005	734.00	1	041000005
C41H-B	RAL 5002	734.00	1	041000006
C41H-R	RAL 3000	734.00	1	041000008
C41H-G	RAL 7016	734.00	1	041000010
C41H-Y	RAL 1023	734.00	1	041000012
C41H-W	RAL 9016	734.00	1	041000021
C41H-V	RAL 6016	734.00	1	041000024



C41H-O



C41H-W

C41H-Y

C41H-R

C41H-V

C41H-B

C41H-G

C41H-N

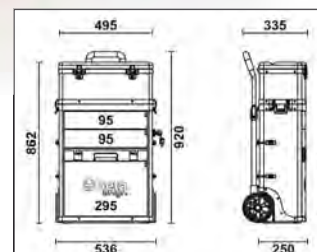
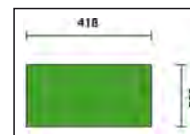

C41H/CE

Coffret porte-outils avec séparateurs amovibles pour accessoires,
en matière plastique

1,3 kg

C41H/CE CHF 46.00 1 041000916



C42H

Chariot porte-outils à 3 modules superposables

Caractéristiques principales :

- Structure en tôle d'acier et volet de fermeture en matière plastique : très robuste et léger.
- 3 modules séparables :
 - 1 coffre supérieur, hauteur 220 mm
 - 1 module porte-outils central, hauteur 180 mm
 - 1 module porte-outils inférieur avec roues, hauteur 330 mm.
- Roues de gros diamètre (ø 160 mm).
- Poignée télescopique réglable en 3 positions
- Système de décrochage rapide des modules : accès rapide et facile aux différents compartiments porte-outils.
- Panier supérieur avec compartiment porte-objets interne et 3 porte-outils incorporés dans le couvercle.
- Prévu pour être utilisé seulement avec 2 modules.

Assortiments préconisés: 5940/SBK et 5915VU/5

14 kg

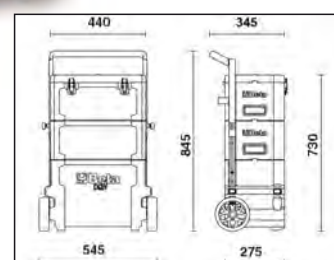

C42H

CHF 522.00 1 042000002

 **Beta**

CX49-G

Chariot multifonction

Utilisable comme poste de travail mobile pour instruments de diagnostic, ordinateurs portables, testeurs et chargeurs de batterie.

CARACTÉRISTIQUES

- Structure en tôle vernie : stabilité et solidité maximum
- Poignée ergonomique
- Plan d'appui supérieur sur 2 niveaux
- Tiroir extractible pour mini clavier
- 2 rayons centraux avec position réglable et 1 rayon bas fixe
- 4 enrouleurs pratiques latéraux en plastique
- 2 pratiques bacs de rangement latéraux
- 2 roues arrière fixes Ø 160 mm
- 2 roues avant pivotantes Ø 100 mm (dont une avec frein)
- Poids : 36 kg

CX49

CHF 968.00 1 049000102

1099 mm
460 mm
435 mm



CA49-G

Chariot multifonction avec porte

Utilisable comme poste de travail mobile pour instruments de diagnostic, ordinateurs portables, testeurs et chargeurs de batterie.

CARACTÉRISTIQUES

- Structure en tôle vernie : stabilité et solidité maximum
- Manche ergonomique
- Plan d'appui supérieur sur 2 niveaux
- Tiroir extractible pour mini clavier
- 1 rayon avec position réglable, 1 rayon fixe et porte de fermeture
- 4 pratiques enrouleurs de câbles latéraux en plastique
- 2 pratiques conteneurs latéraux
- 2 roues arrière fixes Ø 160 mm
- 2 roues avant pivotantes Ø 100 mm (une avec frein)
- Poids : 36,5 kg

CA49 G

CHF 1,087.00 1 049000112



1099 mm
460 mm
435 mm

4900-COVER C49

Housse de protection en nylon pour chariot multifonction C49

4900-COVER C49

CHF 46.00 1 049000930



C48M

Chariot à plate-forme électrique, avec barrières sur les 4 cotés.

Les dimensions compactes et une utilisation polyvalente font du chariot plateforme C48M la solution idéale pour la manutention de charges lourdes (caisses, conteneurs, objets encombrants, pièces d'équipement) en mode assisté en toute sécurité, y compris dans des zones difficilement accessibles et dans des environnements de travail qui ne sont pas accessibles par des chariots élévateurs.

Cela se traduit par une réduction significative des risques pour les opérateurs - par ex. troubles musculo-squelettiques causés par la manipulation manuelle de charges.

Plateforme motorisée, avec moteur 24V - 400W et alimentation 2x12V - 33Ah et carte de contrôle Curtis.

Plateforme de chargement en acier robuste, recouvert de caoutchouc antidérapant, avec panneaux tubulaires ronds empêchant les objets de tomber pendant le transport.

Les panneaux peuvent être retirés pour répondre aux besoins de transport individuels.

La console de commande est équipée des éléments suivants:

- la clé de contact
- bouton de réglage de la vitesse
- poignées papillon latérales pour le contrôle de la traction
- bip intermittent, qui est activé lors du déplacement en marche arrière
- indicateur de charge de la batterie
- bouton de coupure du frein électrique
- bouton d'arrêt d'urgence.

Equippé de 2 roues de traction pneumatiques (Ø 260 mm) et de 2 roues pivotantes en caoutchouc (Ø 150 mm), frein électromagnétique et différentiel.

Livré avec un chargeur de batterie externe, 220V / 50Hz - V / A 24/12

SPÉCIFICATIONS FONCTIONNELLES

Capacité de charge: 400 kg

Vitesse de conduite: 4-6 km / h (réglable)

Autonomie de la batterie: 4 heures

Pente maximale autorisée à pleine charge: 6%

Pente maximale autorisée avec une charge de 100 kg: 18%

Dispositifs de sécurité:

Frein électronique

Avertisseur sonore

Protection anti-écrasement

Indicateur de charge de la batterie

Chariot de contrôle Curtis

SPÉCIFICATIONS TECHNIQUES

Dimensions hors tout: 1280x630x1100h mm

Dimensions utiles de la plate-forme de chargement avec panneaux: 1180x580 mm

Dimensions utiles de la plate-forme de chargement sans panneaux: 1260x620 mm

Hauteur de la plate-forme de chargement à partir du sol: 320 mm

Hauteur du compartiment à piles par rapport au sol: 65 mm

Poids avec batteries: 140 kg

📦 140 kg

C48M CHF 3,530.00 1 048000230

Beta
BRUTUS

CE

400
kg



1100
630
1280



C48P

Chariot pliable

Caractéristiques principales :

- Plateforme de chargement en polypropylène (PP) renforcé, revêtement antiglisse et inserts en TPV pour couvrir les saillies
- Poignée pliable pour un stockage rapide et peu encombrant
- 4 roues anti-traces Ø 125 mm : 2 fixes et 2 pivotantes avec freins
- Capacité maximum : 300 kg.
- Largeur utile de la plateforme de chargement : 705 mm
- Profondeur de la plateforme de chargement : 480 mm
- Hauteur de la plateforme de chargement : 200 mm



300
kg



📦 11 kg

C48P CHF 332.00 1 048000030

C51

Chariot d'atelier métallique

- 3 plateaux revêtus de caoutchouc antidérapant
- Poignée ergonomique
- Double possibilité de fixation du plateau central
- 4 roues Ø 100 mm: 2 fixes et 2 pivotantes (dont une avec frein)
- Capacité de charge statique : 200 kg. (réparties sur les 3 étagères)

21 kg

		CHF		
C51 O	RAL 2011	370.00	1	051000001
C51 G	RAL 7016	370.00	1	051000002
C51 R	RAL 3000	370.00	1	051000003

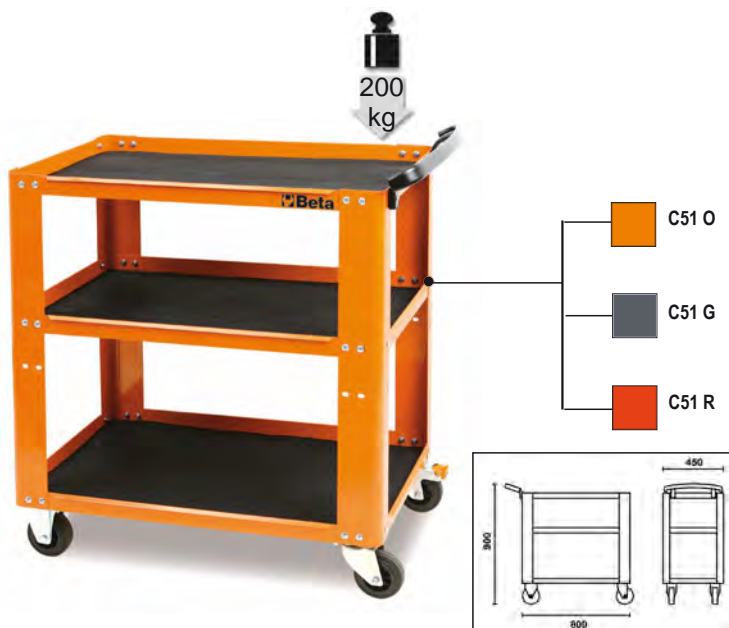

RSC51

Chariot de service d'atelier à 3 tiroirs

Caractéristiques principales :

- Plan de travail renforcé en ABS, solide et robuste
- Plateau polyvalent avec bords antichute et 8 trous pour accueillir les tournevis
- 3 tiroirs (588x367 mm) avec glissières à roulement à billes, 70 mm de haut
- Bases de tiroirs protégées par des tapis en caoutchouc moussé
- Chaque tiroir peut accueillir jusqu'à 4 plateaux thermoformés en mousse EVA ou ABS
- Serrure de sécurité centralisée à l'avant
- Pratique porte-tournevis latéral inclus
- Deux porte-spray aérosol latéraux intégrés dans la structure
- Grande étagère inférieure protégée par un tapis en caoutchouc imperméable à l'huile et à l'essence
- Quatre roulettes, Ø 125 mm: 2 fixes et 2 directions (une avec frein)

- Capacité de charge statique : 400 kg
- Portée de chaque tiroir : 15 kg distribués de manière uniforme

Les accessoires suivantes peuvent être ajoutés :

- Plan de travail en bois 2400 RSC24/PL
- Panneau d'outils perforé 2400 RSC24/PF
- Support d'ordinateur 2400 RSC24/SPC
- Étagère pliante 2400 RSC24/MP
- Porte-rouleau de papier 2400 RSC24/PC-A

38 kg

		CHF		
RSC51-FO	RAL 2011	738.00	1	051000300
RSC51-R	RAL 3000	738.00	1	051000303
RSC51-A	RAL 7016	738.00	1	051000307



2400 RSC24/MP

Étagère pliante pour RSC24 - RSC24A - RSC51

- Utilisable comme plan de travail supplémentaire
- Plan de travail de 390x440 mm, protégé par un tapis en caoutchouc imperméable à l'huile et à l'essence
- Capacité de charge : 20 kg

3,4 kg

		CHF		
2400 RSC24/MP		92.50	1	024004900

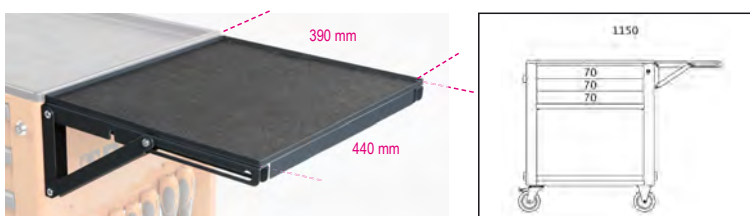

CP51

Chariot charges lourdes

- 2 étagères recouvertes de tapis en caoutchouc
- Poignée ergonomique
- Quatre roues Ø 125 mm à haute résistance :
2 fixes et 2 pivotantes avec frein
- Capacité de charge statique : 750 kg (distribuée sur 2 étagères)

📦 37 kg

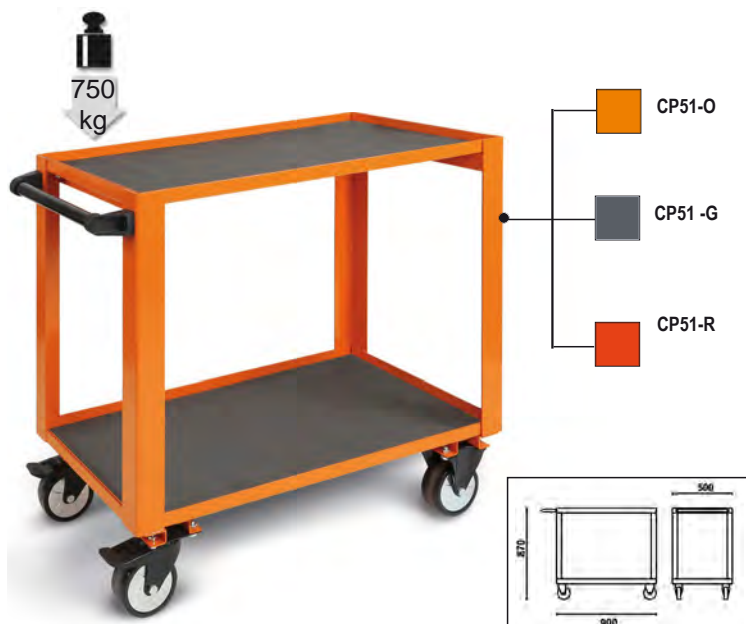

		CHF	📦	🖨️
CP51 O	RAL 2011	489.00	1	051000501
CP51 G	RAL 7016	489.00	1	051000502
CP51 R	RAL 3000	489.00	1	051000503

CB52

Chariot pour la maintenance des boîtes de vitesses et transmissions avec récupérateur d'huile

Le plan incliné et les trous d'écoulement permettent la récupération des liquides directement dans la cuve de collecte

Doté de :

- 4 roues pivotantes dont 2 avec frein
- grand tiroir de rangement avec séparateur
- cuve de collecte liquides extractible avec capacité 7 litres

Dimensions : 1200x640x870 mm

Poids : 60 kg

📦 60 kg



		CHF	📦	🖨️
CB52		934.00	1	052000201

Beta

C56P O

Établi pliable

Compact et facile à transporter.
Plan de travail de 800x500mm (épaisseur 30 mm) en MDF et tôle galvanisée, utilisable des deux côtés.
Poignée avec protection en caoutchouc pour un transport aisé.
Pieds avec couverture antidérapante.
Capacité de charge statique : 250 kg

📦 25 kg

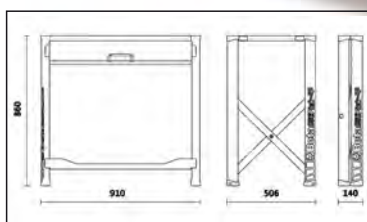

C56P O

CHF 541.00 1 056000011

C56PL O

Établi pliable, version légère

Léger, compact et facile à transporter.
Plan de travail de 800x500 mm en tôle galvanisée utilisable d'un seul côté, protégé par un revêtement en caoutchouc de protection contre l'huile et l'essence.
Poignée avec protection en caoutchouc pour un transport aisé.
Pieds avec revêtement antiglisse.
Capacité de charge statique : 200 kg

📦 18,5 kg

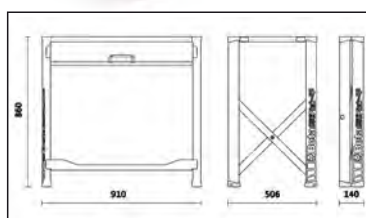

C56PL O

CHF 467.00 1 056000021

C54S

Armoires Cargo

Ce modèle a été conçu après de longues recherches auprès des utilisateurs professionnels. Il offre la solution idéale pour un travail rationnel. Deux panneaux perforés fixés sur les portes peuvent s'ouvrir et augmenter la capacité de rangement.

Caractéristiques principales:

- 1 tiroir grande capacité monté sur glissières télescopiques.
- Possibilité de modifier la disposition intérieure des outils à fin de répondre aux exigences les plus spécifiques.
- Fixation murale simplifiée en utilisant les 2 emplacements situés derrière l'armoire.
- Verrouillage de sécurité centralisé pour les portes et le tiroir.
- Plateau thermoformé vide pour douilles et accessoires 1/2".



C54S-G



C54S-R



C54S-O

37 kg



519

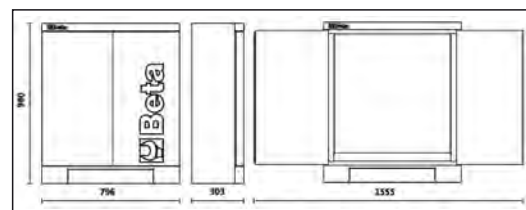

		CHF		
C54S-O	RAL 2011	932.00	1	054000301
C54S-G	RAL 7016	932.00	1	054000302
C54S-R	RAL 3000	932.00	1	054000303

Beta

C57SA

Établi MasterCargo

- Modèle avec paroi porte-outils (C57P) et un bloc à tiroirs.

Bloc à tiroirs composé de 5 tiroirs de 588x367 mm dont 3 de 90 mm de haut, 1 de 180 mm de haut et 1 de 280 mm, montés sur glissières à billes de précision. Prévu pour l'insertion de plateaux thermoformés. Serrure centralisée.

Paroi porte-outils avec 2 trous à l'arrière pour la fixation au mur. Volet roulant en aluminium à mouvement vertical avec serrure de sécurité. Trois panneaux perforés amovibles pour le support des outils.

Plan de travail en bois contre-plaqué stratifié, avec revêtement en laminé plastique, avec 3 trous pour l'installation d'un étau 1599F/150 (en option).

📦 205 kg



C57SA-O



C57SA-G



C57SA-R



h	max
90 mm	30 kg
180 mm	40 kg
280 mm	40 kg

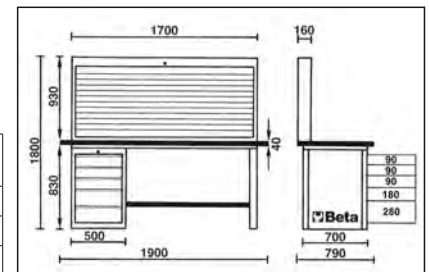

		CHF	📦	🚚
C57SA-O	RAL 2011	5,950.00	1	057001005
C57SA-G	RAL 7016	5,950.00	1	057001205
C57SA-R	RAL 3000	5,950.00	1	057001405

C57SD

Établi MasterCargo

- Modèle avec un bloc à tiroirs

Bloc à tiroirs composé de 5 tiroirs de 588x367 mm dont 3 de 90 mm de haut, 1 de 180 mm de haut et 1 de 280 mm, montés sur glissières à billes de précision. Prévu pour l'insertion de plateaux thermoformés. Serrure centralisée.

Plan de travail en bois contre-plaqué stratifié, avec revêtement en laminé plastique, avec 3 trous pour l'installation d'un étau 1599F/150 (en option)

📦 158 kg



C57SD-O



h	max
90 mm	30 kg
180 mm	40 kg
280 mm	40 kg



C57SD-G



C57SD-R

		CHF	📦	🚚
C57SD-O	RAL 2011	4,140.00	1	057001004
C57SD-G	RAL 7016	4,140.00	1	057001204
C57SD-R	RAL 3000	4,140.00	1	057001404

C57SB

Établi MasterCargo

- Modèle avec paroi porte-outils (C57P) et deux blocs à tiroirs.

Bloc à tiroirs composé de 5 tiroirs de 588x367 mm dont 3 de 90 mm de haut, 1 de 180 mm de haut et 1 de 280 mm, montés sur glissières à billes de précision. Prévus pour l'insertion de plateaux thermoformés. Serrure centralisée.

Paroi porte-outils avec 2 trous à l'arrière pour la fixation au mur. Volet roulant en aluminium à mouvement vertical, avec serrure de sécurité. Trois panneaux perforés amovibles pour le support des outils.

Plan de travail en bois contre-plaqué stratifié, avec revêtement en laminé plastique, avec 3 trous pour l'installation d'un étau 1599F/150 (en option).



C57S/B-O

243 kg



C57S/B-G



C57S/B-R



h	max
90 mm	30 kg
180 mm	40 kg
280 mm	40 kg

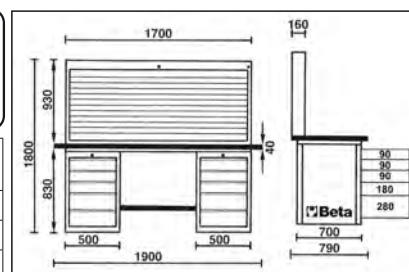

		CHF		
C57S/B-O	RAL 2011	7,390.00	1	057001006
C57S/B-G	RAL 7016	7,390.00	1	057001206
C57S/B-R	RAL 3000	7,390.00	1	057001406

C57SC

Établi MasterCargo

- Modèle avec deux blocs à tiroirs.

Bloc à tiroirs composé de 5 tiroirs de 588x367 mm dont 3 de 90 mm de haut, 1 de 180 mm de haut et 1 de 280 mm, montés sur glissières à billes de précision. Prévus pour l'insertion de plateaux thermoformés. Serrure centralisée.

Plan de travail en bois contre-plaqué stratifié, avec revêtement en laminé plastique, avec 3 trous pour l'installation d'un étau 1599F/150 (en option).



C57S/C-O



h	max
90 mm	30 kg
180 mm	40 kg
280 mm	40 kg



C57S/C-G



C57S/C-R

		CHF		
C57S/C-O	RAL 2011	5,580.00	1	057001003
C57S/C-G	RAL 7016	5,580.00	1	057001203
C57S/C-R	RAL 3000	5,580.00	1	057001403

196 kg

C57SP

Paroi porte-outils

Paroi porte-outils avec 3 trous à l'arrière pour la fixation au mur.
Volet roulant en aluminium, à mouvement vertical, avec serrure de sécurité.
Trois panneaux perforés amovibles pour le support des outils.

46 kg

		CHF		
C57SP-O	RAL 2011	1,810.00	1	057001020
C57SP-G	RAL 7016	1,810.00	1	057001220
C57SP-R	RAL 3000	1,810.00	1	057001420



C57SP G

C57SP R

5700LAMP

Lampe d'éclairage pour établi MasterCargo

- Structure en tôle d'acier robuste formée de quatre éléments; munie de vis d'assemblage.
- Bande LED de 1120 lumens, 4000K, 14W
- Alimentation 230V.
- Fournie sans câble.

9 kg

	CHF		
5700LAMP	425.00	1	057000005



C58P

Paroi porte-outils

- Rideau déroulant verticalement en aluminium peint avec serrure de sécurité
- Deux panneaux perforés amovibles pour le support des outils

46,8 kg

		CHF		
C58P-O	RAL 2011	1,370.00	1	058000221
C58P-G	RAL 7016	1,370.00	1	058000222
C58P-R	RAL 3000	1,370.00	1	058000223



C58P-G



C58P-R



C58P-O



PV

Panneau mural porte-outils

	LxA mm		CHF		
PV1	1000x920	10,2	244.00	1	088880010
PV1,5	1500x920	14,2	324.00	1	088880015

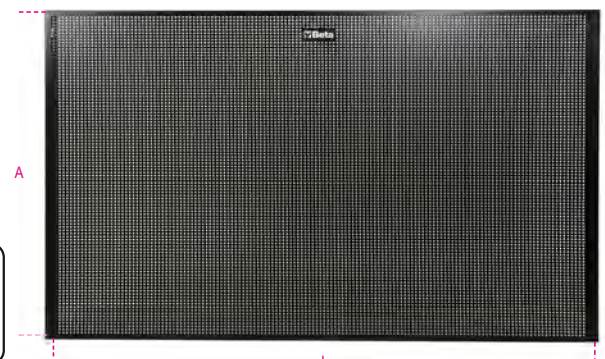

C56W

Établi de travail avec plan en bois

- Plan de travail en bois contre-plaqué stratifié avec trous pour l'installation d'un étau (1599F/125 en option).
- Structure en acier avec 6 pieds de support
- Capacité de chargement : 1.200 kg
- Ajout possible de la paroi porte-outils C57P, non fixable au plan de travail
- Deux tiroirs dotés de serrure.
- Prévu pour la fixation au sol

📦 86 kg



		CHF	📦	🖨️
C56W-O	RAL 2011	1,440.00	1	056000251
C56W-G	RAL 7016	1,440.00	1	056000252
C56W-R	RAL 3000	1,440.00	1	056000253

C56B

Établi avec plan de travail en bois

Caractéristiques principales :

- Plan de travail en bois contre-plaqué stratifié avec trous pour l'installation d'un étau (1599F/125 en option).
- Structure en acier avec 4 pieds de support.
- Capacité de charge statique : 800 kg.
- Compartiment inférieur

📦 54,5 kg



		CHF	📦	🖨️
C56B-O	RAL 2011	899.00	1	056000401
C56B-G	RAL 7016	899.00	1	056000402
C56B-R	RAL 3000	899.00	1	056000403

C56

Établi de travail

- Plan de travail en tôle vernie avec bord périmétral
- Structure en acier avec 6 pieds de support
- Capacité de charge statique : 1.200 Kg
- Ajout possible de la paroi porte-outils C57P, non fixable au plan de travail.
- Deux tiroirs avec serrure.
- Prévu pour la fixation au sol.

📦 82 kg



		CHF	📦	🖨️
C56-O	RAL 2011	1,215.00	1	056000201
C56-G	RAL 7016	1,215.00	1	056000202
C56-R	RAL 3000	1,215.00	1	056000203

C56M

Établi

- Plan de travail bi-matières en aluminium anti-dérapant et en caoutchouc mat
- Capacité de chargement: kg.800
- Ajout possible de la paroi porte-outils C57P, non fixable au plan de travail.
- 3 tiroirs avec serrure.

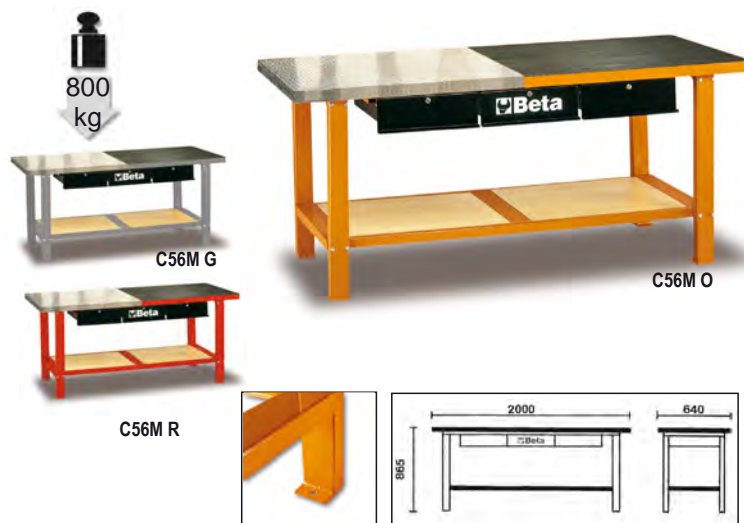

80 kg

		CHF		
C56M O	RAL 2011	1,755.00	1	056000050
C56M G	RAL 7016	1,755.00	1	056000053
C56M R	RAL 3000	1,755.00	1	056000054

C58B

Établi de travail avec plan en bois

Caractéristiques principales :

- Plan de travail en bois contre-plaqué stratifié avec trous pour l'installation d'un étau (1599F/125 en option).
- Structure en acier avec 4 pieds de support.
- Capacité de charge statique : 800 kg.
- Compartiment inférieur

44 kg



		CHF		
C58B-O	RAL 2011	806.00	1	058000401
C58B-G	RAL 7016	806.00	1	058000402
C58B-R	RAL 3000	806.00	1	058000403

C58M

Établi

Caractéristiques principales • Plan de travail entièrement en métal et revêtu d'un tapis caoutchouc antidérapant amovible

- Étagère inférieure en bois massif
- Capacité de charge statique 800 kg.
- Combinable à la paroi porte-outils C58P (ne peut pas être fixé au plan de travail)
- 2 tiroirs avec serrures
- Prééquipé pour la fixation au sol.
- Plan de travail en Aluminium C58M/PA disponible sur demande

65 kg



		CHF		
C58M-O	RAL 2011	1,127.00	1	058000300
C58M-G	RAL 7016	1,127.00	1	058000302
C58M-R	RAL 3000	1,127.00	1	058000303

C58M/PA

Plan de travail en aluminium godronné pour établi C58M

4,5 kg



C58M/PA

CHF 446.00 1 058000350

C59A

Établi "Endurance" avec 1 servante à six tiroirs

Caractéristiques principales :

- Tablette en bois contre-plaqué stratifié avec trous pour l'installation d'un étau 1599F/125 (en option).
- 6 tiroirs de 588x367 mm, montés sur glissières à billes de précision :
- 4 tiroirs hauteur 70 mm
- 1 tiroir hauteur 140 mm
- 1 tiroir hauteur 280 mm.
- Fonds des tiroirs protégés par un tapis en Néoprène.
- Façade des tiroirs en nylon haute résistance.
- Servantes prévues pour l'insertion de plateaux thermoformés.
- Serrure de sécurité centralisée frontale.
- Compartiment inférieur porte-objets.
- Prévu pour porte-papier (2400 RSC24/PC) et porte-flacons (2400 RSC24/PF-) (en option).

115 kg



C59A O



C59A A



C59A R

1500 kg



h	max
70 mm	25 kg
140 mm	30 kg
280 mm	35 kg

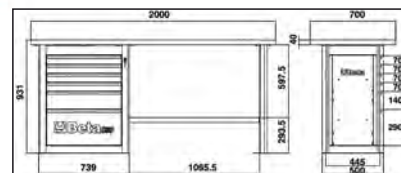

		CHF		
C59A-O	RAL 2011	2,310.00	1	059000011
C59A-A	RAL 7016	2,310.00	1	059000031
C59A-R	RAL 3000	2,310.00	1	059000051

Beta

C59B

Établi "Endurance" avec 2 servantes à six tiroirs

Caractéristiques principales :

- Tablette en bois contre-plaqué stratifié avec trous pour l'installation d'un étau 1599F/125 (en option).
- 12 tiroirs de 588x367 mm, montés sur glissières à billes de précision :
8 tiroirs hauteur 70 mm
2 tiroirs hauteur 140 mm
2 tiroirs hauteur 280 mm.
- Fonds des tiroirs protégés par un tapis en Néoprène.
- Prévus pour l'insertion de plateaux thermoformés.
- Serrure de sécurité centralisée frontale.
- Compartiment inférieur porte-objets.
- Prévus pour porte-papier (2400 RSC24/PC) et porte-flacons (2400 RSC24/PF-) (en option).

155 kg

		CHF		
C59B-O	RAL 2011	3,080.00	1	059000012
C59B-R	RAL 3000	3,080.00	1	059000052
C59B-A	RAL 7016	3,080.00	1	059000032

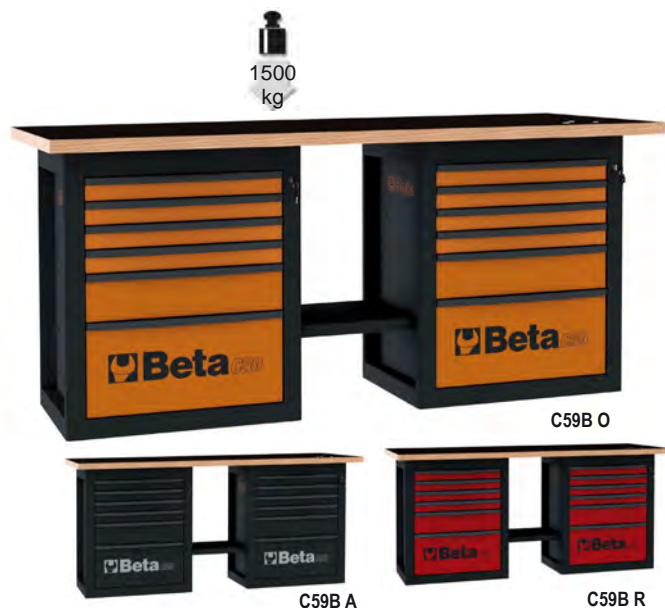

h	max
70 mm	25 kg
140 mm	30 kg
280 mm	35 kg

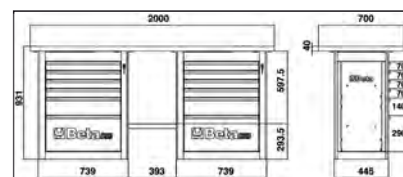

C59C

Établi "Endurance" avec 1 servante à six tiroirs, modèle court

Caractéristiques principales :

- Tablette en bois contre-plaqué stratifié avec trous pour l'installation d'un étau 1599F/125 (en option).
- 6 tiroirs de 588x367 mm, montés sur glissières à billes de précision :
4 tiroirs hauteur 70 mm
1 tiroir hauteur 140 mm
1 tiroir hauteur 280 mm.
- Fonds des tiroirs protégés par un tapis en Néoprène.
- Prévus pour l'insertion de plateaux thermoformés.
- Serrure de sécurité centralisée frontale.
- Compartiment inférieur porte-objets.
- Prévus pour porte-papier (2400 RSC24/PC) et porte-flacons (2400 RSC24/PF-) (en option).

105 kg

		CHF		
C59C-O	RAL 2011	2,090.00	1	059000013
C59C-R	RAL 3000	2,090.00	1	059000053
C59C-A	RAL 7016	2,090.00	1	059000033

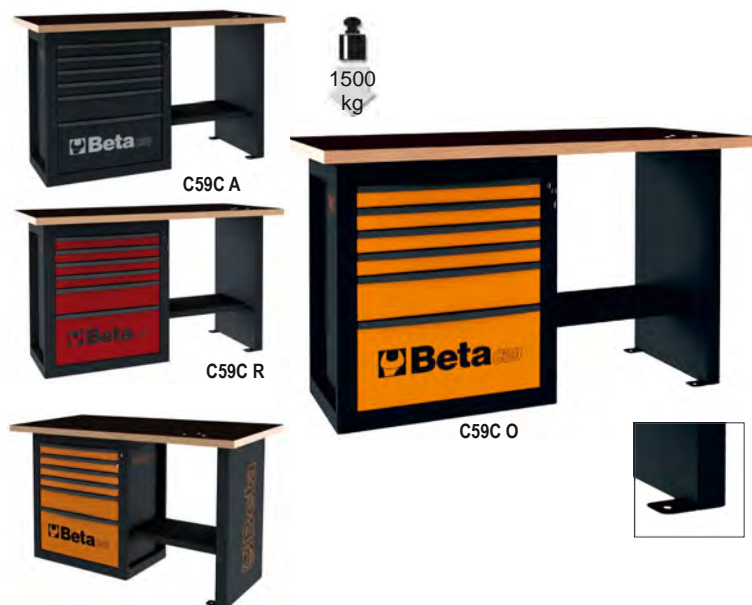

h	max
70 mm	25 kg
140 mm	30 kg
280 mm	35 kg

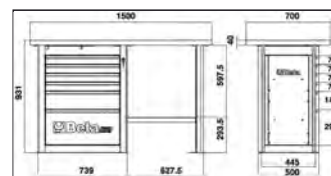

9562T2

Tapis pour établi de travail 200x160 cm

- Protège le sol contre les fuites d'huile et d'essence et respecte l'environnement
- Facile à nettoyer, en caoutchouc et antidérapant



	L cm	CHF		
9562T2	200	301.00	1	095620200



AMEUBLEMENT DE L'ATELIER



Beta Utensili, pour répondre aux exigences d'un marché de plus en plus tourné vers la qualité, le design et la personnalisation, a créé "Racing System C55" : un mobilier modulaire pour atelier qui offre la possibilité de créer un environnement de travail moderne, modelé sur vos nécessités.

Qualité

La meilleure qualité Beta "Made in Italy" pour agencer votre atelier

Organisation

Un atelier organisé de manière rationnelle permet d'optimiser le travail

Modularité

Atelier composable en fonction de vos espaces et de vos exigences



Design

Finitions recherchées et captivantes pour faire en sorte que l'atelier soit agréable et en ordre





MADE IN ITALY

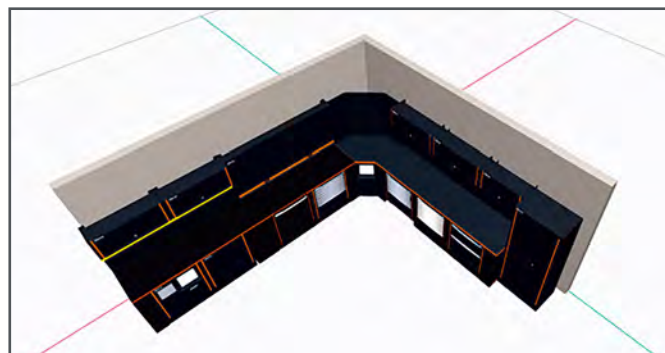

Configurez en ligne votre atelier
Visitez **www.rsc55.com**



L'atelier à vos couleurs!

RSC55 vous offre la possibilité de commander les établis et la paroi avec volet en version neutre (grise), et de compléter votre personnalisation avec les empiècements verticaux colorés à commander parmi les 7 différents rubans adhésifs.

**1. Commandez vos modules
avec couleur neutre**

2. Commandez l'empiècement vertical

Choisissez la couleur en fonction de vos goûts
ou des couleurs de votre entreprise.

C55

Combinaison complète d'ameublement de l'atelier RSC55

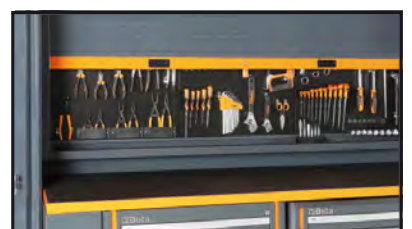

Combinaison complète composée de :

- Armoire à 1 porte (C55A1)
- Armoire à 2 portes (C55A2)
- Établi (C55BO/2)
- Établi avec prises (C55PRO BO/2)
- Servante mobile à 7 tiroirs (C55C7)
- Module fixe à 2 grands tiroirs (C55M2)
- Module fixe à 7 tiroirs (C55M7)
- Module fixe de service (C55MS)
- Paroi avec meubles hauts (C55/2PM)
- Parois porte-outils avec volet roulant (C55PS-O)

C55AB

Combinaison d'ameublement de l'atelier RSC55

Combinaison composée de :

- Armoire à 2 portes (C55A2)
- Établi (C55BO/2)
- Module fixe à 7 tiroirs (C55M7)
- Module fixe de service (C55MS)
- Paroi avec meubles hauts (C55/2PM)

407 kg



C55AB

CHF 11,420.00 1 055000020



C55PB/3

Combinaison d'ameublement de l'atelier RSC55

Combinaison composée de :

- Établi (C55BO/2)
- Module servante mobile d'atelier à 8 tiroirs (C55C8)
- Module fixe à 2 grands tiroirs (C55M2)
- Paroi porte-outils avec volet roulant (C55PS-O)

334 kg



C55PB/3

CHF 9,620.00 1 055000035



C55B/2

Établi de 2 mètres pour ameublement atelier RSC55

Avec plan de travail 2050x700 mm revêtu d'une couche en PVC antichoc et anti-écaillage résistante aux huiles et hydrocarbures

- Trous pour l'installation d'un étau (1599F/150 en option)
- Pieds réglables en hauteur

105 kg

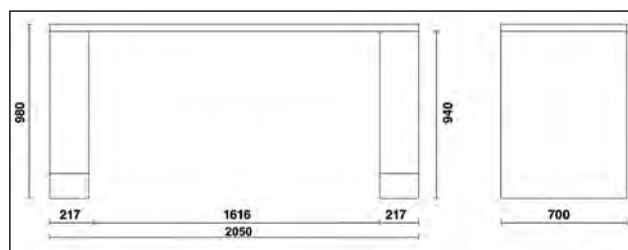
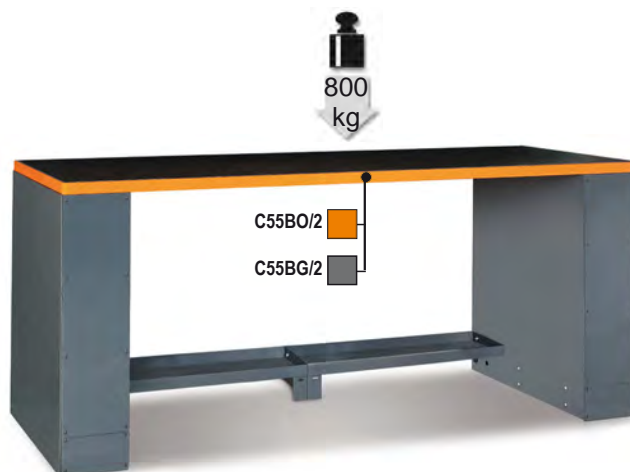

	CHF		
C55BO/2	2,650.00	1	055000101
C55BG/2	2,650.00	1	055000111

C55PRO B/2

Établi en tôle de 2 mètres pour ameublement atelier RSC55

Avec plan de travail (2050x700 mm) revêtu d'une couche de PVC antichoc et anti rayures et résistante aux huiles et aux hydrocarbures

Prises électriques et enrouleur intégré

- Prise Schuko +16+10A
- Prise EU Plug 10A
- Prise pour air comprimé avec enrouleur intégré I, Ø 8 mm, Longueur: 10 m.
- Trous pour l'installation d'un étau 1599P/150 (non inclus)
- Pieds réglables en hauteur

110 kg

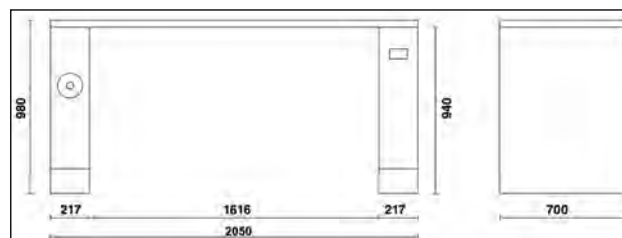
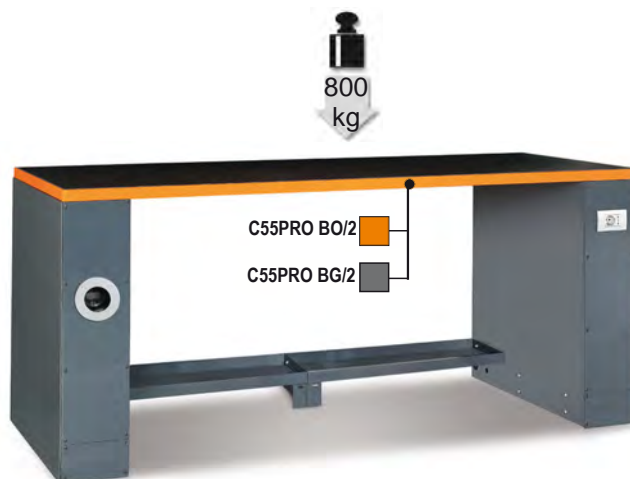

	CHF		
C55PRO BO/2	3,350.00	1	055000151
C55PRO BG/2	3,350.00	1	055000171

C55B/2,8

Établi de 2,8 mètres pour ameublement atelier RSC55

Avec plan de travail 2850x700 mm revêtu d'une couche en PVC antichoc et anti-écaillage résistante aux huiles et hydrocarbures

- Trous pour l'installation d'un étau 1599F/150 (en option)
- Pieds réglables en hauteur

129 kg

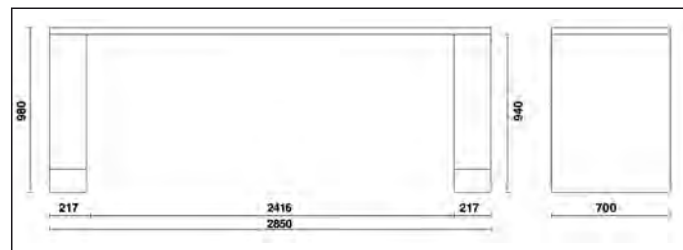
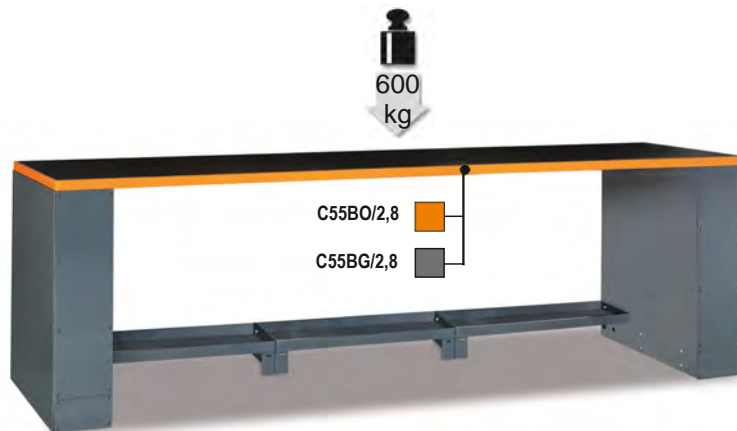

	CHF		
C55BO/2,8	3,320.00	1	055000261
C55BG/2,8	3,320.00	1	055000281

C55PRO B/2,8

Établi de 2,8 mètres pour ameublement atelier RSC55

Plan de travail en tôle vernie (2850x700 mm) revêtu d'une couche en PVC antichoc et anti rayure résistante aux huiles et aux hydrocarbures

Prises et enrouleur intégrés :

- Prise Schuko +16+10A
- Prise EU Plug 10A
- Prise pour air comprimé avec enrouleur intégré Ø 8 mm, Longueur : 10 m.
- Trous prévus pour l'installation d'un étau 1599F/150 (non inclus)
- Pieds réglables en hauteur

134 kg

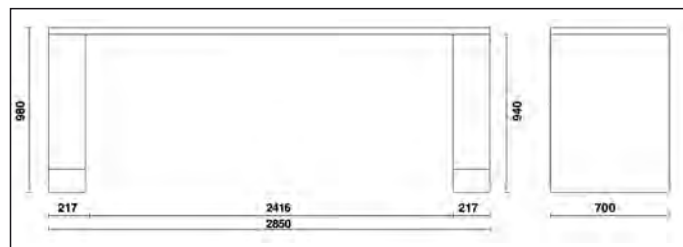
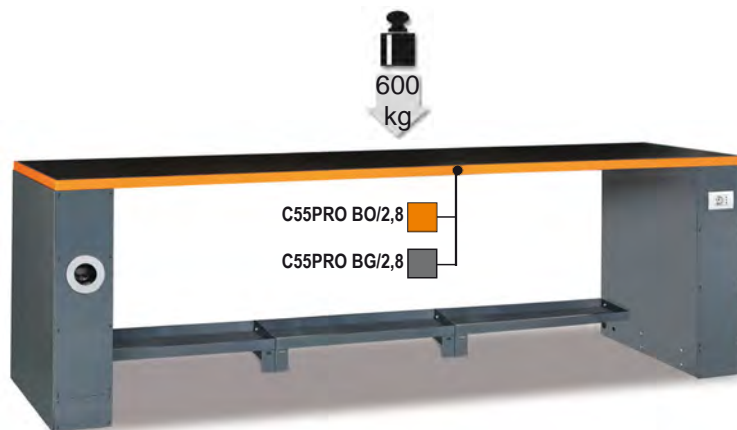

	CHF		
C55PRO BO/2,8	4,020.00	1	055000271
C55PRO BG/2,8	4,020.00	1	055000283

C55B-D4

Établi de travail double de 4 mètres avec pied central

Avec plan de travail 4100x700 mm revêtu d'une couche en PVC antichoc et anti-écaillage résistante aux hydrocarbures

- Trous pour l'installation d'un étau (1599F/150 en option)
- Pieds réglables en hauteur
- Pied central double avec compartiment porte-objets et porte de fermeture escamotable

185 kg

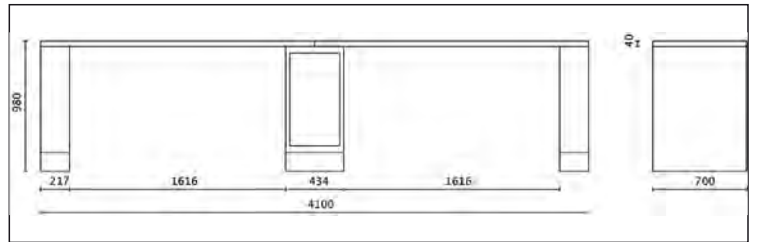
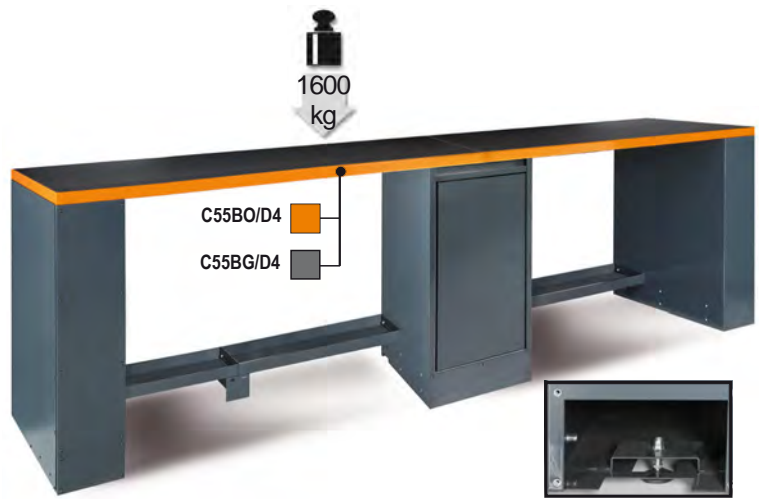

C55BO-D4	CHF	5,390.00	1	055000109
C55BG-D4	CHF	5,390.00	1	055000119

C55PRO B-D4

Etabli double de 4 mètres avec pied central et équipé d'une prise électrique et d'un enrouleur d'air pour ameublement atelier RSC55

Plan de travail en tôle vernie (4100x700 mm) revêtu d'une couche en PVC antichoc et anti rayure résistante aux huiles et aux hydrocarbures

Prises et enrouleur intégrés :

- Prise Schuko +16+10A
- Prise EU Plug 10A
- Prise pour air comprimé avec enrouleur intégré Ø 8 mm, Longueur : 10 m.
- Trous prévus pour l'installation d'un étau 1599F/150 (non inclus)
- Pieds réglables en hauteur Double pied central avec compartiment et porte escamotable 365x750mm

190 kg

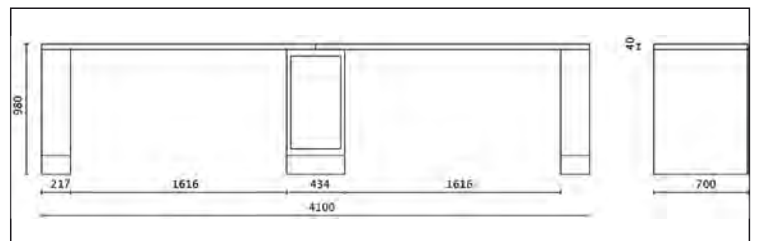
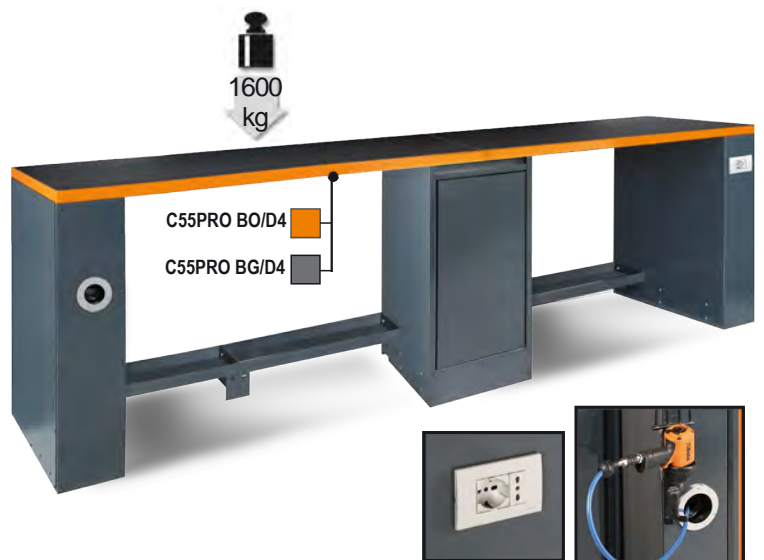

C55PRO-BO-D4	CHF	6,090.00	1	055000159
C55PRO-BG-D4	CHF	6,090.00	1	055000179

Beta

C55B/G

Pied universel pour établi ameublement atelier

- Doté de pieds réglables en hauteur
- Utilisable sur les deux côtés de l'établi
- Accès avant et latéral

📦 30 kg

C55B/G CHF 713.00 1 055000096

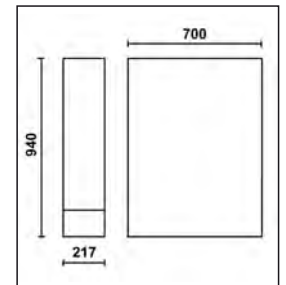

C55B/GAA

Pied universel pour ameublement atelier RSC55 avec enrouleur de tuyau intégré

- Enrouleur automatique de tuyau intégré pour air comprimé ou eau froide Ø 8 mm
- Longueur du tuyau : 10 m
- Pied réglable en hauteur
- Possibilité d'accès frontal ou latéral

📦 35 kg

C55B/GAA CHF 1,245.00 1 055000099

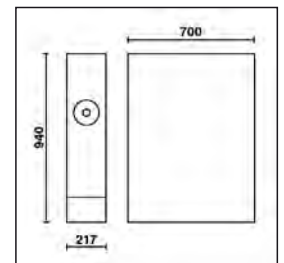

C55B/GDP

Double pied pour établis adjacents ameublement atelier

Compartiment pour support rouleaux de papier
Compartiment porte-objets avec porte
Doté de pieds réglables en hauteur

📦 45 kg

C55B/GDP CHF 1,690.00 1 055000292

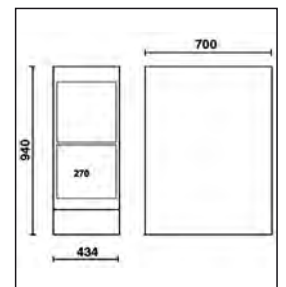

C55B/GDS

Pied double pour établis adjacents pour mobilier d'atelier RSC55

Compartiment porte-objets avec porte de fermeture escamotable 365x750 mm
Doté de pieds réglables en hauteur

📦 45 kg

C55B/GDS CHF 1,520.00 1 055000291

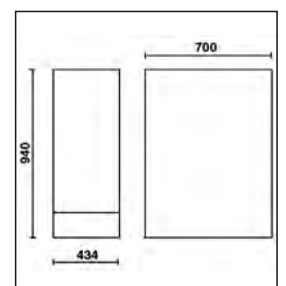

C55B/GE

Pied universel avec prises électriques pour établi ameublement atelier

- Prise Schuko+16+10A
- Prise EU Plug +10A
- Doté de pieds réglables en hauteur
- Accès avant et latéral

📦 30 kg

C55B/GE CHF 877.00 1 055000097

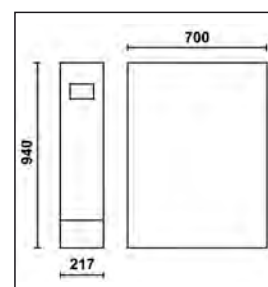

C55B/GAE

Pied universel pour ameublement atelier RSC55 avec enrouleur électrique intégré

- Enrouleur automatique de câble électrique avec prise Schuko.
- Longueur de câble 15 m
- Avec protection thermique
- Pied réglable en hauteur
- Possibilité d'accès frontal ou latéral

📦 35 kg

C55B/GAE CHF 1,340.00 1 055000094

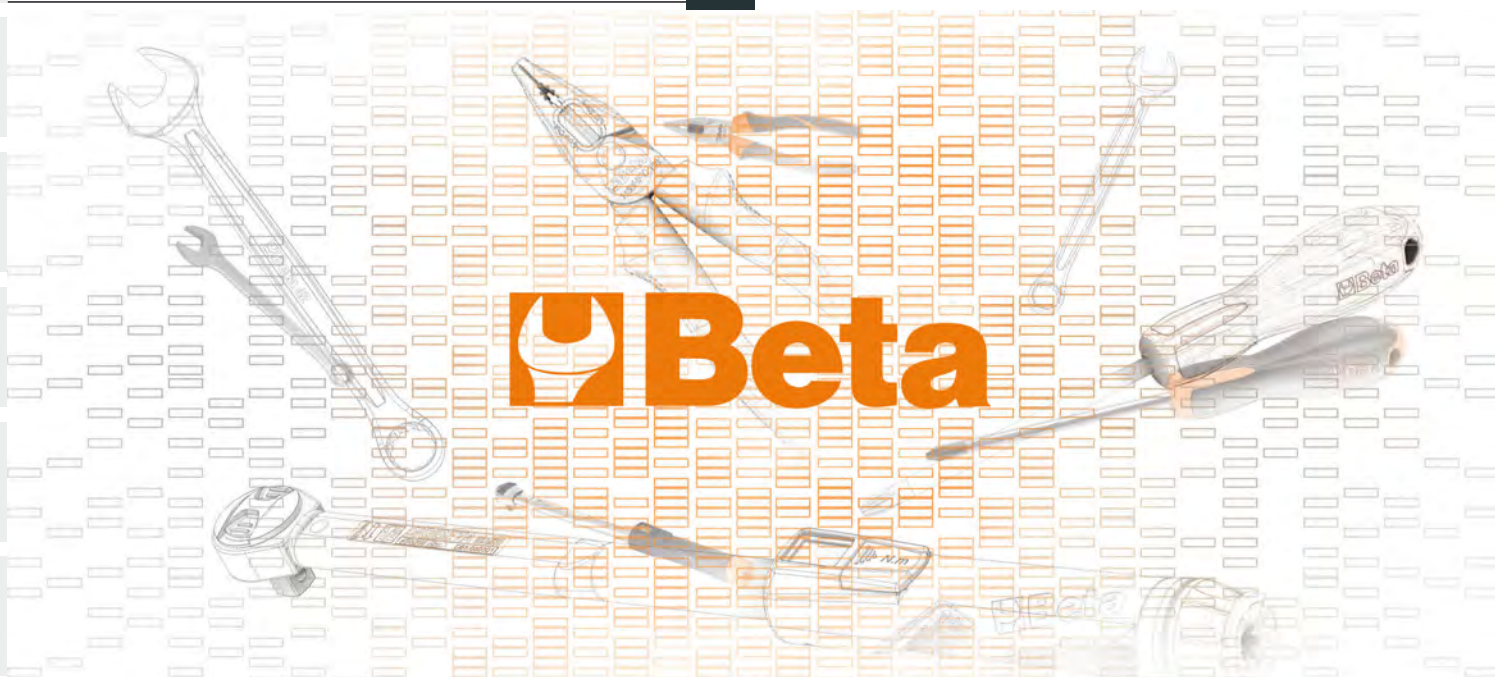
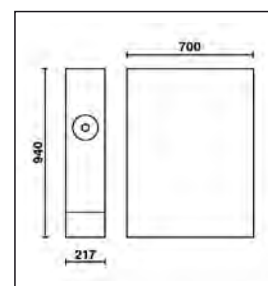
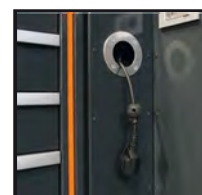

 **Beta**

C55/PL-1,024

Plan de travail d'1 mètre pour extension sur ameublement atelier RSC55

Plan de travail en tôle vernie (1024x700 mm) revêtu d'une couche en PVC antichoc et anti rayure et résistante aux huiles et aux hydrocarbures

21 kg

	CHF		
C55/PLO-1,024	588.00	1	055000130
C55/PLG-1,024	588.00	1	055000131



C55B PT/2

Plan de travail de 2 mètres pour établi ameublement atelier RSC55

Plan de travail en tôle vernie (2050x700 mm) revêtu d'une couche en PVC antichoc et anti rayure et résistante aux huiles et aux hydrocarbures
Trous prévus pour l'installation d'un étau 1599P/150 (non inclus)

43 kg

	CHF		
C55B PT/2	1,225.00	1	055000106
C55BG PT/2	1,225.00	1	055000116

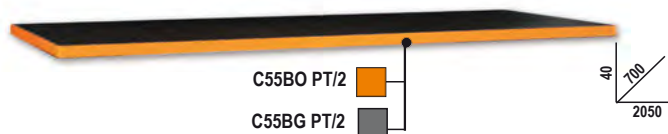

C55B PT/2,8

Plan de travail de 2,80 mètres pour établi ameublement atelier RSC55

Plan de travail en tôle vernie (2850x700 mm) revêtu d'une couche en PVC antichoc et anti rayure et résistante aux huiles et aux hydrocarbures
Trous prévus pour l'installation d'un étau 1599P/150 (non inclus)

61 kg

	CHF		
C55BO PT/2,8	1,895.00	1	055000266
C55BG PT/2,8	1,895.00	1	055000286



C55RB

Revêtement en PVC antichoc, anti-rayure, résistant aux hydrocarbures

Pour protéger le plan de travail.

C55RB/2: pour établi de 2 mètres

C55RB/2,8: pour établi de 2,8 mètres

C55RB/0,7: pour établi de 700x700mm

C55RB/1: pour établi de 1 mètre

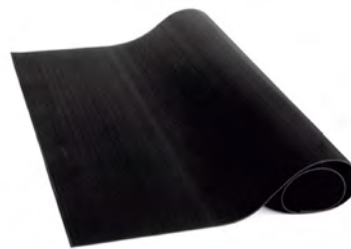

	CHF		
C55RB/2	207.00	1	055000195
C55RB/2,8	281.00	1	055000196
C55RB/0,7	115.50	1	055000199
C55RB/1	157.00	1	055000198

C55B/VS

Étrier inférieur de soutien d'établissements

Dimensions 800x230x60 mm

4 kg

	CHF		
C55B/VS	157.00	1	055000095

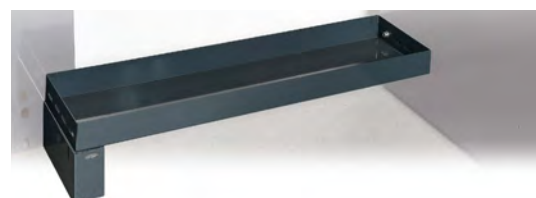

C55C7

Servante mobile d'atelier à 7 tiroirs pour ameublement atelier

- 7 tiroirs de 588x367 mm, montés sur glissières à billes de précision
- 4 roues de Ø 100 mm, 2 fixes (dont une avec frein) et 2 pivotantes
- Système d'ouverture en aluminium sur toute la longueur du tiroir
- Fond des tiroirs protégé par un tapis en Néoprène
- Serrure centralisée frontale
- Tiroirs conçus pour l'emplacement des thermoformés

79 kg

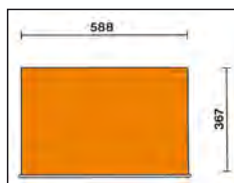

h	max
70 mm	30 kg
245 mm	40 kg

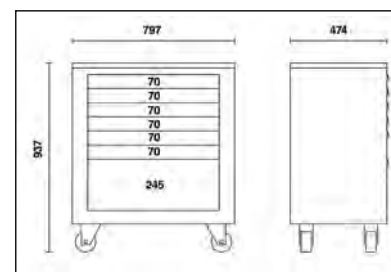

C55C7

CHF 2,455.00 1 055000201

Beta

C55C8

Module servante mobile d'atelier à 8 tiroirs pour ameublement atelier

- 8 tiroirs de 588x367 mm, montés sur glissières à billes de précision
- 4 roues de Ø 100 mm, 2 fixes (dont une avec frein) et 2 pivotantes
- Système d'ouverture en aluminium sur toute la longueur du tiroir
- Fond des tiroirs protégé par un tapis en Néoprène
- Serrure centralisée frontale
- Tiroirs conçus pour l'emplacement des thermoformés

81 kg



h	max
70 mm	30 kg
175 mm	40 kg

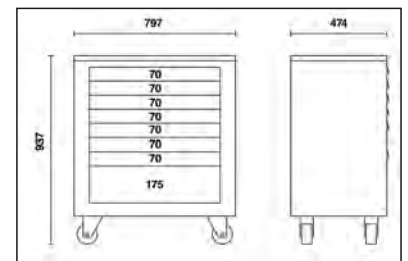
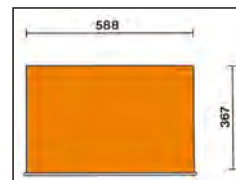

C55C8

CHF 2,490.00 1 055000206

C55M2

Module fixe à 2 tiroirs pour ameublement atelier

- 2 tiroirs de 588x367mm, montés sur glissières à billes de précision
- Système d'ouverture en aluminium sur toute la longueur du tiroir
- Fond des tiroirs protégé par un tapis en Néoprène
- Serrure centralisée frontale

66 kg



h	max
280 mm	40 kg
385 mm	40 kg

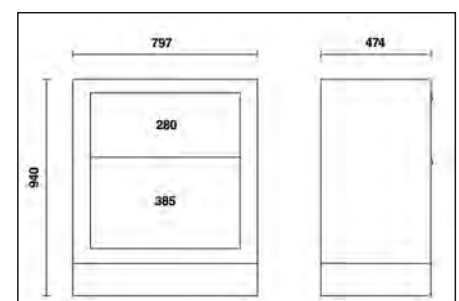
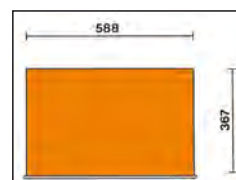

C55M2

CHF 2,085.00 1 055000202

C55M4

Module fixe à 4 tiroirs pour ameublement atelier

4 tiroirs de 588x367 mm, montés sur glissières à billes de précision

- Système d'ouverture en aluminium sur toute la longueur du tiroir
- Fond des tiroirs protégé par un tapis en Néoprène
- Serrure centralisée frontale

📦 75 kg

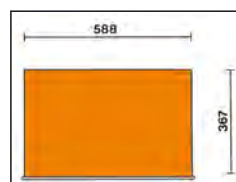

h	max
140 mm	30 kg
245 mm	40 kg

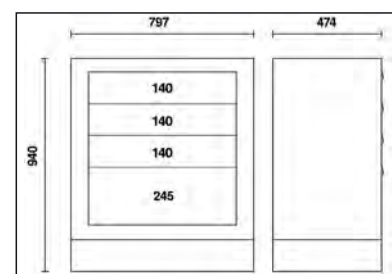

C55M4 CHF 2,190.00 1 055000212

C55M7

Module fixe à 7 tiroirs pour ameublement atelier

7 tiroirs de 588x367 mm, montés sur glissières à billes de précision

- Système d'ouverture en aluminium sur toute la longueur du tiroir
- Fond des tiroirs protégé par un tapis en Néoprène
- Serrure centralisée frontale
- Tiroirs conçus pour l'emplacement des thermoformés

📦 78 kg

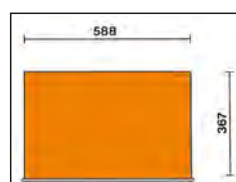

h	max
70 mm	30 kg
245 mm	40 kg

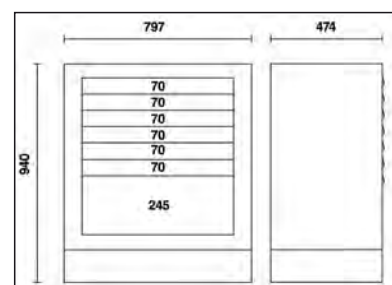

C55M7 CHF 2,320.00 1 055000203

C55M8

Module fixe à 8 tiroirs pour ameublement atelier

8 tiroirs de 588x367 mm, montés sur glissières à billes de précision

- Système d'ouverture en aluminium sur toute la longueur du tiroir
- Fond des tiroirs protégé par un tapis en Néoprène
- Serrure centralisée frontale
- Tiroirs conçus pour l'emplacement des thermoformés

📦 78,9 kg



h	max
70 mm	30 kg
175 mm	40 kg

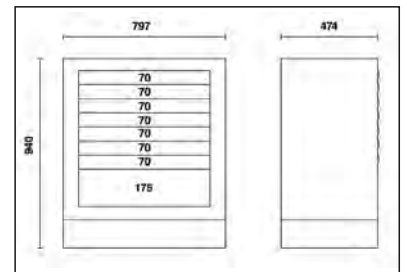
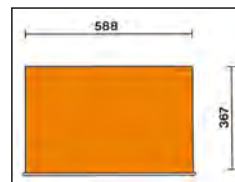

C55M8

CHF 2,370.00 1 055000207

C55CS

Module fixe pour tri des déchets pour ameublement atelier

- Compartiment déchets extractible 588x465 mm monté sur glissières à billes de précision
- 2 grands conteneurs internes extractibles pour le tri des déchets

📦 62 kg

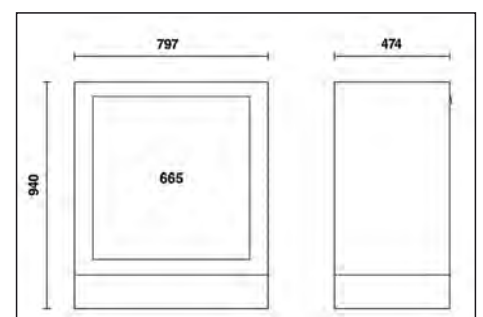

C55CS

CHF 2,115.00 1 055000208

C55MA

Module fixe à 2 portes opur ameublement atelier

- Système d'ouverture push-pull à pression• Avec serrure• Rayon interne réglable en hauteur

📦 75 kg

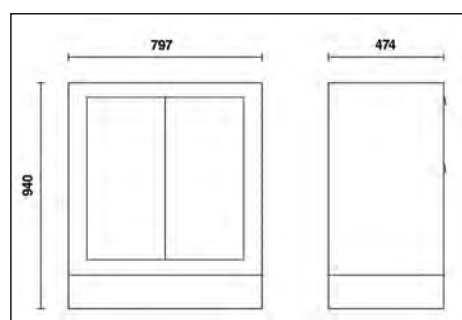

C55MA

CHF 1,800.00  1  055000205

C55MDO

Module fixe de distribution d'huile pour ameublement atelier

- 2 enrouleurs avec tuyau flexible de 7 m - 1/2" compris
- Fourni avec 2 pistolets équipés de compte-litres numérique et équipés de ramasse-gouttes automatique
- débit max. : 35 l/mn
- viscosité : 8+5000 mPas

📦 94 kg

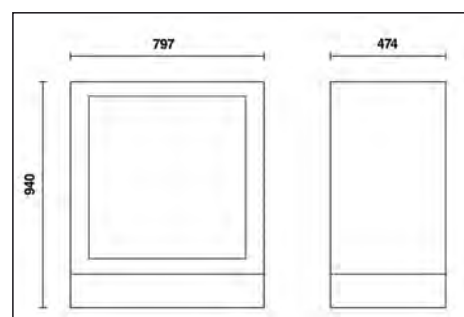

C55MDO

CHF 4,430.00  1  055000210

C55MS

Module fixe de service pour ameublement atelier

- Poubelle incorporée
- Compartiment pour rouleaux de papier préforés
- Soute porte-objets 305x270 mm

75 kg

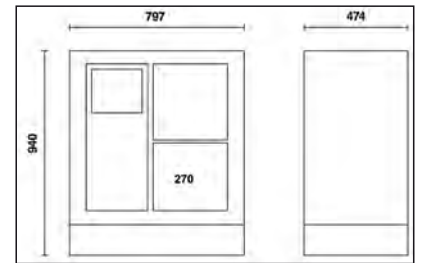

C55MS

CHF 1,905.00 1 055000204

C55T3

Chariot d'atelier

- 3 plateaux revêtus de caoutchouc antidérapant
- Poignée ergonomique
- Double possibilité de fixation du plateau central
- 4 roues Ø 100 mm pivotantes (dont deux avec frein)
- Capacité de charge statique : 200 kg (répartie sur les 3 étagères)

21 kg

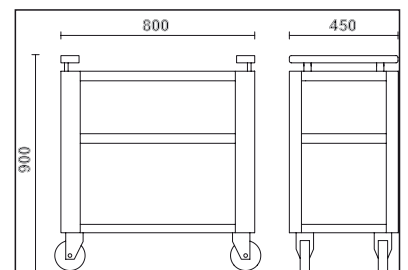

C55T3

CHF 356.00 1 055000219

C55P/MCD

Montants centraux intermédiaires doubles

10 kg

C55P/MCD CHF 181.00 1 055000257



C55P/2MDX-SX

Couple de montants droite-gauche parois

10 kg

C55P/2MDX-SX CHF 331.00 1 055000253



C55PM

Meuble haut de 1 mètre pour établi ameublement atelier

• Dimensions 1024x400x300 mm, avec ressorts à gaz pour faciliter l'ouverture/fermeture de la porte

24 kg

C55PM CHF 1,205.00 1 055000302

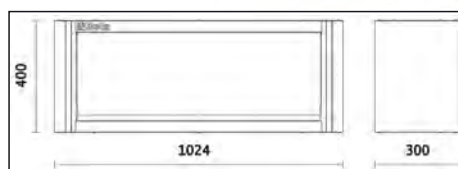

C55PFA-1,0

Panneau foré autoportant de 1 mètre pour ameublement atelier

Panneau foré en acier 1024x1020x25 mm pour le support des outils

11 kg

C55PFA-1,0 CHF 405.00 1 055000316

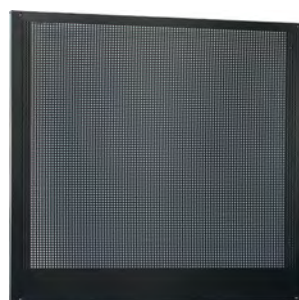

C55/PF

Panneau foré sous meuble haut de 1 mètre pour ameublement atelier

• Panneau foré 1024x600 mm pour accrocher les outils, à superposer à C55PT1,0x0,6

6 kg

C55/PF CHF 279.00 1 055000307

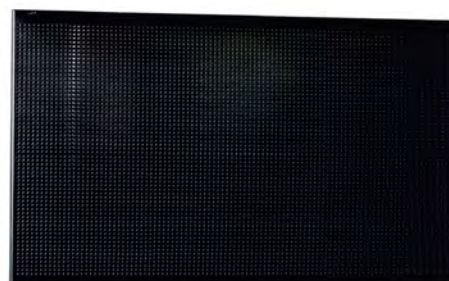

C55PT1,0X0,6

Panneau sous meuble haut de 1 mètre

Dimensions 1024x620x25 mm

8 kg

C55PT1,0X0,6

CHF 222.50 1 055000314



C55PTE-1,0

Panneau sous meuble haut de 1 mètre

Dimensions 1024x620x25 mm

Avec prédisposition pour 2 prises électriques (non comprises)

8 kg

C55PTE-1,0

CHF 265.00 1 055000319



C55/2PM

Paroi avec meubles hauts pour ameublement atelier

- 2 meubles hauts, 1024x400x300 mm, avec ressorts à gaz pour faciliter l'ouverture/fermeture de la porte.
- Panneau mural 2050x620 mm prévu pour le logement des panneaux porte-outils perforés C55/PF (en option)
- Fournie avec structure portante
- Possibilité d'assortiment à l'établi de 2 mètres.

80 kg

C55/2PM

CHF 3,370.00 1 055000301

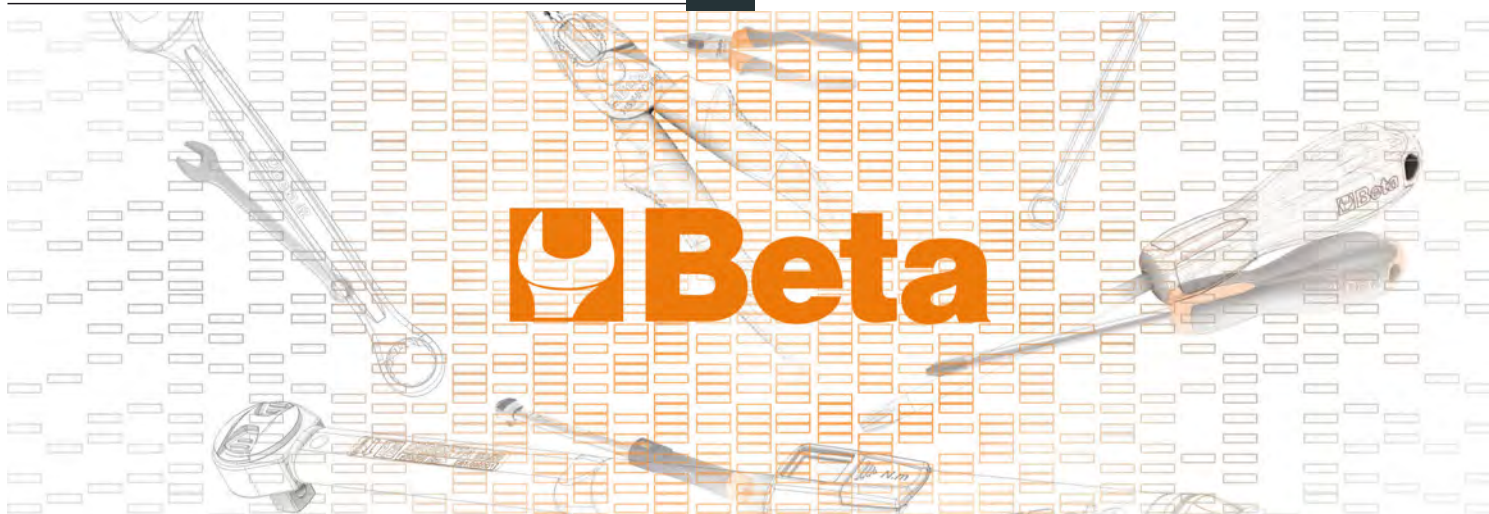
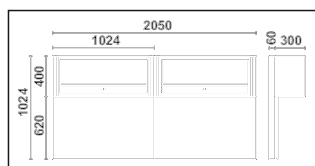

C55PFA-0,8

Panneau foré autoportant de 0,8 mètres pour ameublement atelier

Panneau foré en acier 800x1020x25 mm pour le support des outils

10 kg

C55PFA-0,8 CHF 373.00 1 055000315



C55PM/M0,8

Meuble haut de 0,8 mètres pour ameublement atelier

Dimensions 800x400x300 mm, avec ressorts à gaz pour faciliter l'ouverture/fermeture de la porte

19 kg

C55PM/M0,8 CHF 1,159.00 1 055000312

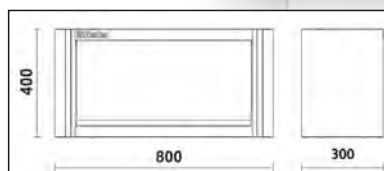

C55PTE-0,8

Panneau sous meuble haut de 0,8 mètres

Dimensions 800x620x25 mm
Avec prédisposition pour 1 prise électrique (non comprise)

6 kg

C55PTE-0,8 CHF 239.50 1 055000318



C55PT0,8X0,6

Panneau sous meuble haut de 0,8 mètres

Dimensions 800x620x25 mm

7,8 kg

C55PT0,8X0,6 CHF 207.00 1 055000313



C55/1PF

Panneau perforé porte-outils pour ameublement atelier

• Panneau perforé 800x600 mm pour le support des outils

5 kg

C55/1PF CHF 186.00 1 055000309

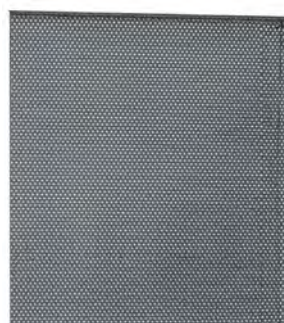

C55PS

Paroi porte-outils avec volet roulant pour ameublement atelier

- Volet roulant en aluminium à mouvement vertical avec serrure
- Panneau perforé amovible pour le support des outils
- Fournie avec structure portante
- Possibilité d'assortiment à l'établi de 2 mètres

📦 88 kg

C55PS-O	CHF	📦	🖨️
	2,395.00	1	055000250
C55PS-G	2,395.00	1	055000255

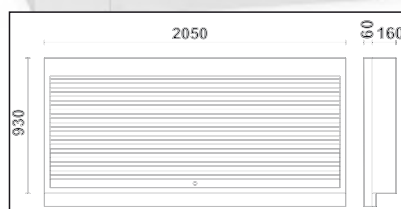

C55PSE

Paroi porte-outils avec volet roulant et prédisposition pour 2 prises électriques

- Volet roulant en aluminium à mouvement vertical avec serrure
- Panneau perforé amovible pour le support des outils
- Fournie avec structure portante
- Avec prédisposition pour prises électriques (non comprises)
- Possibilité d'assortiment à l'établi de 2 mètres

📦 88 kg

C55PSE-O	CHF	📦	🖨️
	2,420.00	1	055000258
C55PSE-G	2,420.00	1	055000260

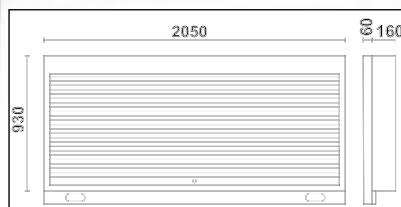

C55AE

Profil 2 mètres avec prédisposition électrique

Dimensions 2050x25x90mm
Avec prédisposition pour 2 prises électriques

📦 1,5 kg

C55AE	CHF	📦	🖨️
	222.50	1	055000325



C55AC

Angle complet autoportant

Plan de travail de 700x700 mm avec pieds
2 parois supérieures porte-outils équipées de 2 rayons pour fixation 670x160 mm

📦 66 kg



C55AC O

C55AC G



C55AC O	CHF 2,770.00	1	055000360
C55AC G	CHF 2,770.00	1	055000380

C55KAI

Élément angulaire 700x700 mm avec pieds

• Plan de travail en tôle vernie 700x700 mm revêtu d'une couche en PVC antichoc, anti-rayure, résistante aux hydrocarbures

📦 32 kg

C55KAI O	CHF 1,585.00	1	055000365
C55KAI G	CHF 1,585.00	1	055000385



C55KAI O

C55KAI G

C55KAS

Angle supérieur avec parois porte-outils

• 2 parois forées 700x1020x25 mm
• 2 rayons pour fixation 670x160 mm

📦 24 kg

C55KAS	CHF 1,174.00	1	055000370
--------	--------------	---	-----------



C55MP

Etagère métallique pour angle haut

Dimensions 670x160x80 mm

C55MP	CHF 165.50	1	055000374
-------	------------	---	-----------



C55B/1

Rallonge d'1 mètre

Plan de travail en tôle vernie 1024x700 mm revêtu d'une couche en PVC antichoc, anti-rayure, résistante aux hydrocarbures

• Pied universel doté de pieds réglables en hauteur

1 module fixe:

7 tiroirs de 588x367 mm, montés sur glissières à billes de précision

• Système d'ouverture en aluminium sur toute la longueur du tiroir

• Fond des tiroirs protégé par un tapis en Néoprene

• Serrure centralisée frontale

127 kg



C55BO/1

C55BG/1



h	max
70 mm	30 kg
245 mm	40 kg

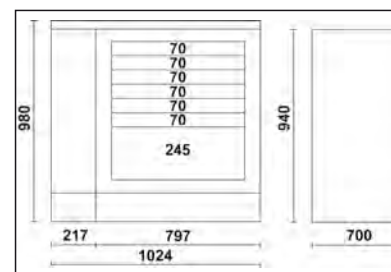
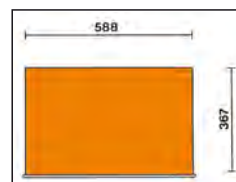

	CHF		
C55BO/1	3,620.00	1	055000090
C55BG/1	3,620.00	1	055000091

C55C

Armoire Cargo ligne RSC55

Ce modèle a été conçu après de longues recherches auprès des utilisateurs professionnels. Il offre la solution idéale pour un travail rationnel.

Deux panneaux perforés fixés sur les portes peuvent s'ouvrir et augmenter la capacité de rangement.



37 kg

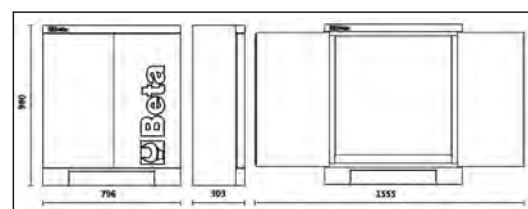

	CHF		
C55C	1,022.00	1	055000400

C55A1

Armoire en tôle à 1 porte pour ameublement atelier RSC55

- 3 tablettes amovibles réglables en hauteur
- Avec serrure
- Dimensions intérieures utiles : 177x42x42 cm

📦 50 kg

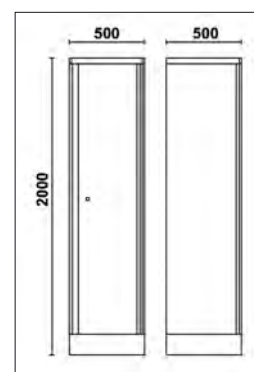

C55A1

CHF 877.00 1 055000411

C55A1/R42

étagère intérieure pour armoire C55A1 et C55AT1

📦 2,4 kg



C55A1/R42

420x420 mm

CHF 38.50 1 055000461

Beta

C55A2

Armoire en tôle à 2 portes pour ameublement atelier RSC55

- 3 tablettes amovibles réglables en hauteur
- Avec serrure
- Dimensions intérieures utiles : 177x70x42 cm

72 kg

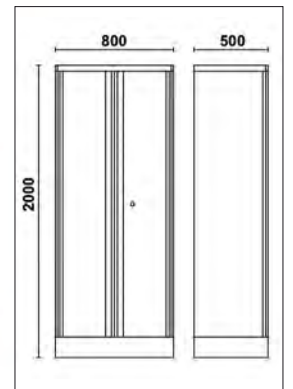

C55A2

CHF 1,174.00 1 055000412

C55A2/R70

étagère intérieure pour armoire C55A2 et C55AT2

3,5 kg



C55A2/R70

700x420 mm

CHF 61.50 1 055000462

Beta

C55AT1

Armoire en tôle à 1 porte transparente en polycarbonate pour ameublement atelier RSC55

- 3 tablettes amovibles réglables en hauteur
- Avec serrure
- Dimensions intérieures utiles : 1770x420x420 mm

41 kg

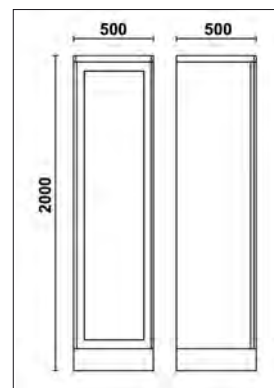

C55AT1 CHF 1,047.00 1 055000421

C55AT2

Armoire en tôle à 2 portes transparentes en polycarbonate pour ameublement atelier RSC55

- 3 tablettes amovibles réglables en hauteur
- Avec serrure
- Dimensions intérieurs utiles : 1770x700x420 mm

56 kg

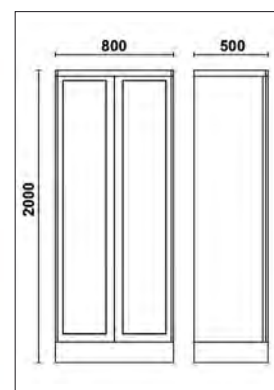

C55AT2 CHF 1,420.00 1 055000422

C55STR

Ruban adhésif coloré 25 m

Permet de personnaliser la couleur des embouts verticaux de l'ameublement d'atelier C55



RAL2011
RAL3000
RAL6029
RAL9016
RAL1023
RAL5015
RAL1035
RAL9006

	CHF		
C55STR-O/2011	89.00	1	055000901
C55STR-R/3000	89.00	1	055000903
C55STR-V/6029	89.00	1	055000906
C55STR-W/9016	89.00	1	055000907
C55STR-Y/1023	89.00	1	055000905
C55STR-B/5015	89.00	1	055000904
C55STR-GO/1035	89.00	1	055000909
C55STR-S/9006	89.00	1	055000902



ESPACE PROFESSIONNELLE ET RIGIDE

**NOUVEAU
DESIGN**

Le **C45PRO** est l'équipement d'atelier professionnel qui permet d'optimiser au mieux votre espace de travail. Avec son nouveau design 2021 et ses améliorations techniques, il est d'un excellent rapport qualité/prix.

L'équipement d'atelier modulaire **C45PRO** permet de créer son propre atelier de travail en fonction de l'espace disponible et des besoins d'utilisation. Cette gamme professionnelle et modulable basée sur des combinaisons prédéterminées, peut être complétée dans le temps.

Le poste de travail peut être entièrement personnalisé :

- plans de travail en MDF revêtu d'acier inoxydable ou en bois contre-plaqué stratifié
- nombreux éléments et accessoires disponibles.

Optimisez votre atelier afin de vous adaptez à votre environnement de travail.

Choisissez parmi les solutions préassemblées ou créez votre atelier à partir des modules disponibles.



LA COMBINAISON D'ATELIER C45PRO ÉVOLUE ET SE MET AUX COULEURS DE BETA !

Configurez votre atelier en 3D en ligne

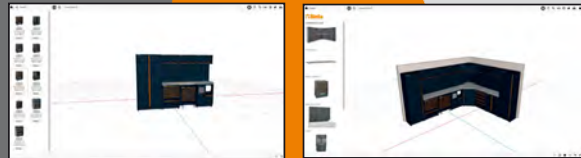

www.beta-tools.com

C45PRO X

Combinaison d'ameublement d'atelier C45PRO X

Combinaison comprenant:

- Plan de travail en MDF revêtu d'acier inoxydable (C45PX / 3-2.0MT)
- Module fixe à 7 tiroirs (C45PRO M7)
- Module de propreté (C45PRO MS)
- Cabine mobile à 7 tiroirs (C45PRO C7)
- Armoire à outils à deux portes (C45PRO AS2)
- 3 panneaux porte-outils perforés (C45PRO PF)
- 3 armoires murales (C45PRO PM)
- 3 supports muraux, type large (C45PRO SL)
- 1 support mural, type étroit (C45PRO SS)

305 kg



C45PRO X

CHF 6,190.00 1 045000001



C45PRO W

Combinaison d'ameublement d'atelier C45PRO W

Combinaison comprenant:

- Plan de travail en bois multicouche (C45PW / 3-2.0MT)
- Module fixe à 7 tiroirs (C45PRO M7)
- Module de propreté (C45PRO MS)
- Cabine mobile à 7 tiroirs (C45PRO C7)
- Armoire à outils à deux portes (C45PRO AS2)
- 3 panneaux porte-outils perforés (C45PRO PF)
- 3 armoires murales (C45PRO PM)
- 3 supports muraux, type large (C45PRO SL)
- 1 support mural, type étroit (C45PRO SS)

303 kg

C45PRO W CHF 6,030.00 1 045000002

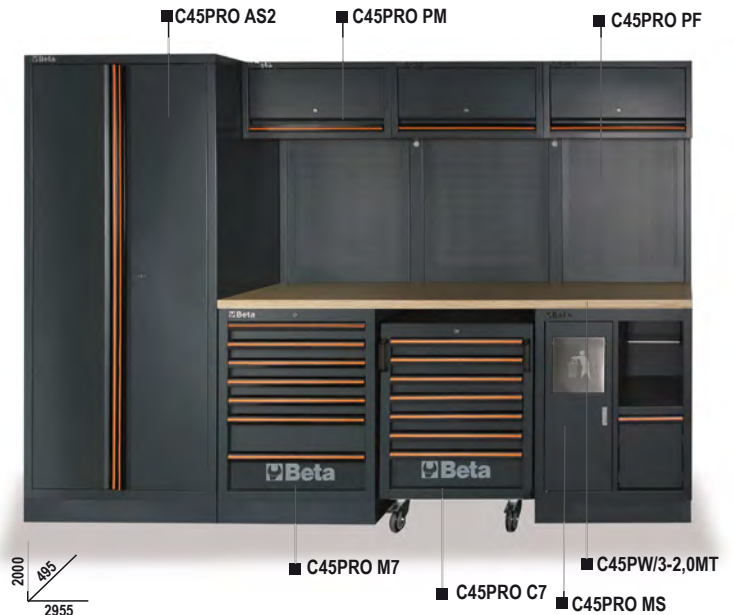

C45PRO AX

Combinaison d'ameublement d'atelier C45PRO AX

Combinaison comprenant:

- Plan de travail en MDF revêtu d'acier inoxydable (C45PX / 3-2.0MT)
- Module fixe à 7 tiroirs (C45PRO M7)
- Module de propreté (C45PRO MS)
- Module fixe à deux portes (C45PRO MA)
- 3 armoires murales (C45PRO PM)
- 3 panneaux porte-outils perforés (C45PRO PF)
- 2 supports muraux, type large (C45PRO SL)
- 2 supports muraux, type étroit (C45PRO SS)

206 kg

C45PRO AX CHF 4,300.00 1 045000003



C45PRO AW

Combinaison d'ameublement d'atelier C45PRO AW

Combinaison comprenant:

- Plan de travail en bois multicouche (C45PW / 3-2,0MT)
- Module fixe avec 2 tiroirs (C45PRO MA)
- Module fixe à 7 tiroirs (C45PRO M7)
- Module de propreté (C45PRO MS)
- 3 armoires murales (C45PRO PM)
- 3 panneaux porte-outils perforés (C45PRO PF)
- 2 supports muraux, type étroit (C45PRO SS)
- 2 supports muraux, type large (C45PRO SL)

204 kg

C45PRO AW CHF 4,140.00 1 045000004



C45PRO BX

Combinaison d'ameublement d'atelier C45PRO BX

Combinaison comprenant:

- Plan de travail en MDF revêtu d'acier inoxydable (C45PX / 2-1.3MT)
- Module fixe avec 5 tiroirs (C45PRO M5)
- Module fixe à deux portes (C45PRO MA)
- Armoire à outils à une porte (C45PRO AS1)
- 2 armoires murales (C45PRO PM)
- 2 panneaux porte-outils perforés (C45PRO PF)
- 2 supports muraux, type large (C45PRO SL)
- 1 support mural, type étroit (C45PRO SS)

191 kg

C45PRO BX

CHF 3,880.00 1 045000021

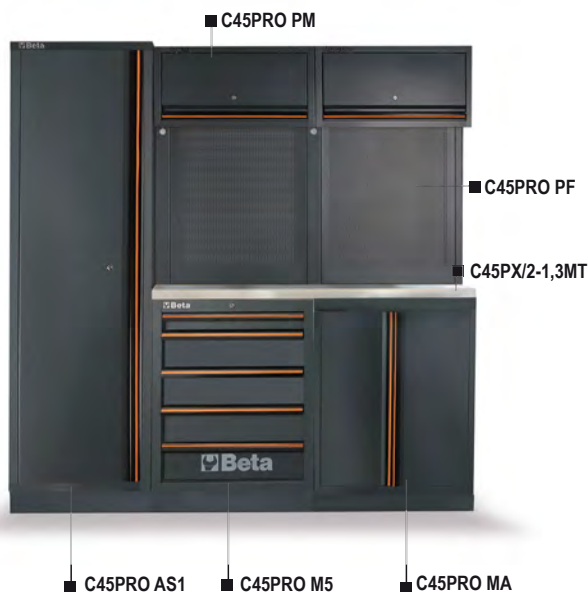

C45PRO BW

Combinaison d'ameublement d'atelier C45PRO BW

Combinaison comprenant:

- Plan de travail en bois multicouche (C45PW / 2-1.3MT)
- Module fixe avec 5 tiroirs (C45PRO M5)
- Module fixe à deux portes (C45PRO MA)
- Armoire à outils à une porte (C45PRO AS1)
- 2 armoires murales (C45PRO PM)
- 2 panneaux porte-outils perforés (C45PRO PF)
- 2 supports muraux, type large (C45PRO SL)
- 1 support mural, type étroit (C45PRO SS)

190 kg

C45PRO BW

CHF 3,720.00 1 045000022

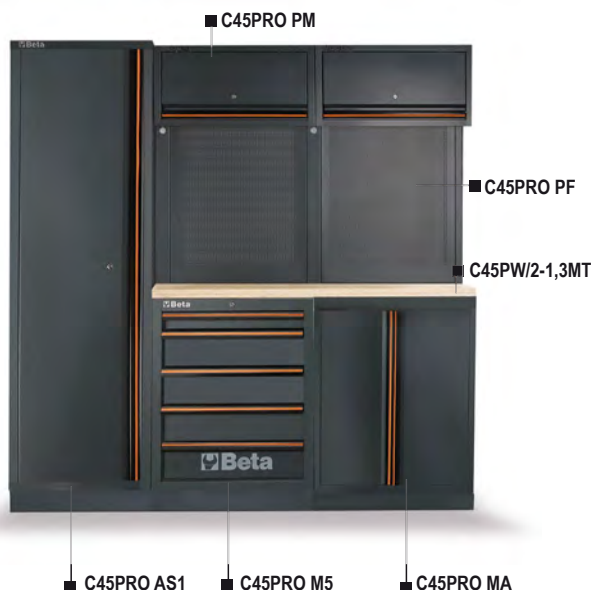

C45PRO DX

Combinaison d'ameublement d'atelier C45PRO DX

Combinaison comprenant:

- 1 plan de travail en MDF revêtu d'acier inoxydable (C45PX / 3-2,0MT)
- 1 plan de travail en MDF revêtu en acier inoxydable (C45PX / 2-1,3MT)
- 1 module fixe à 7 tiroirs (C45PRO M7)
- 1 cabine roulant mobile à 7 tiroirs (C45PRO C7)
- 1 module de propreté (C45PRO MS)
- 1 module fixe avec 5 tiroirs (C45PRO M5)
- 1 module fixe deux portes (C45PRO MA)
- 1 coin complet autoportant avec plan de travail en MDF revêtu d'acier inoxydable (C45PRO CORNER/X)
- 5 panneaux porte-outils perforés (C45PRO PF)
- 5 armoires murales (C45PRO PM)
- 7 supports muraux, type large (C45PRO SL)
- 2 supports muraux, type étroit (C45PRO SS)
- 2 armoires à une porte (C45PRO AS1)

572,3 kg

C45PRO DX

CHF 12,250.00 1 045000031

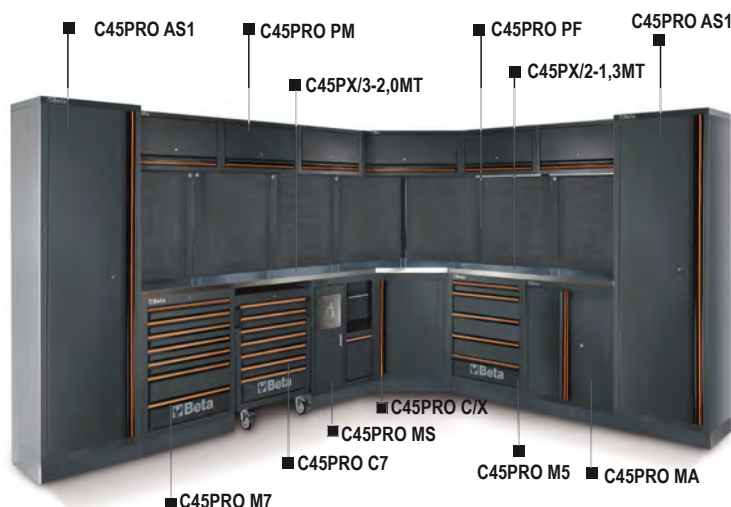

C45PRO DW

Combinaison d'ameublement d'atelier C45PRO DW

Combinaison comprenant:

- 1 plan de travail en bois multiplis (C45PW / 3-2.0MT)
- 1 plan de travail en bois multiplis (C45PW / 2-1.3MT)
- 1 module fixe à 7 tiroirs (C45PRO M7)
- 1 cabine roulant mobile à 7 tiroirs (C45PRO C7)
- 1 module de propreté (C45PRO MS)
- 1 module fixe avec 5 tiroirs (C45PRO M5)
- 1 module fixe à deux portes (C45PRO MA)
- 1 coin complet autoportant avec plan de travail en bois (C45PRO CORNER/W)
- 5 panneaux porte-outils perforés (C45PRO PF)
- 5 armoires murales (C45PRO PM)
- 7 supports muraux, type large (C45PRO SL)
- 2 supports muraux, type étroit (C45PRO SS)
- 2 armoires à une porte (C45PRO AS1)

■ 568,5 kg

C45PRO DW **CHF** 11,840.00 1 045000032

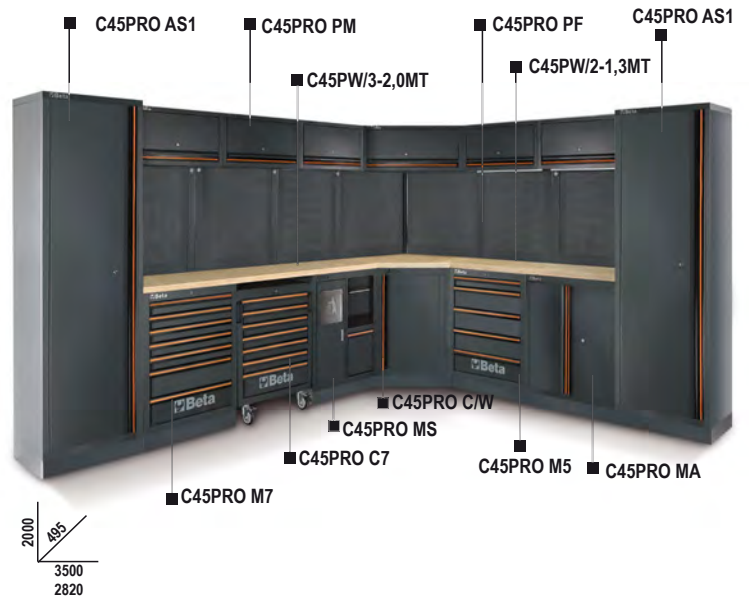

C45PRO EX

combinaison d'équipements d'atelier C45PRO avec plan de travail Inox

Combinaison comprenant:

- 2 panneaux d'outils perforés (C45PRO PF)
- 2 armoires murales (C45PRO PM)
- 2 supports muraux, de type large (C45PRO SL)
- 1 support mural, type étroit (C45PRO SS)
- 1 armoire à une porte (C45PRO AS1)
- Module fixe avec 7 tiroirs et plan de travail MDF revêtu d'acier inoxydable (C45PRO M7A/X):
- 1 tiroir, 1248x406 mm
- 6 tiroirs, 782x406 mm 5 tiroirs, 65 mm de haut 1 tiroir, 145 mm de haut
- 1 compartiment de rangement avec étagère intermédiaire et porte

■ 174,6 kg

C45PRO EX **CHF** 4,120.00 1 045000033



C45PRO EW

combinaison d'équipements d'atelier C45PRO avec plan de travail Bois

Combinaison comprenant:

- 2 panneaux d'outils perforés (C45PRO PF)
- 2 armoires murales (C45PRO PM)
- 2 supports muraux, de type large (C45PRO SL)
- 1 support mural, type étroit (C45PRO SS)
- 1 armoire à outils à porte unique (C45PRO AS1)
- Module fixe avec 7 tiroirs et plan de travail en bois multicoques (C45PRO M7A/W):
- 1 tiroir, 1248x406 mm
- 6 tiroirs, 782x406 mm 5 tiroirs, 65 mm de haut 1 tiroir, 145 mm de haut
- 1 compartiment de rangement avec étagère intermédiaire et porte

■ 173,6 kg

C45PRO EW **CHF** 3,980.00 1 045000034

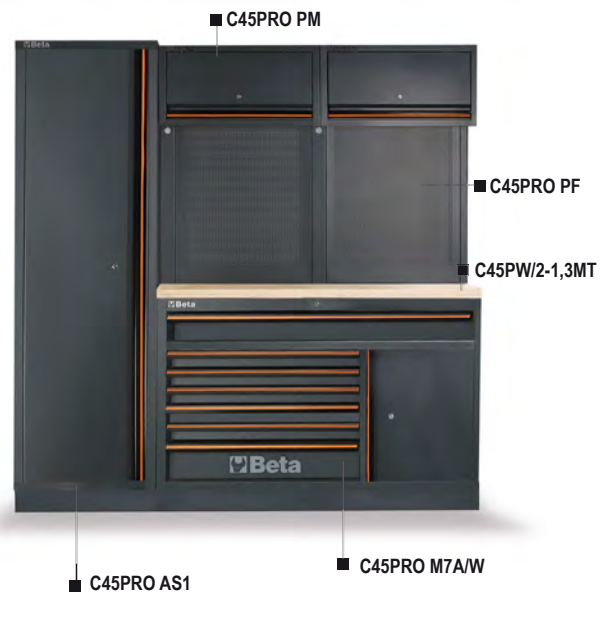

C45PRO CX

Combinaison d'équipements d'atelier C45PRO

Combinaison comprenant :

- Plan de travail en MDF revêtu d'acier inoxydable (C45PX/2-1,3MT)
- Module fixe avec 7 tiroirs (C45PRO M7)
- Module de service fixe (C45PRO MS)
- Armoire à porte unique (C45PRO AS1)
- 2 armoires murales (C45PRO PM)
- 2 panneaux d'outils perforés (C45PRO PF)
- 2 supports muraux, de type large (C45PRO SL)
- 1 support mural, de type étroit (C45PRO SS)

199 kg

C45PRO CX

CHF 4,150.00 1 045000023



C45PRO CW

combinaison d'équipements d'atelier C45PRO avec plan de travail Bois

Combinaison comprenant :

- Plan de travail en bois multicouche (C45PW/2-1.3MT)
- Module fixe avec 7 tiroirs (C45PRO M7)
- Module de service fixe (C45PRO MS)
- Armoire à porte unique (C45PRO AS1)
- 2 armoires murales (C45PRO PM)
- 2 panneaux d'outils perforés (C45PRO PF)
- 2 supports muraux, de type large (C45PRO SL)
- 1 support mural, type étroit (C45PRO SS)

198 kg

C45PRO CW

CHF 3,990.00 1 045000024

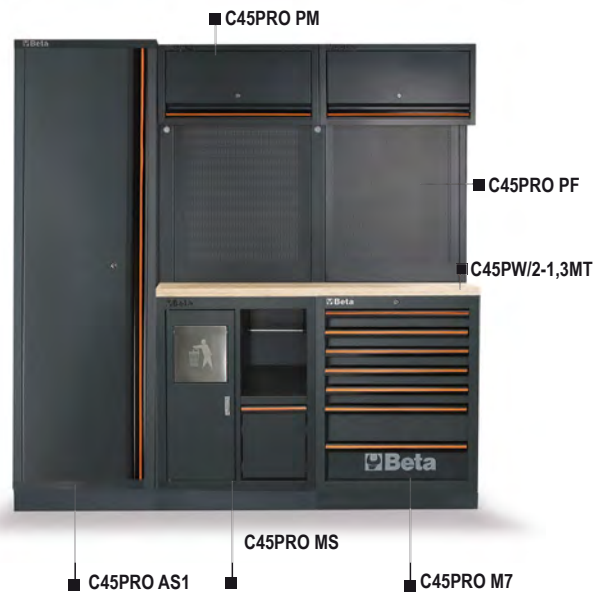

C45PRO BPX-1,3

établis inox 1,3m pour la combinaison d'équipements d'atelier C45PRO

Combinaison comprenant :

- Plan de travail en MDF revêtu d'acier inoxydable (C45PX / 2-1.3MT)
- Module fixe avec 7 tiroirs (C45PRO M7)
- Module fixe avec 5 tiroirs (C45PRO M5)
- 2 panneaux d'outils perforés (C45PRO PF)
- 1 support mural, type large (C45PRO SL)
- 2 supports muraux, de type étroit (C45PRO SS)

140 kg

C45PRO BPX-1,3

CHF 2,780.00 1 045000041



C45PRO BPW-1,3

établis bois 1,3m pour la combinaison d'équipements d'atelier C45PRO

Combinaison comprenant:

- Plan de travail en bois multicolory (C45PW/2-1.3MT)
- Module fixe avec 7 tiroirs (C45PRO M7)
- Module fixe avec 5 tiroirs (C45PRO M5)
- 2 panneaux d'outils perforés (C45PRO PF)
- 1 support mural, type large (C45PRO SL)
- 2 supports muraux, de type étroit (C45PRO SS)

139 kg

C45PRO BPW-1,3

CHF 2,630.00 1 045000051



C45PRO BPX-2,0

établis inox 2,0m pour la combinaison d'équipements d'atelier C45PRO

Combinaison comprenant:

- Plan de travail en MDF revêtu d'acier inoxydable (C45PX / 3-2.0MT)
- Module fixe avec 7 tiroirs (C45PRO M7)
- Module fixe avec 5 tiroirs (C45PRO M5)
- 3 panneaux d'outils perforés (C45PRO PF)
- 2 supports muraux, de type large (C45PRO SL)
- 2 supports muraux, de type étroit (C45PRO SS)

158 kg

C45PRO BPX-2,0

CHF 3,140.00 1 045000042



C45PRO BPW-2,0

établis bois 2,0m pour la combinaison d'équipements d'atelier C45PRO

Combinaison comprenant:

- Plan de travail en bois multicolory (C45PW/3-2,0MT)
- Module fixe avec 7 tiroirs (C45PRO M7)
- Module fixe avec 5 tiroirs (C45PRO M5)
- 3 panneaux d'outils perforés (C45PRO PF)
- 2 supports muraux, de type large (C45PRO SL)
- 2 supports muraux, de type étroit (C45PRO SS)

156 kg

C45PRO BPW-2,0

CHF 2,980.00 1 045000052



C45PRO M7A/X

module fixe avec 7 tiroirs, pour la combinaison d'équipements d'atelier C45PRO

- Plan de travail en MDF revêtu d'acier inoxydable, 1360 mm de long
- 1 tiroir (1248x406 mm) avec glissières à roulement à billes
- 6 tiroirs (782x406 mm) avec glissières à roulement à billes : 5 tiroirs, 65 mm de haut 1 tiroir, 145 mm de haut
- Bases de tiroirs protégées par des tapis en caoutchouc moussé
- Serrure centralisée avant
- Avec pieds réglables verticalement
- Peut être équipé de plateaux thermoformés
- 1 compartiment de rangement avec étagère intermédiaire et porte, dimensions intérieures 504x424x597 mm

81 kg

C45PRO M7A/X **CHF** 2,075.00 1 045000161



h	max
65 mm	25 kg
105 mm	40 kg
145 mm	30 kg

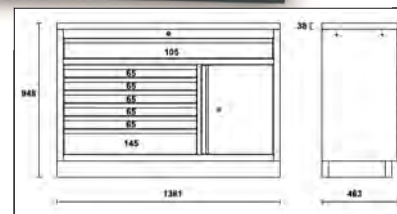

C45PRO M7A/W

module fixe avec 7 tiroirs, pour la combinaison d'équipements d'atelier C45PRO

- Plan de travail en bois multicolé, 1360 mm de long
- 1 tiroir (1248x406 mm) avec glissières à roulement à billes
- 6 tiroirs (782x406 mm) avec glissières à roulement à billes : 5 tiroirs, 65 mm de haut 1 tiroir, 145 mm de haut
- Bases de tiroirs protégées par des tapis en caoutchouc moussé
- Serrure centralisée avant
- Avec pieds réglables verticalement
- Peut être équipé de plateaux thermoformés
- 1 compartiment de rangement avec étagère intermédiaire et porte, dimensions intérieures 504x424x597 mm

80 kg

C45PRO M7A/W **CHF** 1,940.00 1 045000171



h	max
65 mm	25 kg
105 mm	40 kg
145 mm	30 kg

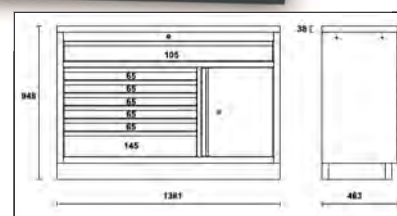

C45PRO MWS/X

Servante mobile Work Station avec 7 tiroirs et bac à déchets intégré

- Plan de travail en MDF revêtu d'acier inoxydable, 1680 mm de long
- 1 tiroir (1248x406 mm) avec glissières à roulement à billes
- 6 tiroirs (782x406 mm) avec glissières à roulement à billes : 5 tiroirs, 65 mm de haut 1 tiroir, 145 mm de haut
- Bases de tiroirs protégées par des tapis en caoutchouc moussé
- Peut être équipée de plateaux thermoformés
- Compartiment de rangement avec étagère intermédiaire et porte, dimensions intérieures 504x424x597 mm
- Bac à déchets intégré
- Porte-papier intégré
- 4 roulettes haute capacité, Ø 150 mm (une avec frein)
- Serrure centralisée à l'avant

126 kg

C45PRO MWS/X **CHF** 2,200.00 1 045000181



h	max
65 mm	25 kg
105 mm	40 kg
145 mm	30 kg

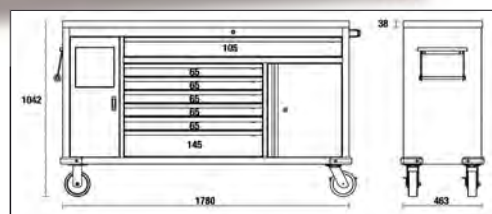

C45PRO MWS/W

Servante mobile Work Station avec 7 tiroirs et bac à déchets intégré

- Plan de travail en bois multicouche, 1680 mm de long
- 1 tiroir (1248x406 mm) avec glissières à roulement à billes
- 6 tiroirs (782x406 mm) avec glissières à roulement à billes :
- 5 tiroirs, 65 mm de haut
- 1 tiroir, 145 mm de haut
- Bases de tiroirs protégées par des tapis en caoutchouc moussé
- Peut être équipée de plateaux thermoformés
- Compartiment de rangement avec étagère intermédiaire et porte, dimensions intérieures 504x424x597 mm
- Bac à déchets intégré
- Porte-papier intégré
- 4 roulettes haute capacité, Ø 150 mm (une avec frein)
- Serrure centralisée à l'avant

📦 122 kg

C45PRO MWS/W CHF 2,145.00 1 045000191



h	max
65 mm	25 kg
105 mm	40 kg
145 mm	30 kg

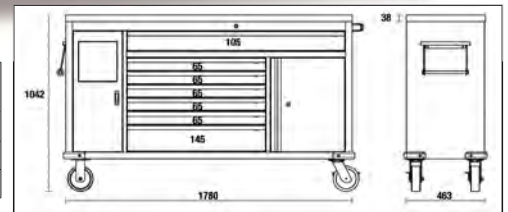

C45PX/1-0,7MT

plan de travail en MDF revêtu d'acier inoxydable, 680x463 mm, pour les établis pour la combinaison d'équipements d'atelier C45PRO

- Épaisseur : 38 mm

📦 6 kg

C45PX/1-0,7MT CHF 267.00 1 045000101



C45PW/1-0,7MT

plan de travail en bois contre-plaqué stratifié, 680x463 mm, pour les établis pour la combinaison d'équipements d'atelier C45PRO

- Épaisseur : 38 mm

📦 6 kg

C45PW/1-0,7MT CHF 157.50 1 045000111



C45PX/2-1,3MT

Plan de travail en MDF revêtu en acier inoxydable, 1360x463 mm, pour ameublement atelier C45PRO

- Epaisseur : 38 mm

📦 21 kg

C45PX/2-1,3MT CHF 427.00 1 045000103



C45PW/2-1,3MT

Plan de travail en Bois, 1360x463 mm, pour ameublement atelier C45PRO

- Epaisseur : 38 mm

📦 20 kg

C45PW/2-1,3MT CHF 272.00 1 045000113



C45PX/3-2,0MT

Plan de travail en MDF revêtu en acier inoxydable , 2040x463 mm, pour ameublement atelier C45PRO

• Epaisseur : 38 mm

31,8 kg

C45PX/3-2,0MT

CHF 572.00 1 045000110



C45PW/3-2,0MT

Plan de travail en Bois , 2040x463 mm, pour ameublement atelier C45PRO

• Epaisseur : 38 mm

30 kg

C45PW/3-2,0MT

CHF 408.00 1 045000120



C45PRO C5

Servante mobile avec 5 tiroirs, pour la combinaison d'équipements d'atelier C45PRO

- 5 tiroirs (532x406 mm) avec glissières à roulement à billes
- 4 roulettes directionnelles, Ø 100 mm (une avec frein)
- Bases de tiroirs protégées par des tapis en caoutchouc moussé
- Serrure centralisée à l'avant
- Peut être équipée de plateaux thermoformés
- Poignées intégrées dans le cadre pour une meilleure facilité de manipulation

46 kg

C45PRO C5

CHF 997.00 1 045000225

h	max
65 mm	25 kg
145 mm	30 kg

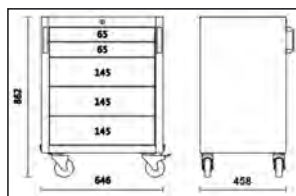
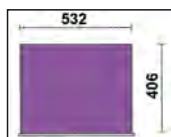

C45PRO C7

servante mobile avec 7 tiroirs, pour la combinaison d'équipements d'atelier C45PRO

- 7 tiroirs (532x406 mm) avec glissières à roulement à billes
- 4 volants, Ø 100 mm (1 avec frein)
- Bases de tiroirs protégées par des tapis en caoutchouc moussé
- Serrure centralisée avant
- Peut être équipé de plateaux thermoformés
- Poignées intégrées dans le cadre pour une meilleure facilité de manipulation

50 kg

C45PRO C7

CHF 1,044.00 1 045000227

h	max
65 mm	25 kg
145 mm	30 kg

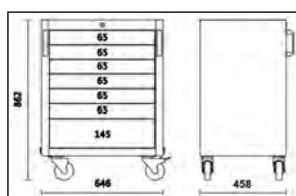
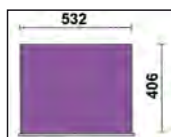

C45PRO M4

module fixe avec 4 tiroirs, pour la combinaison d'équipements d'atelier C45PRO

4 tiroirs (566x406 mm) avec glissières à roulement à billes

- Bases de tiroirs protégées par des tapis en caoutchouc moussé
- Serrure centralisée avant
- Avec pieds réglables verticalement
- Peut être équipé de plateaux thermoformés

📦 45,7 kg

h	max
65 mm	25 kg
145 mm	30 kg
225 mm	30 kg

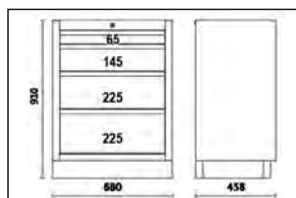
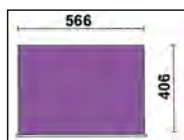

C45PRO M4

CHF 856.00 1 045000234

C45PRO M5

module fixe avec 5 tiroirs, pour la combinaison d'équipements d'atelier C45PRO

- 5 tiroirs (566x406 mm) avec glissières à roulement à billes
- Bases de tiroirs protégées par des tapis en caoutchouc moussé
- Serrure centralisée avant
- Avec pieds réglables verticalement
- Peut être équipé de plateaux thermoformés

📦 49,3 kg

h	max
65 mm	25 kg
145 mm	30 kg

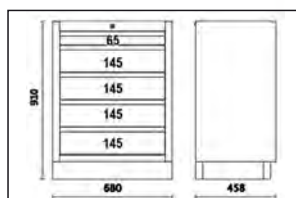
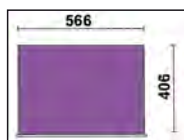

C45PRO M5

CHF 905.00 1 045000235

C45PRO M7

module fixe avec 7 tiroirs, pour la combinaison d'équipements d'atelier C45PRO

- 7 tiroirs (566x406 mm) avec glissières à roulement à billes
- Bases de tiroirs protégées par des tapis en caoutchouc moussé
- Serrure centralisée avant
- Avec pieds réglables verticalement
- Peut être équipé de plateaux thermoformés

📦 54,3 kg

h	max
65 mm	25 kg
145 mm	30 kg

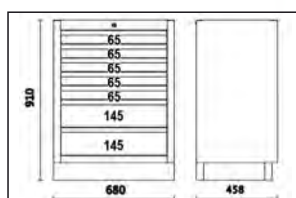
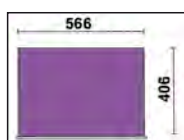

C45PRO M7



CHF 1,004.00 1 045000237

C45PRO M8

Module fixe avec 8 tiroirs, pour la combinaison d'équipements d'atelier C45PRO

- 8 tiroirs (566x406 mm) avec glissières à roulement à billes
- Bases de tiroirs protégées par des tapis en caoutchouc moussé
- Serrure centralisée à l'avant
- Avec pieds réglables verticalement
- Peut être équipé de plateaux thermoformés

📦 56,5 kg

h		 max
65 mm		25 kg
145 mm		30 kg

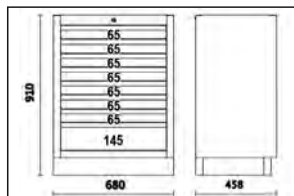
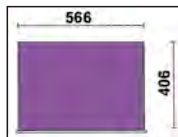

C45PRO M8

CHF 1,092.00 1 045000238

C45PRO MS

module fixe de propreté pour la combinaison d'équipements d'atelier C45PRO

- Bac à déchets intégré
- Compartiment rouleau de papier
- Avec pieds réglables verticalement

📦 37 kg

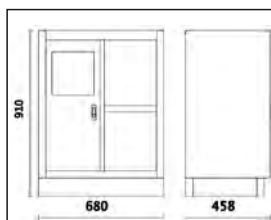

C45PRO MS

CHF 683.00 1 045000239

C45PRO RD

Module fixe de collecte sélective des déchets pour la combinaison d'équipements d'atelier C45PRO

La solution idéale pour la collecte sélective des déchets (verre, papier, plastique...)

- Structure en tôle solide complète avec 4 conteneurs à porte basculante pour collecter les déchets séparément
- Chaque conteneur est équipé de :
 - un panier en plastique amovible, capacité 25 litres
- 4 roues pivotantes Ø 60 mm
- Kit de 4 autocollants colorés inclus dans le packaging
- Équipé de pieds réglables verticalement

📦 80 kg



C45PRO RD/X



C45PRO RD/W

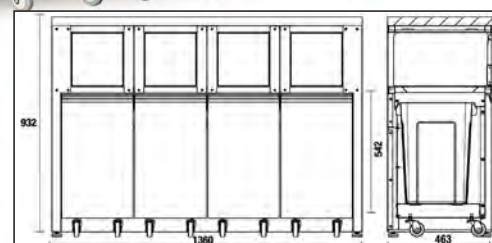

C45PRO RD/X

CHF 2,110.00 1 045000241

C45PRO RD/W

CHF 1,970.00 1 045000240

C45PRO MA

module fixe à deux portes pour la combinaison d'équipements d'atelier C45PRO

- Avec serrure
- Étagère intérieure réglable verticalement
- Dimensions intérieures 670x420 mm
- Avec pieds réglables verticalement

📦 29,4 kg

C45PRO MA

CHF 507.00 1 045000232

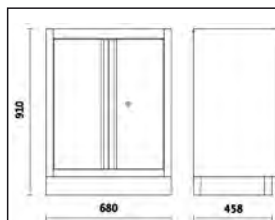

C45PRO M3A

Module fixe avec 3 tiroirs et 2 portes pour la combinaison d'équipements d'atelier C45PRO

- 3 tiroirs (566x406 mm) avec glissières à roulement à billes
- Bases de tiroirs protégées par des tapis en caoutchouc moussé
- Peut être équipé de plateaux thermoformés
- Serrure centralisée à l'avant
- Compartiment de rangement avec double porte et serrure (dimensions intérieures 670x440 mm), avec étagère intermédiaire
- Avec pieds réglables verticalement

📦 40 kg

C45PRO M3A

CHF 875.00 1 045000231

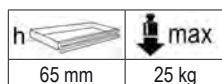

65 mm 25 kg

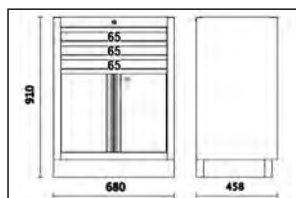
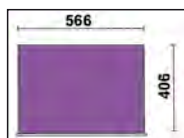

C45PRO ML

module fixe avec évier intégré, pour la combinaison d'équipements d'atelier C45PRO

Caractéristiques techniques :

- Bassin en acier inoxydable.
 - Livré complet avec: 1 mitigeur 1 unité de vidange 1 bouchon d'évier 1 bouchon filtrant 1 distributeur de savon
- Module fixe à deux portes avec serrure:
- Dimensions intérieures utiles 600x603x416 mm
 - Avec pieds réglables verticalement

📦 44 kg

C45PRO ML

CHF 1,375.00 1 045000233

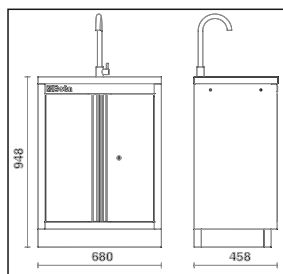

C45PRO ACT

module fixe avec 3 tiroirs et 2 bobines intégrées pour la combinaison d'équipements d'atelier C45PRO

- 3 tiroirs (566x406 mm) avec glissières à roulement à billes
- Bases de tiroirs protégées par des tapis en caoutchouc moussé
- Serrure centralisée avant
- Avec pieds réglables verticalement Livré complet avec:
 - 1 enrouleur de tuyau d'air comprimé ou d'eau froide intégré, Ø 8 mm, longueur 10 m, article 1900S 8x10
 - 1 enrouleur de câble électrique intégré, longueur 15 m, article 1844 15-H05

h	max
65 mm	25 kg
145 mm	30 kg

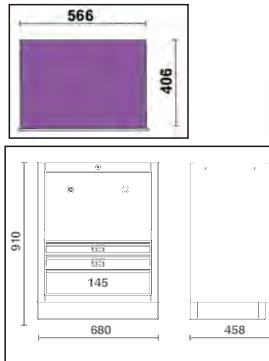

47 kg

C45PRO ACT

CHF 1,300.00 1 045000247

C45PRO TC

Module enrouleur fixe avec 3 tiroirs pour la combinaison d'équipements d'atelier C45PRO, vide

- 3 tiroirs (566x406 mm) avec glissières à roulement à billes
- Bases de tiroirs protégées par des tapis en caoutchouc moussé
- Serrure centralisée à l'avant
- Avec pieds réglables verticalement
- Peut accueillir 2 rouleaux, à choisir parmi les suivants :
 - 2 enrouleurs de tuyaux d'air comprimé ou d'eau froide, Ø 8 mm, longueur 10 m art. 1900S 8x10
 - 2 enrouleurs de câbles électriques, à choisir parmi les suivants : 1843 15-H05, 1844 10-H05, 1844 15-H05, 1844 15-H07, 1845 12-H05, 1846 10-H05, 1846 10-H07 et 1846 15-H05
 - 1 enrouleur de tuyau d'air comprimé ou d'eau froide, Ø 8 mm, longueur 10 m art. 1900S 8x10 et 1 enrouleur de câbles électrique à choisir parmi les articles listés ci-dessus

h	max
65 mm	25 kg
145 mm	30 kg

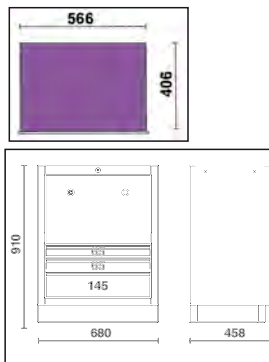

38 kg

C45PRO TC

CHF 796.00 1 045000249

C45PRO T3

Chariot avec 3 étagères, pour la combinaison d'équipements d'atelier C45PRO

- Double possibilité de fixation du plateau central
- Quatre roulettes directionnelles, Ø 100 mm (deux avec freins)
- Capacité de charge statique : 200 kg (répartie sur les 3 étagères)

19,2 kg

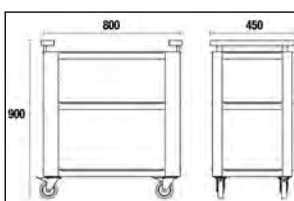

C45PRO T3

CHF 467.00 1 045000250

C45PRO SS

supports muraux latéraux, de type étroit, pour la combinaison d'équipements d'atelier C45PRO

- Dimensions 1420x32.5x30 mm

📦 1,5 kg



C45PRO SS CHF 38.50 1 045000333

C45PRO SL

supports muraux latéraux, de type large, pour la combinaison d'équipements d'atelier C45PRO

- Dimensions 1420x65x30 mm

📦 2 kg



C45PRO SL CHF 51.50 1 045000366

C45PRO PAS

Paroi porte-outils, pour la combinaison d'équipements d'atelier C45PRO

- Volet roulant en aluminium à mouvement vertical avec serrure
- Deux panneaux d'outils perforés amovibles
- Possibilité d'assortiment à le plan de travail de 1,3 mètres

📦 48,8 kg

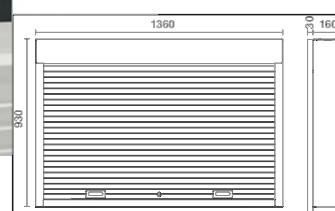

C45PRO PAS CHF 1,260.00 1 045000290

C45PRO PF

panneau d'outils perforé pour la combinaison d'équipements d'atelier C45PRO

- Dimensions 1052x614.5x24 mm

📦 5,3 kg



C45PRO PF CHF 159.50 1 045000313

C45PRO PFE

panneau d'outils perforé pour la combinaison d'équipements d'atelier C45PRO

Dimensions 1052x614,5x24 mm

• Peut être équipé d'une prise de courant (non incluse)

5,3 kg



C45PRO PFE

CHF 151.00 1 045000312

C45PRO CORNER/X

Angle complet autoportant pour la combinaison d'équipements d'atelier C45PRO

- Armoire d'angle suspendue avec ressorts à gaz, facilitant l'ouverture et la fermeture de la porte
- 2 panneaux d'outils perforés (1052x860)
- Plan de travail d'angle en acier inoxydable (860x860 mm)
- Module d'angle inférieur avec grand compartiment de rangement
- Avec pieds réglables verticalement

94 kg

C45PRO CORNER/X

CHF 2,600.00 1 045000401

C45PRO CORNER/W

angle complet autoportant pour la combinaison d'équipements d'atelier C45PRO

- Armoire d'angle suspendue avec serrure et ressorts à gaz, facilitant l'ouverture et la fermeture de la porte
- 2 panneaux d'outils perforés (1052x860 mm)
- Plan de travail d'angle en bois multicouche (860x860 mm)
- Module d'angle inférieur avec grand compartiment de rangement
- Avec pieds réglables verticalement

93 kg

C45PRO CORNER/W

CHF 2,500.00 1 045000411



C45PRO CAI/X

Module d'angle inférieur, pour la combinaison d'équipements d'atelier C45PRO

- Plan de travail d'angle en MDF revêtu d'acier inoxydable (860x860 mm)
- Module fixe d'angle avec grand compartiment de rangement
- Avec pieds réglables verticalement

📦 62 kg



C45PRO CAI/X CHF 1,425.00 1 045000412

C45PRO CAI/W

Module d'angle inférieur, pour la combinaison d'équipements d'atelier C45PRO

- Plan de travail d'angle en bois multicouche (860x860 mm)
- Module fixe d'angle avec grand compartiment de rangement
- Avec pieds réglables verticalement

📦 56 kg



C45PRO CAI/W CHF 1,335.00 1 045000402

C45PRO PM

Armoire murale pour la combinaison d'équipements d'atelier C45PRO

- Longueur armoire murale 680 mm
- Avec ressorts à gaz, facilitant l'ouverture et la fermeture de la porte
- Avec serrure

📦 10 kg

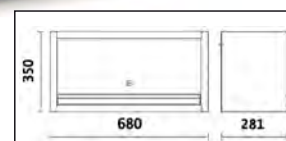

C45PRO PM CHF 293.00 1 045000302

C45PRO PML

Armoire murale longue, pour la combinaison d'équipements d'atelier C45PRO

- Longueur armoire murale : 1360 mm
- Avec ressorts à gaz, facilitant l'ouverture et la fermeture de la porte
- Avec serrure

📦 18 kg

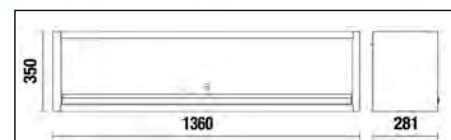

C45PRO PML CHF 525.00 1 045000303

C45PRO AS1

armoire à outils mono-porte en tôle avec support, pour la combinaison d'équipements d'atelier C45PRO

- 4 étagères amovibles et réglables verticalement
- Avec serrure
- Dimensions intérieures 590x430 mm
- Avec pieds réglables verticalement

📦 57,5 kg

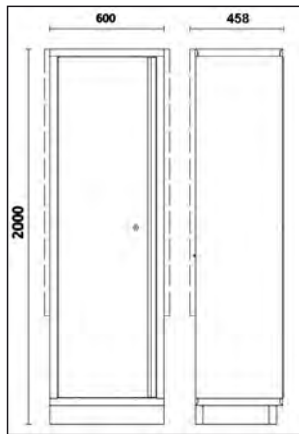

C45PRO AS1 CHF 1,043.00 1 045000451

C45PRO AS2

armoire à outils en tôle à deux portes avec support, pour la combinaison d'équipements d'atelier C45PRO

- 4 étagères amovibles et réglables verticalement
- Avec serrure
- Dimensions intérieures 590x430 mm
- Avec pieds réglables verticalement

📦 80 kg

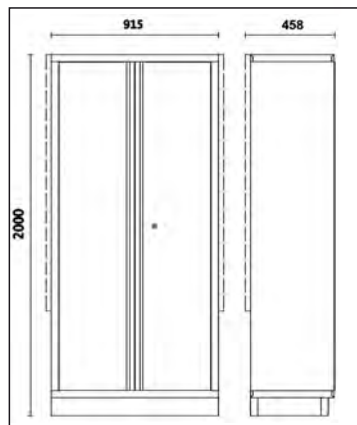

C45PRO AS2 CHF 1,385.00 1 045000481

C45STR

Ruban adhésif coloré, pour la combinaison d'équipements d'atelier C45PRO

- Permet de personnaliser la couleur des embouts horizontaux et verticaux de la combinaison d'équipements d'atelier C45PRO



	L m	CHF	📦	🏠
C45STR-O/2011	30	82.00	1	045000911
C45STR-G/9006	25	74.50	1	045000912
C45STR-R/3000	25	74.50	1	045000913
C45STR-B/5015	25	74.50	1	045000914
C45STR-Y/1023	25	74.50	1	045000915
C45STR-V/6029	25	74.50	1	045000916

ACCESSOIRES RSC55 - C45PRO

C45LMP

Lampe à LED pour ameublement atelier C45PRO - RSC55

- Longueur : 630 mm
- Fixation pratique sous le meuble haut au moyen d'adhésifs
- Interrupteur ON/OFF
- 570 lumens



📦 307 g

C45LMP CHF 163.50 1 045000320

PM/5C

5 bacs de rangement en matière plastique, avec support

- Dimension interne de la cuve 95x120 mm
- adaptable sur les panneaux porte-outils perforés des C45PRO et RSC55



📦 1,8 kg

PM/5C CHF 122.50 1 088880450

PM/6C

6 bacs de rangement en matière plastique, avec support

- Dimension interne de la cuve 80x60 mm
- adaptable sur les panneaux porte-outils perforés des C45PRO et RSC55



📦 970 g

PM/6C CHF 95.50 1 088880440

CP

Panier mural porte-flacons en acier

- Adaptable aux panneaux muraux porte-outils

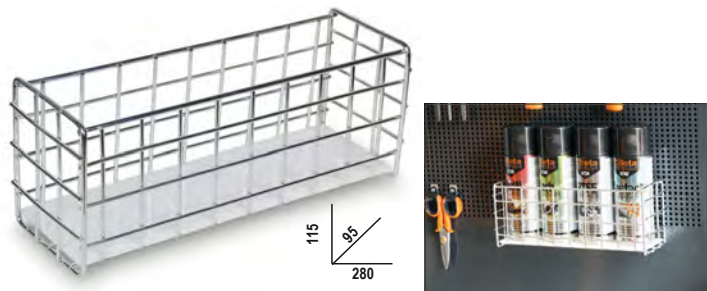

CP CHF 129.00 1 088880470

SPC

support mural d'ordinateur

- Correspond aux systèmes muraux d'outils RSC55 et C45PRO
- Dimensions 398x243x138 mm



SPC CHF 104.00 1 088880480

SERVANTES MOBILES D'ATELIER ET COFFRES

OUTILS EN VRAC

MODULES

			N° Pièces	SERVANTES MOBILES D'ATELIER ET COFFRES														
				RSC22	RSC23	RSC23C	RSC23T	RSC24/5	RSC24/6	RSC24/7	RSC24A/7	RSC24/8	RSC24A/8	RSC24AXL/9	C25	C27S	RSC28	C30M
sans supports	5902MT	Chantier et agricoles	106	☐ 477	☐ 477	☐ 477												
	5902MT/AS	Chantier et agricoles	99	☐ 478	☐ 478	☐ 478												
	5902VI	Industrie	107	☐ 443	☐ 443		☐ 443							☐ 443	☐ 443			
	5904VG/3	Automobile	132					☐ 481	☐ 481	☐ 481	☐ 481							
	5905VG/1	Automobile	94											☐ 484				
	5905VG/2	Automobile	118											☐ 485				
	5910VI/3	Industrie	297															☐ 447
	5954VG	Automobile	138															
	5954VI	Industrie	133															
	5957U-P	Industrie	133															
5957VG	Automobile	174																
5957VI	Industrie	162																
5958U	Industrie	85																
modules soft spécifiques	5904VG/2M	Automobile	170				☐ 479	☐ 479	☐ 479	☐ 479	☐ 479	☐ 479					☐ 479	
	5904VU/1M	Industrie	90				☐ 452	☐ 452	☐ 452	☐ 452	☐ 452	☐ 452					☐ 452	
	5904VU/2M	Industrie	144				☐ 453	☐ 453	☐ 453	☐ 453	☐ 453	☐ 453					☐ 453	
	5927VU/M	Industrie	108	☐ 463	☐ 463	☐ 463									☐ 463			
	5935ET/1MB	Microtechnique	96															
	5935VG/1MB	Automobile	98															
	5935VI/2MB	Industrie	133															
	5945VUM	Industrie	231															
	5988H/7M	Réparation motos et vélos	333									☐ 469	☐ 469				☐ 469	
	5988L/4M	Automobile	273					☐ 470	☐ 470	☐ 470	☐ 470	☐ 470						
	5988U6/M	Industrie	214							☐ 471	☐ 471	☐ 471					☐ 471	
	5988U/7M	Industrie	215				☐ 459	☐ 459	☐ 459	☐ 459	☐ 459	☐ 459					☐ 459	
	5988VHB-MQ	Microtechnique	66				☐ 475	☐ 475	☐ 475	☐ 475	☐ 475	☐ 475					☐ 475	
	plateaux thermoformés	5904VI/1T	Industrie	98				☐ 443	☐ 443	☐ 443	☐ 443	☐ 443	☐ 443					☐ 443
		5904VI/2T	Industrie	153				☐ 444			☐ 444	☐ 444	☐ 444					☐ 444
		5904VI/3T	Industrie	142								☐ 445	☐ 445					☐ 445
		5904VG/2T	Automobile	99				☐ 480	☐ 480	☐ 480	☐ 480	☐ 480	☐ 480					☐ 480
		5904VG/3T	Automobile	102				☐ 482	☐ 482	☐ 482	☐ 482	☐ 482	☐ 482					☐ 482
		5904VG/5T	Automobile	153				☐ 483		☐ 483	☐ 483	☐ 483	☐ 483					☐ 483
5904VU/2T		Industrie	104				☐ 454	☐ 454	☐ 454	☐ 454	☐ 454	☐ 454					☐ 454	
5904VU/3T		Industrie	146				☐ 455	☐ 455	☐ 455	☐ 455	☐ 455	☐ 455					☐ 455	
5904VU/4T		Industrie	197				☐ 456	☐ 456	☐ 456	☐ 456	☐ 456	☐ 456						
5908VG/2T		Automobile	214														☐ 486	
5908VI/2T		Industrie	232								☐ 446	☐ 446					☐ 446	
5908VU/2T		Industrie	161				☐ 457		☐ 457	☐ 457	☐ 457	☐ 457					☐ 457	
5910VG/3T		Automobile	202															☐ 487
5910VI/3T		Industrie	261															☐ 448
5938U/2T		Industrie	210															

SERVANTES MOBILES D'ATELIER ET COFFRES

OUTILS EN VRAC

MODULES

		N° Pièces	C35	C38	C39MD C39SM	C39T	C45PRO	RSC51	C54S RSC55C	RSC55	RSC55PS RSC55PSE	C57SA C57SD	C57SB C57SP	C58P C45PRO PAS	C59A C59C	C59B
sans supports	5902MT	Chantier et agricoles	106			☐ 477										
	5902MT/AS	Chantier et agricoles	99			☐ 478										
	5902VI	Industrie	107													
	5904VG/3	Automobile	132							☐ 482					☐ 482	☐ 482
	5905VG/1	Automobile	94													
	5905VG/2	Automobile	118													
	5910VI/3	Industrie	297													
	5954VG	Automobile	138						☐ 491							
	5954VI	Industrie	133						☐ 451	☐ 451						
	5957U-P	Industrie	133								☐ 465	☐ 465				
	5957VG	Automobile	174								☐ 492	☐ 492				
	5957VI	Industrie	162									☐ 450				
5958U	Industrie	85				☐ 466			☐ 466	☐ 466			☐ 466			
modules soft spécifiques	5904VG/2M	Automobile	170		☐ 479	☐ 479				☐ 479					☐ 479	☐ 479
	5904VU/1M	Industrie	90		☐ 452	☐ 452		☐ 452		☐ 452					☐ 452	☐ 452
	5904VU/2M	Industrie	144		☐ 453	☐ 453				☐ 453					☐ 453	☐ 453
	5927VU/M	Industrie	108													
	5935ET/1MB	Microtechnique	96	☐ 472												
	5935VG/1MB	Automobile	98	☐ 488												
	5935VI/2MB	Industrie	133	☐ 449												
	5945VUM	Industrie	231		☐ 490		☐ 490									
	5988H/7M	Réparation motos et vélos	333								☐ 469					☐ 469
	5988L/4M	Automobile	273		☐ 470	☐ 470					☐ 470				☐ 470	☐ 470
	5988U6/M	Industrie	214		☐ 471						☐ 471					☐ 471
	5988U/7M	Industrie	215		☐ 459						☐ 459				☐ 459	☐ 459
	5988VHB-MQ	Microtechnique	66		☐ 475	☐ 475		☐ 475			☐ 475				☐ 475	☐ 475
	5904VI/1T	Industrie	98		☐ 443	☐ 443		☐ 443			☐ 443				☐ 443	☐ 443
	5904VI/2T	Industrie	153		☐ 444						☐ 444				☐ 444	☐ 444
	5904VI/3T	Industrie	142		☐ 445						☐ 445					☐ 445
	5904VG/2T	Automobile	99		☐ 480	☐ 480		☐ 480			☐ 480				☐ 480	☐ 480
	5904VG/3T	Automobile	102		☐ 482	☐ 482					☐ 482				☐ 482	☐ 482
	5904VG/5T	Automobile	153		☐ 483						☐ 483				☐ 483	☐ 483
	5904VU/2T	Industrie	104		☐ 454	☐ 454					☐ 454				☐ 454	☐ 454
5904VU/3T	Industrie	146		☐ 455	☐ 455					☐ 455				☐ 455	☐ 455	
5904VU/4T	Industrie	197		☐ 456	☐ 456					☐ 456				☐ 456	☐ 456	
5908VG/2T	Automobile	214														
5908VI/2T	Industrie	232													☐ 446	
5908VU/2T	Industrie	161		☐ 457						☐ 457				☐ 457	☐ 457	
5910VG/3T	Automobile	202														
5910VI/3T	Industrie	261														
5938U/2T	Industrie	210		☐ 464												

5902VI

Composition de 107 outils

► Maintenance industrielle

Quantité/Description

Quantité/Description	Réf. Beta
6 chasse-goupilles Ø 2 - 3 - 4 - 5 - 6 - 8 mm	31
1 pointeau Ø 3 mm	32
1 burins nervurés 200 mm	35
26 clé mixte 6÷32 mm	42/S26
12 clés à fourches 6x7 - 8x9 - 10x11 - 12x13 - 14x15 - 16x17 - 18x19 - 20x22 - 21x23 - 24x26 - 25x28 - 30x32 mm	55/S12
9 clés mâles 6 pans coudées Ø 1,5 - 2 - 2,5 - 3 - 4 - 5 - 6 - 8 - 10 mm	96N/SC9
1 Clé à molette à ouverture graduée, chromée 300 mm	111E
13 douilles 6 pans 1/2" sur rail Ø 10÷22 mm	920A/SB13
1 rallonge - 1/2" 125 mm	920/21
1 rallonge - 1/2" 255 mm	920/22
1 cardan 1/2"	920/25
1 poignée coulissante 1/2"	920/42
1 cliquet réversible 1/2" Ⓢ	920/55
1 Pince multiprise entrepassée 250 mm	1048N
1 pince - étau à becs droits 240 mm	1052
1 pince coupante diagonale à faible effort de coupe, branchées gainées confort bi-matières, finition industrielle 160 mm	1084GBM
1 cisaille bichantourneuse coupe droite 250 mm	1122
1 ciseaux d'électricien	1128BMX
1 pince universelle, branches gainées confort bi-matières, modèle grande capacité, finition industrielle 180 mm	1150GBM
1 pince à becs demi-ronds longs striés, branches gainées confort bi-matières, finition industrielle 160 mm	1166GBM
8 tournevis pour vis à fente ● 2,5x50 - 3x75 - 3,5x100 - 4x125 - 5,5x125 - 6,5x150 - 8x200 - 10x200 mm	1260
4 tournevis pour vis Phillips® Ⓢ PH0x60 - PH1x80 - PH2x100 - PH3x150 mm	1262
1 marteau de mécanicien 500 g	1370
1 massette sans rebond Ø 40 mm	1392
1 pointe à tracer en carbure	1688A
1 mètre à ruban 5 m	1692
1 jauge d'épaisseur	1708/20
5 limes demi-douces 200 mm	1719BMA...S5
1 monture de scie à métaux	1726BM
1 Burette tôle 300 cc	1751N
1 cutter à lame sécable 18 mm avec lames	1771BM
1 lampe magnétique articulée à LEDs haute luminosité, en aluminium anodisé renforcé, jusqu'à 500 Lumens	1837F



CHF

5902VI 2,130.00 059021060

Composition conseillée avec RSC22 - RSC23 - RSC23T - C25 - C27S

5904VI/1T

Composition de 98 outils en plateaux thermoformés rigides en ABS

► Maintenance industrielle

Quantité/Description

Quantité/Description	Réf. Beta	TR
19 douilles 6 pans avec carré conducteur femelle 1/2" Ø 10÷24 - 26 - 27 - 30 - 32 mm	920A	T80
5 douilles tournevis pour vis 6 pans creux carré femelle 1/2" Ø 5 - 6 - 8 - 10 - 12 mm	920ME	T80
1 rallonge - 1/2" 125 mm	920/21	T80
1 rallonge - 1/2" 255 mm	920/22	T80
1 cardan 1/2"	920/25	T80
1 poignée coulissante 1/2"	920/42	T80
1 cliquet réversible 1/2" Ⓢ	920/55	T80
16 clés mixtes 6÷21 mm	42	T05
5 clés mixtes 22-24-27-30-32 mm	42	T06
1 Pince multiprise entrepassée 250 mm	1048N	T153
1 pince - étau à becs droits 240 mm	1052	T153
1 Pince coupante diagonale à faible effort de coupe 160 mm	1084	T138
1 pince à becs demi-ronds longs 180 mm	1150	T138
1 Pince à becs demi-ronds longs 160 mm	1166	T138
1 pinces pour circlips intérieurs à becs droits Ø 180 mm	1032	T145
1 pinces pour circlips intérieurs à becs coudés Ø 170 mm	1034	T145
1 pinces pour circlips extérieurs à becs droits ● 175 mm	1036	T145
1 pinces pour circlips extérieurs à becs coudés ● 175 mm	1038	T145
2 burins nervurés 100 - 200 mm	35	T234
5 limes demi-douces 200 mm	1719BMA8/S5	T236
1 marteau de mécanicien 300 g	1370	T234
1 marteau de mécanicien Ø 35 mm	1390	T234
8 clés à fourches 6x7 - 8x9 - 10x11 - 12x13 - 14x15 - 16x17 - 18x19 - 20x22 mm	55	T33
9 clés mâles 6 pans coudées Ø 1,5 - 2 - 2,5 - 3 - 4 - 5 - 6 - 8 - 10 mm	96/SC9	T33
4 tournevis pour vis à fente ● 3x75 - 4x100 - 5,5x150 - 6,5x150 mm	1260	T208
3 tournevis pour vis Phillips® Ⓢ PH0x60 - PH1x80 - PH2x100 mm	1262	T208
6 clés mâles 6 pans en T Ø 2,5 - 3 - 4 - 5 - 6 - 8 mm	951	T68



T80 T05 T06



T153 T138 T145 T236



T234 T33 T208 T68

CHF

5904VI/1T 1,940.00 059041161

Composition conseillée avec RSC24 - RSC24A - RSC24AXL - C37 - C39 à 6 - 7 - 8 tiroirs
RSC23T - C39T - RSC24L - RSC24L-CAB - C59 - C55 - RSC28 - C39MD - C39SM

5904VI/2T

Composition de 153 outils en plateaux thermoformés rigides en ABS

► Maintenance industrielle

Quantité/Description

- 16 clés mixtes 6÷21 mm
- 5 clés mixtes 22 - 24 - 27 - 30 - 32 mm
- 5 chasse-goupilles Ø 2 - 3 - 4 - 5 - 6 mm
- 1 pointeau Ø 4 mm
- 12 clés à fourches 6x7 - 8x9 - 10x11 - 12x13 - 14x15 - 16x17
18x19 - 20x22 - 21x23 - 24x26 - 27x29 - 30x32 mm
- 9 clés mâles 6 pans coudées ○ 1,5 - 2 - 2,5 - 3 - 4 - 5 - 6 - 8 - 10 mm
- 7 clés polygonales contre - coudées 6÷29 mm
- 19 douilles 6 pans avec carré conducteur femelle 1/2" ○ 10÷24 - 26 - 27 - 30 - 32 mm
- 1 rallonge - 1/2" 125 mm
- 1 rallonge - 1/2" 255 mm
- 1 cardan 1/2"
- 1 poignée coulissante 1/2"
- 1 cliquet réversible 1/2" ⊕
- 13 douilles 6 pans avec carré conducteur femelle 1/4" ○ 4÷14 mm
- 6 douilles tournevis pour vis 6 pans creux carré femelle 1/4" ○ 2,5÷8 mm
- 1 rallonge - 1/4" 50 mm
- 1 rallonge - 1/4" 150 mm
- 1 cardan avec carrés mâle et femelle 1/4"
- 1 poignée emmanchée avec carré mâle 1/4"
- 1 poignée coulissante avec carré mâle 1/4"
- 1 cliquet réversible avec carré mâle 1/4" ⊕
- 9 tournevis pour vis à fente ● 3x75 - 3x100 - 4x100 - 4x150 - 5,5x100 - 5,5x150 - 6,5x150 - 8x150 - 10x200 mm
- 2 tournevis à lame courte pour vis à fente ● 4x30 - 6,5x30 mm
- 7 tournevis pour vis Phillips® ⊕ PH0x60 - PH0x100 - PH1x80 - PH1x120 - PH2x100 - PH2x150 - PH3x150 mm
- 2 tournevis à lame courte pour vis Phillips® ⊕ PH1x30 - PH2x30 mm
- 1 Pince multiprise entrecroisée 250 mm
- 1 pince - étau à becs droits 240 mm
- 1 Pince coupante diagonale à faible effort de coupe ≲ 160 mm
- 1 Pince à becs demi-ronds longs ● 160 mm
- 1 pince à becs demi-ronds longs ≡ 180 mm
- 1 pinces pour circlips intérieurs à becs droits ○ 180 mm
- 1 pinces pour circlips intérieurs à becs coudés ○ 170 mm
- 1 pinces pour circlips extérieurs à becs droits ● 175 mm
- 1 pinces pour circlips extérieurs à becs coudés ● 175 mm
- 6 clés mâles 6 pans en T ○ 2,5 - 3 - 4 - 5 - 6 - 8 mm
- 5 limes demi-douces 200 mm
- 2 burins nervurés 100 - 200 mm
- 1 marteau de mécanicien 300 g
- 1 marteau de mécanicien Ø 35 mm
- 1 pince à riveter
- 100 rivets en aluminium 2,9x6 mm
- 100 rivets en aluminium 3,2x8 mm
- 100 rivets en aluminium 3,8x10 mm
- 100 rivets en aluminium 4x12 mm
- 100 rivets en aluminium 4,8x12 mm
- 1 mètre à ruban
- 1 mini - monture de scie à métaux
- 1 burette plastique
- 1 cutter à lame sécable 18 mm avec lames

Réf. Beta	TR
42	T05
42	T06
31	T31
32	T31
55	T31
96N/SC9	T31
90	T40
920A	T83
920/21	T83
920/22	T83
920/25	T83
920/42	T83
920/55	T83
900	T91
900ME	T91
900/20	T91
900/21	T91
900/25	T91
900BG/30	T91
900/42	T91
900/55	T91
1260	T167
1260N	T167
1262	T168
1262N	T168
1048N	T153
1052	T153
1084	T138
1166	T138
1150	T138
1032	T145
1034	T145
1036	T145
1038	T145
951	T68
1719BMA8/S5	T236
35	T234
1370	T234
1390	T234
1741B	T281
1741RV...K	T281
1741RV...K	T281
1741RV...K	T281
1741RV...K	T281
1741RV...K	T281
1692	T289
1725CR	T289
1755	T289
1771	T289

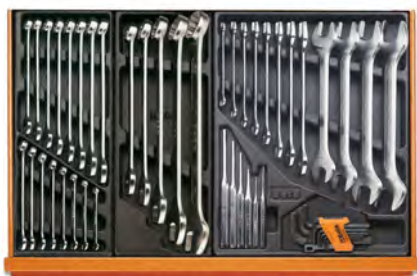

T05 T06 T31



T40 T83 T91



T167 T168



T153 T138 T145 T68



T236 T234 T281 T289

CHF

5904VI/2T

2,720.00 059041164

Composition conseillée avec RSC24 à 7 - 8 tiroirs - RSC24A à 7 - 8 tiroirs - RSC24AXL - C37 à 7 - 8 tiroirs - C39 à 7 - 8 tiroirs
RSC24L - RSC24L-CAB - C59 - C55 - RSC23T - RSC28 - C39MO - C39SM

5904VI/3T

Composition de 142 outils en plateaux thermoformés rigides en ABS

► Maintenance industrielle

Quantité/Description

- 16 clés mixtes 6+21 mm
- 5 clés mixtes 22 - 24 - 27 - 30 - 32 mm
- 5 chasse-goupilles Ø 2 - 3 - 4 - 5 - 6 mm
- 1 pointe Ø 4 mm
- 12 clés à fourches 6x7 - 8x9 - 10x11 - 12x13 - 14x15 - 16x17 - 18x19 - 20x22 - 21x23 - 24x26 - 27x29 - 30x32 mm
- 9 clés mâles 6 pans coudées ○ 1,5 - 2 - 2,5 - 3 - 4 - 5 - 6 - 8 - 10 mm
- 9 tournevis pour vis à fente ● 3x75 - 3,5x100 - 4x100 - 4x150 - 5,5x100 - 5,5x150 - 6,5x150 - 8x150 - 10x200 mm
- 2 tournevis à lame courte pour vis à fente ● 4x30 - 6,5x30 mm
- 6 tournevis pour vis Phillips® ● PH0x60 - PH0x100 - PH1x80 - PH1x120 - PH2x100 - PH2x150 mm
- 7 tournevis pour vis Torx® ○ T6-T7-T8-T9-T10-T15-T20
- 5 douilles tournevis pour vis 6 pans creux carré femelle 1/2" ○ 5 - 6 - 8 - 10 - 12 mm
- 1 rallonge - 1/2" 125 mm
- 1 rallonge - 1/2" 255 mm
- 1 cardan 1/2"
- 1 poignée coulissante 1/2"
- 1 cliquet réversible 1/2" Ⓞ
- 19 douilles 6 pans avec carré conducteur femelle 1/2" ○ 10+24 - 26 - 27 - 30 - 32 mm
- 8 Clé en tube droite 12 pans 6x7 - 8x9 - 10x11 - 12x13 - 14x15 - 16x17 - 18x19 - 20x22 mm
- 1 broches pour articles 930 - 935
- 1 broches pour articles 930 - 935
- 6 clés mâles 6 pans en T ○ 2,5 - 3 - 4 - 5 - 6 - 8 mm
- 1 pince à becs demi-ronds longs = 180 mm
- 1 Pince à becs demi-ronds longs ● 160 mm
- 1 Pince coupante diagonale à faible effort de coupe ≤ 160 mm
- 1 Pince multiprise entrepassée 250 mm
- 1 pince - étau à becs droits 240 mm
- 1 pinces pour circlips intérieurs à becs droits ○ 180 mm
- 1 pinces pour circlips intérieurs à becs coudés ○ 170 mm
- 1 pinces pour circlips extérieurs à becs droits ● 175 mm
- 1 pinces pour circlips extérieurs à becs coudés ● 175 mm
- 1 pinces pour circlips intérieurs à becs droits ○ 140 mm
- 1 pinces pour circlips intérieurs à becs coudés ○ 225 mm
- 1 pinces pour circlips extérieurs à becs droits ● 140 mm
- 1 pinces pour circlips extérieurs à becs coudés ● 225 mm
- 1 marteau de mécanicien 400 g
- 1 marteau de mécanicien Ø 35 mm
- 1 limes demi-douces 200 mm
- 1 limes demi-douces 200 mm
- 1 limes demi-douces 200 mm
- 1 Pied à coulisse à affichage digital
- 1 régle flexible 300 mm
- 1 Mètre à ruban 5 m
- 1 pince à riveter 250 mm
- 100 rivets en aluminium 2,9x6 mm
- 100 rivets en aluminium 3,2x8 mm
- 100 rivets en aluminium 3,8x10 mm
- 100 rivets en aluminium 4x12 mm
- 100 rivets en aluminium 4,8x12 mm
- 1 cisaille type américain coupe droite 250 mm
- 1 ciseaux d'électricien
- 1 monture de scie à métaux
- (5) lames de scies
- 1 Burette plastique sous pression 200 cc
- 1 bac de rangement

Réf. Beta	TR
42	T05
42	T06
31	T31
32	T31
55	T31
96N/SC9	T31
1260	T167
1260N	T167
1262	T202
1267TX	T205
920ME	T80
920/21	T80
920/22	T80
920/25	T80
920/42	T80
920/55	T80
920A	T80
930	T73
940/1	T73
940/2	T73
951	T68
1150BM	T137
1166BM	T137
1084BM	T137
1048N	T153
1052	T153
1032	T145
1034	T145
1036	T145
1038	T145
1032	T146
1034	T146
1036	T146
1038	T146
1370	T231
1390	T231
1719BMA8/T	T231
1719BMA8/P	T231
1719BMA8/M	T231
1651DGT	T297
1682	T297
1691BM	T297
1741B	T281
1741RV..K	T281
1741RV..K	T281
1741RV..K	T281
1741RV..K	T281
1741RV..K	T281
1112	T285
1128BM	T285
1726	T285
1728BM	T285
1753	T285
VP6	VP6



T05 T06 T31



T167 T202 T205



T80 T73 T68



T137 T153 T145 T146



T231 T297 T281



T285 VP6

CHF

5904VI/3T 3,150.00 059041168

Composition conseillée avec RSC24 à 8 tiroirs - RSC24/A à 8 tiroirs - C37 à 8 tiroirs - C39 à 8 tiroirs
RSC24AXL - RSC28 - C39MO - C39SM - C55 - C59B

5908VI/2T

Composition de 232 outils en plateaux thermoformés rigides en ABS

► Maintenance industrielle

Quantité/Description

- 5 douilles tournevis pour vis 6 pans creux carré femelle 1/2" \odot 5 - 6 - 8 - 10 - 12 mm
- 1 rallonge - 1/2" 125 mm
- 1 rallonge - 1/2" 255 mm
- 1 cardan 1/2"
- 1 poignée coulissante 1/2"
- 1 cliquet réversible 1/2" \oplus
- 19 douilles 6 pans avec carré conducteur femelle 1/2" \odot 10+24 - 26 - 27 - 30 - 32 mm
- 16 clés mixtes 6÷21 mm
- 5 clés mixtes 22 - 24 - 27 - 30 - 32 mm
- 13 douilles 6 pans avec carré conducteur femelle 1/4" \odot 4÷14 mm
- 6 douilles tournevis pour vis 6 pans creux carré femelle 1/4" \odot 2,5 - 3 - 4 - 5 - 6 - 8 mm
- 1 rallonge - 1/4" 50 mm
- 1 rallonge - 1/4" 150 mm
- 1 poignée emmanchée avec carré mâle 1/4"
- 1 cardan avec carrés mâle et femelle 1/4"
- 1 poignée coulissante avec carré mâle 1/4"
- 1 cliquet réversible avec carré mâle 1/4" \oplus
- 6 clés mâles 6 pans en T \odot 2,5 - 3 - 4 - 5 - 6 - 8 mm
- 7 clés polygonales contre - coudées 6x7-8x9-10x11-12x13-14x15-16x17-18x19 mm
- 5 clés polygonales contre - coudées 20x22 - 21x23 - 24x26 - 25x28 - 27x29 mm
- 7 tournevis pour vis à fente \bullet 2,5x50 - 3x75 - 3,5x100 - 4x125
5,5x100 - 5,5x150 - 6,5x150 mm
- 6 tournevis pour vis Phillips® \oplus PH0x60 - PH0x100 - PH1x80
PH1x120 - PH2x100 - PH2x150 mm
- 3 tournevis pour vis à fente \bullet 8x200 - 10x150 - 10x200 mm
- 2 tournevis à lame courte pour vis à fente \bullet 4x30 - 6,5x30 mm
- 2 tournevis pour vis Phillips® \oplus PH3x150 - PH4x200 mm
- 2 tournevis à lame courte pour vis Phillips® \oplus PH1x30 - PH2x30 mm
- 2 burins nervurés 100 - 200 mm
- 1 marteau de mécanicien 300 g
- 1 marteau de mécanicien \varnothing 35 mm
- 1 pince à riveter 250 mm
- 100 rivets en aluminium 2,9x6 mm
- 100 rivets en aluminium 3,2x8 mm
- 100 rivets en aluminium 3,8x10 mm
- 100 rivets en aluminium 4x12 mm
- 100 rivets en aluminium 4,8x12 mm
- 1 Pince multiprise entrepassée 250 mm
- 1 pince - étau à becs droits 240 mm
- 5 limes demi-douces 200 mm
- 1 pinces pour circlips intérieurs à becs droits \odot 180 mm
- 1 pinces pour circlips intérieurs à becs coudés \odot 170 mm
- 1 pinces pour circlips extérieurs à becs droits \bullet 175 mm
- 1 pinces pour circlips extérieurs à becs coudés \bullet 175 mm
- 1 pince à becs demi-ronds longs \equiv 180 mm
- 1 Pince à becs demi-ronds longs \bullet 160 mm
- 1 Pince coupante diagonale à faible effort de coupe \leq 160 mm
- 5 chasse-goupilles \varnothing 2 - 3 - 4 - 5 - 6 mm
- 1 pointeau \varnothing 4 mm
- 12 clés à fourches 6x7 - 8x9 - 10x11 - 12x13 - 14x15 - 16x17
18x19 - 20x22 - 21x23 - 24x26 - 27x29 - 30x32 mm
- 9 clés mâles 6 pans coudées \odot 1,5 - 2 - 2,5 - 3 - 4 - 5 - 6 - 8 - 10 mm
- 1 cisaille type américain coupe droite 250 mm
- 1 ciseaux d'électricien
- 1 monture de scie à métaux
- 5 lames de scies
- 1 Burette plastique sous pression 200 cc
- 1 bac de rangement
- 1 tourne - à - gauche extensible M3÷M12
- 1 tourne - à - gauche extensible M5÷M21
- 1 porte - outils à cliquet réversible 2,0÷5,0 mm (M3÷M8)
- 1 porte - outils à cliquet réversible 4,6÷8,0 mm (M5÷M12)
- 1 porte - filières 25,4 mm
- 1 porte - filières 38,1 mm
- 1 jauge de filetage 0,25÷6 W 62÷4x1"
- 26 tarauds à main, pas gros, filetage métrique M3 - 4 - 5 - 6 - 7 - 8 - 9 - 10 - 12 - 14 - 16 - 18 - 20
- 14 tarauds à main, pas fin, filetage métrique M6x0,75 - M8x1 - M10x1,25
M12x1,5 - M14x1,5 - M16x1,5 - M18x1,5
- 7 filières rondes, pas gros, filetage métrique M3 - 4 - 5 - 6 - 7 - 8 - 9
- 6 filières rondes, pas gros, filetage métrique M10 - 12 - 14 - 16 - 18 - 20
- 2 filières rondes, pas fin, filetage métrique M6x0,75 - M8x0,75
- 5 filières rondes, pas fin, filetage métrique M10x1,25 - M12x1,5 - M14x1,5 - M16x1,5 - M18x1,5

Réf. Beta	TR
920ME	T80
920/21	T80
920/22	T80
920/25	T80
920/42	T80
920/55	T80
920A	T80
42	T05
42	T06
900	T91
900ME	T91
900/20	T91
900/21	T91
900BG/30	T91
900/25	T91
900/42	T91
900/55	T91
951	T68
90	T40
90	T41
1260	T199
1262	T202
1260	T201
1260N	T201
1262	T204
1262N	T204
35	T234
1370	T234
1390	T234
1741B	T281
1741RV...K	T281
1741RV...K	T281
1741RV...K	T281
1741RV...K	T281
1741RV...K	T281
1048N	T153
1052	T153
1719BMA...S5	T236
1032	T145
1034	T145
1036	T145
1038	T145
1150BM	T137
1166BM	T137
1084BM	T137
31	T31
32	T31
55	T31
96N/SC9	T31
1112	T285
1128BM	T285
1726	T285
1728BM	T285
1753	T285
VP5	VP5
435/1,5	T273
435/3	T273
436/1	T273
436/2	T273
444/1	T273
444/2	T273
1707	T273
430	T270
433	T270
440	T270
440A	T270
441	T270
441A	T270

CHF

5908VI/2T

4,180.00 059081105

Composition conseillée avec RSC28 - RSC24AXL à 8-tiroirs, RSC24A à 8-tiroirs, RSC24 à 8-tiroirs, C37 à 8-tiroirs, C39 à 8-tiroirs



5910VI/3

Composition de 297 outils

► Maintenance industrielle

Quantité/Description	Réf. Beta
6 Ø 2 - 3 - 4 - 5 - 6 - 8 mm	31/B6N
1 pointeau Ø 4 mm	32
2 burins nervurés 125 - 250 mm	35
1 bédane nervurée 200 mm	37
30 clés mixtes 6-7-8-9-10-11-12-13-14-15-16-17-18-19-20-21-22-23-24-25-26-27-28-29-30-32-35-36-38-41 mm	42
14 clés à fourches 6x7 - 8x9 - 10x11 - 12x13 - 14x15 - 16x17 - 18x19 - 20x22 - 21x23 - 24x26 - 25x28 - 27x29 - 30x32 - 36x41 mm	55
13 clés polygonales contre - coudées 6x7+30x32 mm	90
14 clés mâles 6 pans coudées Ø 1,5 - 2 - 2,5 - 3 - 4 - 5 - 6 - 8 - 10 - 12 - 13 - 14 - 17 - 19 mm	96N
1 Clé à molette à ouverture graduée, chromée 250 mm	111E
1 clé serre - tubes modèle américain 300 mm	362
25 forets taillés, série courte 1+13x0,5 mm	412/SP25
37 composition de tarauds et de filières en acier HSS	447/C37
1 clé dynamométrique à déclenchement avec cliquet réversible Ⓢ 1/2", 40÷200 Nm	666N/20
1 poignée à béquille à cardan 1/2"	920/40
4 douilles tournevis pour vis 6 pans creux carré femelle 1/2" Ø 10-12-14-17 mm	920ME
25 20 douilles et 5 accessories	920A/C20X
17 composition de 12 douilles et 5 accessoires 3/4"	928A/C12
12 clés à pipe débouchées 6 et 12 pans gros effort 8 - 10 - 11 - 13 - 14 - 17 - 19 - 22 - 24 - 27 - 30 - 32 mm	932
14 clés mâles 6 pans en T 2÷14 mm	951/S14
5 clés mâles 6 pans à béquille à cardan Ø 3 - 4 - 5 - 6 - 8 mm	953
3 pinces pour circlips intérieurs à bords droits Ø 180 - 225 - 300 mm	1032
3 pinces pour circlips intérieurs à bords coudés Ø 170 - 210 - 290 mm	1034
3 pinces pour circlips extérieurs à bords droits ● 140x1,3 - 175 - 225 mm	1036
3 pinces pour circlips extérieurs à bords coudés ● 135x1,3 - 175 - 220 mm	1038
2 Pince multiprise entrepassée 250 - 300 mm	1048N
1 pince-étau à bords longs	1051
1 pince coupante diagonale à faible effort de coupe, branchées gainées confort bi-matières, finition industrielle ⚡ 160 mm	1084GBM
1 pince coupante frontale articulée, série lourde ⚡ 180 mm	1092V
1 cisaille type américain coupe droite 300 mm	1112
1 cisaille bichantourneuse bac de canard 250 mm	1114
1 ciseaux d'électricien	1128BMX
1 pince universelle, branches gainées confort bi-matières, modèle grande capacité, finition industrielle ≡ 180 mm	1150GBM
1 pince à bords demi-ronds longs striés, branches gainées confort bi-matières, finition industrielle ● 160 mm	1166GBM
1 pince à bords coudés demi-ronds longs striés, branches gainées confort bi-matières, finition industrielle ● 160 mm	1168GBM
9 tournevis pour vis à fente ● 2,5x50 - 3x75 - 3,5x150 - 4x125 - 5,5x125 - 6,5x150 - 8x200 - 10x200 - 12x250 mm	1260
2 tournevis à lame courte pour vis à fente ● 4x30 - 6,5x30 mm	1260N
5 tournevis pour vis Phillips® Ⓢ PH0x100 - PH1x120 - PH2x150 - PH3x150 - PH4x200 mm	1262
2 tournevis à lame courte pour vis Phillips® Ⓢ PH1x30 - PH2x30 mm	1262N
7 tournevis pour vis Torx® Ⓢ T6 - T8 - T10 - T15 - T20 - T25 - T30	1267TX
2 marteau de mécanicien 300 - 600 g	1370
2 marteau de mécanicien Ø 35 - 60 mm	1390
5 extracteurs de goujons cassés M3÷M18	1430/S5
1 Extracteur universel à 2 griffes 23÷70 mm	1500N/1
1 Extracteur universel à 2 griffes 23÷100 mm	1500N/2
1 Pied à coulisse	1650
1 réglet semi-rigide 300 mm	1683
1 pointe à tracer en carbure	1688A
1 mètre à ruban 5 m	1692
1 jauge d'épaisseur	1708/13
1 doigt magnétique flexible 1,8 kg	1712E/2
5 limes demi-douces 200 mm	1719BMA8/S5
1 monture de scie à métaux	1726BM
1 pince à riveter	1741B
1 Burette tôle 200 cc	1751N

CHF



5910VI/3

8,720.00 059101044

Composition conseillé en association avec C30M

5910VI/3T

Composition de 261 outils en plateaux thermoformés rigides en ABS

► Maintenance industrielle

Quantité/Description

- 16 clés mixtes 6÷21 mm
- 5 clés mixtes 22 - 24 - 27 - 30 - 32 mm
- 5 chasse-goupilles Ø 2 - 3 - 4 - 5 - 6 mm
- 1 pointeau Ø 4 mm
- 13 clés à fourches 6x7 - 8x9 - 10x11 - 12x13 - 14x15 - 16x17
18x19 - 20x22 - 21x23 - 24x26 - 27x29 - 30x32 mm
- 9 clés mâles 6 pans coudées ⌀ 1,5 - 2 - 2,5 - 3 - 4 - 5 - 6 - 8 - 10 mm
- 5 clés polygonales contre - coudées 20x22 - 21x23 - 24x26 - 25x28 - 27x29 mm
- 7 clés polygonales contre - coudées 6x7 - 8x9 - 10x11 - 12x13
14x15 - 16x17 - 18x19 mm
- 5 douilles tournevis pour vis 6 pans creux carré femelle 1/2" ⌀ 5 - 6 - 8 - 10 - 12 mm
- 1 rallonge - 1/2" 125 mm
- 1 rallonge - 1/2" 255 mm
- 1 cardan 1/2"
- 1 poignée coulissante 1/2"
- 1 cliquet réversible 1/2" Ⓢ
- 19 douilles 6 pans avec carré conducteur femelle 1/2" ⌀ 10÷24 - 26 - 27 - 30 - 32 mm
- 9 tournevis pour vis à fente ● 3x75 - 3x100 - 4x100 - 4x150 - 5,5x100 - 5,5x150 - 6,5x150 -
8x150 - 10x200 mm
- 2 tournevis à lame courte pour vis à fente ● 4x30 - 6,5x30 mm
- 7 tournevis pour vis Phillips® ● PH0x60 - PH0x100 - PH1x80
PH1x120 - PH2x100 - PH2x150 - PH3x150 mm
- 2 tournevis à lame courte pour vis Phillips® ● PH1x30 - PH2x30 mm
- 4 clés mâles 6 pans coudées ⌀ 13-14-17-19 mm
- 1 cisaille type américain coupe droite 250 mm
- 1 ciseaux d'électricien
- 1 monture de scie à métaux
- (5) lames de scies
- 1 Burette plastique sous pression 200 cc
- 1 pince à becs demi-ronds longs ■ 180 mm
- 1 Pince à becs demi-ronds longs ● 160 mm
- 1 Pince coupante diagonale à faible effort de coupe ✂ 160 mm
- 1 pinces pour circlips intérieurs à becs droits ○ 180 mm
- 1 pinces pour circlips intérieurs à becs coudés ○ 170 mm
- 1 pinces pour circlips extérieurs à becs droits ● 175mm
- 1 pinces pour circlips extérieurs à becs coudés ● 175mm
- 2 burins nervurés 100 - 200 mm
- 1 marteau de mécanicien 300 g
- 1 marteau de mécanicien Ø 35 mm
- 1 limes demi-douces 200 mm
- 4 clés mixtes 35-36-38-41 mm
- 1 clés à fourches 36x41 mm
- 1 Clé à molette à ouverture graduée, chromée 250 mm
- 1 clé serre - tubes modèle américain 300 mm
- 25 forets taillés, série courte
- 37 composition de tarauds et de filières en acier HSS
- 1 clé dynamométrique à déclenchement avec cliquet réversible Ⓢ 200 Nm
- 17 composition de 12 douilles et 5 accessoires 3/4"
- 14 clés mâles 6 pans en T
- 5 clés mâles 6 pans à béquille à cardan ⌀ 3-4-5-6-8 mm
- 1 pinces pour circlips intérieurs à becs droits ○ 300 mm
- 1 pinces pour circlips intérieurs à becs coudés ○ 290 mm
- 1 pinces pour circlips extérieurs à becs droits ● 225 mm
- 1 pinces pour circlips extérieurs à becs coudés ● 220 mm
- 1 Pince multiprise entrecroisée 300 mm
- 1 pince-étau à becs longs
- 1 pince coupante frontale articulée, série lourde ✂ 180 mm
- 1 marteau de mécanicien 600 g
- 1 marteau de mécanicien 60 mm
- 5 extracteurs de goujons cassés M3-M18
- 1 Extracteur universel à 2 griffes
- 1 Pied à coulisse
- 1 réglet semi-rigide
- 1 pointe à tracer en carbure
- 1 mètre à ruban 5 m
- 1 jauge d'épaisseur
- 1 doigt magnétique flexible

Réf. Beta	TR
42	T05
42	T06
31	T31
32	T31
55	T31
96N/SC9	T31
90	T41
90	T40
920ME	T80
920/21	T80
920/22	T80
920/25	T80
920/42	T80
920/55	T80
920A	T80
1260	T167
1260N	T167
1262	T168
1262N	T168
96N	T168
1112	T285
1128BM	T285
1726	T285
1728BM	T285
1753	T285
1150BM	T137
1166BM	T137
1084BM	T137
1032	T145
1034	T145
1036	T145
1038	T145
35	T234
1370	T234
1390	T234
1719BMA8/S5	T236
42	
55	
111E	
362	
412/SP25	
447/C37	
666N/20	
928A/C12	
951/S14	
953	
1032	
1034	
1036	
1038	
1048N	
1051	
1092V	
1370	
1390	
1430/S5	
1500/3	
1650	
1683	
1688	
1692	
1708/13	
1712E/2	



T05 T06 T31



T40 T41 T80



T167 T168 +96N



T137 T145 T285 T234 T236



CHF

5910VI/3T

7,440.00 059101063

Composition conseillé en association avec C30M

5935VI/2MB

Composition de 133 outils pour coffre C35, en plateaux mousse compacte

► Maintenance industrielle

Quantité/Description

- 21 clés mixtes 6-7-8-9-10-11-12-13-14-15-16-17-18-19-20-21-22-24-27-30-32 mm
- 8 clés à fourches 6x7-8x9-10x11-12x13-14x15
- 16x17-18x19-20x22 mm
- 1 Pince multiprise entrepassée 250 mm
- 19 douilles 6 pans avec carré conducteur femelle 1/2" ○ 10-11-12-13-14-15-16-17-18-19-20-21-22-23-24-26-27-30-32 mm
- 1 rallonge angulaire - 1/2" 125 mm
- 1 rallonge angulaire - 1/2" 150 mm
- 1 cardan 1/2"
- 1 poignée coulissante 1/2"
- 1 cliquet réversible 1/2" ⊕
- 1 Clé à molette à ouverture graduée, chromée 250 mm
- 1 pince - étau à becs droits 240 mm
- 1 Pince coupante diagonale à faible effort de coupe ∇ 160 mm
- 1 pince à becs demi-ronds longs \equiv 180 mm
- 1 Pince à becs demi-ronds longs ● 160 mm
- 1 pinces pour circlips intérieurs à becs droits ○ 180 mm
- 1 pinces pour circlips intérieurs à becs coudés ○ 170 mm
- 1 pinces pour circlips extérieurs à becs droits ● 175 mm
- 1 pinces pour circlips extérieurs à becs coudés ● 175 mm
- 13 douilles 6 pans avec carré conducteur femelle 1/4" ○ 4-4,5-5-5,5-6-7-8-9-10-11-12-13-14 mm
- 1 rallonge - 1/4" 50 mm
- 1 rallonge - 1/4" 150 mm
- 1 cardan avec carrés mâle et femelle 1/4"
- 1 poignée emmanchée avec carré mâle 1/4"
- 1 cliquet réversible avec carré mâle 1/4" ⊕
- 1 poignée coulissante avec carré mâle 1/4"
- 7 tournevis pour vis à fente ● 2,5x50-3x75-3,5x100-4x100-5,5x125-6,5x150-8x200 mm
- 2 tournevis à lame courte pour vis à fente ● 4x30-6,5x30 mm
- 7 tournevis pour vis Phillips ⊕ PH0x60-PH0x100-PH1x80
- PH1x120-PH2x100-PH2x150-PH3x150 mm
- 2 tournevis à lame courte pour vis Phillips ⊕ PH1x30-PH2x30 mm
- 1 tournevis détecteur de tension ● 4x30-6,5x30 mm
- 9 clés mâles 6 pans coudées à tête sphérique ○
- 6 clés mâles 6 pans en T ○ 2,5-3-4-5-6-8 mm
- 5 chasse-goupilles Ø 2-3-4-5-6 mm
- 1 pointeau Ø 4 mm
- 1 burins nervurés 200 mm
- 1 cisaille type américain coupe droite 250 mm
- 1 ciseaux d'électricien
- 1 marteau de mécanicien 500 g
- 1 marteau de mécanicien Ø 45 mm
- 1 Lime carrée demi-douce 200 mm
- 1 Lime triangulaire demi-douce 200 mm
- 1 Lime plate demi-douce 200 mm
- 1 Lime demi-ronde demi-douce 200 mm
- 1 lime ronde demi-douce 200 mm
- 1 monture de scie à métaux 440 mm

Réf. Beta	TR
42	MB12
55	MB12
1048N	MB12
920A	MB37
920AN/125	MB37
920AN/250	MB37
920/25	MB37
920/42	MB37
920/55	MB37
111E	MB37
1052	MB37
1084BM	MB37
1150BM	MB37
1166BM	MB37
1032	MB37
1034	MB37
1036	MB37
1038	MB37
900	MB37
900/20	MB37
900/21	MB37
900/25	MB37
900BG/30	MB37
900/55	MB37
900/42	MB37
1260	MB44
1260N	MB44
1262	MB44
1262N	MB44
1253	MB44
96BPC/SC9	MB44
951	MB44
31	MB55
32	MB55
35	MB55
1112	MB55
1128BMX	MB55
1370	MB55
1390	MB55
1719BMA...Q	MB55
1719BMA...T	MB55
1719BMA...P	MB55
1719BMA...M	MB55
1719BMA...R	MB55
1726	MB55



MB12



MB37

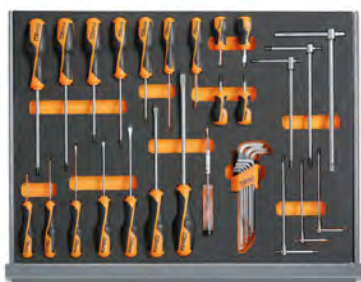

MB44



MB55

CHF

5935VI/2MB

2,840.00 059351316

Composition conseillée avec C35



5957VI

Composition de 162 outils

► Maintenance industrielle

Quantité/Description	Réf. Beta
6 chasse-goupilles Ø 2 - 3 - 4 - 5 - 6 - 8 mm	31/SP6
6 2 chasse - clous, 1 pointeau, 2 burins plats, 1 bédane, sur présentoir	38/SP6
18 clés mixtes 6-7-8-10-11-12-13-14-15-16-17-19-21-22-24-27-30-32 mm	42
12 clés à fourches 6x7 + 30x32 mm	55/S12X
8 clés mâles 6 pans à poignée en T 2 - 2,5 - 3 - 4 - 5 - 6 - 8 - 10 mm	96T/S8
8 clés mâles coudées pour vis Torx® Ⓢ T9 - T10 - T15 - T20 - T25 - T27 - T30 - T40	97TX/SC8
1 Clé à molette à ouverture graduée, chromée 250 mm	111E
13 douilles 12 pans 1/2" sur rail ⌀ 10+22 mm	920B/SB13
8 douilles 12 pans 1/2" sur rail ⌀ 23+32 mm	920B/SB8
4 douilles pour vis à fente 1/2" ● 1,2x6,5 - 1,2x8 - 1,6x9 - 2x12 mm	920LP
3 douilles pour vis Phillips® 1/2" Ⓢ PH2 - 3 - 4	920PH
1 rallonge - 1/2" 125 mm	920/21
1 rallonge - 1/2" 255 mm	920/22
1 cardan 1/2"	920/25
1 poignée coulissante 1/2"	920/42
1 cliquet réversible 1/2" Ⓢ	920/55
1 pince levier à broche et palette	963
2 pinces pour circlips intérieurs à becs droits Ⓢ 140 - 180 mm	1032
2 pinces pour circlips intérieurs à becs coudés Ⓢ 130 - 170 mm	1034
2 pinces pour circlips extérieurs à becs droits ● 140 - 175 mm	1036
2 pinces pour circlips extérieurs à becs coudés ● 135 - 175 mm	1038
1 Pince multiprise entrecroisée 250 mm	1048N
1 pince-étau à becs longs	1051
1 Pince coupante diagonale à faible effort de coupe ⚡ 160 mm	1084BM
1 pince coupante frontale articulée, série lourde ⚡ 180 mm	1092V
1 cisaille type américain coupe droite 250 mm	1112
1 cisaille bichantourneuse bac de canard 250 mm	1114
1 ciseaux d'électricien	1128BMX
1 pince à becs demi-ronds longs = 180 mm	1150BM
1 Pince à becs demi-ronds longs ● 160 mm	1166BM
1 Pince à becs coudés demi-ronds ● 160 mm	1168BM
7 tournevis pour vis à fente ● 2,5x50 - 3x75 - 4x100 5,5x125 - 6,5x150 - 8x200 - 10x200 mm	1260
4 tournevis pour vis Phillips® Ⓢ PH0x60 - PH1x80 - PH2x100 - PH3x150 mm	1262
3 marteau de mécanicien 300 - 600 - 1000 g	1370
1 marteau de mécanicien Ø 35 mm	1390
1 mètre à ruban 5 m	1692
1 doigt magnétique flexible 1,8 kg	1712E/2
1 grattoir feuille de sauge 200 mm	1717A
1 grattoir triangulaire 200 mm	1717B
5 limes demi-douces 200 mm	1719BMA8/S5
1 monture de scie à métaux	1725
1 burette tôle à embout flexible 200 cc	1751
1 burins nervurés 200 mm	35
1 bédane nervuré 200 mm	37
11 clés à pipe débouchées 6 et 12 pans gros effort 8 - 10 - 11 - 12 - 13 - 14 - 16 - 17 - 19 - 22 - 24 mm	932
1 pince - étau à becs droits 240 mm	1052
1 pince - étau à becs droits 280 mm	1060
1 pince - étau à becs droits 290 mm	1062
1 massette sans rebond Ø 50 mm	1392
1 Extracteur universel à 2 griffes 25+130 mm	1500N/2
1 Pied à coulisse	1650
1 réglet semi-rigide 300 mm	1683
1 pointe à tracer en carbure	1688A
1 jauge d'épaisseur	1708/13
1 couteau d'électricien avec dénudeur	1777BM
1 cutter à lame sécable 18 mm avec lames 170 mm	1771BM
1 Pince coupante diagonale ⚡ 160 mm	1082BM

CHF



5957VI 4,380.00 059571005

Composition conseillée avec C57S A - C57S B - C57SP - C55PSP

5954VI

Composition de 133 outils

► Maintenance industrielle

Quantité/Description	Réf. Beta
5 chasse-goupilles Ø 2-3-4-5-6 mm	31
1 pointeau Ø 4 mm	32
2 burins nervurés 200-250 mm	35
18 clés mixtes 6+14 - 16 - 17 - 18 - 19 - 21 - 22 - 24 - 27 - 30 mm	42
12 clés à fourches 6x7 - 8x9 - 10x11 - 12x13 - 14x15 - 16x17 18x19 - 20x22 - 21x23 - 24x26 - 27x29 - 30x32 mm	55
12 clés mâles 6 pans coudées Ø 2+10 mm	96/SC12
1 Clé à molette à ouverture graduée, chromée 250 mm	111E
1 clé serre - tube modèle suédois tête inclinée à 45° 320 mm	374
20 douilles 6 pans avec carré conducteur femelle 1/2" Ø 10+24 - 26 - 27 - 28 - 30 - 32 mm	920A
6 douilles tournevis pour vis 6 pans creux carré femelle 1/2" Ø 5 - 6 - 8 - 10 - 12 - 14 mm	920ME
1 rallonge - 1/2" 125 mm	920/21
1 rallonge - 1/2" 255 mm	920/22
1 cardan 1/2"	920/25
1 poignée à béquille à cardan 1/2"	920/40
1 poignée coulissante 1/2"	920/42
1 cliquet réversible 1/2" Ⓢ	920/55
6 clés mâles 6 pans en T Ø 2,5 - 3 - 4 - 5 - 6 - 8 mm	951
2 pinces pour circlips intérieurs à bords droits Ø 140 - 180 mm	1032
1 pinces pour circlips intérieurs à bords coudés Ø 170 mm	1034
2 pinces pour circlips extérieurs à bords droits Ø 140x1,3 - 175 mm	1036
1 pinces pour circlips extérieurs à bords coudés Ø 175 mm	1038
1 Pince multiprise entrecroisée 250 mm	1048N
1 pince - étau à bords droits 240 mm	1052
1 Pince coupante diagonale à faible effort de coupe L 160 mm	1084BM
1 pince coupante frontale articulée, série lourde L 180 mm	1092V
1 cisaille type américain coupe droite 250 mm	1112
1 ciseaux d'électricien	1128BMX
1 pince à bords demi-ronds longs = 180 mm	1150BM
1 Pince à bords demi-ronds longs ● 160 mm	1166BM
1 tournevis détecteur de tension ●	1253
2 tournevis pour vis à fente ● 8x150 - 10x200 mm	1260
2 tournevis à lame courte pour vis à fente ● 4x30 - 6,5x30 mm	1260N
2 tournevis pour vis Phillips® PH3x150 - PH4x200 mm	1262
2 tournevis à lame courte pour vis Phillips® PH1x30 - PH2x30 mm	1262N
8 tournevis	1263/D8
2 marteau de mécanicien 300 - 500 g	1370
1 marteau de mécanicien Ø 45 mm	1390
1 mètre à ruban 5 m	1692
1 doigt magnétique flexible 0,5 kg	1712E/1
5 limes demi-douces 200 mm	1719BMA8/S5
1 monture de scie à métaux	1726BM
1 burette plastique 250 cc	1754



CHF

5954VI

3,000.00 059541053

Composition conseillée avec C54S-C55C

5904VU/1M

Composition de 91 outils en plateaux mousse compacte

► Maintenance générale

Quantité/Description

- 16 clés mixtes 6÷21 mm
- 8 clés à fourches 6x7 - 8x9 - 10x11 - 12x13 - 14x15 - 16x17
18x19 - 20x22 mm
- 9 clés mâles 6 pans coudées ∅ 1,5 - 2 - 2,5 - 3 - 4 - 5 - 6 - 8 - 10 mm
- 6 tournevis pour vis Torx® ∅ T8-T10-T15-T20-T25-T30
- 3 tournevis pour vis à fente ∅ 3x75-4x100-6,5x150 mm
- 3 tournevis pour vis Phillips® ∅ PH0x60-PH1x80-PH2x100 mm
- 8 clés mâles 6 pans à poignée en T ∅ 2-2,5-3-4-5-6-7-8 mm
- 1 rallonge angulaire - 1/2" 125 mm
- 1 rallonge angulaire - 1/2" 250 mm
- 1 cardan 1/2"
- 1 poignée coulissante 1/2"
- 1 cliquet réversible 1/2" ∅
- 19 douilles 6 pans avec carré conducteur femelle 1/2" ∅ 10÷24 - 26 - 27 - 30 - 32 mm
- 1 Pince coupante diagonale à faible effort de coupe ∅ 160 mm
- 1 pince à becs demi-ronds longs = 180 mm
- 1 Pince à becs demi-ronds longs ∅ 160 mm
- 1 Pince multiprise entrepassée 250 mm
- 1 pince - étau à becs droits 240 mm
- 2 burins nervurés 100 - 200 mm
- 1 marteau de mécanicien 300 g
- 1 marteau de mécanicien ∅ 35 mm
- 1 pinces pour circlips intérieurs à becs droits ∅ 180 mm
- 1 pinces pour circlips intérieurs à becs coudés ∅ 170 mm
- 1 pinces pour circlips extérieurs à becs droits ∅ 175 mm
- 1 pinces pour circlips extérieurs à becs coudés ∅ 175 mm

Réf. Beta	TR
42	M05
55	M33
96/SC9	M33
1267TX	M204
1260	M201
1262	M201
96T	M50
920AN/125	M83
920AN/250	M83
920/25	M83
920/42	M83
920/55	M83
920A	M83
1084	M137
1150	M137
1166	M137
1048N	M153
1052	M153
35	M234
1370	M234
1390	M234
1032	M145
1034	M145
1036	M145
1038	M145



M05 M33 M204 M201



M50 M83



M137 M153 M234 M145

CHF

5904VU/1M

1,735.00 059041201

Composition conseillée avec RSC24 - RSC24A - RSC24AXL - C37 - C39 à 6 - 7 - 8 tiroirs
RSC23T - C39T - RSC24L - RSC24L-CAB - C59 - C55 - RSC28 - C39SM - C39MD

5904VU/2M

Composition de 151 outils en plateaux mousse compacte

► Maintenance générale

Quantité/Description

- 16 clés mixtes 6÷21 mm
- 8 clés à fourches 6x7 - 8x9 - 10x11 - 12x13 - 14x15 - 16x17 - 18x19 - 20x22 mm
- 9 clés mâles 6 pans coudées \odot 1,5 - 2 - 2,5 - 3 - 4 - 5 - 6 - 8 - 10 mm
- 3 tournevis pour vis à fente \bullet 3x75-4x100-6,5x150 mm
- 3 tournevis pour vis Phillips® \oplus PH0x60-PH1x80-PH2x100 mm
- 6 tournevis pour vis Torx® \otimes T8-T10-T15-T20-T25-T30
- 8 clés mâles 6 pans à poignée en T \odot 2-2,5-3-4-5-6-7-8 mm
- 1 rallonge angulaire - 1/2" 125 mm
- 1 rallonge angulaire - 1/2" 250 mm
- 1 cardan 1/2"
- 1 poignée coulissante 1/2"
- 1 cliquet réversible 1/2" \oplus
- 19 douilles 6 pans avec carré conducteur femelle 1/2" \odot 10÷24 - 26 - 27 - 30 - 32 mm
- 1 Pince coupante diagonale à faible effort de coupe \llcorner 160 mm
- 1 pince à becs demi-ronds longs \equiv 180 mm
- 1 Pince à becs demi-ronds longs \bullet 160 mm
- 1 Pince multiprise entrepassée 250 mm
- 1 pince - étou à becs droits 240 mm
- 2 burins nervurés 100 - 200 mm
- 1 marteau de mécanicien 300 g
- 1 maillet à embouts nylon \varnothing 35 mm
- 1 pinces pour circlips intérieurs à becs droits \odot 180 mm
- 1 pinces pour circlips intérieurs à becs coudés \odot 170 mm
- 1 pinces pour circlips extérieurs à becs droits \bullet 175 mm
- 1 pinces pour circlips extérieurs à becs coudés \bullet 175 mm
- 1 plateau thermoformé souple
- 1 mètre à ruban 5 m
- 1 mini - monture de scie à métaux
- 1 burette plastique 30 cc
- 1 cutter à lame sécable 18 mm avec lames
- 5 Embout coloré pour visseuses pour vis à fente \bullet 0,5x3 - 0,6x4,5 - 0,8x5,5 - 1x5,5 - 1,2x6,5 mm
- 8 Embout coloré pour visseuses pour vis 6 pans creux \odot 2 - 2,5 - 3 - 4 - 5 - 6 - 8 - 10 mm
- 5 Embout coloré pour visseuses pour vis Phillips® \oplus PH0 - PH1 - PH2 - PH3 - PH4
- 4 Embout coloré pour visseuses pour vis Pozidriv® - Supadriv® \oplus PZ1 - PZ2 - PZ3 - PZ4
- 11 Embout coloré pour visseuses pour vis Torx® \otimes T6-T7-T8-T9-T10-T15-T20-T25-T27-T30-T40
- 8 Embout coloré pour visseuses pour vis Tamper Resistant Torx® \oplus T9-T10-T15-T20-T25-T27-T30-T40
- 1 Poignée porte-embouts à bague de déverrouillage rapide 230 mm
- 1 Cliquet réversible porte-embouts 100 mm
- 5 limes demi-douces 200 mm
- 1 porte-douille pour visseuses
- 1 rallonge porte-embouts magnétique

Réf. Beta	TR
42	M05
55	M33
96/SC9	M33
1260	M201
1262	M201
1267TX	M204
96T	M50
920AN/125	M83
920AN/250	M83
920/25	M83
920/42	M83
920/55	M83
920A	M83
1084	M137
1150	M137
1166	M137
1048N	M153
1052	M153
35	M237
1370T	M237
1390N	M237
1032	M145
1034	M145
1036	M145
1038	M145
VPM3	VPM3
1692	M289
1725CR	M289
1755	M289
1771	M289
860LP	M85
860PE	M85
860PH	M85
860PZ	M85
860TX	M85
860RTX	M85
851SR	M85
860/55	M85
1719BMA8/S5	M236
8920	M85
882P	M85



M05 M33 M204 M201



M50 M83



M137 M153 M237 M145



VPM3 M289 M85 M236

CHF

5904VU/2M

2,225.00 059041212

Composition conseillée avec RSC24 - RSC24A - C37 - C39
RSC24L - RSC24L-CAB - C59 - C55 - C23 - RSC28 - C39SM - C39MD - C39T

5904VU/2T

Composition de 104 outils en plateaux thermoformés rigides en ABS

► Maintenance générale

Quantité/Description

Quantité/Description	Réf. Beta	TR
7 tournevis pour vis à fente ● 2,5x50 - 3x75 - 3,5x100 - 4x125 5,5x100 - 5,5x150 - 6,5x150 mm	1260	T199
6 tournevis pour vis Phillips® ● PH0x60 - PH0x100 - PH1x80 - PH1x120 - PH2x100 - PH2x150 mm	1262	T202
19 douilles 6 pans avec carré conducteur femelle 1/2" ○ 10-11-12-13-14-15-16-17-18-19 20-21-22-23-24-26-27-30-32 mm	920A	T83
1 rallonge - 1/2" 125 mm	920/21	T83
1 rallonge - 1/2" 255 mm	920/22	T83
1 cardan 1/2"	920/25	T83
1 poignée coulissante 1/2" 305 mm	920/42	T83
1 cliquet réversible 1/2" ⊗	920/55	T83
1 pinces pour circlips intérieurs à becs droits ○ 180 mm	1032	T145
1 pinces pour circlips intérieurs à becs coudés ○ 170 mm	1034	T145
1 pinces pour circlips extérieurs à becs droits ● 175 mm	1036	T145
1 pinces pour circlips extérieurs à becs coudés ● 175 mm	1038	T145
1 Pince multiprise entrepassée 250 mm	1048N	T153
1 pince - étau à becs droits 240 mm	1052	T153
1 Pince coupante diagonale à faible effort de coupe ⚡ 160 mm	1084	T138
1 pince à becs demi-ronds longs = 180 mm	1150	T138
1 Pince à becs demi-ronds longs ● 160 mm	1166	T138
2 burins nervurés 100-200 mm	35	T234
1 marteau de mécanicien 300 g	1370	T234
1 marteau de mécanicien Ø 35 mm	1390	T234
6 clés mâles 6 pans en T ○ 2,5-3-4-5-6-8 mm	951	T68
8 clés à fourches 6x7-8x9-10x11-12x13-14x15 16x17-18x19-20x22 mm	55	T33
9 clés mâles 6 pans coudées ○ 1,5+10 mm	96/SC9	T33
16 clés mixtes 6-7-8-9-10-11-12-13-14-15-16-17 18-19-20-21 mm	42	T05
5 clés mixtes 22-24-27-30-32 mm	42	T06
1 ciseaux d'électricien	1128BMX	T284
1 Ciseaux multifonctions	1130BMX	T284
1 Lime carrée demi-douce 200 mm	1719BMA...Q	T284
1 Lime plate demi-douce 200 mm	1719BMA...P	T284
1 Lime triangulaire demi-douce 200 mm	1719BMA...T	T284
1 Lime demi-ronde demi-douce 200 mm	1719BMA...M	T284
1 lime ronde demi-douce 200 mm	1719BMA...R	T284
1 monture de scie à métaux	1726BM	T284
1 lames de scies	1728BM	T284
1 cutter à lame sécable 18 mm avec lames 170 mm	1771BM	T284
1 couteau à cran d'arrêt en aluminium 185 mm	1778	T284



T199 T202 T83



T145 T153 T138 T234



T68 T33 T05 T06



T284

CHF

5904VU/2T

2,090.00 059041070

Composition conseillée avec RSC24 - RSC24A - C37 - C39
RSC24L - RSC24L-CAB - C59 - C55 - RSC23T - RSC28 - C39SM - C39MD - C39T

5904VU/3T

Composition de 146 outils en plateaux thermoformés rigides en ABS

► Maintenance générale

Quantité/Description

- 16 clés mixtes 6+21 mm
- 5 clés mixtes 22 - 24 - 27 - 30 - 32 mm
- 5 chasse-goupilles Ø 2 - 3 - 4 - 5 - 6 mm
- 1 pointeau Ø 4 mm
- 12 clés à fourches 6x7 - 8x9 - 10x11 - 12x13 - 14x15 - 16x17 - 18x19 - 20x22 - 21x23 - 24x26 - 27x29 - 30x32 mm
- 9 clés mâles 6 pans coudées Ø 1,5 - 2 - 2,5 - 3 - 4 - 5 - 6 - 8 - 10 mm
- 6 clés mâles 6 pans à poignée en T Ø 2 - 2,5 - 3 - 4 - 5 - 6 mm
- 6 tournevis pour vis Torx® ⚙ T10-T15-T20-T25-T27-T30
- 5 douilles tournevis pour vis 6 pans creux carré femelle 1/2" Ø 5 - 6 - 8 - 10 - 12 mm
- 1 rallonge - 1/2" 125 mm
- 1 rallonge - 1/2" 255 mm
- 1 cardan 1/2"
- 1 poignée coulissante 1/2"
- 1 cliquet réversible 1/2" ⚙
- 19 douilles 6 pans avec carré conducteur femelle 1/2" Ø 10+24 - 26 - 27 - 30 - 32 mm
- 13 douilles 6 pans avec carré conducteur femelle 1/4" Ø 4-4,5-5-5,5-6-7-8-9-10-11-12-13-14 mm
- 6 douilles tournevis pour vis 6 pans creux carré femelle 1/4" Ø 2,5-3-4-5-6-8 mm
- 1 rallonge - 1/4" 50 mm
- 1 rallonge - 1/4" 150 mm
- 1 cardan avec carrés mâle et femelle 1/4"
- 1 poignée emmanchée avec carré mâle 1/4"
- 1 poignée coulissante avec carré mâle 1/4" 115 mm
- 1 cliquet réversible avec carré mâle 1/4" ⚙
- 1 pinces pour circlips intérieurs à becs droits ⚙ 180 mm
- 1 pinces pour circlips intérieurs à becs coudés ⚙ 170 mm
- 1 pinces pour circlips extérieurs à becs droits ⚙ 175 mm
- 1 pinces pour circlips extérieurs à becs coudés ⚙ 175 mm
- 1 pince à becs demi-ronds longs ≡ 180 mm
- 1 Pince à becs demi-ronds longs ⚙ 160 mm
- 1 Pince coupante diagonale à faible effort de coupe ≡ 160 mm
- 1 Pince multiprise entrepassée 250 mm
- 1 pince - étau à becs droits 240 mm
- 4 tournevis pour vis à fente ⚙ 3x75 - 4x100 - 5,5x150 - 6,5x150 mm
- 3 tournevis pour vis Pozidriv®-Supadriv® ⚙ PZ0 - PZ1 - PZ2
- 7 tournevis pour vis Torx® ⚙ T6-T7-T8-T9-T10-T15-T20
- 2 burins nervurés 100 - 200 mm
- 1 marteau de mécanicien 300 g
- 1 marteau de mécanicien Ø 35 mm
- 5 limes demi-douces 200 mm

Réf. Beta	TR
42	T05
42	T06
31	T31
32	T31
55	T31
96N/SC9	T31
96T	T52
97TTX	T55
920ME	T80
920/21	T80
920/22	T80
920/25	T80
920/42	T80
920/55	T80
920A	T80
900	T91
900ME	T91
900/20	T91
900/21	T91
900/25	T91
900BG/30	T91
900/42	T91
900/55	T91
1032	T145
1034	T145
1036	T145
1038	T145
1150	T138
1166	T138
1084	T138
1048N	T153
1052	T153
1260	T198
1269PZ	T198
1267TX	T205
35	T234
1370	T234
1390	T234
1719BMA8/S5	T236



T05 T06 T31



T52 T55 T80



T91 T145 T138 T153



T198 T205 T234 T236

CHF

5904VU/3T

2,540.00 059041203

Composition conseillée avec RSC24 - RSC24A - C37 - C39

RSC24L - RSC24AXL - RSC24L-CAB - C59 - C55 - C39T - C39SM - C39MD - RSC23T - RSC28

5904VU/4T

composition de 197 outils en plateaux thermoformés rigides en ABS

► Maintenance générale

Quantité/Description

- 1 chasse-clous Ø 4 mm
- 1 chasse-goupilles Ø 4 mm
- 1 pointeau Ø 4 mm
- 54 jeu de 52 embouts avec entraînement hexagonal de 10 mm et 2 accessoires
- 17 clés mixtes 6-7-8-10-11-12-13-14-16-17-18-19-21-22-24-27-30 mm
- 7 clés polygonales contre - coudées 6x7-8x9-10x11-12x13-14x15-16x17-18x19 mm
- 19 douilles 6 pans avec carré conducteur femelle 1/2" ○ 10-11-12-13-14-15-16-17-18-19-20-21-22-23-24-26-27-30-32 mm
- 1 rallonge - 1/2" 125 mm
- 1 rallonge - 1/2" 250 mm
- 1 cardan 1/2"
- 1 poignée coulissante 1/2" 305 mm
- 1 cliquet réversible 1/2" ⊕
- 13 douilles 6 pans avec carré conducteur femelle 1/4" ○ 4-4,5-5-5,5-6-7-8-9-10-11-12-13-14 mm
- 6 douilles tournevis pour vis 6 pans creux carré femelle 1/4" ○ 2,5-3-4-5-6-8 mm
- 1 rallonge - 1/4" 50 mm
- 1 rallonge - 1/4" 150 mm
- 1 cardan avec carrés mâle et femelle 1/4"
- 1 poignée emmanchée avec carré mâle 1/4"
- 1 poignée coulissante avec carré mâle 1/4" 115 mm
- 1 cliquet réversible avec carré mâle 1/4" ⊕
- 1 Pince coupante diagonale ✂ 160 mm
- 1 pince à becs demi-ronds longs = 180 mm
- 1 Pince multiprise entrepassée 250 mm
- 7 tournevis pour vis à fente ● 2,5x50 - 3x75 - 3,5x100 - 4x125 - 5,5x100 - 5,5x150 - 6,5x150 mm
- 6 tournevis pour vis Phillips® ⊕ PH0x60 - PH1x80 - PH1x120 - PH2x100 - PH2x150 - PH3x150 mm
- 7 tournevis pour vis Torx® ⊖ T6-T7-T8-T9-T10-T15-T20
- 2 burins nervurés 100-200 mm
- 1 marteau de mécanicien 300 g
- 1 marteau de mécanicien Ø 35 mm
- 7 clé mâle 6 pans coudée à tête sphérique, brunie ○ 2,5-3-4-5-6-8-10 mm
- 1 clés mâles 6 pans coudées ○ 12 mm
- 31 coffret de 31 pièces ● ○ ⊕ ⊖ ⊕ ⊖
- 1 douille porte-embouts

Réf. Beta	TR
	30
	31
	32
867/C52	42
	T01
	T40
920A	T83
920/21	T83
920/22	T83
920/25	T83
920/42	T83
920/55	T83
900	T91
900ME	T91
900/20	T91
900/21	T91
900/25	T91
900BG/30	T91
900/42	T91
900/55	T91
1082	T156
1150	T156
1048	T156
1201E	T211
1202E	T213
1207E/TX	T216
35	T234
1370	T234
1390	T234
96BP	T259
96N	T259
860MIX/A31	T259
895/1	T259



T01

T83

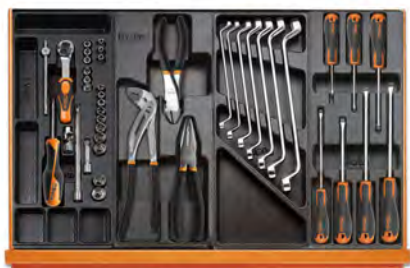

T91

T156

T40

T211



T213

T216

T234

T259

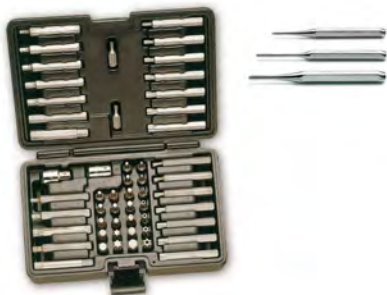

CHF

5904VU/4T

1,965.00 059241100

Composition conseillée avec RSC23T - RSC24 - RSC24A - RSC24AXL - RSC24L - RSC24L-CAB - C37 - C39 - C39T - C39SM - C39MD - RSC55 - C59

5908VU/2T

composition de 161 outils en plateaux thermoformés rigides en ABS

► Maintenance générale

Quantité/Description

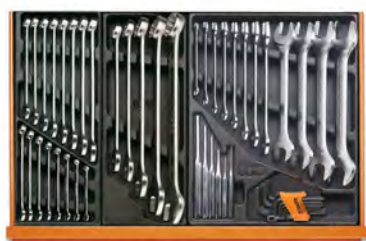

T05 T06 T31



T40 T52 T55 T91



T82 T138 T153



T145 T170 T171 T172



T173 T234 T236 VP4

Quantité/Description	Réf. Beta	TR
16 clés mixtes 6+21 mm	42	T05
5 clés mixtes 22 - 24 - 27 - 30 - 32 mm	42	T06
5 chasse-goupilles Ø 2 - 3 - 4 - 5 - 6 mm	31	T31
1 pointeau Ø 4 mm	32	T31
12 clés à fourches 6x7 - 8x9 - 10x11 - 12x13 - 14x15 - 16x17 - 18x19 - 20x22 - 21x23 - 24x26 - 27x29 - 30x32 mm	55	T31
9 clés mâles 6 pans coudées Ø 1,5 - 2 - 2,5 - 3 - 4 - 5 - 6 - 8 - 10 mm	96N/SC9	T31
7 clés polygonales contre - coudées 6x7-8x9-10x11-12x13-14x15-16x17-18x19 mm	90	T40
clés mâles 6 pans à poignée en T Ø 2-2,5-3-4-5-6 mm	96T	T52
6 tournevis pour vis Torx® Ⓢ T10-T15-T20-T25-T27-T30	97TTX	T55
19 douilles 6 pans avec carré conducteur femelle 1/2" Ⓞ 10-11-12-13-14-15-16-17-18-19-20-21-22-23-24-26-27-30-32 mm	920A	T82
5 douilles tournevis pour vis 6 pans creux carré femelle 1/2" Ⓞ 5-6-8-10-12 mm	920ME	T82
1 rallonge angulaire - 1/2" 125 mm	920AN/125	T82
1 rallonge angulaire - 1/2" 250 mm	920AN/250	T82
1 cardan 1/2"	920/25	T82
1 poignée coulissante 1/2" 305 mm	920/42	T82
1 cliquet réversible 1/2" Ⓢ	920/55	T82
13 douilles 6 pans avec carré conducteur femelle 1/4" Ⓞ 4-4,5-5-5,5-6-7-8-9-10-11-12-13-14 mm	900	T91
6 douilles tournevis pour vis 6 pans creux carré femelle 1/4" Ⓞ 2,5-3-4-5-6-8 mm	900ME	T91
1 rallonge - 1/4" 50 mm	900/20	T91
1 rallonge - 1/4" 150 mm	900/21	T91
1 cardan avec carrés mâle et femelle 1/4"	900/25	T91
1 poignée emmanchée avec carré mâle 1/4"	900BG/30	T91
1 poignée coulissante avec carré mâle 1/4" 115 mm	900/42	T91
1 cliquet réversible avec carré mâle 1/4" Ⓢ	900/55	T91
1 Pince coupante diagonale à faible effort de coupe 160 mm	1084	T138
1 pince à becs demi-ronds longs 180 mm	1150	T138
1 Pince à becs demi-ronds longs 160 mm	1166	T138
1 pinces pour circlips intérieurs à becs droits Ⓞ 180 mm	1032	T145
1 pinces pour circlips intérieurs à becs coudés Ⓞ 170 mm	1034	T145
1 pinces pour circlips extérieurs à becs droits Ⓞ 175 mm	1036	T145
1 pinces pour circlips extérieurs à becs coudés Ⓞ 175 mm	1038	T145
1 Pince multiprise entrecroisée 250 mm	1048N	T153
1 pince - étau à becs droits 240 mm	1052	T153
7 tournevis pour vis Phillips® Ⓢ 2,5x50-3x75-3,5x100-4x125-5,5x100-5,5x150-6,5x150 mm	1290	T170
3 tournevis pour vis Phillips® Ⓢ 8x150-8x200-10x200 mm	1290	T171
2 tournevis à lame courte pour vis à fente Ⓢ 4x30-6,5x30 mm	1290N	T171
6 tournevis pour vis Phillips® Ⓢ PH0x60-PH0x100-PH1x80-PH1x120-PH2x100-PH2x150 mm	1292	T172
2 tournevis pour vis Phillips® Ⓢ PH3x150-PH4x200 mm	1292	T173
2 tournevis à lame courte pour vis Phillips® Ⓢ PH1x30-PH2x30 mm	1292N	T173
2 burins nervurés 100-200 mm	35	T234
1 marteau de mécanicien 300 g	1370	T234
1 marteau de mécanicien Ø 35 mm	1390	T234
1 Lime carrée demi-douce 200 mm	1719BMA..Q	T236
1 Lime triangulaire demi-douce 200 mm	1719BMA..T	T236
1 Lime plate demi-douce 200 mm	1719BMA..P	T236
1 Lime demi-ronde demi-douce 200 mm	1719BMA..M	T236
1 lime ronde demi-douce 200 mm	1719BMA..R	T236
1	VP4	

CHF

5908VU/2T

2,880.00 059081136

Composition conseillée avec RSC23T - RSC24 à 6-7-8 tiroirs - RSC24A - RSC24AXL - RSC24L - RSC24L-CAB - RSC28 C37 à 6-7-8 tiroirs - C39 à 6-7-8 tiroirs - C39MD - C39SM - C59 - RSC55

5914VU/M

Composition de 109 outils pour chariot C14, en plateaux mousse compacte

► Maintenance générale

Quantité/Description

- 31 coffret de 31 pièces ● ○ ⊕ ⊕ ⊕
- 1 douille porte-embouts
- 13 douilles 6 pans avec carré conducteur femelle 1/4" ○ 4-4,5-5,5-6-7-8-9-10-11-12-13-14 mm
- 1 rallonge - 1/4" 150 mm
- 1 cardan avec carrés mâle et femelle 1/4"
- 1 poignée emmanchée carré mâle 1/4"
- 1 poignée coulissante avec carré mâle 1/4"
- 1 cliquet réversible avec carré mâle 1/4" ⊕
- 16 douilles 6 pans avec carré conducteur femelle 1/2" ○ 10-11-12-13-14-15-16-17-18-19-21-22-24-27-30-32 mm
- 1 cardan 1/2"
- 1 rallonge angulaire - 1/2"
- 1 poignée coulissante 1/2"
- 1 cliquet réversible 1/2" ⊕
- 16 clés mixtes 6-7-8-9-10-11-12-13-14-15-16-17-18-19-21-22 mm
- 9 clés mâles 6 pans coudées ○
- 1 Clé à molette à ouverture graduée, chromée 250 mm
- 1 ciseaux d'électricien
- 1 mètre à ruban 5 mt
- 1 cutter à lame sécable 18 mm avec lames
- 1 Pince multiprise entrepassée 250 mm
- 1 Pince coupante diagonale ⊕ 160 mm
- 1 pince à becs demi-ronds longs = 180 mm
- 1 Pince à becs demi-ronds longs ● 160 mm
- 3 tournevis pour vis à fente ● 3,5x100-5,5x125-6,5x150 mm
- 3 tournevis pour vis Phillips® ⊕ PH0x60-PH1x80-PH2x100 mm

Réf. Beta	TR
860MIX/A31	MCT1
895/1	MCT1
900	MCT1
900/...	MCT1
900/25	MCT1
900BG/30C	MCT1
900/42	MCT1
900/55	MCT1
920A	MCT1
920/25	MCT1
920AN/125	MCT1
920/42	MCT1
920/55	MCT1
42	MCT2
96/SC9	MCT2
111E	MCT2
1128BMX	MCT2
1692/5	MCT2
1771	MCT2
1048N	MCT3
1082BM	MCT3
1150BM	MCT3
1166BM	MCT3
1260	MCT3
1262	MCT3



MC T1



MC T2



MC T3

CHF

5914VU/M

1,385.00 059140112

Composition conseillée avec C14

5988U/7M

Composition de 215 outils en plateaux mousse compacte

► Maintenance générale

Quantité/Description



M01



M100

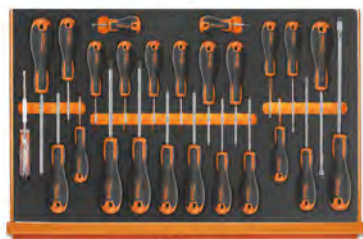

M213



M33 M86 M136 M234

Quantité/Description	Réf. Beta	TR
22 clés mixtes 6-7-8-9-10-11-12-13-14-15-16-17-18-19-20-21-22-24-27-30-32-36 mm	42	M01
8 clés à fourches 6x7-8x9-10x11-12x13-14x15-16x17-18x19-20x22 mm	55	M33
9 clés mâles 6 pans coudées \varnothing 1,5÷10 mm	96/SC9	M33
7 embout avec entraînement hexagonal \varnothing 4-5-6-7-8-10-12 mm	867PE	M86
7 embout avec entraînement hexagonal \varnothing 4-5-6-7-8-10-12 mm	867PEL	M86
5 embout avec entraînement hexagonal \varnothing 5-6-8-10-12 mm	867XZN	M86
5 embout avec entraînement hexagonal \varnothing 5-6-8-10-12 mm	867XZNL	M86
7 embout avec entraînement hexagonal \varnothing T20-T25-T30-T40-T45-T50-T55	867TX	M86
6 embout avec entraînement hexagonal \varnothing T25-T30-T40-T45-T50-T55	867TXL	M86
7 Embout avec entraînement hexagonal Tamper Resistant Torx® \varnothing T20-T25-T30-T40-T45-T50-T55	867RTX	M86
1 douille porte-embouts pour 867	867/1	M86
1 douille porte-embouts pour 867	867/2	M86
1 douille porte-embouts	895/1	M100
1 douille porte-embouts	895/3	M100
1 douille porte-embouts	895/6	M100
13 douilles 6 pans avec carré conducteur femelle 1/4" \varnothing 4-4,5-5-5,5-6-7-8-9-10-11-12-13-14 mm	900	M100
9 douille 6 pans série longue \varnothing 5-6-7-8-9-10-11-12-13 mm	900L	M100
5 douilles tournevis pour vis 6 pans creux carré femelle 1/4" \varnothing 3-4-5-6-7 mm	900ME	M100
4 douille tournevis pour vis à fente \bullet 0,8x4-1x5,5-1,2x6,5-1,2x8 mm	900LP	M100
4 douille tournevis pour vis Phillips® \oplus PH1-PH2-PH3-PH4	900PH	M100
7 douille tournevis pour vis Torx® \varnothing T10-T15-T20-T25-T27-T30-T40	900TX	M100
1 rallonge - 1/4" 50 mm	900/20	M100
1 rallonge - 1/4" 100 mm	900/20L	M100
1 rallonge - 1/4" 150 mm	900/21	M100
1 cardan avec carrés mâle et femelle 1/4"	900/25	M100
1 poignée emmanchée avec carré mâle 1/4"	900BG/30	M100
1 poignée coulissante avec carré mâle 1/4"	900/42	M100
1 cliquet réversible avec carré mâle 1/4" \oplus	900/55	M100
21 douilles 6 pans avec carré conducteur femelle 1/2" \varnothing 8-10-11-12-13-14-15-16-17-18-19-20-21-22-23-24-26-27-28-30-32 mm	920A	M100
1 réducteur carré femelle 1/2" et mâle 3/8"	920/15	M100
1 cardan 1/2"	920/25	M100
1 rallonge angulaire - 1/2" 125 mm	920AN/125	M100
1 rallonge angulaire - 1/2" 250 mm	920AN/250	M100
1 poignée coulissante 1/2"	920/42	M100
1 cliquet réversible 1/2" \oplus	920/55	M100
8 douilles pour écrous à empreinte Torx®, 1/2" \varnothing 10-12-14-16-18-20-22-24 mm	920FTX	M100
11 douille 6 pans série longue \varnothing 10-12-13-14-15-16-17-18-19-21-22	920AL	M100
1 Pince coupante diagonale à faible effort de coupe \leq 160 mm	1084BM	M136
1 pince à becs demi-ronds longs \equiv 180 mm	1150BM	M136
1 Pince à becs demi-ronds longs \bullet 160 mm	1166BM	M136
6 tournevis pour vis à fente \bullet 2,5x50-3x75-4x100-5,5x125-6,5x150-8x200 mm	1201E	M213
1 tournevis à lame courte pour vis à fente \bullet 4x30 mm	1201EN	M213
4 tournevis pour vis Phillips® \oplus PH0x60-PH1x80-PH2x100-PH3x150 mm	1202E	M213
1 tournevis à lame courte pour vis Phillips® \oplus PH1X30 mm	1202EN	M213
12 tournevis pour vis Torx® \varnothing T6-T7-T8-T9-T10-T15-T20-T25-T27-T30-T40-T45	1207E/TX	M213
1 tournevis détecteur de tension \bullet	1253	M213
2 burins nervurés 100-200 mm	35	M234
1 marteau de mécanicien 300 g	1370	M234
1 marteau de mécanicien \varnothing 35 mm	1390	M234

CHF

5988U/7M

2,920.00 059881019

Composition conseillée avec RSC23T - RSC24 - RSC24A - RSC24AXL - RSC24L - RSC24L-CAB - RSC28 - C37 - C39 - C39SM - C39MD - RSC55 - C59



5915VU/0

Composition de 35 outils

► Maintenance générale

Quantité/Description

- 1 pointeau 4 mm
- 1 burins nervurés 125 mm
- 8 clés à fourches 6x7-8x9-10x11-12x13-14x15-16x17-18x19-20x22 mm
- 7 Clé mâle 6 pans \odot 1,5-2-2,5-3-4-5-6 mm
- 1 Clé à molette à ouverture graduée, chromée 150 mm
- 1 Pince multiprise entrepassée 250 mm
- 1 pince coupante diagonale, branches gainées avec double couche de PVC antidérapant, finition industrielle \nless 160 mm
- 1 ciseaux d'électricien
- 1 pince universelle, branches gainées avec double couche de PVC antidérapant, modèle grande capacité, finition industrielle \equiv 180 mm
- 1 pince à becs demi-ronds longs striés, branches gainées avec double couche de PVC antidérapant, finition industrielle \bullet 160 mm
- 4 tournevis pour vis à fente \bullet 3x75-4x100-5,5x100-6,5x150 mm
- 3 tournevis pour vis Phillips® \oplus PH0x60-PH1x80-PH2x100 mm
- 1 marteau de mécanicien 300 g
- 1 mètre à ruban 3 m
- 1 cutter à lame sécable 18 mm avec lames 18 mm
- 1 couteau de survie auto
- 1 torche LED à haute luminosité, en aluminium anodisé renforcé, jusqu'à 500 Lumens

Réf. Beta

- 32
- 35
- 55
- 96/BGS7
- 111E
- 1048N
- 1082G
- 1128BMX
- 1150G
- 1166G
- 1201E
- 1202E
- 1370
- 1692/3
- 1771
- 1778SOS
- 1833S

CHF



5915VU/0

516.00 059151021

Composition conseillée avec C4 - C5 - C5S - C6T



5915VU/1

Composition de 45 outils

► Maintenance générale

Quantité/Description

- 2 chasse-clous \varnothing 2-3 mm
- 1 pointeau \varnothing 4 mm
- 2 burins plats 125-150 mm
- 1 bédanes 150 mm
- 14 clés mixtes 6÷14 - 17 - 19 - 21 - 22 - 24 mm
- 9 clés mâles 6 pans coudées \odot 1,5 - 2 - 2,5 - 3 - 4 - 5 - 6 - 8 - 10 mm
- 1 Clé à molette à ouverture graduée, chromée 250 mm
- 1 Pince multiprise entrepassée 250 mm
- 1 pince coupante diagonale, branches gainées avec double couche de PVC antidérapant, finition industrielle \nless 160 mm
- 1 ciseaux d'électricien
- 1 pince universelle, branches gainées avec double couche de PVC antidérapant, modèle grande capacité, finition industrielle \equiv 180 mm
- 1 pince à becs demi-ronds longs striés, branches gainées avec double couche de PVC antidérapant, finition industrielle \bullet 160 mm
- 4 tournevis pour vis à fente \bullet 3x75 - 4x100 - 5,5x100 - 6,5x150 mm
- 3 tournevis pour vis Phillips® \oplus PH0x60 - PH1x80 - PH2x100 mm
- 1 marteau de mécanicien 300 g
- 1 mètre à ruban 5 m
- 1 cutter à lame sécable 18 mm avec lames

Réf. Beta

- 30
- 32
- 34
- 36
- 42
- 96/SC9
- 111E
- 1048N
- 1082G
- 1128BMX
- 1150G
- 1166G
- 1201E
- 1202E
- 1370
- 1692
- 1771

CHF



5915VU/1

625.00 059151024

Composition conseillée avec C8 - C9 - C10 - C10S - C11 - CP15 - CP15L - C16 - CP17 - CP17L - C18



5915VU/2

Composition de 49 outils

► Maintenance générale

Quantité/Description

- 8 clés à fourches 6x7 - 8x9 - 10x11 - 12x13 - 14x15
16x17 - 18x19 - 20x22 mm
- 9 clés mâles 6 pans coudées \odot 1,5 - 2 - 2,5 - 3 - 4 - 5 - 6 - 8 - 10 mm
- 13 douilles 6 pans avec carré conducteur femelle 1/4" \odot 4 - 4,5 - 5 - 5,5 - 6 - 7 - 8 - 9 - 10 - 11 - 12 - 13 - 14 mm
- 1 rallonge - 1/4" 150 mm
- 1 cardan avec carrés mâle et femelle 1/4"
- 1 poignée emmanchée avec carré mâle 1/4"
- 1 poignée coulissante avec carré mâle 1/4"
- 1 cliquet réversible avec carré mâle 1/4" \otimes
- 1 Pince multiprise entrepassée 250 mm
- 1 ciseaux d'électricien
- 1 pince universelle, branches gainées avec double couche de PVC antidérapant, modèle grande capacité, finition industrielle \equiv 180 mm
- 4 tournevis pour vis à fente \bullet 3x75 - 4x100 - 5,5x150 - 6,5x150 mm
- 3 tournevis pour vis Phillips® \oplus PH0x60 - PH1x80 - PH2x100 mm
- 1 marteau de mécanicien 300 g
- 1 mètre à ruban 3 m
- 1 burette plastique 30 cc
- 1 cutter à lame sécable 18 mm avec lames 18 mm

Réf. Beta
55/B8N
96/SC9
900
900/21
900/25
900BG/30
900/42
900/55
1048N
1128BMX
1150G
1201E
1202E
1370
1692
1755
1771

CHF

5915VU/2 544.00 059151027

Composition conseillée avec C7 - CP15 - C20 - C20L



5915VU/3

Composition de 74 outils

► Maintenance générale

Quantité/Description

- 1 chasse-goupilles \varnothing 4 mm
- 1 pointeau \varnothing 4 mm
- 1 burins plats 150 mm
- 14 clés mixtes 6-7-8-10-11-12-13-14-15-16-17-19-22-24 mm
- 9 clés mâles 6 pans coudées \odot 1,5+10 mm
- 3 clés mâles 6 pans à poignée en T \odot 4 - 5 - 6 mm
- 1 Clé à molette à ouverture graduée, chromée 250 mm
- 13 douilles 6 pans avec carré conducteur femelle 1/2" \odot 8+17 - 19 - 22 - 24 mm
- 1 rallonge - 1/2" 125 mm
- 1 rallonge - 1/2" 255 mm
- 1 cardan 1/2"
- 1 poignée coulissante 1/2"
- 1 cliquet réversible 1/2" \otimes
- 8 clés en tube droite 6 pans, série légère 6x7 - 8x9 - 10x11 - 12x13 - 14x15 - 16x17 - 18x19 - 20x22 mm
- 2 broches pour articles 930 - 935
- 1 Pince multiprise entrepassée 250 mm
- 1 pince - étau à becs droits 240 mm
- 1 pince coupante diagonale à faible effort de coupe, branches gainées avec double couche de PVC antidérapant, finition industrielle \equiv 160 mm
- 1 ciseaux d'électricien
- 1 pince universelle, branches gainées avec double couche de PVC antidérapant, modèle grande capacité, finition industrielle \equiv 180 mm
- 1 pince à becs demi-ronds longs striés, branches gainées avec double couche de PVC antidérapant, finition industrielle \bullet 160 mm
- 4 tournevis pour vis à fente \bullet 3x75 - 4x100 - 5,5x150 - 6,5x150 mm
- 3 tournevis pour vis Phillips® \oplus PH0x60 - PH1x80 - PH2x100 mm
- 1 marteau de mécanicien 400 g
- 1 mètre à ruban 5 m
- 1 monture de scie à métaux
- 1 burette plastique 150 cc
- 1 cutter à lame sécable 18 mm avec lames

Réf. Beta
31
32
34
42
96/SC9
96T
111E
920A
920/21
920/22
920/25
920/42
920/55
935
940
1048VN
1052
1084G
1128BMX
1150G
1166G
1201E
1202E
1370
1692
1726
1755
1771

CHF

5915VU/3 1,157.00 059151028

Composition conseillée avec C7 - C9 - C10 - C10S - C11 - CP15L - C16 - CP17 - CP17L - C19 - C19L - C20 - C20L



5915VU/4

Composition de 80 outils

► Maintenance générale

Quantité/Description

- 1 chasse-goupilles Ø 4 mm
- 1 pointeau Ø 4 mm
- 1 burins plats 150 mm
- 15 clés mixtes 6-7-8-9-10-11-12-13-14-15-16-17-19-22-24 mm
- 9 clés mâles 6 pans coudées ⌀ 1,5+10 mm
- 1 Clé à molette à ouverture graduée, chromée 250 mm
- 13 douilles 6 pans avec carré conducteur femelle 1/2" ⌀ 8-17 - 19 - 22 - 24 mm
- 1 rallonge - 1/2" 255 mm
- 1 cardan 1/2"
- 1 poignée coulissante 1/2"
- 1 cliquet réversible 1/2" Ⓞ
- 17 clés à pipe débouchées 6 et 12 pans gros effort 6+22 mm
- 1 Pince multiprise entrepassée 250 mm
- 1 pince - étau à becs droits 240 mm
- 1 pince coupante diagonale à faible effort de coupe, branchées gainées confort bi-matériaux, finition industrielle ⚡ 160 mm
- 1 ciseaux d'électricien
- 1 pince universelle, branches gainées confort bi-matériaux, modèle grande capacité, finition industrielle = 180 mm
- 1 pince à becs demi-ronds longs striés, branches gainées confort bi-matériaux, finition industrielle ● 160 mm
- 4 tournevis pour vis à fente ● 3x75 - 4x100 - 5,5x150 - 6,5x150 mm
- 3 tournevis pour vis Phillips® Ⓞ PH0x60 - PH1x80 - PH2x100 mm
- 1 marteau de mécanicien tête rivoir 32 mm
- 1 mètre à ruban 5 m
- 1 monture de scie à métaux
- 1 burette plastique 150 cc
- 1 cutter à lame sécable 18 mm avec lames

Réf. Beta

- 31
- 32
- 34
- 42
- 96/SC9
- 111E
- 920A
- 920/22
- 920/25
- 920/42
- 920/55
- 932/S17
- 1048N
- 1052
- 1084GBM
- 1128BMX
- 1150GBM
- 1166GBM
- 1201E
- 1202E
- 1370F
- 1692
- 1726
- 1755
- 1771

CHF



5915VU/4

1,500.00 059151045

Composition conseillée avec C20 - C20L



5915VU/5

Composition de 111 outils

► Maintenance générale

Quantité/Description

- 1 chasse-goupilles Ø 4 mm
- 1 pointeau Ø 4 mm
- 1 burins plats 150 mm
- 17 clés mixtes 6-7-8-9-10-11-12-13-14-15-16-17-18-19-20-21-22 mm
- 8 clés à fourches 6x7-8x9-10x11-12x13-14x15-16x17-18x19-20x22 mm
- 9 clés mâles 6 pans coudées à tête sphérique ⌀
- 1 Clé à molette à ouverture graduée, chromée 250 mm
- 39 11 douilles 6 pans, 20 embouts pour visseuses et 8 accessoires
- 13 11 douilles et 2 accessoires
- 1 Pince multiprise entrepassée 250 mm
- 1 pince - étau à becs droits 240 mm
- 1 pince coupante diagonale, branchées gainées avec double couche de PVC antidérapant, finition industrielle ⚡ 160 mm
- 1 Tenaille type russe 220 mm
- 1 ciseaux d'électricien
- 1 pince universelle, branches gainées avec double couche de PVC antidérapant, modèle grande capacité, finition industrielle = 180 mm
- 1 pince à becs demi-ronds longs striés, branches gainées avec double couche de PVC antidérapant, finition industrielle ● 160 mm
- 4 tournevis pour vis à fente ● 3x75 - 4x100 - 5,5x100 - 6,5x150 mm
- 3 tournevis pour vis Phillips® Ⓞ PH0x60 - PH1x80 - PH2x100 mm
- 1 marteau de mécanicien 300 g
- 1 marteau de mécanicien Ø 35 mm
- 1 mètre à ruban 3 m
- 1 limes demi-douces
- 1 monture de scie à métaux 440 mm
- 1 cutter à lame sécable 18 mm avec lames 18 mm
- 1 torche LED d'inspection, en aluminium anodisé renforcé

Réf. Beta

- 31
- 32
- 34
- 42
- 55/S8
- 96BPC/SC9
- 111E
- 900/C11
- 920A/C11
- 1048N
- 1052
- 1082G
- 1098
- 1128BMX
- 1150G
- 1166G
- 1201E
- 1202E
- 1370
- 1390
- 1692/3
- 1719BMA8/M
- 1726
- 1771BM
- 1833XS/2

CHF



5915VU/5

1,470.00 059151046

Composition conseillée avec C12 - C41S - C41H - C42S - C42H

VP-LS

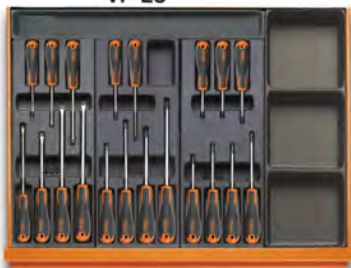

T211 T213 T216 VP3-SC

VP-LS



T145 T153 T137 VP3-SC

VP-LD



T85

VP-LD



T234 T289

VP-LS



T80 T239 VP3-SC

VP-LS



T01

T33 VP3-SC

VP-LD



T68 T236

VP-LD



T50

5938U/2T

Composition de 210 outils en plateaux thermoformés rigides en ABS

► Maintenance générale

Quantité/Description

- 7 tournevis pour vis à fente ● 2,5x50 - 3x75 - 3,5x100 - 4x125
5,5x100 - 5,5x150 - 6,5x150 mm
- 6 tournevis pour vis Phillips® ⊕ PH0x60-PH1x80-PH1x120-PH2x100-PH2x150-PH3x150 mm
- 7 tournevis pour vis Torx® ⊖ T6-T7-T8-T9-T10-T15-T20
- 1 pinces pour circlips intérieurs à becs droits ○ 180 mm
- 1 pinces pour circlips intérieurs à becs coudés ○ 170 mm
- 1 pinces pour circlips extérieurs à becs droits ● 175 mm
- 1 pinces pour circlips extérieurs à becs coudés ● 175 mm
- 1 Pince multiprise entrecroisée 250 mm
- 1 pince - étau à becs droits 240 mm
- 1 Pince coupante diagonale à faible effort de coupe < 160 mm
- 1 pince à becs demi-ronds longs = 180 mm
- 1 Pince à becs demi-ronds longs ● 160 mm
- 1 clé à cliquet réversible porte-embouts 1/4x5/16
- 13 douilles 6 pans avec carré conducteur femelle 1/4" ○ 4-4,5-5-5,5-6-7-8-9-10-11-12-13-14 mm
- 1 cliquet réversible avec carré mâle 1/4" ⊕ 125 mm
- 1 poignée coulissante avec carré mâle 1/4" 115 mm
- 1 poignée emmanchée avec carré mâle 1/4" 176 mm
- 1 cardan avec carrés mâle et femelle 1/4" 41 mm
- 1 rallonge - 1/4" 150 mm
- 1 Poignée porte-embouts à bague de déverrouillage rapide 230 mm
- 5 embout pour visseuses pour vis Spanner ⊕ 4-6-8-10-12 mm
- 8 embout pour visseuses pour vis Torq-Set® ⊕ 0-1-2-3-4-5-6-8 mm
- 6 embout pour visseuses pour vis Tri-Wing® ⊕ 1-2-3-4-5-6 mm
- 8 embout pour visseuses pour vis à Tamper Resistant Torx®
⊕ T9-T10-T15-T20-T25-T27-T30-T40
- 11 embouts de visseuse pour vis à empreinte Torx®
⊖ T6-T7-T8-T9-T10-T15-T20-T25-T27-T30-T40
- 3 Embout pour visseuses pour vis Pozidriv® - Supadriv® ⊕ PZ1 - PZ2 - PZ3
- 4 Embout pour visseuses pour vis Phillips® ⊕ PH0 - PH1 - PH2 - PH3
- 8 Embout pour visseuses pour vis 6 pans creux ○ 2 - 2,5 - 3 - 4 - 5 - 6 - 8 - 10 mm
- 7 Embout pour visseuses pour vis à fente ● 0,5x3 - 0,6x4,5 - 0,8x5,5 - 1x5,5 - 1,2x6,5 - 1,2x8 - 1,6x8 mm
- 2 burins nervurés 100 - 200 mm
- 1 marteau de mécanicien 300 g
- 1 marteau de mécanicien Ø 35 mm
- 1 mètre à ruban 5 m
- 1 mini - monture de scie à métaux
- 1 burette plastique
- 1 cutter à lame sécable 18 mm avec lames
- 19 douilles 6 pans avec carré conducteur femelle 1/2" ○ 10 - 11 - 12+19 - 20 - 21 - 22 - 23 - 24 - 26 - 27 - 30 - 32 mm
- 5 douilles tournevis pour vis 6 pans creux carré femelle 1/2" ○ 5 - 6 - 8 - 10 - 12 mm
- 1 rallonge - 1/2" 125 mm
- 1 rallonge - 1/2" 255 mm
- 1 cardan 1/2"
- 1 poignée coulissante 1/2"
- 1 cliquet réversible 1/2" ⊕
- 1 pointeau Ø 4 mm
- 6 chasse-goupilles gainé confort 2-3-4-5-6-8 mm
- 17 clés mixtes 6-7-8-10-11-12-13-14-16-17-18-19-21-22-24-27-30 mm
- 8 clés à fourches 6x7 - 8x9 - 10x11 - 12x13 - 14x15 - 16x17 - 18x19 - 20x22 mm
- 9 clés mâles 6 pans coudées ○
- 6 clés mâles 6 pans en T ○ 2,5 - 3 - 4 - 5 - 6 - 8 mm
- 5 limes demi-douces 200 mm
- 11 clés mâles 6 pans à poignée en T ○ 2 - 2,5 - 3 - 3,5 - 4 - 4,5 - 5 - 6 mm
- 4 bacs de rangement
- 4 bacs de rangement
- 4 bacs de rangement

Réf. Beta	TR
1201E	T211
1202E	T213
1207E/TX	T216
1032	T145
1034	T145
1036	T145
1038	T145
1048N	T153
1052	T153
1084BM	T137
1150BM	T137
1166BM	T137
194	T85
900	T85
900/55	T85
900/42	T85
900BG/30	T85
900/25	T85
900/21	T85
851SR	T85
861SP	T85
861TQS	T85
861TRW	T85
861RTX	T85
861TX	T85
861PZ	T85
861PH	T85
861PE	T85
861LP	T85
35	T234
1370	T234
1390	T234
1692	T289
1725CR	T289
1755	T289
1771	T289
920A	T80
920ME	T80
920/21	T80
920/22	T80
920/25	T80
920/42	T80
920/55	T80
32	T239
31BM	T239
42	T01
55	T33
96/SC9	T33
951	T68
1719BMA8/S5	T236
96T	T50
VP-3SC	VP-3SC
VP-LS	VP-LS
VP-LD	VP-LD

CHF



3,060.00 059381062

5938U/2T

Composition conseillée avec C38



5957U-P

Composition de 133 outils

► Pour la maintenance générale

Quantité/Description	Réf. Beta
6 chasse-goupilles 2 + 8 mm	31/SP6
6 2 chasse - clous, 1 pointeau, 2 burins plats, 1 bédane, sur présentoir	38/SP6
17 clé mixte 6+22 - 24 - 27 - 30 - 32 mm	42/S17X
12 clés à fourches 6x7 + 30x32 mm	55/S12X
8 clés mâles 6 pans à poignée en T 2 + 10 mm	96T/S8
8 clés mâles coudées pour vis Torx® T9 + T40	97TX/SC8
1 Clé à molette à ouverture graduée, chromée 250 mm	111E
13 douilles 6 pans 1/2" sur rail ⌀ 10 + 22 mm	920A/SB13
8 douilles 6 pans 1/2" sur rail ⌀ 23 + 32 mm	920A/SB8
7 douille tournevis pour vis Phillips®	920LH/SB7
⊕ 1,2x65 - 1,2x8 - 1,6x9 - 2x12mm - PH1-PH2-PH3	
1 pinces pour circlips intérieurs à becs droits ⌀ 180 mm	1032
1 pinces pour circlips intérieurs à becs coudés ⌀ 170 mm	1034
1 pinces pour circlips extérieurs à becs droits ⌀ 175 mm	1036
1 pinces pour circlips extérieurs à becs coudés ⌀ 175 mm	1038
1 Pince multiprise entrepassée 250 mm	1048N
1 pince - étau à becs droits 240 mm	1052
1 cisaille type américain coupe droite 250 mm	1112
1 ciseaux d'électricien	1128BMX
8 tournevis 2,5x50 - 3x75 - 4x100 - 5,5x125 - 6,5x150	1263/D8
PH0 - PH1 - PH2	
2 marteau de mécanicien 300 - 600 g	1370
1 marteau de mécanicien 35	1390
1 mètre à ruban 5 m	1692/5
1 doigt magnétique flexible	1712E/2
1 grattoir feuille de sauge 200 mm	1717A
1 grattoir triangulaire 200 mm	1717B
5 limes demi-douces 200 mm	1719BMA8/S5
1 Burette tôle 200 cc	1751N
1 cutter à lame sécable 18 mm avec lames	1771BM
1 rallonge - 1/2" 125 mm	920/21
1 rallonge - 1/2" 250 mm	920/22
1 cardan 1/2"	920/25
1 poignée coulissante 1/2"	920/42
1 cliquet réversible 1/2" ⊕	920/55
1 pince levier à broche et palette	963
1 Pince coupante diagonale 160 mm	1082BM
1 Pince coupante diagonale à faible effort de coupe 160 mm	1084BM
1 pince coupante frontale articulée, série lourde 180 mm	1092V
1 pince à becs demi-ronds longs 180 mm	1150BM
1 Pince à becs demi-ronds longs 160 mm	1166BM
1 Pince à becs coudés demi-ronds 160 mm	1168BM
2 tournevis pour vis à fente ⌀ 8x200 - 10x200 mm	1260
1 tournevis pour vis Phillips® ⊕ PH3 8x150mm	1262
1 Pied à coulisse	1650
1 montage de scie à métaux 420 mm	1725

CHF

5957U-P

3,210.00 059571004

Composition conseillée avec C57S A - C57S B - C57SP



5958U

Composition de 85 outils

► Maintenance générale

Quantité/Description	Réf. Beta
17 clés mixtes 6+22 mm	42
12 clés mâles 6 pans coudées \varnothing 2+10 mm	96N/SC12
13 douilles 6 pans 1/2" sur rail \varnothing 10+22 mm	920A/SB13
8 douilles 6 pans 1/2" sur rail \varnothing 23+32 mm	920A/SB8
1 rallonge - 1/2" 125 mm	920/21
1 rallonge - 1/2" 255 mm	920/22
1 cardan 1/2"	920/25
1 poignée coulissante 1/2"	920/42
1 cliquet réversible 1/2" \otimes	920/55
1 pinces pour circlips intérieurs à becs droits \varnothing 180 mm	1032
1 pinces pour circlips extérieurs à becs droits \varnothing 175 mm	1036
1 Pince multiprise entrepassée 250 mm	1048N
1 pince - étau à becs droits 240 mm	1052
1 Pince coupante diagonale à faible effort de coupe \leq 160 mm	1084BM
1 ciseaux d'électricien	1128BMX
1 pince à becs demi-ronds longs \equiv 180 mm	1150BM
1 Pince à becs demi-ronds longs \bullet 160 mm	1166BM
7 tournevis pour vis à fente \bullet 3x75 - 3,5x100 - 4x125 5,5x150 - 6,5x150 - 8x200 - 10x200 mm	1260
4 tournevis pour vis Phillips \oplus PH0x60 - PH1x80 PH2x100 - PH3x150 mm	1262/S4
1 marteau de mécanicien 300 g	1370
1 marteau de mécanicien \varnothing 35 mm	1390
1 mètre à ruban 5 m	1692
5 limes demi-douces 200 mm	1719BMA...S5
1 monture de scie à métaux	1725
1 burette plastique 150 cc	1754
1 cutter à lame sécable 18 mm avec lames	1771

CHF



5958U 1,620.00 059581008

Composition conseillée avec C58P - C45 - C55



5990V1

assortiment de 44 outils pour valise COMBO C99V1, plateau en mousse EVA

► Maintenance générale

Quantité/Description

- 9 clés mâles 6 pans coudées à tête sphérique ○
- 1 cutter à lame sécable 18 mm avec lames 18 mm
- 1 Pince multiprise entrepassée 250 mm
- 6 2 poinçons de dérive, 1 poinçon central, 2 ciseaux plats et 1 ciseau à cape en portefeuille enroulable en polyester
- 3 tournevis pour vis à fente ● 3,5x100-5,5x125-6,5x150 mm
- 3 tournevis pour vis Phillips® ⊕ PH0x60-PH1x80-PH2x100 mm
- 1 ciseaux d'électricien
- 16 clés mixtes 6-7-8-9-10-11-12-13-14-15-16-17-18-19-21-22 mm
- 1 mètre à ruban 5 mt
- 1 marteau de mécanicien 300 g
- 1 Pince coupante diagonale ✂ 160 mm
- 1 pince universelle, branches gainées confort bi-matériaux, modèle grande capacité, finition industrielle = 180 mm

Réf. Beta

- 96BPC/SC9 1771
- 1048N 1048N
- 38/B6N 38/B6N
- 1260 1260
- 1128BMX 1128BMX
- 42 42
- 1692/5 1692/5
- 1370 1370
- 1082GBM 1082GBM
- 1150GBM 1150GBM

CHF

5990V1 751.00 059900001

Assortiment recommandé en combinaison avec C99V1



5990V3

assortiment de 116 outils pour valise COMBO C99V3 / 2C, plateau en mousse EVA

► Automobile

Quantité/Description

- 5 clés mâles 6 pans à poignée en T
- 1 Clé à molette à ouverture graduée, chromée 250 mm
- 1 poignée emmanchée avec carré mâle 1/4"
- 1 tournevis détecteur de tension ●
- 1 niveau de poche avec base en "V" magnétique
- 1 torche LED d'inspection, en aluminium anodisé renforcé
- 31 coffret de 31 pièces ● ○ ⊕ ⊗ ⊕ ⊗
- 1 douille porte-embouts
- 12 douilles 6 pans avec carré conducteur femelle 1/4" ○ 4-4,5-5-5,5-6-7-8-9-10-11-12-13 mm
- 1 rallonge - 1/4" 50 mm
- 1 rallonge - 1/4" 100 mm
- 1 poignée coulissante avec carré mâle 1/4"
- 1 cliquet réversible ⊕
- 38 micro-tournevis avec 36 embouts interchangeables de 4 mm et rallonge magnétique, poignée bi-matériau 1256/C36-2
- 1 marteau de mécanicien Ø 35mm
- 1 cardan avec carrés mâle et femelle 1/4"
- 13 douilles 6 pans avec carré conducteur femelle 1/2" ○ 10-11-12-13-14-15-16-17-18-19-20-21-22 mm
- 1 rallonge - 1/2" 125 mm
- 1 rallonge - 1/2" 255 mm
- 1 cardan 1/2"
- 1 poignée coulissante 1/2"
- 1 cliquet réversible 1/2" ⊕

Réf. Beta

- 96T/S5P 96T/S5P
- 111E 111E
- 900BG/30 900BG/30
- 1253 1253
- 1695XS 1695XS
- 1833XS/2 1833XS/2
- 860MIX/A31 860MIX/A31
- 895 895
- 900 900
- 900/20 900/20
- 900/20L 900/20L
- 900/42 900/42
- 900/55Z 900/55Z
- 1256/C36-2 1256/C36-2
- 1390 1390
- 900/25 900/25
- 920A 920A
- 920/21 920/21
- 920/22 920/22
- 920/25 920/25
- 920/42 920/42
- 920/55 920/55

CHF

5990V3 1,080.00 059900003

Assortiment recommandé en combinaison avec C99V3 / 2C

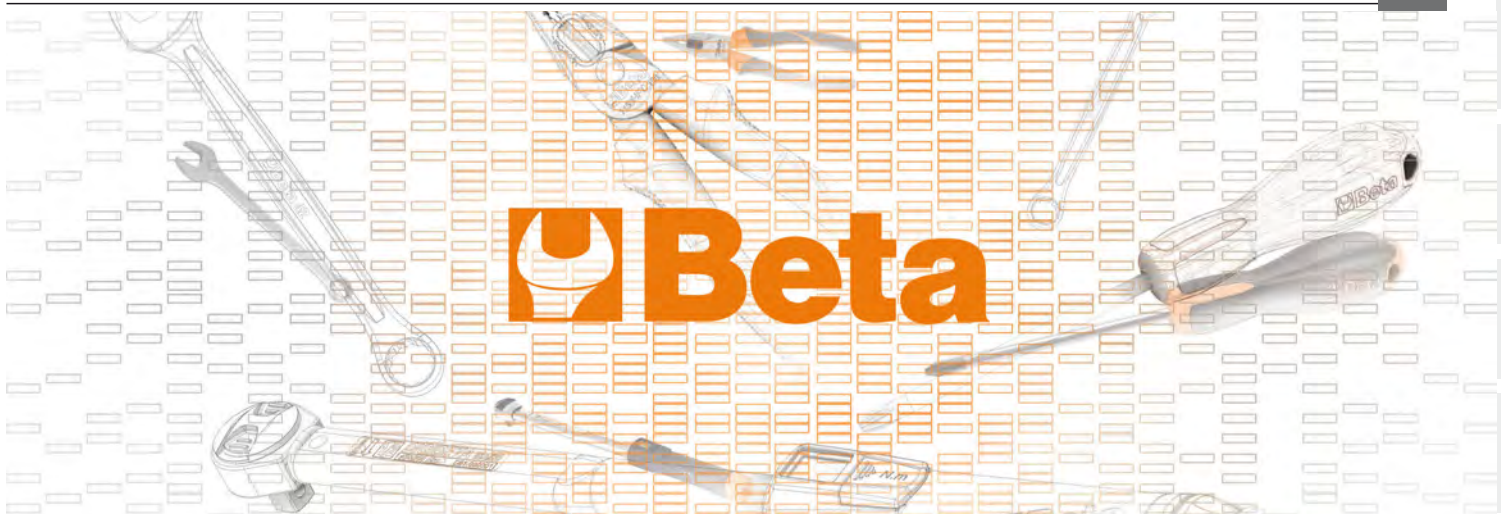



5980U/BIKE

Composition de 90 outils

► Réparation vélos

Quantité/Description	Réf. Beta
5 clés mixtes 8-9-10-13-14 mm	42
9 clé mâle 6 pans coudée à tête sphérique, brunie	96BP/SC9
○ 1,5-2-2,5-3-4-5-6-8-10 mm	
8 clés mâles 6 pans à poignée en T 2-2,5-3-4-5-6-8-10 mm	96T/S8
8 tournevis pour vis Torx® T8-T10-T15-T20-T25-T27-T30-T40	97TTX/S8
1 Clé à molette courte à ouverture majorée, chromée 170 mm	111CM
1 coupe - tubes pour tubes cuivre et alliages légers	334
1 clé dynamométrique à déclenchement avec cliquet réversible 2+10 Nm	605E
13 ○ 4-4,5-5-5,5-6-7-8-9-10-11-12-13-14 mm	900/SB13
1 rallonge - 1/4"	900/21
1 cardan avec carrés mâle et femelle 1/4"	900/25
1 cliquet réversible avec carré mâle 1/4" Ⓞ	900/55
1 pince coupante diagonale, branches gainées avec double couche de PVC antidérapant, finition industrielle 160 mm	1082G
1 ciseaux d'électricien 145 mm	1128BM
1 pince universelle, branches gainées avec double couche de PVC antidérapant, modèle grande capacité, finition industrielle 180 mm	1150G
1 pince à becs demi-ronds longs striés, branches gainées avec double couche de PVC antidérapant, finition industrielle 180 mm	1166G
7 3x75-4x125-5,5x150-6,5x150-PH0x60-PH1x80-PH2x100 mm	1203E/D
1 marteau de mécanicien 300 g	1370
1 marteau de mécanicien Ø 35 mm	1390
1 Pied à coulisse 150 mm	1650
1 mètre à ruban 3 m	1692/3
1 Lime plate demi-douce 200 mm	1719BMA...P
1 Lime demi-ronde demi-douce 200 mm	1719BMA...M
1 lime ronde demi-douce 200 mm	1719BMA...R
1 monture de scie à métaux 300 mm	1725
1 cutter à lame sécable 18 mm avec lames	1771
1 indicateur d'usure de la chaîne 120 mm	3935
1 pince pour fausse maille 170 mm	3937
7 jeu de 7 clés coniques simples 13-14-15-16-17-18-19 mm	3952/S7
1 clé pour pédales 15 mm	3953
1 clé à rayon noire 3,2 mm □	3961 3,2
1 clé à rayon verte 3,3 mm □	3961 3,3
1 clé à rayon rouge 3,5 mm □ 3	3961 3,5
1 clé à rayon professionnelle 3,2 - 4,0 mm □ 3,2 - 4,0 mm	3961U
1 clé fouet démonte-cassette 289 mm	3967
1 levier démonte-pneus 200 mm	3969
3 jeu de 3 leviers démonte-pneus en plastique 113 mm	3969K3
1 levier pour écarter les pastilles des freins à disque 222 mm	3991
1 clé pour redresser les disques des freins 234 mm	3992

CHF



5980U/BIKE 1,935.00 059801040

Composition conseillé en association avec C16 - CP17 - CP17L - C20L

5988H/7M

Composition de 333 outils en en plateaux mousse compacte

► Réparation automobile

Quantité/Description

Réf. Beta	TR
910AL	M125
920AL	M125
920FTX	M125
920PE	M125
920TX	M125
920XZN	M125
42	M25
90	M25
123Q1/4	M25
123Q3/8	M25
123Q1/2	M25
142	M25
96BPC/SC9	M105
895/1	M105
895/3	M105
895/6	M105
900	M105
900L	M105
900LP	M105
900ME	M105
900PH	M105
900TX	M105
900/16	M105
900/...	M105
900/25	M105
900/42	M105
900/55	M105
900BG/30	M105
910A	M105
910/15	M105
910/16	M105
910/21	M105
910/22	M105
910/25	M105
910/42	M105
910/55	M105
920A	M105
920AN	M105
920/15	M105
920/25	M105
920/42	M105
920/55	M105
956E	M105
860MIX/A31	M166
1048N	M166
1082BM	M166
1150BM	M166
1162BM	M166
1290	M166
1290N	M166
1292	M166
1292N	M166
1297TX	M166
31	M231
32	M231
34	M231
36	M231
1370	M231
1712TF	M231
1390	M231
1692	M125
1032	M62
1034	M62
1036	M62
1038	M62
1177BM	M62
1188BM	M62
1257LP	M62
1257PH	M62
977TX	M62
1052	M78
1058	M78
1481PL/A	M78
1481PL/B	M78
1481PL/C	M78
1650	M78
1708/20	M78
1716P	M78
80	M78
920/36A	M78
965	M78
1715	M231
1719BMA8/M	M231
1719BMA8/P	M231
1719BMA8/Q	M231
1719BMA8/R	M231
1719BMA8/T	M231
1737NX	M231



M125



M25



M105



M166



M231



M62



M78

- 13 douille 6 pans série longue ○ 8-9-10-11-12-13-14-15-16-17-19-21-22 mm
- 16 douille 6 pans série longue ○ 10-12-13-14-15-16-17-18-19-21-22-23-24-27-30-32 mm
- 7 douilles pour écrous à empreinte Torx®, 1/2" ○ E12-E14-E16-E18-E20-E22-E24
- 10 Douille tournevis pour vis 6 pans creux ○ 5-6-6L-7-8-8L-10-10L-12-12L mm
- 13 douilles tournevis pour vis à empreinte Torx® ○ T20-T25-T27-T30-T30L-T40-T40L-T45-T50-T50L-T55-T60-T60L
- 8 Douille tournevis pour vis XZN® ○ 5-6-6L-8-8L-10-10L-12L mm
- 18 clés mixtes 6-7-8-9-10-11-12-13-14-15-16-17-18-19-21-22-24-27 mm
- 7 clés polygonales contre - coudées 6x7-8x9-10x11-12x13-14x15-16x17-18x19 mm
- 1 Adaptateur pour douilles 1/4" à déverrouillage rapide, pour clés à cliquet 10 mm
- 1 Adaptateur pour douilles 3/8" à déverrouillage rapide, pour clés à cliquet 13 mm
- 1 Adaptateur pour douilles 1/2" à déverrouillage rapide, pour clés à cliquet 19 mm
- 12 clé mixte à cliquet réversible 8-9-10-11-12-13-14-15-16-17-18-19 mm
- 9 clés mâles 6 pans coudées à tête sphérique ○ 1,5-2-2,5-3-4-5-6-8-10 mm
- 1 douille porte-embouts ○ 1/4-□1/4
- 1 douille porte-embouts ○ 1/4-□3/8
- 1 douille porte-embouts ○ 5/16-□1/2
- 13 douilles 6 pans avec carré conducteur femelle 1/4" ○ 4-4,5-5-5,5-6-7-8-9-10-11-12-13-14 mm
- 9 douille 6 pans série longue ○ 5-6-7-8-9-10-11-12-13 mm
- 4 douille tournevis pour vis à fente ● 0,8x4-1x5,5-1,2x6,51,2x8 mm
- 5 douilles tournevis pour vis 6 pans creux carré femelle 1/4" ○ 3-4-5-6-7 mm
- 4 douille tournevis pour vis Phillips® ○ PH1-PH2-PH3-PH4
- 7 douille tournevis pour vis Torx® ○ T10-T15-T20-T25-T27-T30-T40
- 1 augmentateur carré femelle 1/4" et mâle 3/8" □1/4-■3/8
- 3 rallonge - 1/4" 50-100-150 mm
- 1 cardan avec carrés mâle et femelle 1/4"
- 1 poignée coulissante avec carré mâle 1/4"
- 1 cliquet réversible avec carré mâle 1/4" ⊕
- 1 poignée emmanchée avec carré mâle 1/4"
- 17 douilles 6 pans 3/8" ○ 6-7-8-9-10-11-12-13-14-15-16-17-18-19-20-21-22 mm
- 1 Réducteur carré femelle 3/8" et mâle 1/4" □3/8-■1/4
- 1 Réducteur carré mâle 1/2" et femelle 3/8" □3/8-■1/2
- 1 rallonge - 3/8" 125 mm
- 1 rallonge - 3/8" 250 mm
- 1 cardan 3/8"
- 1 poignée coulissante 3/8"
- 1 cliquet réversible avec carré mâle 3/8" ⊕
- 21 douilles 6 pans avec carré conducteur femelle 1/2" ○ 8-10-11-12-13-4-15-16-17-18-19-20-21-22-23-24-26-27-28-30-32 mm
- 2 rallonge angulaire - 1/2" 125-250 mm
- 1 réducteur carré femelle 1/2" et mâle 3/8" □1/2-■3/8
- 1 cardan 1/2"
- 1 poignée coulissante 1/2"
- 1 cliquet réversible 1/2" ⊕
- 3 douilles pour bougies 3/8" ○ 16-17,8-20,8 mm
- 31 coffret de 31 pièces ● ○ ⊕ ⊙ ⊚ ⊛
- 1 Pince multiprise entrecroisée 250 mm
- 1 Pince coupante diagonale ✂ 160 mm
- 1 pince à becs demi-ronds longs = 180 mm
- 1 Pince à becs plats longs = 160 mm
- 5 tournevis pour vis Phillips® ● 3x75-4x100-5,5x100-6,5x150-8x150 mm
- 1 tournevis à lame courte pour vis à fente ● 6,5x30 mm
- 3 tournevis pour vis Phillips® ○ PH1-PH2-PH3
- 1 tournevis à lame courte pour vis Phillips ○ PH2
- 4 tournevis pour vis Torx® ○ T20-T25-T27-T30
- 6 chasse-goupilles 2-3-4-5-6-8 mm
- 1 pointeau 4 mm
- 3 burins plats 125-150-75 mm
- 1 bédanes 125 mm
- 2 marteau de mécanicien 500-1000 g
- 1 aimant télescopique avec tête flexible
- 1 marteau de mécanicien Ø 35 mm
- 1 mètre à ruban 5 m
- 1 pinces pour circlips intérieurs à becs droits ○ 180 mm
- 1 pinces pour circlips intérieurs à becs coudés ○ 170 mm
- 1 pinces pour circlips extérieurs à becs droits ● 175 mm
- 1 pinces pour circlips extérieurs à becs coudés ● 175 mm
- 1 couteau d'électricien avec dénudeur ● 140 mm
- 1 pince coupante diagonale ✂ 125 mm
- 4 micro-tournevis pour vis à fente ● 2,0-2,5-3,0-3,5 mm
- 2 micro-tournevis pour vis Phillips® ○ 0-00
- 9 tournevis pour vis Torx® ○ T10-T15-T20-T25-T27-T30-T40-T45-T50
- 1 pince - étau à becs droits 240 mm
- 1 pince - étau à becs longs 175 mm
- 1 pinces à durites
- 1 pince à durites
- 1 pince à durites
- 1 Pied à coulisse
- 1 jauge d'épaisseur
- 1 grattoir pour joints
- 7 Clé à douilles articulées 6x7-8x9-10x11-12x13-14x15-16x17-18x19 mm
- 1 poignée articulée carré mâle 1/2
- 1 pince levier plate coudée 450 mm
- 1 miroir d'inspection télescopique 670 mm
- 1 limes demi-douces 200 mm
- 1 limes demi-douces 200 mm
- 1 limes demi-douces 200 mm
- 1 limes demi-douces 200 mm
- 1 limes demi-douces 200 mm
- 1 Brosse à bougies en fils de acier

CHF

5988H/7M 6,620.00 059881087

Composition conseillé en association avec RSC24/8 - RSC24A/8 - RSC24AXL - C37/8 - C39/8 - RSC28 - C59B

5988L/4M

Composition de 273 outils en plateaux mousse compacte

► Réparation automobile

Quantité/Description

- 13 douilles 6 pans avec carré conducteur femelle 1/4" ○ 4-4,5-5-5,5-6-7-8-9-10-11-12-13-14 mm
- 9 douille 6 pans série longue ○ 5-6-7-8-9-10-11-12-13 mm
- 9 clés mâles 6 pans coudées à tête sphérique ○ 1,5-2-2,5-3-4-5-6-8-10 mm
- 1 douille porte-embouts
- 1 douille porte-embouts
- 5 douilles tournevis pour vis 6 pans creux carré femelle 1/4" ○ 3-4-5-6-7 mm
- 4 douille tournevis pour vis à fente ● 0,8x4-1x5,5-1,2x6,5-2x8 mm
- 4 douille tournevis pour vis Phillips® ⚡ PH1-PH2-PH3-PH4
- 7 douille tournevis pour vis Torx® ⚡ T10-T15-T20-T25-T27-T30-T40
- 1 augmentateur carré femelle 1/4" et mâle 3/8" □ 1/4 - ■ 3/8
- 3 rallonge - 1/4" 50-100-150 mm
- 1 cardan avec carrés mâle et femelle 1/4"
- 1 poignée emmanchée avec carré mâle 1/4"
- 1 poignée coulissante avec carré mâle 1/4"
- 1 cliquet réversible avec carré mâle 1/4" ⚡
- 17 douilles 6 pans 3/8" ○ 6-7-8-9-10-11-12-13-14-15-16-17-18-19-20-21-22 mm
- 1 Réducteur carré femelle 3/8" et mâle 1/4" □ 3/8 - ■ 1/4
- 1 Réducteur carré mâle 1/2" et femelle 3/8" □ 3/8 - ■ 1/2
- 1 rallonge - 3/8" 125 mm
- 1 rallonge - 3/8" 250 mm
- 1 cardan 3/8"
- 1 poignée coulissante 3/8"
- 1 cliquet réversible avec carré mâle 3/8" ⚡
- 17 douilles 6 pans avec carré conducteur femelle 1/2" ○ 8-10-11-12-13-14-15-16-17-18-19-20-21-22-23-24-26-27-28-30-32 mm
- 1 réducteur carré femelle 1/2" et mâle 3/8" □ 1/2 - ■ 3/8
- 1 cardan 3/8"
- 2 rallonge angulaire - 1/2" 125 - 250 mm
- 1 poignée coulissante 1/2"
- 1 cliquet réversible 1/2" ⚡
- 3 douilles pour bougies 3/8" ○ 16-17-8-20,8 mm
- 13 douille 6 pans série longue ○ 8-9-10-11-12-13-14-15-16-17-19-21-22 mm
- 10 Douille tournevis pour vis 6 pans creux ○ 5-6-6L-7-8-8L-10-10L-12-12L mm
- 7 douilles pour écrous à empreinte Torx®, 1/2" ⚡ E12-E14-E16-E18-E20-E22-E24
- 13 douilles tournevis pour vis à empreinte Torx® ⚡ T20-T25-T27-T30-T30L-T40-T40L-T45-T50-T50L-T55-T60-T60L
- 8 Douille tournevis pour vis XZN® ○ 5-6-6L-8-8L-10-10L-12L mm
- 16 douille 6 pans série longue ○ 10-12-13-14-15-16-17-18-19-21-22-23-24-27-30-32 mm
- 1 mètre à ruban 5 m
- 18 clés mixtes 6-7-8-9-10-11-12-13-14-15-16-17-18-19-21-22-24-27 mm
- 7 clés polygonales contre - coudées 6x7-8x9-10x11-12x13-14x15-16x17-18x19 mm
- 1 Adaptateur pour douilles 1/4" à déverrouillage rapide, pour clés à cliquet 10 mm
- 1 Adaptateur pour douilles 3/8" à déverrouillage rapide, pour clés à cliquet 13 mm
- 1 Adaptateur pour douilles 1/2" à déverrouillage rapide, pour clés à cliquet 19 mm
- 12 clé mixte à cliquet réversible 8-9-10-11-12-13-14-15-16-17-18-19 mm
- 31 coffret de 31 pièces ● ○ ⚡ ⚡ ⚡
- 1 Pince multiprise entrepassée 250 mm
- 1 Pince coupante diagonale ⚡ 160 mm
- 1 pince à becs demi-ronds longs = 180 mm
- 1 Pince à becs plats longs = 160 mm
- 5 tournevis pour vis Phillips® ● 3x75-4x100-5,5x100-6,5x150-8x150 mm
- 1 tournevis à lame courte pour vis à fente ● 6,5x30 mm
- 3 tournevis pour vis Phillips® ⚡ 4,5x80-6x100-8x150 mm
- 1 tournevis à lame courte pour vis Phillips® ⚡ 6x30 mm
- 4 tournevis pour vis Torx® ⚡ T20-T25-T27-T30

Réf. Beta	TR
900	M105
900L	M105
96BPC/SC9	M105
895/1	M105
895/3	M105
895/6	M105
900ME	M105
900LP	M105
900PH	M105
900TX	M105
900/16	M105
900/...	M105
900/25	M105
900BG/30	M105
900/42	M105
900/55	M105
910A	M105
910/15	M105
910/16	M105
910/21	M105
910/22	M105
910/25	M105
910/42	M105
910/55	M105
920A	M105
920/15	M105
910/25	M105
920AN	M105
920/42	M105
920/55	M105
956E	M105
910AL	M125
920PE	M125
920FTX	M125
920TX	M125
920XZN	M125
920AL	M125
1692/5	M125
42	M25
90	M25
123Q1/4	M25
123Q3/8	M25
123Q1/2	M25
142	M25
860MX/A31	M166
1048N	M166
1082BM	M166
1150BM	M166
1162BM	M166
1290	M166
1290N	M166
1292	M166
1292N	M166
1297TX	M166



M105



M125



M25



M166

CHF

5988L/4M

4,690.00 059881088

Composition conseillée avec RSC24 - RSC24A - RSC24AXL - RSC24L - RSC24L-CAB - C37 - C39 - C39T - C39SM - C39MD - RSC55 - C59

5988U6/M

Composition de 214 outils en plateaux mousse compacte

► Maintenance générale

Quantité/Description

- 22 clés mixtes 6-7-8-9-10-11-12-13-14-15-16-17-18-19-20-21-22-24-27-30-32-36 mm
- 11 clés à fourches 6x7-8x9-10x11-12x13-14x15-16x17-18x19-20x22-21x23-24x27-30x32 mm
- 11 clés polygonales contre - coudées 6x7-8x9-10x11-12x13-14x15-16x17-18x19-20x22-21x23-24x27-30x32 mm
- 9 clés mâles 6 pans coudées à tête sphérique \odot 1,5-2-2,5-3-4-5-6-8-10 mm
- 6 tournevis pour vis à fente \bullet 2,5x50-3x75-4x100-5,5x125-6,5x150-8x200 mm
- 1 tournevis à lame courte pour vis à fente \bullet 4x30 mm
- 4 tournevis pour vis Phillips® \oplus PH0x60-PH1x80-PH2x100-PH3x150 mm
- 1 tournevis à lame courte pour vis Phillips® \oplus PH1x30 mm
- 12 tournevis pour vis Torx® \otimes T6-T7-T8-T9-T10-T15-T20-T25-T27-T30-T40-T45
- 1 tournevis détecteur de tension \bullet
- 3 chasse-clous \emptyset 2-3-4 mm
- 6 chasse-goupilles \emptyset 2-3-4-5-6-8 mm
- 1 pointeau \emptyset 4 mm
- 1 burins plats 150 mm
- 2 burins nervurés 200-250 mm
- 1 bédanes 125 mm
- 1 marteau de mécanicien 500 g
- 1 marteau de mécanicien \emptyset 35 mm
- 1 mètre à ruban 3 m
- 1 aimant télescopique avec tête flexible
- 1 Lime carrée demi-douce 200 mm
- 1 Lime triangulaire demi-douce 200 mm
- 1 Lime plate demi-douce 200 mm
- 1 Lime demi-ronde demi-douce 200 mm
- 1 lime ronde demi-douce 200 mm
- 1 Brosse à bougies en fils de acier
- 1 cutter à lame sécable 18 mm avec lames 18 mm
- 1 pinces pour circlips intérieurs à becs droits \odot 180 mm
- 1 pinces pour circlips intérieurs à becs coudés \odot 170 mm
- 1 pinces pour circlips extérieurs à becs droits \bullet 175 mm
- 1 pinces pour circlips extérieurs à becs coudés \bullet 175 mm
- 1 Pince multiprise entrepassée 250 mm
- 1 pince - étau à becs droits 240 mm
- 1 Pince coupante diagonale \sphericalangle 160 mm
- 1 Tenaille type russe 220 mm
- 1 cisaille type américain coupe droite 250 mm
- 1 ciseaux d'électricien
- 1 pince à becs demi-ronds longs \equiv 180 mm
- 1 Pince à becs demi-ronds longs \bullet 160 mm
- 1 Pince à becs coudés demi-ronds \bullet 160 mm
- 1 douille porte-embouts
- 1 douille porte-embouts
- 1 douille porte-embouts
- 13 douilles 6 pans avec carré conducteur femelle 1/4" \odot 4-4,5-5-5,5-6-7-8-9-10-11-12-13-14 mm
- 9 douille 6 pans série longue \odot 5-6-7-8-9-10-11-12-13 mm
- 5 douilles tournevis pour vis 6 pans creux carré femelle 1/4" \odot 3-4-5-6-7 mm
- 4 douille tournevis pour vis à fente \bullet 0,8x4-1x5,5-1,2x6,5-1,2x8 mm
- 4 douille tournevis pour vis Phillips® \oplus PH1-PH2-PH3-PH4
- 7 douille tournevis pour vis Torx® \otimes T10-T15-T20-T25-T27-T30-T40
- 1 rallonge - 1/4" 50 mm
- 1 rallonge - 1/4" 100 mm
- 1 rallonge - 1/4" 150 mm
- 1 cardan avec carrés mâle et femelle 1/4"
- 1 poignée emmanchée avec carré mâle 1/4"
- 1 poignée coulissante avec carré mâle 1/4"
- 1 cliquet réversible avec carré mâle 1/4" \otimes
- 21 douilles 6 pans avec carré conducteur femelle 1/2" \odot 8-10-11-12-13-14-15-16-17-18-19-20-21-22-23-24-26-27-28-30-32 mm
- 1 réducteur carré femelle 1/2" et mâle 3/8" 125 mm
- 1 cardan 1/2" 250 mm
- 1 rallonge angulaire - 1/2"
- 1 rallonge angulaire - 1/2"
- 1 poignée coulissante 1/2"
- 1 cliquet réversible 1/2" \otimes
- 8 douilles pour écrous à empreinte Torx®, 1/2" \odot 10-12-14-16-18-20-22-24 mm
- 11 douille 6 pans série longue \odot 10-12-13-14-15-16-17-18-19-21-22 mm

Réf. Beta	TR
42	M01
55	M30
90	M30
96BPC/SC9	M30
1201E	M213
1201EN	M213
1202E	M213
1202EN	M213
1207E/TX	M213
1253	M213
30	M230
31	M230
32	M230
34	M230
35	M230
36	M230
1370	M230
1390	M230
1692	M230
1712TF	M230
1719BMA...Q	M230
1719BMA...T	M230
1719BMA...P	M230
1719BMA...M	M230
1719BMA...R	M230
1737NX	M230
1771	M230
1032	M129
1034	M129
1036	M129
1038	M129
1048N	M129
1052	M129
1082BM	M129
1098	M129
1112	M129
1128BM	M129
1150BM	M129
1166BM	M129
1168BM	M129
895/1	M100
895/3	M100
895/6	M100
900	M100
900L	M100
900ME	M100
900LP	M100
900PH	M100
900TX	M100
900/20	M100
900/20L	M100
900/21	M100
900/25	M100
900BG/30	M100
900/42	M100
900/55	M100
920A	M100
920/15	M100
920/25	M100
920AN/125	M100
920AN/250	M100
920/42	M100
920/55	M100
920FTX	M100
920AL	M100



M01



M30

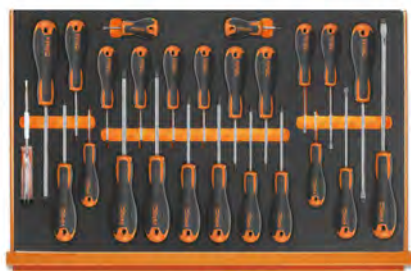

M213



M230



M129



M100

CHF

5988U6/M 3,930.00 059881430

Composition conseillée avec RSC24 à 8 tiroirs - RSC24/A à 8 tiroirs - C37 à 8 tiroirs - C39 à 8 tiroirs RSC24AXL - RSC28 - C39SM - C39MO - C59B - C55

5935ET/1MB

Composition de 96 outils pour coffre C35, en plateaux mousse compacte



MB65



MB64

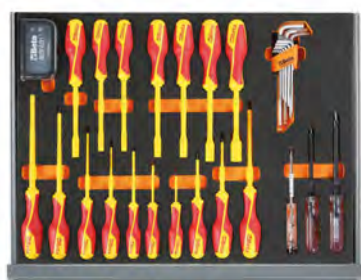

MB63

► Microtechnique

Quantité/Description

- 1 pince - étau à becs droits 240 mm
- 1 marteau de mécanicien 500 g
- 1 marteau de mécanicien Ø 35 mm
- 1 Lime carrée demi-douce 200 mm
- 1 Lime plate demi-douce 200 mm
- 1 Lime triangulaire demi-douce 200 mm
- 1 Lime demi-ronde demi-douce 200 mm
- 1 lime ronde demi-douce 200 mm
- 1 burins nervurés 200 mm
- 1 pinces pour circlips intérieurs à becs droits ⌀ 180 mm
- 1 pinces pour circlips intérieurs à becs coudés ⌀ 170 mm
- 1 pinces pour circlips extérieurs à becs droits ● 175 mm
- 1 pinces pour circlips extérieurs à becs coudés ● 175 mm
- 1 Pince coupante diagonale à faible effort de coupe † 160 mm
- 1 pince à becs demi-ronds longs = 180 mm
- 1 Pince à becs demi-ronds longs ● 160 mm
- 9 clés mâles 6 pans coudées à tête sphérique ○
- 1 tournevis pose - vis à fente ●
- 1 tournevis pose - vis Phillips® ⊕
- 1 tournevis détecteur de tension ●
- 6 clés à douille emmanchées ○ 5,5-6-7-8-10-13 mm
- 4 tournevis pour vis Phillips® 1000V ⊕ PH0x60-PH1x80-PH2x100-PH3x150 mm
- 6 tournevis à lame fraisée pour vis à fente 1000V ● 2,5x75-3x100-4x100-5,5x125-6x150-8x175 mm
- 31 coffret de 31 pièces ● ○ ⊕ ⊕ ⊕ ⊕
- 1 Poignée porte-embouts magnétique isolée ⊕
- 8 clés à fourches 6x7-8x9-10x11-12x13-14x15 16x17-18x19-20x22 mm
- 1 pince multiprise entrepassée 250 mm
- 1 pinces coupantes diagonales 1000V † 140 mm
- 1 Ciseaux d'électricien lames droites avec évaseur
- 1 coupe-câbles avec branches isolées 230 mm
- 1 pinces à dénuder † 160 mm
- 1 pince universelle 1000V = 180 mm
- 1 pinces à becs demi - ronds longs 1000V ● 160 mm
- 1 Pince à becs coudés demi-ronds longs ● 160 mm
- 1 clé à molette 1000V 250 mm
- 1 cutter 1000V
- 1 brucelles à becs coudés 1000V
- 1 pince à cosses pré - isolées

Réf. Beta	TR
1052	MB65
1370	MB65
1390	MB65
1719BMA...Q	MB65
1719BMA...P	MB65
1719BMA...T	MB65
1719BMA...M	MB65
1719BMA...R	MB65
35	MB65
1032	MB65
1034	MB65
1036	MB65
1038	MB65
1084BM	MB65
1150BM	MB65
1166BM	MB65
96BPC/SC9	MB63
1250	MB63
1251	MB63
1253	MB63
943MQ	MB63
1272MQ	MB63
1274MQ	MB63
860MX/A31	MB63
850MQ	MB63
55	MB64
1048MQ	MB64
1082MQ	MB64
1128BSX	MB64
1132MQ	MB64
1142MQ	MB64
1150MQ	MB64
1166MQ	MB64
1168MQ	MB64
110MQ	MB64
1777MQ	MB64
993MQ	MB64
1602	MB64

CHF

5935ET/1MB

2,295.00 059351332

Composition conseillée avec C35

5980ET/A

Composition de 70 outils

► Microtechnique

Quantité/Description	Réf. Beta
1 pointeau Ø 4 m	32
1 burins nervurés 150 mm	35
8 6x7 - 8x9 - 10x11 - 12x13 - 14x15 - 16x17 - 18x19 - 20x22 mm	55/B8N
8 jeu de 8 clés mâles 6 pans, série longue Ø 2÷10 mm	96LC/SC8
1 Clé à molette à ouverture graduée, chromée 200 mm	111E
1 Poignée porte-embouts magnétique isolée	850MQ
10 coffret de 11 pièces	860MIX/A10
1 pince multiprise entrepassée 250 mm	1048MQ
1 Pince coupante diagonale 160 mm	1082BM
1 Ciseaux d'électricien lames droites avec évaseur	1128BSX
1 coupe - câbles 170 mm	1132BM
1 pince à becs demi-ronds longs 180 mm	1150BM
1 Pince à becs demi-ronds longs 160 mm	1166BM
1 Pince à becs coudés demi-ronds 160 mm	1168BM
1 tournevis pose - vis à fente 4x125 mm	1250
1 tournevis pose - vis Phillips PH1x125 mm	1251
1 tournevis détecteur de tension	1253
5 tournevis pour vis à fente 2,5x75 - 3,5x100 - 5,5x125 - 6,5x150 mm	1201E
1 tournevis à lame courte pour vis à fente 4x30 mm	1201EN
4 tournevis pour vis Phillips PH0x60 - PH1x120 - PH2x150 - PH3x150 mm	1202E
1 tournevis à lame courte pour vis Phillips PH2x30 mm	1202EN
4 tournevis pour vis Phillips 1000V PH0x60 - PH1x80 - PH2x100 - PH3x150 mm	1272MQ
5 tournevis à lame fraisée pour vis à fente 1000V 5,5x125 - 3x100 - 4x100 - 6,5x150 - 8x175 mm	1274MQ
1 burin plat de carrossier coupe latérale	1343
1 marteau de mécanicien 300 g	1370
1 marteau de mécanicien Ø 35 mm	1390
1 pince à cosses pré - isolées	1602
1 25 m	BMESB1923NE
1 mètre à ruban 5 m	1692
1 Lime demi-ronde demi-douce 200 mm	1719BMA...M
1 lime ronde demi-douce 200 mm	1719BMA...R
1 monture de scie à métaux	1725
1 couteau d'électricien avec dénudeur	1777BM



CHF



5980ET/A

1,200.00 059801083

Composition conseillée avec C12 - 2028VV - 2032TV - 2032VV

5980ET/B

Composition de 64 outils

► Pour la microtechnique

Quantité/Description

- 3 chasse-goupilles Ø 2 - 3 - 4 mm
- 1 pointeau Ø 4 mm
- 1 burins plats 150 mm
- 8 6x7 - 8x9 - 10x11 - 12x13 - 14x15 - 16x17 - 18x19 - 20x22 mm
- 9 clés mâles 6 pans coudées à tête sphérique ○ 1,5 - 2 - 2,5 - 3 - 4 - 5 - 6 - 8 - 10 mm
- 1 ébavureur à lame 150 mm
- 6 clés a douilles emmanchée 1000V ○ 5,5 - 6 - 7 - 8 - 10 - 13 mm
- 1 pince multiprise entrepassée 250 mm
- 1 pinces coupantes diagonales 1000V ☿ 160 mm
- 1 Ciseaux d'électricien lames droites avec évaseur
- 1 coupe-câbles avec branches isolées 230 mm
- 1 pinces à dénuder ☿ 160 mm
- 1 pince universelle 1000V ≡ 180 mm
- 1 pinces à becs demi - ronds longs 1000V ● 160 mm
- 1 tournevis détecteur de tension ●
- 3 tournevis pour vis Phillips® 1000V ⊕ PH0x60 - PH1x80 - PH2x100 mm
- 4 tournevis à lame fraisée pour vis à fente 1000V ● 3x100 - 4x100 - 5,5x125 - 6,5x150 mm
- 1 marteau de mécanicien 300 g
- 1 marteau de mécanicien Ø 35 mm
- 1 pince à cosses pré - isolées
- 1 régllet flexible 250 mm
- 1 pointe à tracer en carbure 250 mm
- 1 mètre à ruban 5 m
- 1 niveau en aluminium 200 mm
- 1 ciseau d'électricien 10x200 mm
- 1 cordeau à tracer
- 1 miroir d'inspection flexible 600 mm
- 1 limes demi-douces 200 mm
- 1 limes demi-douces 200 mm
- 1 tire - ressorts
- 1 monture de scie à métaux
- 1 pinceau de nettoyage
- 1 pince pour colliers en Nylon
- 1 burette plastique 80 cc
- 100 collier en nylon, couleur noir résistant aux UV 3,6x200 mm
- 100 collier en nylon, couleur noir résistant aux UV 4,8x300 mm
- 1 cutter à lame sécable 18 mm avec lames
- 1 fer à souder bi - avec panne droite pointue 30 W
- 1 torche LED d'inspection, en aluminium anodisé renforcé

Réf. Beta

- 31
- 32
- 34
- 55/BN
- 96BPC/SC9
- 345SB
- 943MQ/S6
- 1048MQ
- 1082MQ
- 1128BSX
- 1132MQ
- 1142MQ
- 1150MQ
- 1166MQ
- 1253
- 1272MQ
- 1274MQ
- 1370
- 1390
- 1602
- 1682
- 1688
- 1692
- 1696
- 1701NE3
- 1705
- 1715FL/A
- 1719BMA8/M
- 1719BMA8/R
- 1723
- 1726BM
- 1738
- 1743
- 1755
- 1748N
- 1748N
- 1771BM
- 1814M
- 1833XS/2

CHF



5980ET/B

1,645.00 059801084

Composition conseillée avec C12 - 2029/VV - 2033P/VV - 2036TV

5980MQ

Composition de 46 outils

► Microtechnique

Quantité/Description

- 7 clés à fourches 1000V 10 - 12 - 13 - 14 - 17 - 19 - 22 mm
- 1 clé à molette 1000V 250 mm
- 6 clés à douille emmanchées ○ 5,5 - 6 - 7 - 8 - 10 - 13 mm
- 4 clés mâles 6 pans en T ○ 4 - 5 - 6 - 8 mm
- 1 brucelles à becs coudés 1000V
- 1 pince multiprise entrepassée 250 mm
- 1 pinces coupantes diagonales 1000V ☿ 160 mm
- 1 ciseaux d'électriciens
- 1 pinces à dénuder ☿ 160 mm
- 1 pince universelle 1000V ≡ 180 mm
- 1 Pince à becs coudés plats longs ≡ 160 mm
- 1 pinces à becs demi - ronds longs 1000V ● 160 mm
- 1 tournevis détecteur de tension ●
- 4 tournevis pour vis Phillips® 1000V ⊕ PH0x60 - PH1x80 - PH2x100 - PH3x150 mm
- 5 tournevis à lame fraisée pour vis à fente 1000V ● 3x100 - 4x100 - 5,5x125 - 6,5x150 - 8x175 mm
- 1 marteau de mécanicien 300 g
- 1 marteau de mécanicien Ø 35 mm
- 1 mètre à ruban 5 m
- 1 200 mm
- 1 mini - scie 1000V
- 2 cutter 1000V
- 1 fer à souder bi - avec panne droite pointue 30 W
- 1 torche LED à haute luminosité, en aluminium anodisé renforcé, jusqu'à 500 Lumens
- 1 testeur combiné de tension et de continuité

Réf. Beta

- 52MQ
- 110MQ
- 943MQ
- 951MQ
- 993MQ
- 1048MQ
- 1082MQ
- 1128MQ
- 1142MQ
- 1150MQ
- 1164MQ
- 1166MQ
- 1253
- 1272MQ
- 1274MQ
- 1370
- 1390
- 1692
- 1701NE3
- 1725MQ
- 1777MQ
- 1814M
- 1833S
- 1847P

CHF



5980MQ

2,225.00 059801257

Composition conseillée avec 2029/VV

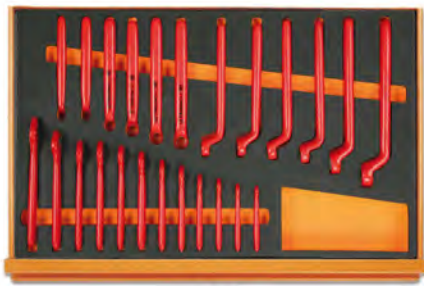

M49



M108



M161

5988 VHB-MQ

Composition de 66 outils en plateau mousse compacte

► Microtechnique

Quantité/Description

- 12 clés à fourches 1000V 7-8-10-11-12-13-14-15-16-17-19-22 mm
- 12 Clé polygonale contre-coudée 7-8-10-11-12-13-14-15-16-17-19-22 mm
- 4 Douille tournevis pour vis 6 pans creux \odot 4-5-6-8 mm
- 11 Douille 12 pans \odot 7-8-10-11-12-13-14-15-16-17-19 mm
- 6 Douille tournevis pour vis Torx® \odot T15-T20-T25-T27-T30-T40
- 2 Douille tournevis pour vis XZN® \odot 8-10 mm
- 1 Rallonge carrés mâle et femelle 3/8" 125 mm
- 1 Rallonge carrés mâle et femelle 3/8" 250 mm
- 1 Poignée à béquille à cardan carré mâle 3/8"
- 1 Cliquet réversible carré mâle 3/8"
- 1 ciseaux d'électriciens
- 1 pince multiprise entrepassée 250 mm
- 1 pinces coupantes diagonales 1000V ∇ 160 mm
- 1 pince universelle 1000V \equiv 180 mm
- 1 Pince à becs plats longs striés \equiv 160 mm
- 1 Pince à becs coudés plats longs \equiv 160 mm
- 4 tournevis pour vis Phillips® 1000V \oplus PH0x60 - PH1x80 - PH2x100 - PH3x150 mm
- 4 tournevis à lame fraisée pour vis à fente 1000V \bullet 2,5x75 - 3x100 - 4x100 - 5,5x125 mm
- 1 Couteau d'électricien avec dénudeur isolé

Réf. Beta	TR
52MQ	M49
89MQ	M49
910MQ/PE	M108
910MQ/B	M108
910MQ/TX	M108
910MQ/XZN	M108
910MQ/21	M108
910MQ/22	M108
910MQ/T	M108
910MQ/55	M108
1128MQ	M161
1048MQ	M161
1082MQ	M161
1150MQ	M161
1162MQ	M161
1164MQ	M161
1272MQ	M161
1274MQ	M161
1777MQ/U	M161

CHF

5988 VHB-MQ 3,660.00 059880300

Composition conseillée avec RSC23T - RSC24 - RSC24A - RSC24AXL - RSC24L - RSC24L-CAB
RSC28 - C37 - C39 - C39SM - C39MD - C39T - RSC51 - RSC55 - RSC50 - C59

5980EL/A

Composition de 57 outils

► Électronique

Quantité/Description

- 13 4+14 mm
- 9 clés mâles 6 pans coudées \odot 1,5+10 mm
- 1 brucelles à becs coudés 130 mm
- 1 brucelles à becs droits avec guide 150 mm
- 1 brucelles à becs droits auto - serrants, pointes larges 155 mm
- 1 ciseaux d'électricien
- 1 pince à dénuder ∇ 160 mm
- 1 Pince à becs demi-ronds longs \bullet 160 mm
- 1 pince à becs plats longs \equiv
- 1 pince de précision à becs coudés demi - ronds longs \bullet
- 1 pince universelle \bullet
- 1 pince coupante diagonale avec becs effilés coupe à ras ζ
- 1 pince coupante diagonale ∇
- 1 tournevis pose - vis à fente \bullet 4x125 mm
- 1 tournevis pose - vis Phillips® \oplus PH0x125 mm
- 8 micro-tournevis
- 1 marteau de mécanicien 200 g
- 1 mètre à ruban 5 m
- 1 miroir d'inspection télescopique
- 3 limes
- 1 tire - ressorts
- 1 pinceau de nettoyage
- 1 Burette stylo
- 1 cutter à lame sécable 18 mm avec lames
- 1 pince à anneaux auto-bloquante, becs arrondis striés, en acier inoxydable
- 1 fer à souder bi - avec panne droite pointue 25 W
- 1 pompe à dessouder
- 1 torche LED d'inspection, en aluminium anodisé renforcé

Réf. Beta	TR
73/B13N	
96N/SC9	
991	
992	
998	
1128BMX	
1142BM	
1166BM	
1172BM	
1178BM/P	
1178BM	
1185BM	
1188BM	
1250	
1251	
1257LPH/S8	
1370	
1692	
1715	
1720/S3	
1723	
1738	
1756	
1771	
1002	
1814M	
1830T	
1833XS/2	

CHF

5980EL/A 1,179.00 059801081

Composition conseillée avec 2032TV - 2028/VV - 2033P/VV

5980EL/B

Composition de 98 outils

► Électronique

Quantité/Description

Quantité/Description	Réf. Beta
13 4÷14 mm	73/B13N
9 clés mâles 6 pans coudées \varnothing 1,5÷10 mm	96/SC9
8 clés mâles pour vis à empreinte Torx® T9 - T10 - T15 - T20 - T25 - T27 - T30 - T40	97TX/BG8
1 Clé à molette à ouverture graduée, chromée 150 mm	111E
18 13 douilles 6 pans et 5 accessoires 1/4"	900/C13-5
1 brucelles à becs droits pointes fines 130 mm	990
1 brucelles à becs coudés 130 mm	991
1 brucelles à becs courts pointes lisses finition semi - polie 120 mm	999A
1 ciseaux d'électricien	1128BMX
1 pince à dénuder frontale autoréglable 170 mm	1149F
1 pince à becs demi-ronds longs \equiv 180 mm	1150BM
1 pince à becs plats longs \equiv 140 mm	1172BM
1 couteau d'électricien avec dénudeur \bullet 140 mm	1177BM
1 pince de précision à becs coudés demi - ronds longs \bullet 140 mm	1178BM/P
1 pince coupante diagonale de précision à becs arrondis, coupe à ras \sphericalangle 120 mm	1184BM
1 pince coupante diagonale de précision à becs effilés, coupe à ras \sphericalangle 120 mm	1186BM
1 pince coupante frontale de précision tête inclinée, coupe à ras \sphericalangle	1191BM
8 micro-tournevis	1257LPH/S8
1 tournevis détecteur de tension \bullet	1253
1 tournevis à lame courte pour vis à fente \bullet 6,5x30 mm	1290N
3 tournevis pour vis Phillips® PH0x60 - PH1x80 - PH2x100 mm	1292
2 tournevis à lame courte pour vis Phillips® PH1x30 - PH2x30 mm	1292N
5 tournevis à lame fraisée pour vis à fente \bullet 2,5x60 - 3x75 - 4x100 - 5x125 - 6,5x150 mm	1294
1 marteau de mécanicien 200 g	1370
1 réglet flexible 150 mm	1682
1 pointe à tracer en carbure 220 mm	1688
1 mètre à ruban 5 m	1692
1 miroir d'inspection télescopique 670 mm	1715
1 Lime \bullet	1720R
1 Lime \blacktriangle	1720T
1 Lime \blacksquare	1720P
1 tire - ressorts	1723
1 pinceau de nettoyage	1738
1 Burette stylo	1756
1 cutter à lame sécable 18 mm avec lames	1771BM
1 couteau d'électricien avec dénudeur	1777BM
1 pince à anneaux auto-bloquante, becs arrondis striés, en acier inoxydable	1002
1 fer à souder bi - avec panne droite pointue 25W	1814M
1 pompe à dessouder	1830T
1 torche LED d'inspection, en aluminium anodisé renforcé	1833XS/2



CHF



5980EL/B

1,660.00 059801082

Composition conseillée avec 2029/VV - 2033P/VV - 2036TV

5980ID

Composition de 35 outils

► Plomberie

Quantité/Description

- 1 burins plats 150 mm
- 1 burins nervurés 200 mm
- 12 clés à fourches 6x7 - 8x9 - 10x11 - 12x13 - 14x15 - 16x17
18x19 - 20x22 - 21x23 - 24x27 - 25x28 - 30x32 mm
- 1 Clé à molette à ouverture graduée, chromée 250 mm
- 1 coupe - tubes pour tubes cuivre et alliages légers Ø 3+30 mm
- 1 clé serre - tube modèle suédois tête inclinée à 45° 320 mm
- 1 pince - étai à becs droits 240 mm
- 1 cisaille type américain coupe droite 300 mm
- 1 ciseaux d'électricien
- 1 pince universelle, branches gainées confort bi-matières, modèle grande capacité, finition industrielle = 180 mm
- 4 tournevis pour vis à fente ● 3x75 - 4x100 - 5,5x150 - 8x150 mm
- 2 tournevis pour vis Phillips® ⚙ PH1x80 - PH2x100 mm
- 1 marteau de mécanicien 300 g
- 1 mètre pliant en fibre 2 m
- 1 mètre à ruban 5 m
- 1 niveau en aluminium 200 mm
- 1 Lime demi-ronde demi-douce 200 mm
- 1 monture de scie à métaux
- 1 Brosse à bougies en fils de acier
- 1 Pince multiprise entrepassée 250 mm

Réf. Beta

- 34
- 35
- 55/S12X
- 111E
- 334
- 374
- 1052
- 1112
- 1128BMX
- 1150GBM
- 1201E
- 1202E
- 1370
- 1690F
- 1692
- 1696
- 1719BMA...M
- 1725
- 1737NX
- 1048N



CHF

5980ID 754.00 059801085

Composition conseillée avec 2009N/VV

5902MT

Composition de 106 outils pour matériel agricole et engins de chantier

► Réparation automobile

Quantité/Description

- 2 chasse-clous Ø 3 - 4 mm
- 2 chasse-goupilles Ø 6 - 8 mm
- 1 pointeau Ø 4 mm
- 2 burins nervurés 150 - 200 mm
- 18 clés mixtes 6+14 - 17 - 19 - 22 - 24 - 27 - 30 - 32 - 36 - 41 mm
- 10 clés polygonales contre - coudées 6x7 - 8x9 - 10x11 - 12x13 - 14x15
16x17 - 18x19 - 20x22 - 24x27 - 30x32 mm
- 10 clés mâles 6 pans coudées ○ 1,5+12 mm
- 17 douilles 6 pans avec carré conducteur femelle 1/2" ○ 10+22 - 24 - 27 - 30 - 32 mm
- 1 rallonge - 1/2" 125 mm
- 1 rallonge - 1/2" 255 mm
- 1 cardan 1/2"
- 1 poignée coulissante 1/2"
- 1 cliquet réversible à glissières 1/2" Ⓢ
- 11 douilles 6 pans 3/4" ○ 22 - 24 - 27 - 30 - 32 - 36 - 41 - 46 - 50 - 55 - 60 mm
- 1 rallonge - 3/4" 200 mm
- 1 poignée articulée 3/4"
- 1 poignée coulissante 3/4"
- 1 cliquet réversible 3/4" Ⓢ
- 1 pince levier à broche et à bec
- 1 Pince multiprise entrepassée 250 mm
- 1 pince-étai à becs arrondis
- 1 pince coupante diagonale à faible effort de coupe, branchées gainées confort bi-matières, finition industrielle ≡ 160 mm
- 1 ciseaux d'électricien
- 1 pince universelle, branches gainées confort bi-matières, modèle grande capacité, finition industrielle = 180 mm
- 1 pince à becs demi-ronds longs striés, branches gainées confort bi-matières, finition industrielle ● 160 mm
- 4 tournevis avec 6 pans pour vis à fente ● 6,5x150 - 8x175 - 10x200 - 12x250 mm
- 3 tournevis avec 6 pans pour vis Phillips® ⚙ PH2x150 - PH3x175 - PH4x200 mm
- 1 marteau de mécanicien modèle américain 900 g
- 1 marteau de mécanicien Ø 35 mm
- 1 jauge d'épaisseur
- 1 grattoir triangulaire 200 mm
- 5 limes demi-douces 200 mm
- 1 monture de scie à métaux

Réf. Beta

- 30
- 31
- 32
- 35
- 42
- 90
- 96N/B10
- 920A
- 920/21
- 920/22
- 920/25
- 920/42
- 920/50
- 928A
- 928/21
- 928/36A
- 928/42
- 928/55
- 964
- 1048N
- 1055
- 1084GBM
- 1128BMX
- 1150GBM
- 1166GBM
- 1260E
- 1262E
- 1377
- 1390
- 1708/20
- 1717B
- 1719BMA...S5
- 1725



CHF

5902MT 2,760.00 059021053

Composition conseillée avec RSC22 - RSC23 - RSC23C - C39T

5902MT/AS

Composition de 99 outils pour engins de chantier

► Réparation automobile

Quantité/Description	Réf. Beta
2 chasse-clous Ø 3 - 4 mm	30
2 chasse-goupilles Ø 6 - 8 mm	31
1 pointeau Ø 4 mm	32
2 burins nervurés 150 - 200 mm	35
20 clés mixtes 1/4+1.1/2"	42AS
6 clés polygonales contre - coudées 1/4x5/16 - 3/8x7/16 - 1/2x9/16 - 5/8x3/4 - 11/16x13/16 - 7/8x15/16"	90AS
11 clés mâles 6 pans coudées O 3/64+3/8"	96AS/B11
10 douilles 12 pans 1/2" O 7/16 - 1/2 - 9/16 - 5/8 - 11/16 - 3/4 - 13/16 - 7/8 - 15/16 - 1"	920AS
1 rallonge - 1/2" 125 mm	920/21
1 rallonge - 1/2" 255 mm	920/22
1 cardan 1/2"	920/25
1 poignée coulissante 1/2"	920/42
1 cliquet réversible à glissières 1/2" Ⓢ	920/50
12 douilles 6 pans 1/4" O □ 3/4", 7/8 - 15/16 - 1 - 1.1/16 - 1.1/8 - 1.1/4 - 1.5/16 1.1/2 - 1.5/8 - 1.11/16 - 1.7/8 - 2"	928AS
1 rallonge - 3/4" 200 mm	928/21
1 poignée articulée 3/4"	928/36A
1 poignée coulissante 3/4"	928/42
1 cliquet réversible 3/4" Ⓢ	928/55
1 pince levier à broche et à bec	964
1 Pince multiprise entrepassée 250 mm	1048N
1 pince-étoupe à becs arrondis	1055
1 pince coupante diagonale à faible effort de coupe, branchées gainées confort bi-matières, finition industrielle 160 mm	1084GBM
1 ciseaux d'électricien	1128BMX
1 pince universelle, branches gainées confort bi-matières, modèle grande capacité, finition industrielle 180 mm	1150GBM
1 pince à becs demi-ronds longs striés, branches gainées confort bi-matières, finition industrielle 160 mm	1166GBM
4 tournevis avec 6 pans pour vis à fente ● 6,5x150 - 8x175 - 10x200 - 12x250 mm	1260E
3 tournevis avec 6 pans pour vis Phillips® ⊕ PH2x150 - PH3x175 - PH4x200 mm	1262E
1 marteau de mécanicien modèle américain 900 g	1377
1 marteau de mécanicien Ø 35 mm	1390
1 jauge d'épaisseur 150 - 200 mm	1708/20
1 grattoir triangulaire 200 mm	1717B
5 limes demi-douces 200 mm	1719BMA...S5
1 monture de scie à métaux	1725



CHF



5902MT/AS

2,890.00 059021054

Composition conseillée avec RSC22 - RSC23 - RSC23C - C39T

5904VG/2M

Composition de 170 outils en plateaux mousse compacte

► Réparation automobile

Quantité/Description

- 16 clés mixtes 6+21 mm
- 5 clés mixtes 22 - 24 - 27 - 30 - 32 mm
- 8 clés mâles 6 pans à poignée en T ○ 2-2,5-3-4-5-6-7-8 mm
- 5 tournevis pour vis Torx® ⊕ T10-T15-T20-T25-T30
- 7 embout avec entraînement hexagonal ○ 4-5-6-7-8-10-12 mm
- 7 embout avec entraînement hexagonal ○ 4-5-6-7-8-10-12 mm
- 5 embout avec entraînement hexagonal ○ 5-6-8-10-12 mm
- 5 embout avec entraînement hexagonal ○ 5-6-8-10-12 mm
- 7 embout avec entraînement hexagonal ⊕ T20-T25-T30-T40-T45-T50-T55
- 6 embout avec entraînement hexagonal ⊕ T25-T30-T40-T45-T50-T55
- 7 Embout avec entraînement hexagonal Tamper Resistant Torx® ⊕ T20-T25-T30-T40-T45-T50-T55
- 1 douille porte-embouts pour 867
- 1 douille porte-embouts pour 867
- 5 tournevis pour vis à fente ● 3x75 - 3,5x100 - 4x125 - 5,5x150 - 6,5x150 mm
- 3 tournevis pour vis Phillips® ⊕ PH0x60 - PH1x80 - PH2x100 mm
- 1 tournevis à lame courte pour vis à fente ● 4x30 mm
- 1 tournevis à lame courte pour vis Phillips® ⊕ PH1x30 mm
- 5 Embout coloré pour visseuses pour vis à fente ● 0,5x3 - 0,6x4,5 - 0,8x5,5 - 1x5,5 - 1,2x6,5 mm
- 8 Embout coloré pour visseuses pour vis 6 pans creux ○ 2 - 2,5 - 3 - 4 - 5 - 6 - 8 - 10 mm
- 5 Embout coloré pour visseuses pour vis Phillips® ⊕ PH0 - PH1 - PH2 - PH3 - PH4
- 4 Embout coloré pour visseuses pour vis Pozidriv® - Supadriv® ⊕ PZ1 - PZ2 - PZ3 - PZ4
- 11 Embout coloré pour visseuses pour vis Torx® ⊕ T6-T7-T8-T9-T10-T15-T20-T25-T27-T30-T40
- 8 Embout coloré pour visseuses pour vis Tamper Resistant Torx® ⊕ T9-T10-T15-T20-T25-T27-T30-T40
- 1 Poignée porte-embouts à bague de déverrouillage rapide 230 mm
- 1 Cliquet réversible porte-embouts 100 mm
- 1 rallonge porte-embouts magnétique 80 mm
- 1 porte-douille pour visseuses ■ 1/4 - □ 1/4
- 2 burins nervurés 100 - 200 mm
- 1 marteau de mécanicien 300 g
- 1 marteau de mécanicien Ø 35 mm
- 1 rallonge angulaire - 1/2" 125 mm
- 1 rallonge angulaire - 1/2" 250 mm
- 1 cardan 1/2"
- 1 poignée coulissante 1/2"
- 1 cliquet réversible 1/2" ⊕
- 19 douilles 6 pans avec carré conducteur femelle 1/2" ○ 10+24 - 26 - 27 - 30 - 32 mm
- 1 pince à becs demi-ronds longs ≡ 180 mm
- 1 Pince à becs demi-ronds longs ● 160 mm
- 1 Pince coupante diagonale à faible effort de coupe † 160 mm
- 1 pinces pour circlips intérieurs à becs droits ○ 180 mm
- 1 pinces pour circlips intérieurs à becs coudés ○ 170 mm
- 1 pinces pour circlips extérieurs à becs droits ● 175 mm
- 1 pinces pour circlips extérieurs à becs coudés ● 175 mm

Réf. Beta	TR
42	M05
42	M06
96T	M50
97TTX	M55
867PE	M86
867PE/L	M86
867XZN	M86
867XZNL	M86
867TX	M86
867TXL	M86
867RTX	M86
867/1	M86
867/2	M86
1260	M208
1262	M208
1260N	M208
1262N	M208
860LP	M85
860PE	M85
860PH	M85
860PZ	M85
860TX	M85
860RTX	M85
851SR	M85
860/55	M85
882P	M85
892/0	M85
35	M234
1370	M234
1390	M234
920AN/125	M83
920AN/250	M83
920/25	M83
920/42	M83
920/55	M83
920A	M83
1150BM	M136
1166BM	M136
1084BM	M136
1032	M145
1034	M145
1036	M145
1038	M145



M05 M06 VPM3



M50 M55 M86



M208 M85 M234



M83 M136 M145

CHF

5904VG/2M

2,195.00 059041198

Composition conseillée avec RSC24 - RSC24A - RSC24AXL - C37 - C39
RSC24L - RSC24L-CAB - C59 - C55 - C39T - C39SM - C39MD - RSC23T - RSC28

5904VG/2T

Composition de 99 outils en plateaux thermoformés rigides en ABS

► Réparation automobile

Quantité/Description

- 16 clés mixtes 6÷21 mm
- 5 clés mixtes 22 - 24 - 27 - 30 - 32 mm
- 19 douilles 6 pans avec carré conducteur femelle 1/2" \odot 10÷24 - 26 - 27 - 30 - 32 mm
- 5 douilles tournevis pour vis 6 pans creux carré femelle 1/2" \odot 5 - 6 - 8 - 10 - 12 mm
- 1 rallonge - 1/2" 125 mm
- 1 rallonge - 1/2" 255 mm
- 1 cardan 1/2"
- 1 poignée coulissante 1/2"
- 1 cliquet réversible 1/2" \otimes
- 1 Pince multiprise entrepassée 250 mm
- 1 pince - étau à becs droits 240 mm
- 1 Pince coupante diagonale à faible effort de coupe \leq 160 mm
- 1 Pince à becs demi-ronds longs \bullet 160 mm
- 1 pince à becs demi-ronds longs \equiv 180 mm
- 1 pinces pour circlips intérieurs à becs droits \odot 180 mm
- 1 pinces pour circlips extérieurs à becs droits \bullet 175 mm
- 1 pinces pour circlips intérieurs à becs coudés \odot 170 mm
- 1 pinces pour circlips extérieurs à becs coudés \bullet 175 mm
- 2 burins nervurés 100 - 200 mm
- 1 marteau de mécanicien 300 g
- 1 marteau de mécanicien \varnothing 35 mm
- 4 tournevis pour vis à fente \bullet 3x75 - 4x100 - 5,5x150 - 6,5x150 mm
- 3 tournevis pour vis Phillips® \oplus PH0x60 - PH1x80 - PH2x100 mm
- 8 clés à fourches 6x7 - 8x9 - 10x11 - 12x13 - 14x15 - 16x17 - 18x19 - 20x22 mm
- 9 clés mâles 6 pans coudées \odot 1,5 - 2 - 2,5 - 3 - 4 - 5 - 6 - 8 - 10 mm
- 6 clés mâles 6 pans à poignée en T \odot 2 - 2,5 - 3 - 4 - 5 - 6 mm
- 6 tournevis pour vis Torx® \otimes T10 - T15 - T20 - T25 - T27 - T30

Réf. Beta	TR
42	T05
42	T06
920A	T80
920ME	T80
920/21	T80
920/22	T80
920/25	T80
920/42	T80
920/55	T80
1048N	T153
1052	T153
1084	T138
1166	T138
1150	T138
1032	T145
1036	T145
1034	T145
1038	T145
35	T234
1370	T234
1390	T234
1260	T208
1262	T208
55	T33
96/SC9	T33
96T	T52
97TTX	T55



T05 T06 T80



T153 T138 T145 T234



T208 T33 T52 T55

CHF

5904VG/2T

1,870.00 059041191

Composition conseillée avec RSC24 - RSC24A - RSC24AXL - C37 - C39
RSC23T - C39T - RSC24L - RSC24L-CAB - C59 - C55 - RSC28 - C39SM - C39MD

5904VG/3

Composition de 132 outils

► Réparation automobile

Quantité/Description	Réf. Beta
6 Ø 2+8 mm	31/B6N
1 pointeau Ø 5 mm	32
1 burins nervurés 200 mm	35
17 clés mixtes 6+22 mm	42
8 clés à fourches 6x7 - 8x9 - 10x11 - 12x13 - 14x15 - 16x17 - 18x19 - 20x22 mm	55
9 clés mâles 6 pans coudées Ø 1,5 - 2 - 2,5 - 3 - 4 - 5 - 6 - 8 - 10 mm	96N/SC9
11 clés mâles 6 pans à poignée en T Ø 2+10 mm	96T/SP11
13 clés mâles coudées pour vis à empreinte Torx® ⚙ T6+T50	97TX/B13
1 Clé à molette à ouverture graduée, chromée 300 mm	111E
13 douilles 6 pans 1/2" sur rail Ø 10+22 mm	920A/SB13
1 rallonge - 1/2" 125 mm	920/21
1 rallonge - 1/2" 255 mm	920/22
1 cardan 1/2"	920/25
1 poignée coulissante 1/2"	920/42
1 cliquet réversible à glissières 1/2" ⚙	920/50
6 clés à béquille à cardan Ø 8 - 10 - 12 - 13 - 17 - 19 mm	952
1 pince levier plate coudée 450 mm	965
2 pinces pour circlips intérieurs à becs droits Ø 180 - 225 mm	1032
2 pinces pour circlips intérieurs à becs coudés Ø 170 - 210 mm	1034
2 pinces pour circlips extérieurs à becs droits Ø 175 - 225 mm	1036
2 pinces pour circlips extérieurs à becs coudés Ø 175 - 220 mm	1038
1 Pince multiprise entrecroisée 250 mm	1048N
1 pince - étau à becs droits 240 mm	1057A
1 pince coupante diagonale à faible effort de coupe, branchées gainées confort bi-matières, finition industrielle 200 mm	1084GBM
1 pince coupante frontale articulée, série lourde 200 mm	1092V
1 cisaille type américain coupe droite 250 mm	1112
1 ciseaux d'électricien	1128BMX
1 pince universelle, branches gainées confort bi-matières, modèle grande capacité, finition industrielle 180 mm	1150GBM
4 tournevis pour vis à fente ⚪ 3x75 - 4x100 - 5,5x125 - 6,5x150 mm	1260
1 tournevis à lame courte pour vis à fente ⚪ 6,5x30 mm	1260N
2 tournevis avec 6 pans pour vis à fente ⚪ 8x175 - 10x200 mm	1260E
3 tournevis pour vis Phillips® ⚪ PH0x100 - PH1x120 - PH2x100 mm	1262
1 tournevis à lame courte pour vis Phillips® ⚪ PH2x30 mm	1262N
1 tournevis avec 6 pans pour vis Phillips® ⚪ PH3x175mm	1262E
1 tournevis à lame longue pour vis Phillips® ⚪ PH2x400 mm	1262L
1 tournevis à lame longue fraisée pour vis à fente ⚪ 6,5x400 mm	1264L
1 marteau de mécanicien 500 g	1370
1 marteau de mécanicien Ø 45 mm	1390
1 massette à embouts plastiques	1491
1 jauge d'épaisseur	1708/20
5 limes demi-douces 200 mm	1719BMA...S5
1 monture de scie à métaux	1726BM
1 Burette tôle 200 cc	1751N



CHF



5904VG/3

2,930.00 059041062

Composition conseillée avec RSC24 - RSC24A - RSC24AXL - C37 - C39 à 7 - 8 tiroirs RSC24L - RSC24L-CAB - C59 - C55

5904VG/3T

Composition de 102 outils en plateaux thermoformés rigides en ABS

► Réparation automobile

Quantité/Description

- 21 clés mixtes 6-7-8-9-10-11-12-13-14-15-16-17
18-19-20-21-22-24-27-30-32 mm
- 8 clés à fourches 6x7-8x9-10x11-12x13-14x15
16x17-18x19-20x22 mm
- 9 clés mâles 6 pans coudées \odot 1,5+10 mm
- 6 clés mâles 6 pans à poignée en T \odot 2-2,5-3-4-5-6 mm
- 8 clés à béquille à cardan \odot 7-8-10-12-13-14-17-19 mm
- 19 douilles 6 pans avec carré conducteur femelle 1/2" \odot 10-11-12-13-14-15-16-17-18-19
20-21-22-23-24-26-27-30-32 mm
- 1 rallonge - 1/2" 125 mm
- 1 rallonge - 1/2" 255 mm
- 1 cardan 1/2"
- 1 poignée coulissante 1/2" 305 mm
- 1 cliquet réversible 1/2" \otimes
- 1 Pince coupante diagonale à faible effort de coupe \leq 160 mm
- 1 pince à becs demi-ronds longs \equiv 180 mm
- 1 Pince à becs demi-ronds longs \bullet 160 mm
- 1 pinces pour circlips intérieurs à becs droits \odot 180 mm
- 1 pinces pour circlips intérieurs à becs coudés \odot 170 mm
- 1 pinces pour circlips extérieurs à becs droits \bullet 175 mm
- 1 pinces pour circlips extérieurs à becs coudés \bullet 175 mm
- 1 pince - étau à becs droits 240 mm
- 1 Pince multiprise entrepassée 250 mm
- 7 tournevis pour vis à fente \bullet 2,5x50 - 3x75 - 3,5x100 - 4x125 - 5,5x100 - 5,5x150 - 6,5x150 mm
- 6 tournevis pour vis Phillips® \oplus PH0x60 - PH0x100 - PH1x80
PH1x120 - PH2x100 - PH2x150 mm
- 2 burins nervurés 100-200 mm
- 1 marteau de mécanicien 300 g
- 1 marteau de mécanicien \varnothing 35 mm
- 1 bac de rangement

Réf. Beta	TR
42T05-T06	
55	T33
96/SC9	T33
96T	T52
952	T63
920A	T83
920/21	T83
920/22	T83
920/25	T83
920/42	T83
920/55	T83
1084BM	T137
1150BM	T137
1166BM	T137
1032	T145
1034	T145
1036	T145
1038	T145
1052	T153
1048N	T153
1260	T199
1262	T202
35	T234
1370	T234
1390	T234
VP5	



T199 T202 T83



T145 T153 T137 T234



T52 T33 T05 T06



T63 VP5

5904VG/3T

CHF



2,165.00 059041510

Composition conseillée avec C24S - C24SA - C37 - C39
C24SL - C24SL/CAB - C59 - C55 - C23ST - C39T - C28 - C39SM - C39MD

5904VG/5T

Composition de 153 outils en plateaux thermoformés rigides en ABS

► Réparation automobile

Quantité/Description

- 5 douilles tournevis pour vis 6 pans creux carré femelle 1/2" ○ 5 - 6 - 8 - 10 - 12 mm
- 1 rallonge - 1/2" 125 mm
- 1 rallonge - 1/2" 255 mm
- 1 cardan 1/2"
- 1 poignée coulissante 1/2"
- 1 cliquet réversible 1/2" Ⓢ
- 19 douilles 6 pans avec carré conducteur femelle 1/2" ○ 10+24 - 26 - 27 - 30 - 32 mm
- 16 clés mixtes 6+21 mm
- 5 clés mixtes 22 - 24 - 27 - 30 - 32 mm
- 8 clés à béquille à cardan ○ 7 - 8 - 10 - 12 - 13 - 14 - 17 - 19 mm
- 1 bac de rangement
- 1 pinces pour circlips intérieurs à becs droits ○ 180 mm
- 1 pinces pour circlips intérieurs à becs coudés ○ 170 mm
- 1 pinces pour circlips extérieurs à becs droits ● 175 mm
- 1 pinces pour circlips extérieurs à becs coudés ● 175 mm
- 7 tournevis pour vis Phillips® ● 2,5x50 - 3x75 - 3,5x100
4x125 - 5,5x100 - 5,5x150 - 6,5x150 mm
- 5 tournevis pour vis Torx® ○ T25 - T27 - T30 - T40 - T45
- 6 clés mâles 6 pans à poignée en T ○ 2 - 2,5 - 3 - 4 - 5 - 6 mm
- 8 clés à fourches 6x7 - 8x9 - 10x11 - 12x13 - 14x15 - 16x17
18x19 - 20x22 mm
- 9 clés mâles 6 pans coudées ○ 1,5 - 2 - 2,5 - 3 - 4 - 5 - 6 - 8 - 10 mm
- 3 tournevis pour vis Phillips® ● 8x150 - 8x200 - 10x200 mm
- 2 tournevis à lame courte pour vis à fente ● 4x30 - 6,5x30 mm
- 6 tournevis pour vis Phillips® ⚡ PH0x60 - PH0x100 - PH1x80
PH1x120 - PH2x100 - PH2x150 mm
- 2 tournevis pour vis Phillips® ⚡ PH3x150 - PH4x200 mm
- 2 tournevis à lame courte pour vis Phillips® ⚡ PH1x30 - PH2x30 mm
- 2 burins nervurés 100 - 200 mm
- 1 marteau de mécanicien 300 g
- 1 marteau de mécanicien Ø 35 mm
- 1 pince à becs demi-ronds longs ≡ 180 mm
- 1 Pince à becs demi-ronds longs ● 160 mm
- 1 Pince coupante diagonale à faible effort de coupe ✂ 160 mm
- 6 embouts de visseuse pour vis à empreinte Torx® ○ T6+T15
- 8 embouts de visseuse pour vis à empreinte Torx® ○ T20+T55
- 1 douille porte-embouts
- 1 douille porte-embouts
- 6 douilles pour écrous à empreinte Torx®, 1/4" ○ E4+E10
- 7 douilles pour écrous à empreinte Torx®, 1/2" ○ E12+E24
- 3 douilles tournevis pour vis à empreinte Torx® ○ T55L - T60 - T70L
- 1 Pince multiprise entrepassée 250 mm
- 1 pince - étau à becs droits 240 mm

Réf. Beta	TR
920ME	T80
920/21	T80
920/22	T80
920/25	T80
920/42	T80
920/55	T80
920A	T80
42	T05
42	T06
952	T63
VP6	VP6
1032	T145
1034	T145
1036	T145
1038	T145
1290	T170
1297TX	T176
96T	T52
55	T33
96N/SC9	T33
1290	T171
1290N	T171
1292	T172
1292	T173
1292N	T173
35	T234
1370	T234
1390	T234
1150BM	T137
1166BM	T137
1084BM	T137
861TX	T112
866TX	T112
895/1	T112
895/6	T112
900FTX	T112
920FTX	T112
920TX	T112
1048N	T153
1052	T153



T80 T05 T06



T63 VP6



T145 T170 T176 T52



T33 T171 T172 T173



T234 T137 T112 T153

CHF

5904VG/5T 2,990.00 059041196

Composition conseillée avec RSC24 à 7 - 8 tiroirs - RSC24A à 7 - 8 tiroirs - RSC24AXL - C37 à 7 - 8 tiroirs - C39 à 7 - 8 tiroirs RSC24L - RSC24L-CAB - C59 - C55 - RSC23T - RSC28 - C39MD - C39SM

5905VG/1

Composition de 94 outils pour carrossier

► Réparation automobile

Quantité/Description	Réf. Beta
1 chasse-clous Ø 4 mm	30
6 Ø 2 - 3 - 4 - 5 - 6 - 8 mm	31/B6N
1 pointeau Ø 4 mm	32
1 burins plats 150 mm	34
1 bédanes 150 mm	36
17 clés mixtes 6+22 mm	42
10 clés mâles 6 pans coudées O 1,5+12 mm	96/B10
1 Clé à molette à ouverture graduée, phosphatée 300 mm	111EN
12 Clé à douille emmanchée, série longue O 4+14 mm	943BX
1 pince levier plate coudée 450 mm	965
1 Pince multiprise entrepassée 250 mm	1048N
1 pince - étau à becs droits 240 mm	1052
1 pince-étau pour cornière 280 mm	1060AL
1 pince coupante diagonale à faible effort de coupe, branchées gainées confort bi-matières, finition industrielle ∇ 160 mm	1084GBM
1 tenaille type russe 250 mm	1098PL
1 cisaille bichantourneuse coupe droite	1122
1 ciseaux d'électricien	1128BMX
1 pince universelle, branches gainées confort bi-matières, modèle grande capacité, finition industrielle \equiv 180 mm	1150GBM
1 tournevis pour vis Dzus® \bullet	1201E/DZ
4 tournevis pour vis à fente \bullet 3x75 - 4x100 - 5,5x150 - 6,5x150 mm	1260
1 tournevis à lame courte pour vis à fente \bullet 4x30 mm	1260N
2 tournevis avec 6 pans pour vis à fente \bullet 10x175 - 12x200 mm	1260E
3 tournevis pour vis Phillips® \oplus PH0x60 - PH1x80 - PH2x100 mm	1262
1 tournevis à lame courte pour vis Phillips® \oplus PH1x30 mm	1262N
1 tournevis avec 6 pans pour vis Phillips® \oplus PH3x175 mm	1262E
7 tournevis pour vis Torx® \otimes T6 - T8 - T10 - T15 - T20 - T25 - T30	1267TX
1 tas virgule 1350 g	1303
1 tas courbure	1305
1 tas talon	1306
1 tas universel	1310
1 tas à tête ronde convexe	1314
1 palette simple étroite bombée	1326
1 palette simple longue bombée	1327
1 palette double col de cygne	1330
1 monture plate et flexible 9"	1338A
1 burin plat de carrossier	1342PM
1 marteau à planer tête ronde bombée	1345
1 marteau à rétreindre Ø 40 mm	1357Z/45
1 marteau de mécanicien 300 g	1370
1 marteau de mécanicien Ø 35 mm	1390
1 mètre à ruban 5 m	1692



CHF



5905VG/1 2,650.00 059051058

Composition conseillée avec C25

5905VG/2

Composition de 118 outils

► Réparation automobile

Quantité/Description	Réf. Beta
6 2 poinçons de dérive, 1 poinçon central, 2 ciseaux plats et 1 ciseau à cape en portefeuille enroulable en polyester	38/B6N
13 clés mixtes 6+14 - 17 - 19 - 22 - 24 mm	42
13 clés à fourches 6x7 - 8x9 - 10x11 - 12x13 - 14x15 - 16x17 - 18x19 - 20x22 - 21x23 - 24x26 - 25x28 - 27x29 - 30x32 mm	55
3 clés polygonales demi - lune 11x13 - 14x17 - 19x22 mm	83
10 clés mâles 6 pans coudées Ø 1,5+12 mm	96N/B10
6 tournevis pour vis Torx® T10 - T15 - T20 - T25 - T30 - T40	97TTX
2 douilles à choc carré conducteur femelle 1/2" Ø 17 - 19 mm	720
20 douilles 6 pans avec carré conducteur femelle 1/2" Ø 10+24 - 26 - 27 - 28 - 30 - 32 mm	920A
1 rallonge - 1/2" 125 mm	920/21
1 rallonge - 1/2" 255 mm	920/22
1 cardan 1/2"	920/25
1 poignée coulissante 1/2"	920/42
1 cliquet réversible 1/2" Ⓢ	920/55
8 clés à béquille à cardan Ø 7 - 8 - 10 - 11 - 13 - 14 - 17 - 19 mm	952
1 clés à bougies à cardan	959
1 clé en croix pour écrous de roues Ø 17x19x22x 1/2"	979
1 pinces pour circlips intérieurs à becs droits Ø 180 mm	1032
1 pinces pour circlips intérieurs à becs coudés Ø 170 mm	1034
1 pinces pour circlips extérieurs à becs droits Ø 175 mm	1036
1 pinces pour circlips extérieurs à becs coudés Ø 175 mm	1038
1 Pince multiprise entrepassée 250 mm	1048N
1 pince - étai à becs droits 240 mm	1052
1 pince coupante diagonale à faible effort de coupe, branchées gainées confort bi-matières, finition industrielle 160 mm	1084GBM
1 cisaille bichantourneuse coupe droite 250 mm	1122
1 ciseaux d'électricien	1128BMX
1 pince universelle, branches gainées confort bi-matières, modèle grande capacité, finition industrielle 180 mm	1150GBM
1 pince à becs demi-ronds longs striés, branches gainées confort bi-matières, finition industrielle Ø 160 mm	1166GBM
8 tournevis pour vis à fente Ø 2,5x50 - 3x75 - 3,5x100 - 4x125 - 5,5x125 - 6,5x150 - 8x200 - 10x200 mm	1260
2 tournevis avec 6 pans pour vis à fente Ø 10x200 - 12x250 mm	1260E
1 tournevis à lame courte pour vis à fente Ø 6,5x30 mm	1260N
4 tournevis pour vis Phillips® PH0x60 - PH1x80 - PH2x100 - PH3x150 mm	1262
1 marteau de mécanicien 400 g	1370
1 marteau de mécanicien Ø 35 mm	1390
1 massette à embouts plastiques	1491
1 clé à sangle pour filtre à huile 3+48 V	1498



CHF



5905VG/2

2,490.00 059051044

Composition conseillée avec C25

5908VG/2T

Composition de 212 outils en plateaux thermoformés rigides en ABS

► Réparation automobile

Quantité/Description

Quantité/Description	Réf. Beta	TR
16 clés mixtes 6÷21 mm	42	T05
5 clés mixtes 22 - 24 - 27 - 30 - 32 mm	42	T06
5 chasse-goupilles Ø 2 - 3 - 4 - 5 - 6 mm	31	T31
1 pointeau Ø 4 mm	32	T31
12 clés à fourches 6x7 - 8x9 - 10x11 - 12x13 - 14x15 - 16x17 18x19 - 20x22 - 21x23 - 24x26 - 27x29 - 30x32 mm	55	T31
9 clés mâles 6 pans coudées ○ 1,5 - 2 - 2,5 - 3 - 4 - 5 - 6 - 8 - 10 mm	96N/SC9	T31
5 douilles tournevis pour vis 6 pans creux carré femelle 1/2" ○ 5 - 6 - 8 - 10 - 12 mm	920ME	T80
1 rallonge - 1/2" 125 mm	920/21	T80
1 rallonge - 1/2" 255 mm	920/22	T80
1 cardan 1/2"	920/25	T80
1 poignée coulissante 1/2"	920/42	T80
1 cliquet réversible 1/2" ⊕	920/55	T80
19 douilles 6 pans avec carré conducteur femelle 1/2" ○ 10÷24 - 26 - 27 - 30 - 32 mm	920A	T80
1 pinces pour circlips intérieurs à becs droits ○ 180 mm	1032	T145
1 pinces pour circlips intérieurs à becs coudés ○ 170 mm	1034	T145
1 pinces pour circlips extérieurs à becs droits ● 175 mm	1036	T145
1 pinces pour circlips extérieurs à becs coudés ● 175 mm	1038	T145
1 pinces pour circlips intérieurs à becs droits ○ 140 mm	1032	T146
1 pinces pour circlips intérieurs à becs droits ○ 225 mm	1032	T146
1 pinces pour circlips extérieurs à becs droits ● 140 mm	1036	T146
1 pinces pour circlips extérieurs à becs droits ● 225 mm	1036	T146
9 tournevis pour vis à fente ● 3x75 - 3x100 - 4x100 - 4x150 - 5,5x100 - 5,5x150 - 6,5x150 - 8x150 - 10x200 mm	1260	T167
2 tournevis à lame courte pour vis à fente ● 4x30 - 6,5x30 mm	1260N	T167
7 tournevis pour vis Phillips® ⊕ PH0x60 - PH0x100 - PH1x80 - PH1x120 - PH2x100 - PH2x150 - PH3x150 mm	1262	T168
2 tournevis à lame courte pour vis Phillips® ⊕ PH1x30 - PH2x30 mm	1262N	T168
8 clés à béquille à cardan ○ 7 - 8 - 10 - 12 - 13 - 14 - 17 - 19 mm	952	T63
2 tournevis à lame longue pour vis Phillips® ⊕ PH1x400 - PH2x400 mm	1262L	T209
3 tournevis à lame longue fraisée pour vis à fente ● 3x300 - 4x400 - 5x400 mm	1264L	T209
6 tournevis pour vis Torx® ⊖ T10-T15-T20-T25-T27-T30	97TTX	T55
12 douilles à choc carré conducteur femelle 1/2" ○ 10-13-17-18-19-21-22-24-27-30-32 mm	720	T111
1 Rallonge carrés mâle et femelle 1/2" 125 mm	720/21	T111
3 ○ 17-19-21	720LC	T111
5 Douille tournevis pour vis 6 pans creux ○ 5L - 6L - 7L - 8L - 10L	920PE	T113
4 douilles tournevis pour vis à empreinte Torx® ⊖ T40L - T45L - T55L - T70L	920TX	T113
3 Douille tournevis pour vis XZN® ○ M6L - M8L - M12L	920XZN	T113
5 limes demi-douces 200 mm	1719BMA8/S5	T236
1 massette à embouts plastiques 110 mm	1491	T264
1 Douille carrée pour bouchons de vidange moteur ■ 10 mm	1494	T264
7 Douille mâle 6 pans pour bouchons de vidange moteur ○ 8-9-10-11-12-14-17 mm	1494E	T264
4 Douille mâle carrée pour bouchons de vidange moteur ○ 8-9,5-12-13 mm	1494Q	T264
1 Douille mâle triangulaire pour bouchons de vidange moteur Δ	1494T	T264
1 Douille mâle bouchons pour vidange moteur XZN® ○	1494XZN	T264
1 Clé de vidange	1496C	T264
2 burins nervurés 100 - 200 mm	35	T234
1 marteau de mécanicien 300 g	1370	T234
1 marteau de mécanicien Ø 35 mm	1390	T234
1 Pince multiprise entrecroisée 250 mm	1048N	T153
1 pince - étai à becs droits 240 mm	1052	T153
1 pince à becs demi-ronds longs ≡ 180 mm	1150	T138
1 Pince à becs demi-ronds longs ● 160 mm	1166	T138
1 Pince coupante diagonale à faible effort de coupe ≡ 160 mm	1084	T138
11 douilles 6 pans 3/4" ○ 22-24-27-30-32-34-36-38-41-46-50 mm	928A	T105
1 rallonge - 3/4" 200 mm	928/21	T106
1 rallonge - 3/4" 380 mm	928/22	T106
1 poignée coulissante 3/4" 450 mm	928/42	T106
1 cliquet réversible 3/4" ⊕	928/55	T106
1 bac de rangement	VP6	VP6
4 clés mâles 6 pans coudées ○ 13-14-17-19 mm	96N	
1 Clé à molette à ouverture graduée, chromée 300 mm	111E	
1 pince levier plate coudée	965	
1 cisaille type américain coupe droite 250 mm	1112	
1 ciseaux d'électricien	1128BMX	
1 marteau de mécanicien 1000 g	1370	
1 jauge d'épaisseur	1708/20	
1 doigt magnétique flexible	1712	
1 miroir d'inspection télescopique	1715	
1 grattoir triangulaire 200 mm	1717B	
1 monture de scie à métaux 440 mm	1726	
1 Brosse à bougies en fils de acier	1737NX	
1 Burette tôle 200 cl	1751N	
1 cutter à lame sécable 18 mm avec lames	1771	



5908VG/2T

CHF 5,070.00 059081017

Composition conseillée avec RSC28

5910VG/3T

Composition de 202 outils en plateaux thermoformés rigides en ABS

► Réparation automobile

Quantité/Description

- 16 clés mixtes 6+21 mm
- 5 clés mixtes 22 - 24 - 27 - 30 - 32 mm
- 6 Clé à douilles articulées 8x9 - 10x11 - 12x13 - 14x15 - 16x17 - 18x19 mm
- 1 massette à embouts plastiques 110 mm
- 1 Douille carrée pour bouchons de vidange moteur ■ 10 mm
- 7 Douille mâle 6 pans pour bouchons de vidange moteur ○ 8-9-10-11-12-14-17 mm
- 4 Douille mâle carrée pour bouchons de vidange moteur ○ 8-9,5-12-13 mm
- 1 Douille mâle triangulaire pour bouchons de vidange moteur Δ
- 1 Douille mâle bouchons pour vidange moteur XZN ○
- 1 Clé de vidange
- 5 douilles tournevis pour vis 6 pans creux carré femelle 1/2" ○ 5 - 6 - 8 - 10 - 12 mm
- 1 rallonge - 1/2" 125 mm
- 1 rallonge - 1/2" 255 mm
- 1 cardan 1/2"
- 1 poignée coulissante 1/2"
- 1 cliquet réversible 1/2" Ⓢ
- 19 douilles 6 pans avec carré conducteur femelle 1/2" ○ 10+24 - 26 - 27 - 30 - 32 mm
- 1 pinces pour circlips intérieurs à becs droits ○ 180 mm
- 1 pinces pour circlips intérieurs à becs coudés ○ 170 mm
- 1 pinces pour circlips extérieurs à becs droits ● 175 mm
- 1 pinces pour circlips extérieurs à becs coudés ● 175 mm
- 1 pinces pour circlips intérieurs à becs droits ○ 140 mm
- 1 pinces pour circlips intérieurs à becs coudés ○ 225 mm
- 1 pinces pour circlips extérieurs à becs droits ● 140 mm
- 1 pinces pour circlips extérieurs à becs coudés ● 225 mm
- 6 tournevis pour vis Torx® ○ T10-T15-T20-T25-T27-T30
- 12 Clé mixte à cliquet articulé 8 - 9 - 10 - 11 - 12 - 13 - 14 - 15 - 16 - 17 - 18 - 19 mm
- 1 pince à becs demi-ronds longs = 180 mm
- 1 Pince à becs demi-ronds longs ● 160 mm
- 1 Pince coupante diagonale à faible effort de coupe ✂ 160 mm
- 1 Pince multiprise entrecroisée avec bouton de réglage 240 mm
- 1 pince - étau à becs droits 240 mm
- 8 clés à béquille à cardan ○ 7 - 8 - 10 - 12 - 13 - 14 - 17 - 19 mm
- 9 tournevis pour vis à fente ● 3x75 - 3,5x100 - 4x100 - 4x150 - 5,5x100 - 5,5x150 - 6,5x150 - 8x150 - 10x200 mm
- 2 tournevis à lame courte pour vis à fente ● 4x30 - 6,5x30 mm
- 6 poinçons à 6 broches
- 7 tournevis pour vis Phillips® ⚙ PH0x60 - PH0x100 - PH1x80 - PH1x120 - PH2x100 - PH2x150 - PH3x150 mm
- 2 tournevis à lame courte pour vis Phillips® ⚙ PH1x30 - PH2x30 mm
- 1 Clé à molette à ouverture graduée, chromée 250 mm
- 1 poignée à béquille à cardan 1/2"
- 6 clés mâles 6 pans en T ○ 2,5-3-4-5-6-8 mm
- 4 clés mâles 6 pans à béquille à cardan ○ 4-5-6-8 mm
- 2 marteau de mécanicien 300-500 g
- 2 tournevis à lame longue pour vis Phillips® ⚙ PH1x400 - PH2x400 mm
- 3 tournevis à lame longue fraisée pour vis à fente ● 3x300 - 4x400 - 5x400 mm
- 9 clés mâles 6 pans coudées à tête sphérique ○
- 1 clé dynamométrique à déclenchement avec cliquet réversible Ⓢ 8 + 60 Nm
- 1 clé dynamométrique à déclenchement avec cliquet réversible Ⓢ 60 + 330 Nm
- 12 Douille à chocs
- 1 Réducteur carré mâle 1/2" et femelle 3/8"
- 1 composition de 12 douilles et 5 accessoires 3/4"
- 3 Levier avec une tête articulée plate courbe
- 1 massette sans rebond Ø 50 mm
- 1 Clé à chocs réversible en matériau composite Ⓢ

Réf. Beta	TR
42	T05
42	T06
80	T79
1491	T264
1494	T264
1494E	T264
1494Q	T264
1494T	T264
1494XZN	T264
1496C	T264
920ME	T80
920/21	T80
920/22	T80
920/25	T80
920/42	T80
920/55	T80
920A	T80
1032	T145
1034	T145
1036	T145
1038	T145
1032	T146
1034	T146
1036	T146
1038	T146
97TTX	T55
142SN	T46
1150BM	T137
1166BM	T137
1084BM	T137
1047	T151
1057A	T151
952	T63
1260	T167
1260N	T167
31/B6N	T168
1262	T168
1262N	T168
111E	T59
920/40	T59
951	T59
953	T59
1370	T59
1262L	T209
1264L	T209
96BPC/SC9	T209
666N/5	T209
666N/30	T209
720C/12	T209
910/16	T209
928A/C12	T209
966C/3	T209
1392	T209
1927P	T209



T05 T06 T79 T264

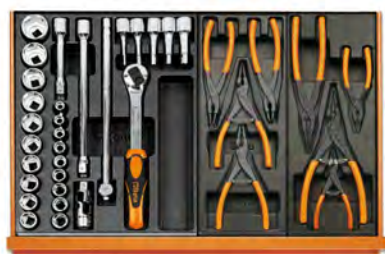

T80 T145 T146



T55 T46 T137 T151

T63



T167 T168 + 96BPC/SC9 + 31/B6N

T59



T209



CHF

5910VG/3T

7,090.00 059101068

Composition conseillé en association avec C30M



MB12



MB39



MB46

5935VG/1MB

Composition de 98 outils pour coffre C35, en plateaux mousse compacte

► Réparation automobile

Quantité/Description

- 21 clés mixtes 6-7-8-9-10-11-12-13-14-15-16-17-18-19-20-21-22-24-27-30-32 mm
- 8 clés à fourches 6x7-8x9-10x11-12x13-14x15
16x17-18x19-20x22 mm
- 1 Pince multiprise entrepassée 250 mm
- 4 tournevis pour vis à fente ● 3x75-4x100-5x125-6,5x150 mm
- 3 tournevis pour vis Phillips® ● PH0x60-PH1x80-PH2x100 mm
- 6 tournevis pour vis Torx® ○ T8-T10-T15-T20-T25-T30
- 9 clés mâles 6 pans coudées à tête sphérique ○
- 6 clés mâles 6 pans à poignée en T ○ 2-2,5-3-4-5-6
- 1 pince - étau à becs droits 240 mm
- 19 douilles 6 pans avec carré conducteur femelle 1/2" ○ 10-11-12-13-14-15-16-17-18-19-20-21-
22-23-24-26-27-30-32 mm
- 1 rallonge - 1/2" 125 mm
- 1 rallonge - 1/2" 250 mm
- 1 cardan 1/2"
- 1 poignée coulissante 1/2"
- 1 cliquet réversible 1/2" ⊗
- 5 Douille tournevis pour vis 6 pans creux ○ 5-6-8-10-12 mm
- 1 pinces pour circlips intérieurs à becs droits ○ 180 mm
- 1 pinces pour circlips intérieurs à becs coudés ○ 170 mm
- 1 pinces pour circlips extérieurs à becs droits ● 175 mm
- 1 pinces pour circlips extérieurs à becs coudés ● 175 mm
- 1 burins nervurés 200 mm
- 1 Pince coupante diagonale à faible effort de coupe ≦ 160 mm
- 1 pince à becs demi-ronds longs ≡ 180 mm
- 1 Pince à becs demi-ronds longs ● 160 mm
- 1 marteau de mécanicien 500 g
- 1 marteau de mécanicien 35 mm

Réf. Beta	TR
42	MB12
55	MB12
1048N	MB12
1260	MB46
1262	MB46
1267TX	MB46
96BPC/SC9	MB46
96T	MB46
1052	MB46
920A	MB39
920/21	MB39
920/22	MB39
920/25	MB39
920/42	MB39
920/55	MB39
920PE	MB39
1032	MB39
1034	MB39
1036	MB39
1038	MB39
35	MB39
1084BM	MB39
1150BM	MB39
1166BM	MB39
1370	MB39
1390	MB39

CHF

5935VG/1MB

2,110.00 059351321

Composition conseillée avec C35

5940SBK

Composition de 125 outils

► Réparation motocycles

Quantité/Description

- 1 chasse-clous Ø 2 mm
- 1 pointeau Ø 4 mm
- 1 burins plats 125 mm
- 10 clés mixtes 6 - 7 - 8 - 10 - 11 - 12 - 13 - 14 - 17 - 19 mm
- 6 clés à fourches 6x7 - 8x9 - 10x11 - 12x13 - 14x15 - 16x17 mm
- 9 clés mâles 6 pans coudées ○ 1,5 - 2 - 2,5 - 3 - 4 - 5 - 6 - 8 - 10 mm
- 1 clé dynamométrique à déclenchement avec cliquet réversible ⊗ 3/8", 8÷60 Nm
- 54 jeu de 52 embouts avec entraînement hexagonal de 10 mm et 2 accessoires
- 17 jeu de 12 douilles et 5 accessoires
- 1 Réducteur carré mâle 1/2" et femelle 3/8"
- 2 douille à bougies ○ 14 - 16 mm
- 1 pince extra - longue à becs demi - ronds ● 283 mm
- 2 pinces pour circlips intérieurs à becs droits ○ 140 - 180 mm
- 1 pinces pour circlips extérieurs à becs droits ● 140x1,3 mm
- 1 pince coupante diagonale, branches gainées avec double couche de PVC antidérapant, finition industrielle ≦ 160 mm
- 1 ciseaux d'électricien
- 1 pince universelle, branches gainées avec double couche de PVC antidérapant, modèle grande capacité, finition industrielle ≡ 180 mm
- 1 tournevis pour vis Dzus® ●
- 4 tournevis pour vis à fente ● 3x75 - 4x100 - 5,5x100 - 6,5x150 mm
- 3 tournevis pour vis Phillips® ● PH0x60 - PH1x80 - PH2x100 mm
- 1 Tournevis détecteur de tension à pince crocodile ●
- 1 marteau de mécanicien 300 g
- 1 massette à embouts plastiques
- 1 jauge d'épaisseur
- 1 mini - monture de scie à métaux
- 1 Brosse à bougies en fils de cuivre
- 1 burette plastique 250 cc

Réf. Beta	TR
30	
32	
34	
42	
55	
96/SC9	
666N/5	
867/C52	
920A/C12X	
910/16	
956C	
1009L/A	
1032	
1036	
1082G	
1128BM	
1150G	
1201E/DZ	
1201E	
1202E	
1254	
1370	
1491	
1708/13	
1725CR	
1737	
1754	

CHF

5940SBK

1,595.00 059401082

Composition conseillé en association avec C41S - C41H - C42S - C42H - C42S - C41S

5941VU/M

Composition de 64 outils pour chariot C41H, en plateau mousse compacte

► Maintenance générale

Quantité/Description

- 16 clés mixtes 6-7-8-9-10-11-12-13-14-15-16-17-18-19-21-22 mm
- 9 clés mâles 6 pans coudées ○
- 1 mètre à ruban 5 m
- 19 douilles 6 pans avec carré conducteur femelle 1/2" ○ 10-11-12-13-14-15-16-17-18-19-20-21-22-23-24-26-27-30-32 mm
- 1 cardan 1/2"
- 1 poignée coulissante 1/2"
- 1 cliquet réversible 1/2" ⊕
- 2 rallonge angulaire - 1/2" 125-250 mm
- 1 Clé à molette à ouverture graduée, chromée 250 mm
- 1 Pince multiprise entrepassée 250 mm
- 1 Pince coupante diagonale ✂ 160 mm
- 1 ciseaux d'électricien 145 mm
- 1 pince universelle, branches gainées confort bi-matières, modèle grande capacité, finition industrielle = 180 mm
- 1 pince à becs demi-ronds longs striés, branches gainées confort bi-matières, finition industrielle ● 160 mm
- 3 tournevis pour vis à fente ● 3,5x100-5,5x125-6,5x150 mm
- 3 tournevis pour vis Phillips® ⊕ PH0-PH1-PH2
- 1 marteau de mécanicien 300 g
- 1 cutter à lame sécable 18 mm avec lames 18 mm

Réf. Beta	TR
42	MC12
96/SC9	MC12
1692/5	MC12
920A	MC21
920/25	MC21
920/42	MC21
920/55	MC21
920AN	MC21
111E	
1048N	
1082GBM	
1128BMX	
1150GBM	
1166GBM	
1260	
1262	
1370	
1771	



MC21



MC12



CHF



5941VU/M

1,070.00 059411002

Composition conseillé en association avec C41

Beta

5945VUM

Composition de 231 outils en plateaux mousse compacte

► Maintenance générale

Quantité/Description

- 21 clés mixtes 6-7-8-9-10-11-12-13-14-15-16-17-18-19-20-21-22-24-27-30-32 mm
 9 clés mâles 6 pans coudées à tête sphérique \odot 1,5-2-2,5-3-4-5-6-8-10 mm
 8 clés mâles 6 pans à poignée en T \odot 2-2,5-3-4-5-6-7-8 mm
 1 marteau de mécanicien 300 g
 1 marteau de mécanicien \varnothing 35
 2 burins nervurés 100-200 mm
 5 limes demi-douces 200 mm
 1 douille porte-embouts \square 1/4 - \square 1/4
 1 douille porte-embouts \square 1/4 - \square 3/8
 1 douille porte-embouts \square 5/16 - \square 1/2
 13 douilles 6 pans avec carré conducteur femelle 1/4" \odot 4-4,5-5-5,5-6-7-8-9-10-11-12-13-14 mm
 9 douille 6 pans série longue \odot 5-6-7-8-9-10-11-12-13 mm
 5 douilles tournevis pour vis 6 pans creux carré femelle 1/4" \odot 3-4-5-6-7 mm
 4 douille tournevis pour vis à fente \bullet 0,8x4-1x5,5x1,2x6,5-1,2x8 mm
 4 douille tournevis pour vis Phillips® \oplus PH1-PH2-PH3-PH4
 7 douille tournevis pour vis Torx® \odot T10-T15-T20-T25-T27-T30-T40
 1 augmentateur carré femelle 1/4" et mâle 3/8" \square 1/4 - \blacksquare 3/8
 1 rallonge - 1/4" 50 mm
 1 rallonge - 1/4" 100 mm
 1 rallonge - 1/4" 150 mm
 1 cardan avec carrés mâle et femelle 1/4"
 1 poignée emmanchée avec carré mâle 1/4" 176 mm
 1 poignée coulissante avec carré mâle 1/4" 115 mm
 1 cliquet réversible avec carré mâle 1/4" \oplus 125 mm
 17 douilles 6 pans 3/8" \odot 6-7-8-9-10-11-12-13-14-15-16-17-18-19-20-21-22 mm
 1 Réducteur carré femelle 3/8" et mâle 1/4" \square 3/8 - \blacksquare 1/4
 1 Réducteur carré mâle 1/2" et femelle 3/8" \square 3/8 - \blacksquare 1/2
 1 rallonge - 3/8" 125 mm
 1 rallonge - 3/8" 250
 1 cardan 3/8"
 1 poignée coulissante 3/8" 210 mm
 1 cliquet réversible avec carré mâle 3/8" \oplus 200 mm
 21 douilles 6 pans avec carré conducteur femelle 1/2" \odot 8-10-11-12-13-14-15-16-17-18-19-20-21-22-23-24-26-27-28-30-32 mm
 1 réducteur carré femelle 1/2" et mâle 3/8" \square 1/2 - \blacksquare 3/8
 1 cardan 1/2"
 1 rallonge angulaire - 1/2" 125 mm
 1 rallonge angulaire - 1/2" 250 mm
 1 poignée coulissante 1/2" 305 mm
 1 cliquet réversible 1/2" \oplus 275 mm
 3 douilles pour bougies 3/8" \odot 16 mm (5/8")-17,8 (11/16")-20,8 (13/16")
 5 tournevis pour vis Torx® \odot T10-T15-T20-T25-T30
 1 Pince coupante diagonale à faible effort de coupe ζ 160 mm
 1 pince à becs demi-ronds longs \equiv 180 mm
 1 Pince à becs demi-ronds longs \bullet 160 mm
 1 pinces pour circlips intérieurs à becs droits \odot 19+60 mm
 1 pinces pour circlips intérieurs à becs coudés \odot 19+60 mm
 1 pinces pour circlips extérieurs à becs droits \bullet 19+60 mm
 1 pinces pour circlips extérieurs à becs coudés \bullet 19+60 mm
 1 Pince multiprise entrepassée 250 mm
 1 pince - étau à becs droits 240 mm
 38 micro-tournevis avec 36 embouts interchangeables de 4 mm et rallonge magnétique, poignée bi-matière
 6 tournevis pour vis à fente \bullet 04x2,5x50-0,5x3x75-0,8x4x100-1,0x5,5x125-1,2x6,5x150-1,2x8x200 mm
 1 tournevis à lame courte pour vis à fente \bullet 0,8x4x30 mm
 4 tournevis pour vis Phillips® \oplus PH0x60-PH1x80PH2x100PH3x150 mm
 1 tournevis à lame courte pour vis Phillips® \oplus PH1x30 mm
 12 tournevis pour vis Torx® \odot T06-T07-T08-T09-T10-T15-T20-T25-T27-T30-T40-T45
 1 tournevis détecteur de tension \bullet 0,5x3,5x100 mm

Réf. Beta	TR
42	MM11
96BPC/SC9	MM11
96T	MM61
1370	MM61
1390	MM61
35	MM61
1719BMA8/S5	MM61
895/1	MM105
895/3	MM105
895/6	MM105
900	MM105
900L	MM105
900ME	MM105
900LP	MM105
900PH	MM105
900TX	MM105
900/16	MM105
900/20	MM105
900/20L	MM105
900/21	MM105
900/25	MM105
900B/30	MM105
900/42	MM105
900/55	MM105
910A	MM105
910/15	MM105
910/16	MM105
910/21	MM105
910/22	MM105
910/25	MM105
910/42	MM105
910/55	MM105
920A	MM105
920/15	MM105
920/25	MM105
920AN	MM105
920AN	MM105
920/42	MM105
920/55	MM105
956E	MM105
97TTX	MM140
1084BM	MM140
1150BM	MM140
1166BM	MM140
1032	MM140
1034	MM140
1036	MM140
1038	MM140
1048N	MM140
1052	MM140
1256/C36-2	MM140
1201E	MM210
1201EN	MM210
1202E	MM210
1202EN	MM210
1207E/TX	MM210
1253	MM210



MM11



MM61



MM105



MM140



MM210

CHF

5945VU/M

3.390.00 059451001

Composition conseillée avec C45

5954VG

Composition de 138 outils

► Réparation automobile

Quantité/Description	Réf. Beta
5 chasse-goupilles Ø 2-3-4-5-6 mm	31
1 pointeau Ø 4 mm	32
1 burins plats 125 mm	34
18 clés mixtes 6+22 - 24 mm	42
8 clés à fourches 6x7 - 8x9 - 10x11 - 12x13 - 14x15 - 16x17 - 18x19 - 20x22 mm	55
3 clés polygonales contre - coudées 12x13 - 14x15 - 17x19 mm	90
13 clés mâles 6 pans coudées Ø 2+10 - 12 mm	96
4 douilles à choc carré conducteur femelle 1/2" Ø 17 - 19 - 21 - 22 mm	720
20 douilles 6 pans avec carré conducteur femelle 1/2" Ø 10-11-12-13-14-15-16-17-18-19-20-21-22-23-24-26-27-28-30-32 mm	920A
1 rallonge - 1/2"	920/21
1 rallonge - 1/2"	920/22
1 cardan 1/2"	920/25
1 poignée coulissante 1/2"	920/42
1 cliquet réversible 1/2" Ⓢ	920/55
3 Clé à douille emmanchée, série longue Ø 8 - 10 - 13 mm	943BX
10 clés à béquille à cardan	952
Ø 6 - 7 - 8 - 10 - 11 - 12 - 13 - 14 - 17 - 19 mm	
3 douille à bougies Ø 16 - 17,8 - 20,8 mm	956C
1 pince levier à broche et à bec	964
1 pinces pour circlips intérieurs à becs droits Ⓢ	1032
1 pinces pour circlips intérieurs à becs coudés Ⓢ	1034
1 pinces pour circlips extérieurs à becs droits ●	1036
1 pinces pour circlips extérieurs à becs coudés ●	1038
1 Pince multiprise entrepassée 250 mm	1048N
1 pince - étau à becs droits 240 mm	1052
1 pince - étau à becs longs 175 mm	1058
1 Pince coupante diagonale ⚡ 160 mm	1082BM
1 ciseaux d'électricien	1128BMX
1 pince à becs demi-ronds longs = 180 mm	1150BM
1 Pince à becs demi-ronds longs ● 160 mm	1166BM
1 Tournevis détecteur de tension à pince crocodile ● 6÷24V	1254
1 tournevis pour vis à fente ● 8 x 200 mm	1260
1 tournevis à lame courte pour vis à fente ● 6,5x30 mm	1260N
1 tournevis pour vis Phillips® Ⓢ 8 x 150 mm	1262
1 tournevis à lame courte pour vis Phillips® Ⓢ PH2x30 mm	1262N
5 tournevis pour vis Torx® Ⓢ T8 - T10 - T15 - T20 - T25	1267TX
8 tournevis	1263/D8
1 marteau de mécanicien 300 g	1370
1 massette sans rebond Ø 35 mm	1392
1 pince pour ressorts de frein 210 mm	1470
1 pince à cosses non isolées	1603
1 mètre à ruban 5 m	1692
1 jauge d'épaisseur	1708/20
1 doigt magnétique flexible 1,8 kg	1712E/2
6 limes 160 mm	1720/B6
1 burette plastique 150 cc	1754



CHF

5954VG

2,930.00 059541054

Composition conseillée avec C54VG

5957VG

Composition de 174 outils

► Réparation automobile



Quantité/Description	Réf. Beta
6 chasse-goupilles Ø 2 - 3 - 4 - 5 - 6 - 8 mm	31/SP6
6 2 chasse - clous, 1 pointeau, 2 burins plats, 1 bédane, sur présentoir	38/SP6
17 clés mixtes 6-7-8-10-11-12-13-14-15-16-17-19-21-22-24-27-30 mm	42
12 clés à fourches 6x7 + 30x32 mm	55/S12X
8 clés mâles 6 pans à poignée en T 2 + 10 mm	96T/S8
1 clés mâles 6 pans coudées Ø 2,5 + 12 mm	96N/G7
8 clés mâles coudées pour vis Torx® T9 + T40	97TX/SC8
5 clé mâle coudée XZN® Ø M5 + M12	98XZN/B5
1 Clé à molette à ouverture graduée, chromée 250 mm	111E
1 clé dynamométrique à déclenchement avec cliquet réversible Ⓢ 1/2", 40+200 Nm	666N/20
13 douilles 6 pans 1/2" sur rail Ø 10+22 mm	920A/SB13
8 douilles 6 pans 1/2" sur rail Ø 23+32 mm	920A/SB8
4 douilles pour vis à fente 1/2" ● 1,2x6,5 - 1,2x8 - 1,6x9 - 2x12 mm	920LP
3 douilles pour vis Phillips® 1/2" Ⓢ PH2 - 3 - 4	920PH
1 rallonge - 1/2" 125 mm	920/21
1 rallonge - 1/2" 255 mm	920/22
1 cardan 1/2"	920/25
1 poignée coulissante 1/2"	920/42
1 cliquet réversible 1/2" Ⓢ	920/55
2 douilles à choc carré conducteur femelle 1/2" Ø 17 - 19 mm	720
10 clés à béquille à cardan Ø 7 - 8 - 10 - 11 - 12 - 13 - 14 - 15 - 17 - 19 mm	952
3 clés à bougies à cardan 14 - 16 - 20,8 mm	959
1 pince levier à broche et palette	963
1 clé en croix pour écrous de roues Ø 1/2" - 17 - 19 - 22 mm	979
2 pinces pour circlips intérieurs à becs droits Ø 140 - 180 mm	1032
2 pinces pour circlips intérieurs à becs coudés Ø 130 - 170 mm	1034
2 pinces pour circlips extérieurs à becs droits ● 140x1,3 - 175 mm	1036
2 pinces pour circlips extérieurs à becs coudés ● 135x1,3 - 175 mm	1038
1 Pince multiprise entrecroisée 250 mm	1048N
1 pince - étau à becs droits 240 mm	1052
1 Pince coupante diagonale 160 mm	1082BM
1 Pince coupante diagonale à faible effort de coupe 160 mm	1084BM
1 pince coupante frontale articulée, série lourde 180 mm	1092V
1 cisaille type américain coupe droite 250 mm	1112
1 ciseaux d'électricien	1128BMX
1 pince à becs demi-ronds longs = 180 mm	1150BM
1 Pince à becs demi-ronds longs ● 160 mm	1166BM
1 Pince à becs coudés demi-ronds ● 200 mm	1168BM
2 tournevis pour vis à fente ● 8x200 - 10x200 mm	1260
1 tournevis pour vis Phillips® Ⓢ PH3x150 mm	1262
8 tournevis	1263/D8
2 marteau de mécanicien 300 - 600 g	1370
1 marteau de mécanicien Ø 35 mm	1390
11 extracteur à rouleaux pour goujons M5+M16 mm	1433/C11
1 massette à embouts plastiques	1491
1 clé à sangle pour filtre à huile	1498
1 mètre à ruban 5 m	1692
1 jauge d'épaisseur	1708/20
1 doigt magnétique flexible 1,8 kg	1712E/2
1 grattoir feuille de sauge 200 mm	1717A
1 grattoir triangulaire 200 mm	1717B
5 limes demi-douces 200 mm	1719BMA8/S5
1 monture de scie à métaux	1725
1 burette tôle à embout flexible 200 cc	1751
1 cutter à lame sécable 18 mm avec lames	1771
1 Pied à coulisse	1650

CHF



5957VG 5,110.00 059571007

Composition conseillé en association avec C57S A - C57S B - C57SP - C55PSP

PLATEAUX THERMOFORMÉS SOUPLES



RSC23T
RSC24
RSC24A
RSC24AXL
RSC24L/7
RSC24L-CAB
RSC28
C30M
C37
C37A
C39
C39T
C39MD
C39SM
RSC51
C57S
C59
RSC55

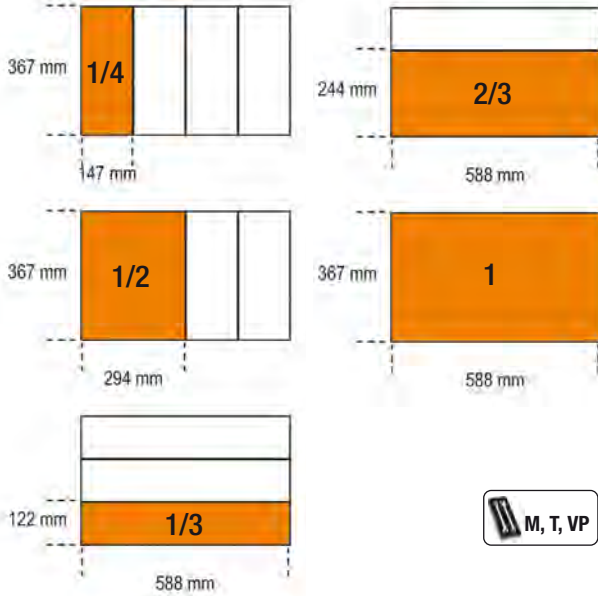

493÷503
508÷518



M01



42 6-7-8-9-10-11-12-13-14-15-16-17-18-19-20-21-22-24-27-30-32-36 mm

4,5 kg

	CHF		
M01	548.00	1	024500001
MV10	81.00	1	024510010

M02



42 6-7-8-9-10-11-12-13-14-15-16-17-18-19-20-21-22-23-24-25-26-27-28-29-30-32 mm

6,3 kg

	CHF		
M02	620.00	1	024500002
MV02	81.00	1	024510002

M05



42 6-7-8-9-10-11-12-13-14-15-16-17-18-19-20-21 mm

1,5 kg

	CHF		
M05	270.00	1	024500005
MV15	42.50	1	024510015

M06



42 22-24-27-30-32 mm

2,1 kg

	CHF		
M06	191.00	1	024500006
MV16	57.50	1	024510016

M13



42SLIM 8-10-11-12-13-14-15-16-17-18-19 mm

1,2 kg

	CHF		
M13	201.50	1	024500013
MV13	42.50	1	024510013

M25



42 6-7-8-9-10-11-12-13-14-15-16-17-18-19-21-22-24-27 mm
90 6x7-8x9-10x11-12x13-14x15-16x17-18x19 mm
123Q1/4
123Q3/8
123Q1/2
142 8-9-10-11-12-13-14-15-16-17-18-19 mm

5,1 kg

	CHF		
M25	890.00	1	024500025
MV25	81.00	1	024510873

M30



55 6x7-8x9-10x11-12x13-14x15-16x17-18x19-20x22-21x23-24x27-30x32 mm
90 6x7-8x9-10x11-12x13-14x15-16x17-18x19-20x22-21x23-24x27-30x32 mm
96BPC/SC9 1,5-2-2,5-3-4-5-6-8-10 mm

4,2 kg

	CHF		
M30	522.00	1	024500030
MV30	81.00	1	024510030



M31



42AS 1/4-9/32-5/16-3/8-7/16-1/2-9/16-19/32-5/8-11/16-3/4-13/16-7/8-15/16-1-1.1/16-1.1/8-1.1/4
96BP/AS-SC9 1/16-3/32-1/8-5/32-3/16-7/32-1/4-5/16-3/8

4,5 kg



	CHF		
M31	546.00	1	024500031
MV31	81.00	1	024510031

M33



55 6x7-8x9-10x11
12x13-14x15
16x17-18x19
20x22 mm
96/SC9 1,5+10 mm

1,1 kg



	CHF		
M33	126.50	1	024500033
MV33	42.50	1	024510033

M38



55 21x23-24x26
27x29-30x32 mm

1,7 kg



	CHF		
M38	106.50	1	024500038
MV38	57.50	1	024510038

M39



31 2-3-4-5-6-8 mm
32 4 mm
55 6x7-8x9-10x11-12x13-14x15-16x17-18x19-20x22-21x23-24x26-25x28-27x29-30x32 mm
96/SC12 2-2,5-3-3,5-4-4,5-5-6-7-8-9-10 mm
96 12-14-17-19 mm

5,7 kg



	CHF		
M39	427.00	1	024500039
MV39	81.00	1	024510039

M40



90 6x7-8x9-10x11
12x13-14x15
16x17-18x19 mm

810 g



	CHF		
M40	140.50	1	024500040
MV40	42.50	1	024510040

M44



141 8-9-10-11-12
13-14-15-16
17-18-19 mm

1,3 kg



	CHF		
M44	355.00	1	024500044
MV44	42.50	1	024510044

M45



142 8-9-10-11-12
13-14-15-16
17-18-19 mm

1,3 kg



	CHF		
M45	404.00	1	024500045
MV45	42.50	1	024510045

M46



142SN 8-9-10-11-12
13-14-15-16
17-18-19 mm

1,4 kg



	CHF		
M46	476.00	1	024500046
MV46	42.50	1	024510046

M49

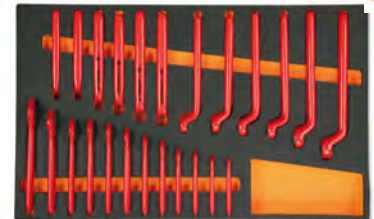

52MQ 7-8-10-11-12-13-14-15-16-17-19-22 mm
89MQ 7-8-10-11-12-13-14-15-16-17-19-22 mm

3,3 kg



	CHF		
M49	1,430.00	1	024500049
MV49	81.00	1	024510049

M50



96T 2-2,5-3-4-5
6-7-8 mm

1,1 kg



	CHF		
M50	164.50	1	024500050
MV50	57.50	1	024510051

M52



96T 2,5-3-4-5-6 mm



330 g



	CHF		
M52	97.50	1	024500052
MV52	42.50	1	024510052

M53



96TBP 2,5-3-4-5-6 mm



350 g



	CHF		
M53	103.00	1	024500053
MV52	42.50	1	024510052

M55



97TTX T10-T15-T20-T25-T30



330 g



	CHF		
M55	108.00	1	024500055
MV55	42.50	1	024510055



M60



96T 2-2,5-3-4-5-6-7-8-10 mm
 97BTX/SC8 T9-T10-T15-T20-T25-T27-T30-T40
 944BX 5-6-7-8-10-13 mm



1,9 Kg



	CHF		
M60	480.00	1	024500060
MV60	81.00	1	024510060

M62



97TTX T10-T15-T20-T25-T27-T30-T40-T45-T50
 1032 180 mm
 1034 170 mm
 1036 175 mm
 1038 175 mm
 1177BM 140 mm
 1188BM 125 mm
 1257LP 2-2,5-3-3,5 mm
 1257PH 0-00



2,3 Kg



	CHF		
M62	574.00	1	024500875
MV62	81.00	1	024510875

M63



952 7-8-10-12-13-14-17-19 mm



3,4 Kg



	CHF		
M63	435.00	1	024500063
MV63	81.00	1	024510063

M65

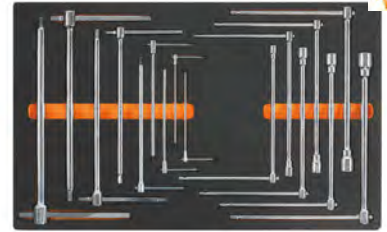

950 8-10-12-13-14-17-19 mm
 951 2,5-3-4-5-6-8-10-12-14 mm



3,6 Kg



	CHF		
M65	670.00	1	024500065
MV65	81.00	1	024510065

M67

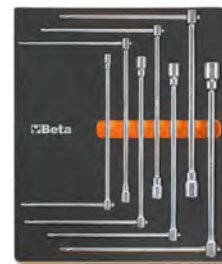

950 7-8-10-12-13-17 mm



1,8 kg



	CHF		
M67	254.00	1	024500067
MV67	57.50	1	024510067

M69



951 2,5-3-4-5-6-8-10-12-14 mm



1,8 kg



	CHF		
M69	379.00	1	024500069
MV69	57.50	1	024510069

M75



933 7-8-9-10-11-12-13-14-15-16-17-18-19-21-22-24 mm



5,5 kg



	CHF		
M75	567.00	1	024500075
MV75	81.00	1	024510075



M78



80 6x7-8x9-10x11-12x13-14x15-16x17-18x19 mm

- 920/36A
- 965 450 mm
- 1052 240 mm
- 1058 175 mm
- 1481PL/A
- 1481PL/B
- 1481PL/C
- 1650 150 mm
- 1708/20
- 1716P

4,4 kg

M78	CHF 864.00	1	024500878
MV77	CHF 81.00	1	024510876

M79



80 8x9 -10x11-12x13 -14x15 16x17-18x19 mm

1,3 kg

M79	CHF 381.00	1	024500079
MV79	CHF 42.50	1	024510079

M82



- 920A 10-11-12-13-14 15-16-17-18-19 20-21-22-23-24 26-27-30-32 mm
- 920ME 5-6-8-10-12 mm
- 920AN/125 125 mm
- 920AN/250 250 mm
- 920/25 255 mm
- 920/42 305 mm
- ⊕ 920/55

4,1 kg

M82	CHF 547.00	1	024500082
MV82	CHF 57.50	1	024510082

M83



- 920A 10-11-12-13-14 15-16-17-18-19 20-21-22-23-24 26-27-30-32 mm
- 920AN/125 125 mm
- 920AN/250 250 mm
- 920/25 255 mm
- 920/42 305 mm
- ⊕ 920/55

3,7 kg

M83	CHF 430.00	1	024500083
MV83	CHF 57.50	1	024510083

M85



- 851SR 230 mm
- 860LP 0,5x3 - 0,6x4,5 - 0,8x5,5 - 1x5,5 - 1,2x6,5 mm
- 860PE 2 - 2,5 - 3 - 4 - 5 - 6 - 8 - 10 mm
- ⊕ 860PH PH0 - PH1 - PH2 - PH3 - PH4
- ⊕ 860PZ PZ1 - PZ2 - PZ3 - PZ4
- ⊕ 860TX T6-T7-T8-T9-T10-T15-T20-T25-T27-T30-T40

- ⊕ 860RTX T9-T10-T15-T20-T25-T27-T30-T40
- 860/55 100 mm
- 882P 80 mm
- 892 ■ 1/4 - □ 1/4

450 g

M85	CHF 251.00	1	024500085
MV85	CHF 42.50	1	024510085

M86



- 867PE 4-5-6-7-8-10-12 mm
- 867PE/L 4-5-6-7-8-10-12 mm
- 867XZN 5-6-8-10-12 mm
- 867XZN/L 5-6-8-10-12 mm
- ⊕ 867TX T20-T25-T30-T40-T45-T50-T55
- ⊕ 867TX/L T25-T30-T40-T45-T50-T55
- ⊕ 867RTX T20-T25-T30-T40-T45-T50-T55
- 867/1
- 867/2

1,4 kg

M86	CHF 180.50	1	024500086
MV86	CHF 42.50	1	024510086

M91



- 900 4-4,5-5-5,5-6-7-8-9-10-11-12-13-14 mm
- 900ME 2,5-3-4-5-6-8 mm
- 900/20 50 mm
- 900/21 150 mm
- 900/25 □ 1/4 - ■ 1/4
- 900BG/30
- 900/42
- ⊕ 900/55

560 g

M91	CHF 296.00	1	024500091
MV90	CHF 42.50	1	024510090

M92



- 910A 6-7-8-9-10-11-12-13-14-15-16-17-18-19-20-21-22 mm
- 910/21 125 mm
- 910/22 250 mm
- 910/25
- 910/42
- ⊕ 910/55

1,5 kg

M92	CHF 332.00	1	024500092
MV92	CHF 42.50	1	024510092

M94



- 900AS/L 3/16-7/32-1/4-9/32-5/16-11/32-3/8-7/16-1/2-9/16
- 900AS 3/16-7/32-5/32-1/4-9/32-5/16-11/32-3/8-7/16-1/2-9/16
- 900AN 50-100mm
- 900/25
- ⊕ 900/55
- 900/42

930 g

M94	CHF 346.00	1	024500094
MV94	CHF 42.50	1	024510094

M96



- 920A/AS 3/8-7/16-1/2-9/16-19/32-5/8-11/16-3/4-25/32-13/16-7/8-15/16-1-1-1/16-1-1/8-1-3/16-1-1/4
- 920/25
- 920AN 125-250mm
- 920/42
- ⊕ 920/55

3,8 kg

M96	CHF 444.00	1	024500096
MV96	CHF 57.50	1	024510096

M100

98



- 895/1
- 895/3
- 895/6
- 900 4-4, 5-5, 5-5, 6-7, 8-9, 10-11, 12-13, 14 mm
- 900L 5-6-7-8-9-10-11-12-13 mm
- 900ME 3-4-5-6-7 mm
- 900LP 0,8x4-1x5,5-1,2x6,5-1,2x8 mm
- ⊕ 900PH PH1-PH2-PH3-PH4
- ⊕ 900TX T10-T15-T20-T25-T27-T30-T40
- 900/20 50 mm
- 900/20L 100 mm
- 900/21 150 mm
- 900/25
- 900BG/30
- 900/42
- ⊕ 900/55
- 920A 8-10-11-12-13-14-15-16-17-18-19-20
21-22-23-24-26-27-28-30-32 mm
- 920/15
- 920/25
- 920AN/125 125 mm
- 920AN/250 250 mm
- 920/42
- ⊕ 920/55
- 920FTX 10-12-14-16-18-20-22-24 mm
- 920AL 10-12-13-14-15-16-17-18-19-21-22

6,7 Kg

	14"	12"	
			CHF
M100	1,505.00	1	024500100
MV100	81.00	1	024510100



M105

116



- 900 4-4, 5-5, 5-5, 6-7, 8-9, 10-11, 12-13, 14 mm
- 900L 5-6-7-8-9-10-11-12-13 mm
- 96BPC/SC9 1,5-2-2,5-3-4-5-6-8-10 mm
- 895/1
- 895/3
- 895/6
- 900ME 3-4-5-6-7 mm
- 900LP 0,8x4-1x5,5-1,2x6,5-1,2x8 mm
- ⊕ 900PH PH1-PH2-PH3-PH4
- ⊕ 900TX T10-T15-T20-T25-T27-T30-T40
- 900/16 □ 1/4 - ■ 3/8
- 900/... 50-100-150 mm
- 900/25
- 900BG/30
- 900/42
- ⊕ 900/55
- 910A 6-7-8-9-10-11-12-13-14-15-16-17-18-19-
20-21-22 mm
- 910/15 □ 3/8 - ■ 1/4
- 910/16 □ 3/8 - ■ 1/2
- 910/21 125 mm
- 910/22 250 mm
- 910/25
- 910/42
- ⊕ 910/55
- 920A 8-10-11-12-13-14-15-16-17-18-19-20-21-
22-23-24-26-27-28-30-32 mm
- 920/15 □ 1/2 - ■ 3/8
- 920/25
- 920AN 125 - 250 mm
- 920/42
- ⊕ 920/55
- 956E 16-17,8-20,8 mm

7,7 kg

	14"	38"	12"	
				CHF
M105	1,635.00	1	024500871	
MV105	81.00	1	024510871	

M108

27



- 910MQ/PE 4-5-6-8 mm
- 910MQ/B 7-8-10-11-12-13-14-15-16-17-19 mm
- ⊕ 910MQ/TX T15-T20-T25-T27-T30-T40
- 910MQ/XZN 8-10 mm
- 910MQ/21 125 mm
- 910MQ/22 250 mm
- 910MQ/T
- 910MQ/55

2,7 kg

			CHF
M108	1,570.00	1	024500108
MV108	81.00	1	024510108

M110

36



- ⊕ 850MQ
- ⊕ 860TX/A10
- 920MQ/A 8-9-10-11-12-13-14-15-16-17-18-19-20
mm
- 920MQ/PE 5-6-8-10-12 mm
- 920MQ/21 125 mm
- 920MQ/22 250 mm
- 920MQ/55A
- 943MQ 6-7-8-10 mm

3,1 kg

			CHF
M110	1,580.00	1	024500110
MV110	81.00	1	024510110

M112

32



- ⊕ 861TX ● 1/4-T6+T15
- ⊕ 866TX ● 5/16-T20+T55
- 895/1 ○ 1/4x□1/4
- 895/6 ○ 5/16x□1/2
- ⊕ 900FTX □ 1/4-E4+E10
- ⊕ 920FTX □ 1/2-E12+E24
- ⊕ 920TX □ 1/2-T55L-T60-T70L

1,3 kg

	14"	12"	
			CHF
M112	391.00	1	024500112
MV112	42.50	1	024510112

M115

54



- ⊕ 666N/20 40+200 Nm
- 920A 13-14-15-16-17-18-19-20-21-22-24-26-
27-30-32 mm
- 920FTX 12-14-16-18-20-22-24 mm
- 920PE 6-7-8-8L-10-10L-12-12L-14-14L
- ⊕ 920TX T20-T25-T27-T30-T40-T45-T50-T55-T60-
T20L-T25L-T27L-T30L-T40L-T45L-T50L
- 920/21 125 mm
- 920/22 255 mm
- 920/25
- 920/42 305 mm
- ⊕ 920/55

7,8 Kg

			CHF
M115	1,445.00	1	024500115
MV115	81.00	1	024510115

M120

75



- 920A 10-11-12-13-14-15-16-17-18-19-20-21-22-24-26-27-30-32 mm
- 920AN/125 125 mm
- 920AN/250 250 mm
- 920/25
- 920/42
- 920AL 10-12-13-14-15-16-17-18-19-22-24-27-30-32 mm
- ⊗ 920FTX 10-12-14-16-18-20-22-24 mm
- ⊗ 920/55
- 920PE 5-5L-6-6L-7-7L-8-8L-10-10L-12-12L-14-14L
- ⊗ 920TX T20-T25-T27-T30-T40-T45-T50-T55-T60-T20L-T25L-T27L-T30L-T40L-T45L-T50L

6,9 Kg

12"



	CHF		
M120	1,610.00	1	024500120
MV120	81.00	1	024510120

M121

46



- 920BP 5L-6L-8L-10L-5XL-6XL-8XL mm
- ⊗ 920TX T20-T25-T27-T30-T40L-T45L-T50L-T55L-T60L-T70L
- 920XZN 4-5-6-6L-8-8L-10-10L-12-12L-14-14L-16-18 mm
- ⊗ 920ES 7-9-10-11-12L-14L-16L-7XL-9XL-10XL-11XL-12XL-14XL-16XL mm
- 920/36A

6,3 Kg

12"



	CHF		
M121	1,520.00	1	024500121
MV121	81.00	1	024510121

M125

68



- 910AL 8-9-10-11-12-13-14-15-16-17-19-21-22 mm
- 920PE 5-6-6L-7-8-8L-10-10L-12-12L mm
- ⊗ 920FTX E12-E14-E16-E18-E20-E22-E24
- ⊗ 920TX T20-T25-T27-T30-T30L-T40-T40L-T45-T50-T50L-T55-T60-T60L
- 920XZN 5-6-6L-8-8L-10-10L-12L mm
- 920AL 10-12-13-14-15-16-17-18-19-21-22-23-24-27-30-32 mm
- 1692/5 5 m

7,9 kg

38" 12"



	CHF		
M125	1,585.00	1	024500872
MV125	81.00	1	024510872

M126

26



- 928A 19-21-22-24-26-27-28-30-32-34-35-36-38-41-46 mm
- 928ME 14-17-19-22 mm
- 928/15 □ 3/4 - ■ 1/2
- 928/16 □ 3/4 - ■ 1
- 928/21 200 mm
- 928/22 380 mm
- 928/25 450 mm
- 928/42 450 mm
- ⊗ 928/55

12,4 kg

34"



	CHF		
M126	1,200.00	1	024500126
MV126	81.00	1	024510126

M127

23



- 728 19-21-22-24-27-30-32-33-34-35-36-38-40-41-46
- ⊗ 728FTX 20-22-24 mm
- 728/15 □ 3/4 - ■ 1/2
- 728/16 □ 3/4 - ■ 1
- 728/21 175 mm
- 728/22 250 mm
- 728/25

12,5 kg

34"



	CHF		
M127	1,162.00	1	024500127
MV127	81.00	1	024510127

M128

50

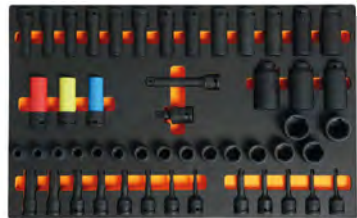

- 720 10-11-12-13-14-15-16-17-18-19-21-22-24-27-30-32 mm
- 720L 10-11-12-13-14-15-16-17-18-19-21-22-24-27-30-32 mm
- ⊗ 720TX T30-T40-T45-T50-T55
- 720ME 5-6-8-10-12-14-17-19 mm
- 720LC 17-19-21 mm
- 720/21 125 mm
- 720/25

8,9 kg

12"



	CHF		
M128	1,179.00	1	024500128
MV128	81.00	1	024510128

M129

13



- 1032 180 mm
- 1034 170 mm
- 1036 175 mm
- 1038 175 mm
- 1048N 250 mm
- 1052 240 mm
- ⊗ 1082BM 160 mm
- 1098 220 mm
- 1112 250 mm
- 1128BM
- 1150BM 180 mm
- 1166BM 160 mm
- 1168BM 160 mm

3,4 Kg

CHF



	CHF		
M129	563.00	1	024500129
MV138	81.00	1	024510138

M133

3



- ⊗ 1082G 160 mm
- 1150G 180 mm
- 1166G 160 mm

650 g

CHF



	CHF		
M133	105.50	1	024500133
MV133	42.50	1	024510133

M134

3



- ⊗ 1082GBM 160 mm
- 1150GBM 180 mm
- 1166GBM 160 mm

750 g

CHF



	CHF		
M134	134.00	1	024500134
MV134	42.50	1	024510134

M135



- 1082MQ 160 mm
- 1150MQ 180 mm
- 1166MQ 160 mm

750 g



	CHF		
M135	226.50	1	024500135
MV135	42.50	1	024510135

M136



- 1084BM 160 mm
- 1150BM 180 mm
- 1166BM 160 mm

750 g



	CHF		
M136	152.50	1	024500136
MV131	42.50	1	024510131

M137



- 1084 160 mm
- 1150 180 mm
- 1166 160 mm

650 g



	CHF		
M137	124.50	1	024500137
MV132	42.50	1	024510132

M145



- 1032 180 mm
- 1034 170 mm
- 1036 175 mm
- 1038 175 mm

640 g



	CHF		
M145	167.50	1	024500145
MV145	42.50	1	024510145

M153



- 1048N 250 mm
- 1052 240 mm

1 kg



	CHF		
M153	121.00	1	024500153
MV154	42.50	1	024510154

M161



- 1128MQ
- 1048MQ 250 mm
- 1082MQ 160 mm
- 1150MQ 180 mm
- 1162MQ 160 mm
- 1164MQ 160 mm
- 1272MQ PH0x60 - PH1x80 - PH2x100 - PH3x150 mm
- 1274MQ 2,5x75 - 3x100 - 4x100 - 5,5x125 mm
- 1777MQ/U

3,0 kg



	CHF		
M161	657.00	1	024500161
MV161	81.00	1	024510161

M162



- 1241 5,5x100-6,5x125-8x150-10x200 mm
- 1242 PH1x100-PH2x100-PH3x150-PH4x200 mm

1,4 kg



	CHF		
M162	184.50	1	024500162
MV162	57.50	1	024510162

Beta

Quality Tools

M166



860MIX/A31

- 1048N 250 mm
- 1082BM 160 mm
- 1150BM 180 mm
- 1162BM 160 mm
- 1290 3x75-4x100-5,5x100-6,5x150-8x150 mm
- 1290N 6,5x30 mm
- 1292 4,5x80-6x100-8x150 mm
- 1292N 6x30 mm
- 1297TX T20-T25-T27-T30

2,9 kg



	CHF		
M166	574.00	1	024500879
MV880	81.00	1	024510880

M170



- 1290 2,5x50
- 3x75
- 3,5x100
- 4x125
- 5,5x100
- 5,5x150
- 6,5x150 mm

500 g



	CHF		
M170	97.50	1	024500170
MV170	42.50	1	024510170

M172



- 1292 PH0x60
- PH0x100
- PH1x80
- PH1x120
- PH2x100
- PH2x150 mm

450 g



	CHF		
M172	88.50	1	024500172
MV172	42.50	1	024510172



M174



450 g

1297TX T8-T10-T15-T20-T25-T30

M174	CHF 130.00	1	024500174
MV174	CHF 42.50	1	024510174

M180



500 g

1290 3x75
4x100
5,5x150
6,5x150 mm
1292 PH0x60
PH1x80
PH2x100 mm

M180	CHF 101.50	1	024500180
MV180	CHF 42.50	1	024510180

M195



2,3 kg

1260 2,5x50-3x75-4x100-5,5x125-6,5x150-8x200 mm
1260N 4x30 mm
1262 PH0x60-PH1x80-PH2x100-PH3x150 mm
1262N PH1x30 mm
1267TX T6-T7-T8-T9-T10-T15-T20-T25-T27-T30-T40-T45
1253 3,5x100 mm

M195	CHF 401.00	1	024500195
MV195	CHF 81.00	1	024510195

M201



500 g

1260 3x75-4x100-6,5x150 mm
1262 PH0x60-PH1x80-PH2x100 mm

M201	CHF 101.50	1	024500201
MV201	CHF 42.50	1	024510201

M204



450 g

1267TX T8-T10-T15-T20-T25-T30

M204	CHF 101.50	1	024500204
MV204	CHF 42.50	1	024510204

M208



750 g

1260 3x75
3,5x100
4x125
5,5x150
6,5x150 mm
1262 PH0x60
PH1x80
PH2x100 mm
1260N 4x30 mm
1262N PH1x30 mm

M208	CHF 116.50	1	024500208
MV208	CHF 57.50	1	024510208

M209



820 g

1260N 4x30 mm
1264 2,5x60 - 3x100 - 4x125 - 5x150 - 6,5x150 mm
1262 PH0x60 - PH1x80 - PH2x100 mm
1262N PH1x30 mm

M209	CHF 114.50	1	024500209
MV208	CHF 57.50	1	024510208

M213



1,8 Kg

1201E 2,5x50-3x75-4x100-5,5x125-6,5x150-8x200 mm
1201EN 4x30 mm
1202E PH0x60-PH1x80-PH2x100-PH3x150 mm
1202EN PH1x30 mm
1207E/TX T6-T7-T8-T9-T10-T15-T20-T25-T27-T30-T40-T45
1253 3,5x100 mm

M213	CHF 274.00	1	024500213
MV210	CHF 81.00	1	024510210

M214



500 g

1201E 2,5x50-3x75-3,5x100-4x125-5,5x100-5,5x150-6,5x150 mm

M214	CHF 57.00	1	024500214
MV211	CHF 42.50	1	024510211

M216



450 g

1202E PH0x60-PH1x80-PH1x120-PH2x100-PH2x150-PH3x150 mm

M216	CHF 61.50	1	024500216
MV212	CHF 42.50	1	024510212

M217



500 g

1207E/TX T6-T7-T8-T9-T10-T15-T20

M217	CHF 78.50	1	024500217
MV215	CHF 42.50	1	024510215



M218



- 1201E 3x75
4x100
5,5x150
6,5x150 mm
- ⊕ 1202E PH0x60
PH1x80
PH2x100 mm

500 g



	CHF		
M218	60.00	1	024500218
MV220	42.50	1	024510220

M219



- ⊕ 1202E 3x60 - 4,5x80 - 6x100 mm
- 1204E 3x75 - 4x100 - 5x150 - 6,5x150 mm

590 g



	CHF		
M219	59.50	1	024500219
MV220	42.50	1	024510220

M222



- ⊕ 1272MQ PH0x60 mm
- ⊕ 1272MQF PH1x80 - PH2x100 mm
- 1274MQF 3,5x100 - 4,5x100 - 5,5x125 - 6,5x150 mm

540 g



	CHF		
M222	170.00	1	024500222
MV222	42.50	1	024510222

M226



- 1274MQ 3x100
4x100
5,5x125
6,5x150 mm
- ⊕ 1272MQ PH0x60
PH1x80
PH2x100 mm

500 g



	CHF		
M226	130.00	1	024500226
MV226	42.50	1	024510226

M227



- 944BX 6-7-8-10-13 mm

420 g



	CHF		
M227	160.50	1	024500227
MV227	42.50	1	024510227

M230



- 30 Ø 2-3-4 mm
- 31 Ø 2-3-4-5-6-8 mm
- 32 Ø 4 mm
- 34 150 mm
- 35 200-250 mm
- 36 125 mm
- 1370 500 g
- 1390 Ø 35 mm
- 1692 3 m
- 1712TF
- 1719BMA/Q 200 mm
- ▲ 1719BMA/T 200 mm
- 1719BMA/P 200 mm
- ▶ 1719BMA/M 200 mm
- 1719BMA/R 200 mm
- 1737NX
- 1771 18 mm

3,2 Kg



	CHF		
M230	520.00	1	024500230
MV230	81.00	1	024510230



M231



- 31 2-3-4-5-6-8 mm
- 32 4 mm
- 34 125-150-175 mm
- 36 125 mm
- 1370 500-1000 g
- 1390 Ø 35 mm
- 1712TF 590 mm
- 1715 670 mm
- 1719BMA8/Q 200 mm
- ▲ 1719BMA8/T 200 mm
- 1719BMA8/P 200 mm
- ▶ 1719BMA8/M 200 mm
- 1719BMA8/R 200 mm
- 1737NX

4,7 kg



	CHF		
M231	501.00	1	024500877
MV231	81.00	1	024510877

M234



- 35 100-200 mm
- 1370 300 g
- 1390 Ø 35 mm

1,3 kg



	CHF		
M234	131.00	1	024500234
MV232	42.50	1	024510232

M236



- 1719BMA/Q 200 mm
- ▲ 1719BMA/T 200 mm
- 1719BMA/P 200 mm
- ▶ 1719BMA/M 200 mm
- 1719BMA/R 200 mm

870 g



	CHF		
M236	130.00	1	024500236
MV236	42.50	1	024510236

M237



35 100-200 mm
1370T 300 mm
1390N Ø 35 mm

1,3 kg



M237	CHF 142.00	1	024500237
MV232	CHF 42.50	1	024510232

M240



31BM Ø 2-3-4-5-6-8 mm
32 Ø 4 mm

850 g



M240	CHF 170.00	1	024500240
MV240	CHF 42.50	1	024510240

M264



1491 Ø 65+110 mm
■ 1494 ■ 10 mm
○ 1494E ○ 8-9-10-11-12-14-17 mm
○ 1494Q ○ 8-9,5-12-13 mm
△ 1494T △ 9,5
○ 1494XZN ○ 16
1496C ■ 8x ■ 10 mm

2,1 kg



M264	CHF 303.00	1	024500264
MV264	CHF 42.50	1	024510264

M284



1128BMX
1130BMX
■ 1719BMA...Q 200 mm
▲ 1719BMA...P 200 mm
▶ 1719BMA...M 200 mm
● 1719BMA...R 200 mm
1726BM 400 mm
1728BM (5)
1771BM 170 mm
1778V18 185 mm

2,4 Kg



M284	CHF 308.00	1	024500284
MV284	CHF 81.00	1	024510284

M285



1112 250 mm
1128BM
1726 440 mm
1728BM (5)
1753 200 cc

1,5 kg



M285	CHF 160.50	1	024500285
MV285	CHF 81.00	1	024510285

M289



1692 5 m
1725CR
1755 30 cc
1771

500 g



M289	CHF 65.00	1	024500289
MV289	CHF 42.50	1	024510289

M292



111E 250 mm
1128BMX
1692/5 5 m
1771 170 mm

500 g



M292	CHF 145.50	1	024500292
MV293	CHF 42.50	1	024510293

M295



1650
1682 L=300 mm
1707
1708/20

450 g



M295	CHF 149.50	1	024500295
MV295	CHF 42.50	1	024510295

M305



1927B
○ 720 12-13-14-15-16-17
18-19-21-22
24-27 mm
720/21

4,2 kg



M305	CHF 518.00	1	024500305
MV305	CHF 57.50	1	024510305

M310



1927CD
○ 720 12-13-14-15-16-17
18-19-21-22
24-27 mm
720/21

4,0 kg



M310	CHF 781.00	1	024500310
MV310	CHF 57.50	1	024510310

Beta

M400



3932U	
3935	120 mm
3937	170 mm
3952	13-14-15-16-17-18-19 mm
<input type="checkbox"/> 3961 3,2	
<input type="checkbox"/> 3961 3,3	
<input type="checkbox"/> 3961 3,5	
<input type="checkbox"/> 3961U	3,2 - 4,0 mm
3969	200 mm (x2)
3969K3	113 mm
3973/1	
3973/2	
3973/3	
3973/4	
3984/1	Ø35 mm
3984/2	Ø22,8 mm
3984/3	Ø23,5 mm
3984/4	Ø23 mm
3991	222 mm
3992	234 mm

3,1 kg



	CHF		
M400	768.00	1	024500400
MV400	81.00	1	024510400

M401

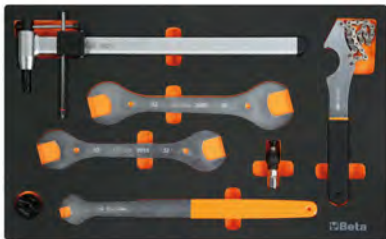

3921	440 mm
3948	
3953	
3955	30x32 - 32x36 mm
3967	289 mm
3971	

2,7 kg



	CHF		
M401	461.00	1	024500401
MV401	81.00	1	024510401

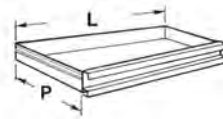

RSC22
RSC23
RSC23C
C27S

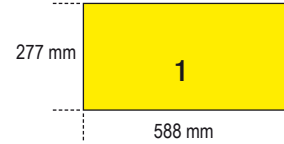
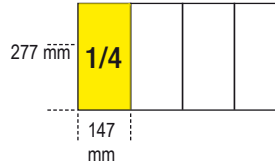

503
518

C41S
C41H



503

MC10



42	6-7-8-9-10-11-12 13-14-15-16-17 18-19-21-22 mm
○96/SC9	1,5-2-2,5-3-4-5-6-8-10 mm
≡ 1084BM	160 mm
≡ 1150G	180 mm
● 1166G	160 mm
● 1201E	3,5x100-5,5x150-6,5x150 mm
⊕ 1202E	PH0x60-PH1x80-PH2x100 mm

3,5 kg



	CHF		
MC10	490.00	1	027500011
MCV10	57.50	1	027510010

MC12



42	6-7-8-9-10-11-12-13-14-15-16-17-18-19-21-22 mm
○96/SC9	1,5-2-2,5-3-4-5-6-8-10 mm
1692/5	5 m

2,2 kg



	CHF		
MC12	325.00	1	041500012
MCV11	57.50	1	041510011

MC20



860MIX/A31	
895/1	
1048N	250 mm
1370	300 g
32	Ø 4 mm
36	Ø 4 mm
900	4-4,5-5-5,5-6-7-8-9-10-11-12-13-14 mm
900/21	150 mm
900/25	
900BG/30C	
900/42	
900/55	
920A	10-11-12-13-14-15-16-17-18-19-21-22-24-27-30-32 mm
920/25	
920AN/125	125 mm
920/42	
920/55	

6 kg



	CHF		
MC20	761.00	1	027500020
MCV20	57.50	1	027510021

MC21



○ 920A	10-11-12-13-14-15-16-17-18-19-20-21-22-23-24-26-27-30-32 mm
920/25	
920/42	
● 920/55	
920AN	125-250 mm

4,3 kg



	CHF		
MC21	430.00	1	041500021
MCV21	57.50	1	041510021



C35

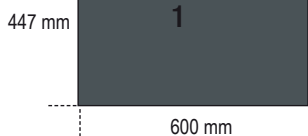

504÷506



MB12

30



- 42 6-7-8-9-10-11-12-13-14-15-16-17-18-19-20-21-22-24-27-30-32 mm
- 55 6x7-8x9-10x11
12x13-14x15
16x17-18x19
20x22 mm
- 1048N 250 mm

5,4 kg



MB12	CHF 734.00	1	024504212
MBV13	222.00	1	024524213

MB38

80



- 96T 2-2,5-3-4-5-6-7-8 mm
- 851SR 230 mm
- 860LP 0,5x3 - 0,6x4,5 - 0,8x5,5 - 1x5,5 - 1,2x6,5 mm
- 860PE 2 - 2,5 - 3 - 4 - 5 - 6 - 8 - 10 mm
- 860PH PH0 - PH1 - PH2 - PH3 - PH4
- 860PZ PZ1 - PZ2 - PZ3 - PZ4
- 860RTX T9-T10-T15-T20-T25-T27-T30-T40
- 860TX T6-T7-T8-T9-T10-T15-T20-T25-T27-T30-T40
- 860/55 100 mm
- 882P
- 892/0
- 920/21 10-11-12-13-14-15-16-17-18-19-20-21-22-23-24-26-27-30-32 mm
- 920/21 125 mm
- 920/22 255 mm
- 920/25
- 920/42
- 920/55
- 1084BM 160 mm
- 1150BM 180 mm
- 1166BM 160 mm

5,9 kg



MB38	CHF 997.00	1	024504238
MBV35	222.00	1	024524235

MB39

39



- 920A 10-11-12-13-14-15-16-17-18-19-20-21-22-23-24-26-27-30-32 mm
- 920/21 125 mm
- 920/22 255 mm
- 920/25
- 920/42
- 920/55
- 920PE 5-6-8-10-12 mm
- 1032 180 mm
- 1034 170 mm
- 1036 175 mm
- 1038 175 mm
- 35 200 mm
- 1084BM 160 mm
- 1150BM 180 mm
- 1166BM 160 mm
- 1370 500 g
- 1390 35 mm

7,2 kg



MB39	CHF 966.00	1	024504239
MBV36	222.00	1	024524236

MB44

34



- 1260 2,5x50-3x75-3,5x100-4x100-5,5x125-6,5x150-8x200 mm
- 1260N 4x30-6,5x30 mm
- 1262 PH0x60-PH0x100-PH1x80-PH1x120-PH2x100-PH2x150-PH3x150 mm
- 1262N PH1x30-PH2x30 mm
- 1253
- 96BPC/SC9
- 951 2,5-3-4-5-6-8 mm

2,8 kg



MB44	CHF 495.00	1	024504244
MBV44	222.00	1	024524244

Beta

Quality Tools

MB37

52



- 920A 10-11-12-13-14-15-16-17-18-19-20-21-22-23-24-26-27-30-32 mm
- 920/21 125 mm
- 920/22 150 mm
- 920/25
- 920/42
- 920/55
- 111E 250 mm
- 1052 240 mm
- 1084BM 160 mm
- 1150BM 180 mm
- 1166BM 160 mm
- 1032 180 mm
- 1034 170 mm
- 1036 175 mm
- 1038 175 mm
- 900 4,5-5-5,5-6-7-8-9-10-11-12-13-14 mm
- 900/20 50 mm
- 900/21 150 mm
- 900/25
- 900BG/30
- 900/55
- 900/42

7,0 kg



MB37	CHF 1,143.00	1	024504237
MBV40	222.00	1	024524240

Beta

MB45

29



- 1260 2,5x50-3x75-3,5x100-4x100-5,5x100-5x125-6,5x150 mm
- ⊕ 1262 PH0x60-PH0x100-PH1x80-PH1x120-PH2x100-PH2x150 mm
- ⊗ 1267TX T8-T10-T15-T20-T25-T30
- 1052 240 mm
- 96BPC/SC9

2,8 kg



	CHF		
MB45	368.00	1	024504245
MBV45	222.00	1	024524245

MB46

29



- 1260 3x75-4x100-5,5x125-6,5x150 mm
- ⊕ 1262 PH0x60-PH1x80-PH2x100 mm
- ⊗ 1267TX T8-T10-T15-T20-T25-T30
- 96BPC/SC9
- 96T 2-2,5-3-4-5-6
- 1052 240 mm

2,8 kg



	CHF		
MB46	410.00	1	024504246
MBV46	222.00	1	024524246

MB47

48



- 1260 3x75-4x100-5,5x125-6,5x150 mm
- ⊕ 1262 PH0x60-PH1x80-PH2x100 mm
- 1260N 4x30 mm
- ⊕ 1262N PH1x30 mm
- 96T 2,5-3-4-5-6-8 mm
- 96BPC/SC9
- 920A 10-11-12-13-14-15-16-17-18-19-20-21-22-23-24-26-27-30-32 mm
- 920/21 125 mm
- 920/22 250 mm
- 920/25
- 920/42
- ⊗ 920/55

5,6 kg

12"



	CHF		
MB47	790.00	1	024504247
MBV47	222.00	1	024524247

MB56

15



- 1719BMA/Q 200 mm
- ▲ 1719BMA/T 200 mm
- 1719BMA/P 200 mm
- ▶ 1719BMA/M 200 mm
- 1719BMA/R 200 mm
- 1032 180 mm
- 1034 170 mm
- 1036 175 mm
- 1038 175 mm
- 1370T 300 g
- 1390N Ø 35 mm
- 35 200 mm
- 1692 5 mt
- 1725CR 260 mm
- 1771 18 mm

3,7 kg



	CHF		
MB56	469.00	1	024504256
MBV56	222.00	1	024524256

MB58

17



- 31 Ø 2-3-4-5-6 mm
- 32 Ø 4 mm
- 35 200 mm
- 1112 250 mm
- 1128BMX
- 1370 500 g
- 1390 Ø 45 mm
- 1719BMA...Q 200 mm
- ▲ 1719BMA...T 200 mm
- 1719BMA...P 200 mm
- ▶ 1719BMA...M 200 mm
- 1719BMA...R 200 mm
- 1726 440 mm

4,5 kg



	CHF		
MB58	469.00	1	024504258
MBV55	222.00	1	024524255

Beta

Quality Tools

MB59

15



- 1719BMA...Q 200 mm
- ▲ 1719BMA...T 200 mm
- 1719BMA...P 200 mm
- ▶ 1719BMA...M 200 mm
- 1719BMA...R 200 mm
- 31 Ø 4-6 mm
- 32 Ø 4 mm
- 35 125-200 mm
- 1370 300 g
- 1390 Ø 35 mm
- 1692 5 mt
- 1725 420 mm
- 1833XS/2

3,4 kg



	CHF		
MB59	392.00	1	024504259
MBV57	222.00	1	024524257

MB65

16



- 1719BMA...Q 200 mm
- 1719BMA...P 200 mm
- 1719BMA...T 200 mm
- 1719BMA...M 200 mm
- 1719BMA...R 200 mm
- 35 200 mm
- 1032 180 mm
- 1034 170 mm
- 1036 175 mm
- 1038 175 mm
- 1052 240 mm
- 1084BM 160 mm
- 1150BM 180 mm
- 1166BM 160 mm
- 1370 500 g
- 1390 Ø 35 mm

4,8 kg



	CHF		
MB65	608.00	1	024504265
MBV61	222.00	1	024524261

Beta

Quality Tools

MB63



- 96BPC/SC9
- 1250 4x125 mm
- ⊕ 1251 PH1x125 mm
- 1253
- 943MQ 5,5-6-7-8-10-13 mm
- ⊕ 1272MQ PH0x60-PH1x80-PH2x100-PH3x150 mm
- 1274MQ 2,5x75-3x100-4x100-5,5x125-6,5x150-8x175 mm
- 860LP 0,5x3 - 0,6x4 - 0,8x5,5
1,0x5,5 - 1,2x6,5 mm
- 860PE 2 - 2,5 - 3 - 4 - 5 - 6
8 - 10 mm
- ⊕ 860PH PH0 - PH1 - PH2 - PH3 - PH4
- ⊕ 860PZ PZ1 - PZ2 - PZ3 - PZ4
- ⊕ 860RTX T9 - T10 - T15 - T20
T25 - T27 - T30 - T40
- 882MSR 50 ○ 1/4 ● 1/4
- 850MQ

3,2 kg

	CHF	
MB63	634.00	1 024504263
MBV63	222.00	1 024524263

MB64



- 55 6x7-8x9-10x11
12x13-14x15
16x17-18x19
20x22 mm
- 1048MQ 250 mm
- 1082MQ 140 mm
- 1128BSX
- 1132MQ 230 mm
- 1142MQ 160 mm
- 1150MQ 180 mm
- 1166MQ 160 mm
- 1168MQ 160 mm
- 110MQ 250 mm
- 1777MQ
- 993MQ
- 1602

4,1 kg

	CHF	
MB64	1,053.00	1 024504264
MBV62	222.00	1 024524262

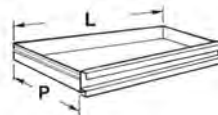

C45PRO

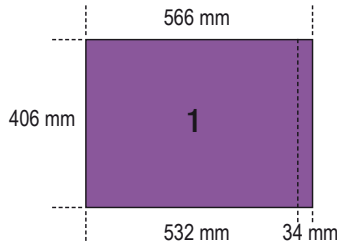

506

MM11



- 42 6-7-8-9-10-11-12-13-14-15-16-17-18-19-20-21-22-24-27-30-32 mm
- 96BPC/SC9 1,5-2-2,5-3-4-5-6-8-10 mm

4,5 kg

	CHF	
MM11	510.00	1 024580011
MMV10	81.00	1 024590010

MM61

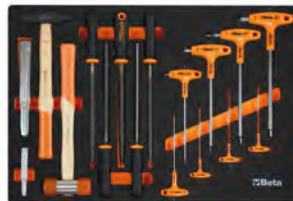

- 96T 2-2,5-3-4-5-6-7-8 mm
- 1390 Ø 35
- 1370 300 g
- 35 100-200 mm
- 1719BMA8/S5 200 mm

2,9 kg

	CHF	
MM61	410.00	1 024580061
MMV61	81.00	1 024590061

MM63



- 952 7-8-10-12-13-14-17-19 mm

3,4 kg

	CHF	
MM63	467.00	1 024580063
MMV63	81.00	1 024590063

MM105



- 895/1 ○ 1/4 □ 1/4
- 895/3 ○ 1/4 □ 3/8
- 895/6 ○ 5/16 □ 1/2
- 900 4-4,5-5-5,5-6-7-8-9-10-11-12-13-14 mm
- 900L 5-6-7-8-9-10-11-12-13 mm
- 900ME 3-4-5-6-7 mm
- 900LP 0,8x4-1x5,5-1,2x6,5-1,2x8
- ⊕ 900PH PH1-PH2-PH3-PH4
- ⊕ 900TX T10-T15-T20-T25-T27-T30-T40
- 900/16
- 900/... 50-100-150 mm
- 900/25
- 900BG/30 176 mm
- 900/42 115 mm
- 900/55 125 mm
- 910A 6-7-8-9-10-11-12-13-14-15-16-17-18-19-20-21-22 mm
- 910/15 □ 3/8 ■ 1/4
- 910/16 □ 3/8 ■ 1/2
- 910/21 125 mm
- 910/22 250 mm
- 910/25
- 910/42 210 mm
- 910/55 200 mm
- 920A 8-10-11-12-13-14-15-16-17-18-19-20-21-22-23-24-26-27-28-30-32 mm
- 1/2 ■ 3/8
- 920/15
- 920/25
- 920AN 125-250 mm
- 920/42 305 mm
- 920/55 275 mm
- 956E 16 mm (5/8")-17,8 (11/16")-20,8 (13/16")

7,2 kg

	CHF	
MM105	1,580.00	1 024580105
MMV105	81.00	1 024590105



MM140

52



- 97TTX T10-T15-T20-T25-T30
- 1084BM 160 mm
- 1150BM 180 mm
- 1166BM 160 mm
- 1032 180 mm
- 1034 170 mm
- 1036 175 mm
- 1038 175 mm
- 1048N 250 mm
- 1052 240 mm
- 1256/C36-2

2,2 kg



	CHF		
MM140	609.00	1	024580141
MMV142	81.00	1	024590142

MM210

25



- 1201E 2,5x50-3x75-4x100-5,5x125-6,5x150-8x200 mm
- 1201EN 4x30 mm
- 1202E PH0x60-PH1x80-PH2x100-PH3x150 mm
- 1202EN PH1X30 mm
- 1207E/TX T6-T7-T8-T9-T10-T15-T20-T25-T27-T30-T40-T45
- 1253

2,1 kg



	CHF		
MM210	274.00	1	024580211
MMV210	81.00	1	024590210



MM400

29



- 3932U
- 3935 120 mm
- 3937 170 mm
- 3952 13-14-15-16-17-18-19 mm

- 3961 3,2
- 3961 3,3
- 3961 3,5
- 3961U 3,2 - 4,0 mm
- 3969 200 mm (x2)
- 3969K3 113 mm

- 3973/1
- 3973/2
- 3973/3
- 3973/4
- 3984/1
- 3984/2
- 3984/3
- 3984/4
- 3991 222 mm
- 3992 234 mm

3,1 kg



	CHF		
MM400	768.00	1	024580400
MMV400	81.00	1	024590400

MM401

7



- 3921 440 mm
- 3948
- 3953
- 3955 30x32 mm - 32x36 mm
- 3967 289 mm
- 3971

2,7 kg



	CHF		
MM401	461.00	1	024580401
MMV401	81.00	1	024590401

VPM0

plateau thermoformé souple



	CHF		
VPM0	33.50	1	088870350

VPM3

plateau thermoformé souple avec 4 bacs de rangement

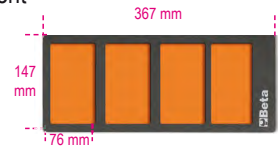

	CHF		
VPM3	33.50	1	088870353

VPM7

plateau thermoformé souple avec 3 bacs de rangement

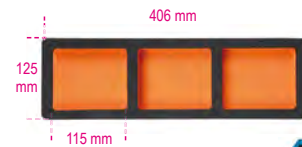

	CHF		
VPM7	35.50	1	088870356

VPM8

plateau thermoformé souple



	CHF		
VPM8	27.00	1	088870357

VPM9

plateau thermoformé souple



	CHF		
VPM9	26.50	1	088870358

VPM7-C

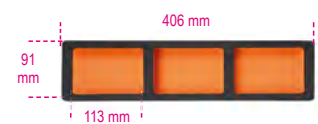

	CHF		
VPM7-C	41.50	1	088870360



Plateaux thermoformés rigides série T



Compositions d'outils en plateaux thermoformés pour tous les modèles de servantes et coffres et pour les chariots.

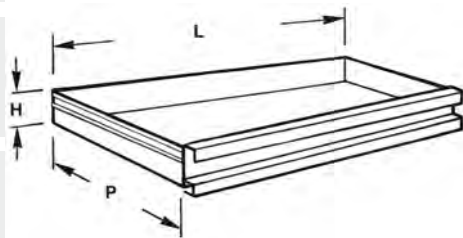

H	LxP
mm	mm
70	588x367

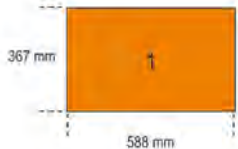
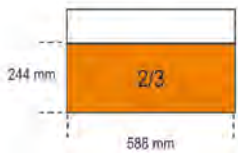
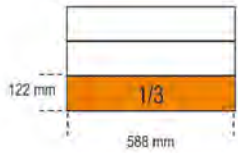
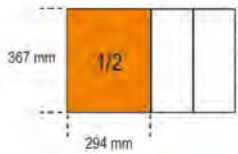
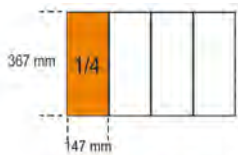

T01



42 6-7-8-10-11-12-13
14-16-17-18-19-21
22-24-27-30 mm

2,7 kg

	CHF		
T01	334.00	1	024240001
TV10	42.00	1	024000400

T05



42 6-7-8-9-10-11-12
13-14-15-16-17
18-19-20-21 mm

1,5 kg

	CHF		
T05	254.00	1	024240005
TV15	31.50	1	024000445

T06



42 22-24-27-30-32 mm

2,1 kg

	CHF		
T06	180.50	1	024240006
TV16	31.50	1	024000446

T13



42SLIM 8-10-11-12
13-14-15-16-17
18-19 mm

1,5 kg

	CHF		
T13	190.50	1	024240013
TV13	31.50	1	024249913

T18



42MP 6-7-8-9-10-11-12
13-14-15-16-17
18-19-20-21 mm

1,5 kg

	CHF		
T18	371.00	1	024240018
TV15	31.50	1	024000445

T19



42MP 22-24-27-30-32 mm

2,1 kg

	CHF		
T19	244.00	1	024240019
TV16	31.50	1	024000446

T22



42AS 5/16-3/8-7/16-1/2
9/16-5/8-11/16-3/4
96AS/BG7 3/32-1/8-5/32-3/16
1/4-5/16-3/8

1 kg

	CHF		
T22	199.50	1	024240022
TV20	31.50	1	024000488

T23



42INOX 8-10-11-12-13-14-15-
17-19 mm
96BPINOX 2,5-3-4-5-6-8-10 mm

1 kg

	CHF		
T23	339.00	1	024240023
TV23	31.50	1	024249906

T31



31 Ø 2-3-4-5-6 mm
 32 Ø 4 mm
 55 6x7-8x9-10x11
 12x13-14x15
 16x17-18x19
 20x22-21x23
 24x26-27x29
 30x32 mm
 ○ 96N/SC9 1,5+10 mm

3 kg



	CHF		
T31	280.00	1	024240031
TV30	42.00	1	024000401

T33



55 6x7-8x9-10x11
 12x13-14x15
 16x17-18x19
 20x22 mm
 ○ 96/SC9 1,5+10 mm

1 kg



	CHF		
T33	119.50	1	024240033
TV20	31.50	1	024000488

T34



55MP 6x7-8x9-10x11
 12x13-14x15
 16x17-18x19
 20x22 mm
 ○ 96/SC9 1,5+10 mm

1 kg



	CHF		
T34	151.00	1	024240034
TV20	31.50	1	024000488

T40



90 6x7-8x9-10x11
 12x13-14x15
 16x17-18x19 mm

810 g



	CHF		
T40	131.50	1	024240040
TV40	31.50	1	024000456

T41



90 20x22-21x23
 24x26-25x28
 27x29 mm

1,5 kg



	CHF		
T41	195.50	1	024240041
TV41	31.50	1	024000457

T45



142 8-9-10-11-12
 13-14-15-16
 17-18-19 mm

1,3 kg



	CHF		
T45	392.00	1	024240045
TV45	31.50	1	024000498

T46



142SN 8-9-10-11-12
 13-14-15-16
 17-18-19 mm

1,5 kg



	CHF		
T46	465.00	1	024240046
TV46	31.50	1	024000499

T48



○ 96BPC/SC9 1,5+10 mm
 142C 8-9-10-11-12
 13-14-15-16
 17-18-19 mm

1,4 kg



	CHF		
T48	334.00	1	024240048
TV47	31.50	1	024000763

T50



○ 96T 2-2,5-3-3,5-4-4,5
 5-6-7-8-10 mm

1,3 kg



	CHF		
T50	221.50	1	024240050
TV50	42.00	1	024000764

T52



○ 96T 2-2,5-3-4-5-6 mm

350 g



	CHF		
T52	108.50	1	024240052
TV52	31.50	1	024000765

T53



○ 96BTP 2,5-3-4-5-6 mm

300 g



	CHF		
T53	97.50	1	024240053
TV52	31.50	1	024000765

T55



○ 97TTX T10-T15-T20
 T25-T27-T30

330 g



	CHF		
T55	125.00	1	024240055
TV55	31.50	1	024000766

T57



96TINOX 2,5-3-4-5-6 mm



350 g



T57	CHF 103.50	1	024240057
TV57	CHF 31.50	1	024249907

T59



- 111E 250 mm
- 920/40 1/2
- 951 2,5-3-4-5-6-8 mm
- 953 4-5-6-8 mm
- 1370 300 - 500 g

4,7 kg



T59	CHF 559.00	1	024240059
TV60	CHF 62.50	1	024000420

T63



952 7-8-10-12-13-14-17-19 mm

3,8 kg



T63	CHF 424.00	1	024240063
TV63	CHF 52.00	1	024000471

T64



952FTX E10-E12-E14
953TX T25-T27-T30-T40-T45

3,8 kg



T64	CHF 520.00	1	024240064
TV63	CHF 52.00	1	024000471

T65



953 3-3,5-4-5-6-7-8-10 mm

2,8 kg



T65	CHF 404.00	1	024240065
TV63	CHF 52.00	1	024000471

T68



951 2,5-3-4-5-6-8 mm

590 g



T68	CHF 181.00	1	024240068
TV68	CHF 31.50	1	024000470

T73



930 6x7-8x9-10x11-12x13-14x15-16x17-18x19-20x22 mm
940/1
940/2

1,3 kg



T73	CHF 270.00	1	024240073
TV73	CHF 31.50	1	024000418

T75



933 7-8-9-10-11-12-13-14-15-16-17-18-19-21-22-24 mm

4,2 kg



T75	CHF 551.00	1	024240075
TV75	CHF 62.50	1	024000422

T76



932 7-8-9-10-11-12-13-14-15-16-17-18-19-21-22-24 mm

4,2 kg



T76	CHF 551.00	1	024240076
TV75	CHF 62.50	1	024000422

T77



933 6-7-8-10-11-12-13-14-17-19 mm

1,4 kg



T77	CHF 275.00	1	024240077
TV77	CHF 31.50	1	024000474

T79



80 8x9-10x11-12x13-14x15-16x17-18x19 mm

1,3 kg



T79	CHF 367.00	1	024240079
TV79	CHF 31.50	1	024000490

T80

29



- 920A 10-11-12-13-14
15-16-17-18-19
20-21-22-23-24
26-27-30-32 mm
- 920ME 5-6-8-10-12 mm
- 920/21 125 mm
- 920/22 255 mm
- 920/25
- 920/42 305 mm
- Ⓢ 920/55

4,1 kg

12"



T80	CHF 515.00	1	024240080
TV80	42.00	1	024000403

T81

29



- 920B 10-11-12-13-14
15-16-17-18-19
20-21-22-23-24
26-27-30-32 mm
- 920ME 5-6-8-10-12 mm
- 920/21 125 mm
- 920/22 255 mm
- 920/25
- 920/42 305 mm
- Ⓢ 920/55

4,1 kg

12"



T81	CHF 515.00	1	024240081
TV80	42.00	1	024000403

T82

29



- 920A 10-11-12-13-14
15-16-17-18-19
20-21-22-23-24
26-27-30-32 mm
- 920ME 5-6-8-10-12 mm
- 920AN/125 125 mm
- 920AN/250 250 mm
- 920/25
- 920/42 305 mm
- Ⓢ 920/55

4,1 kg

12"



T82	CHF 531.00	1	024240082
TV80	42.00	1	024000403

T83

24



- 920A 10-11-12-13-14
15-16-17-18-19
20-21-22-23-24
26-27-30-32 mm
- 920/21 125 mm
- 920/22 255 mm
- 920/25
- 920/42 305 mm
- Ⓢ 920/55

3,6 kg

12"



T83	CHF 398.00	1	024240083
TV83	42.00	1	024000402

T85

81



- 861LP 0,5x3 - 0,6x4,5 - 0,8x5,5 - 1x5,5 - 1,2x6,5 - 1,2x8 - 1,6x8 mm
- 861PE 2 - 2,5 - 3 - 4 - 5 - 6 - 8 - 10 mm
- ⊕ 861PH PH0 - PH1 - PH2 - PH3
- ⊕ 861PZ PZ1 - PZ2 - PZ3
- ⊕ 861TX T6-T7-T8-T9-T10-T15-T20-T25-T27-T30-T40
- ⊕ 861RTX T9-T10-T15-T20-T25-T27-T30-T40
- ⊕ 861TRW 1-2-3-4-5-6 mm
- ⊕ 861TQS 0-1-2-3-4-5-6-8-10 mm
- ⊕ 861SP 4-6-8-10-12 mm
- 851SR 230 mm
- 900 4-4,5-5-5,5-6-7-8-9
10-11-12-13-14 mm
- 900/21 150 mm
- 900/25 41 mm
- 900BG/30 176 mm
- 900/42 115 mm
- Ⓢ 900/55 125 mm
- 194 1/4x5/16

1,0 kg

14"



T85	CHF 434.00	1	024240085
TV85	42.00	1	024000747

T91

25



- 900 4-4,5-5-5,5-6
7-8-9-10-11
12-13-14 mm
- 900ME 2,5-3-4-5-6-8 mm
- 900/20 50 mm
- 900/21 150 mm
- 900/25
- 900BG/30
- 900/42 115 mm
- Ⓢ 900/55

560 g

14"



T91	CHF 278.00	1	024240091
TV90	31.50	1	024000447

T92

22



- 910A 6-7-8-9-10-11-12-13
14-15-16-17-18-19
20-21-22 mm
- 910/21 125 mm
- 910/22 250 mm
- 910/25
- 910/42 210 mm
- Ⓢ 910/55

1,5 kg

38"



T92	CHF 315.00	1	024240092
TV92	31.50	1	024000458

T99

16



- 920INOX-A 10-12-13-14-15-16-17
18-19-21-22-24-27
30-32 mm
- Ⓢ 920/55INOX



2,7 kg

12"



T99	CHF 1.455.00	1	024240099
TV99	31.50	1	024249908

T100

16



- 920A 10-12-13-14-15
16-17-18-19-21
22-24 mm
- 920/21 125 mm
- 920/25
- 920/42 305 mm
- Ⓢ 920/55

2,1 kg

12"



T100	CHF 285.00	1	024240100
TV100	31.50	1	024000495

T101

16



- 920B 10-12-13-14-15
16-17-18-19-21
22-24 mm
- 920/21 125 mm
- 920/25
- 920/42 305 mm
- Ⓢ 920/55

2,1 kg

12"



T101	CHF 285.00	1	024240101
TV100	31.50	1	024000495

T102

16



- 920AS 3/8-7/16-1/2
9/16-5/8-11/16
3/4-13/16-7/8
15/16-1-1.1/16
- 920/21 125 mm
- 920/25
- 920/42 305 mm
- Ⓢ 920/55

2,1 kg

12"



T102	CHF 311.00	1	024240102
TV100	31.50	1	024000495

T103



- 900L 6-7-8-9-10-11-12 mm
- 920AL 13-14-16-17-18-19-21-22-24-27 mm

1,1 kg

14" 12"



T103	CHF 373.00	1	024240103
TV103	31.50	1	024000748

T105



- 928A 22-24-27-30-32-34-36-38-41-46-50 mm

4,9 kg

34"



T105	CHF 372.00	1	024240105
TV105	31.50	1	024000484

T106



- 928/21 200 mm
- 928/22 380 mm
- 928/42 450 mm
- 928/55

4,5 kg

34"



T106	CHF 394.00	1	024240106
TV106	31.50	1	024000485

T111



- 720 10-13-15-17-18-19-21-22-24-27-30-32 mm
- 720LC 17-19-21 mm
- 720/21 125 mm

2,7 kg

12"



T111	CHF 317.00	1	024240111
TV111	31.50	1	024000476

T112



- 861TX ● 1/4-T6+T15
- 866TX ● 5/16-T20+T55
- 895/1 ○ 1/4x□1/4
- 895/6 ○ 5/16x□1/2
- 900FTX □ 1/4-E4+E10
- 920FTX □ 1/2-E12+E24
- 920TX □ 1/2-T55L-T60-T70L

1,3 kg

14" 12"



T112	CHF 377.00	1	024240112
TV112	31.50	1	024000480

T113



- 920PE 5L-6L-7L-8L-10L
- 920TX T40L-T45L T55L-T70L
- 920XZN M6L-M8L-M12L

1,5 kg

12"



T113	CHF 332.00	1	024240113
TV113	31.50	1	024000489

T124



- ◁ 1082GBM 160 mm
- ▬ 1150GBM 180 mm
- 1166GBM 160 mm

640 g



T124	CHF 126.50	1	024240124
TV135	31.50	1	024000762

T135



- ◁ 1082MQ 160 mm
- ▬ 1150MQ 180 mm
- 1166MQ 160 mm

△ 1000 V

750 g



T135	CHF 212.00	1	024240135
TV135	31.50	1	024000762

T136



- 1048MQ 250 mm
- 1777MQ/U

△ 1000 V

700 g



T136	CHF 151.00	1	024240136
TV136	31.50	1	024000438

T121



- 666N/20 40 - 200 Nm

1,4 kg

12"



T121	CHF 368.00	1	024240121
TV121	31.50	1	024000767

T123



- ◁ 1082G 160 mm
- ▬ 1150G 180 mm
- 1166G 160 mm

550 g



T123	CHF 100.00	1	024240123
TV135	31.50	1	024000762

T137



- ◁ 1084BM 160 mm
- ▬ 1150BM 180 mm
- 1166BM 160 mm

750 g



T137	CHF 142.50	1	024240137
TV130	31.50	1	024000451

T138



- 1084 160 mm
- 1150 180 mm
- 1166 160 mm

650 g



	CHF		
T138	118.00	1	024240138
TV130	31.50	1	024000451

T140



- 1032 140x0,9 - 180 mm
- 1034 170 mm
- 1036 140x1,3 - 175 mm
- 1038 175 mm
- 1084 160 mm
- 1128BM

1,1 kg



	CHF		
T140	290.00	1	024240140
TV140	42.00	1	024000405

T144



- 1048N 250 mm
- 1052 240 mm
- 1112 250 mm
- 1150 180 mm

1,8 kg



	CHF		
T144	167.50	1	024240144
TV143	42.00	1	024000409

T145



- 1032 180 mm
- 1034 170 mm
- 1036 175 mm
- 1038 175 mm

640 g



	CHF		
T145	159.50	1	024240145
TV145	31.50	1	024000448

T146



- 1032 140x0,9 mm
- 1032 225 mm
- 1036 140x1,3 mm
- 1036 225 mm

700 g



	CHF		
T146	168.00	1	024240146
TV146	31.50	1	024000449

T151



- 1047 240 mm
- 1057A 240 mm

1,3 kg



	CHF		
T151	144.50	1	024240151
TV150	31.50	1	024000462

T153



- 1048N 250 mm
- 1052 240 mm

1,1 kg



	CHF		
T153	88.00	1	024240153
TV150	31.50	1	024000462

T156



- 1082 160 mm
- 1150 180 mm
- 1048N 250 mm

1 kg



	CHF		
T156	115.50	1	024240156
TV148	31.50	1	024000500

T157



- 1082BM 160 mm
- 1150BM 180 mm
- 1048BM 250 mm

1,1 kg



	CHF		
T157	158.00	1	024240157
TV148	31.50	1	024000500

T160



- 1290 3x75
- 3x100
- 4x100
- 4x150
- 5,5x100
- 5,5x150
- 6,5x150
- 8x150
- 10x200 mm
- 1290N 4x30
- 6,5x30 mm

1,3 kg



	CHF		
T160	170.50	1	024240160
TV160	42.00	1	024000706

T161



- 1292 PH0x60
- PH0x100
- PH1x80
- PH1x120
- PH2x100
- PH2x150
- PH3x150 mm
- 1292N PH1x30
- PH2x30 mm

1 kg



	CHF		
T161	134.00	1	024240161
TV161	42.00	1	024000707

T164



- 952 8-10-13-17-19mm
- 959 16mm (5/8") - 20,8mm (13/16")
- 1260 3x75-4x100-5,5x100-6,5x150-10x200mm
- 1262 PH0x60-PH1x80-PH2x100-PH3x150mm

5 kg



	CHF		
T164	590.00	1	024240164
TV61	62.50	1	024000721

T167



- 1260 3x75
3x100
4x100
4x150
5.5x100
5.5x150
6.5x150
8x150
10x200 mm
- 1260N 4x30
6.5x30 mm

1,3 kg



	CHF	
T167	140.50	1 024240167
TV160	42.00	1 024000706

T168



- 1262 PH0x60
PH0x100
PH1x80
PH1x120
PH2x100
PH2x150
PH3x150 mm
- 1262N PH1x30
PH2x30 mm

1 kg



	CHF	
T168	111.50	1 024240168
TV161	42.00	1 024000707

T170



- 1290 2.5x50
3x75
3.5x100
4x125
5.5x100
5.5x150
6.5x150 mm

450 g



	CHF	
T170	92.50	1 024240170
TV170	31.50	1 024000741

T171



- 1290 8x150
8x200
10x200 mm
- 1290N 4x30
6.5x30 mm

750 g



	CHF	
T171	102.50	1 024240171
TV171	31.50	1 024000742

T172



Betamax

- 1292 PH0x60
PH0x100
PH1x80
PH1x120
PH2x100
PH2x150 mm

450 g



	CHF	
T172	84.50	1 024240172
TV172	31.50	1 024000743

T173



Betamax

- 1292 PH3x150
PH4x200 mm
- 1292N PH1x30
PH2x30 mm

560 g



	CHF	
T173	82.50	1 024240173
TV173	31.50	1 024000744

T175



Betamax

- 1297TX T6-T7-T8-T9
T10-T15-T20

410 g



	CHF	
T175	131.50	1 024240175
TV175	31.50	1 024000760

T176



Betamax

- 1297TX T25-T27-T30
T40-T45

640 g



	CHF	
T176	121.50	1 024240176
TV176	31.50	1 024000761

T177



Betamax

- 1298RTX T9-T10-T15
T20-T25-T27
T30-T40

680 g



	CHF	
T177	183.50	1 024240177
TV177	31.50	1 024000759

T180



Betamax

- 1290 3x75
4x100
5.5x150
6.5x150 mm
- 1292 PH0x60
PH1x80
PH2x100 mm

480 g



	CHF	
T180	96.00	1 024240180
TV180	31.50	1 024000701

T183



Betamax

- 1292L PH1x400-PH2x400 mm
- 1294L 3x300-4x400-5x400 mm

580 g



	CHF	
T183	130.00	1 024240183
TV183	31.50	1 024000497

T198



- 1260 3x75
4x100
5.5x150
6.5x150 mm
- 1269PZ P20 - P21 - P22

490 g



	CHF	
T198	83.00	1 024240198
TV180	31.50	1 024000701

T199



- 1260 2,5x50
3x75
3,5x100
4x125
5,5x100
5,5x150
6,5x150 mm

490 g



	CHF		
T199	75.00	1	024240199
TV170	31.50	1	024000741

T201



- 1260 8x200
10x150
10x200 mm
- 1260N 4x30
6,5x30 mm

680 g



	CHF		
T201	82.00	1	024240201
TV171	31.50	1	024000742

T202



- ⊕ 1262 PH0x60
PH0x100
PH1x80
PH1x120
PH2x100
PH2x150 mm

490 g



	CHF		
T202	69.50	1	024240202
TV172	31.50	1	024000743

T204



- ⊕ 1262 PH3x150
PH4x200 mm
- ⊕ 1262N PH1x30
PH2x30 mm

610 g



	CHF		
T204	68.00	1	024240204
TV173	31.50	1	024000744

T205



- ⊕ 1267TX T6-T7-T8-T9
T10-T15-T20

460 g



	CHF		
T205	98.00	1	024240205
TV175	31.50	1	024000760

T206



- ⊕ 1267TX T25-T27-T30
T40-T45

710 g



	CHF		
T206	101.50	1	024240206
TV176	31.50	1	024000761

T207



- ⊕ 1268RTX T9-T10-T15
T20-T25-T27-T30

760 g



	CHF		
T207	121.00	1	024240207
TV207	31.50	1	024000758

T208



- 1260 3x75
4x100
5,5x150
6,5x150 mm
- ⊕ 1262 PH0x60
PH1x80
PH2x100 mm

530 g



	CHF		
T208	79.50	1	024240208
TV180	31.50	1	024000701

T209



- ⊕ 1262L PH1x400-PH2x400 mm
- 1264L 3x300-4x400-5x400 mm

580 g



	CHF		
T209	99.00	1	024240209
TV183	31.50	1	024000497

T211



- 1201E 2,5x50
3x75
3,5x100
4x125
5,5x100
5,5x150
6,5x150 mm

490 g



	CHF		
T211	54.00	1	024240211
TV170	31.50	1	024000741

T213



- ⊕ 1202E PH0x60
PH1x80
PH1x120
PH2x100
PH2x150
PH3x150 mm

490 g



	CHF		
T213	58.00	1	024240213
TV212	31.50	1	024000440

T216



- ⊕ 1207E/TX T6-T7-T8-T9
T10-T15-T20

410 g



	CHF		
T216	74.50	1	024240216
TV175	31.50	1	024000760

T221



- 1201E 3x75
4x100
5.5x150
6.5x150 mm
- ⊕ 1202E PH0x60
PH1x80
PH2x100 mm

530 g



	CHF	
T221	56.50	1 024240221
TV180	31.50	1 024000701

T226

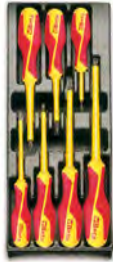

- 1274MQ 3x100
4x100
5.5x125
6.5x150 mm
- ⊕ 1272MQ PH0x60
PH1x80
PH2x100 mm

⚡ 1000 V

460 g



	CHF	
T226	123.50	1 024240226
TV180	31.50	1 024000701

T227



- 944BX 5-6-7-8-10-13 mm

490 g



	CHF	
T227	174.00	1 024240227
TV227	31.50	1 024000705

T228



- 1290INOX 3x75 - 4x100 -
5.5x150 - 6.5x150 mm
- ⊕ 1292INOX PH0x60 - PH1x80 -
PH2x100 mm



480 g



	CHF	
T228	109.50	1 024240228
TV180	31.50	1 024000701

T231



- 1370 400 g
- 1390 Ø 35 mm
- ▲ 1719BMA/T 200 mm
- 1719BMA/P 200 mm
- 1719BMA/M 200 mm

1,7 kg



	CHF	
T231	150.50	1 024240231
TV230	42.00	1 024000411

T233



- 35 100-200 mm
- 1370F 32 mm
- 1390 Ø 35 mm

1,3 kg



	CHF	
T233	137.00	1 024240233
TV232	31.50	1 024000452

T234



- 35 100-200 mm
- 1370 300 g
- 1390 Ø 35 mm

1,3 kg



	CHF	
T234	123.50	1 024240234
TV232	31.50	1 024000452

T236



- 1719BMA/Q 200 mm
- ▲ 1719BMA/T 200 mm
- 1719BMA/P 200 mm
- 1719BMA/M 200 mm
- 1719BMA/R 200 mm

870 g



	CHF	
T236	122.50	1 024240236
TV235	31.50	1 024000453

T239



- 31BM Ø 2-3-4-5-6-8 mm
- 32 Ø 4 mm

850 g



	CHF	
T239	162.00	1 024240239
TV239	31.50	1 024000439

T241



- 1500N/1
- 1500N/3
- 1516/1

4,2 kg



	CHF	
T241	378.00	1 024240241
TV241	42.00	1 024000414

T250

Automotive



- 34 150 mm
- 83/S3 11x13-14x17
19x22 mm
- 1458 175 mm
- 1491
- 1603
- 1708/13 0,05+1 mm

1430 g



	CHF	
T250	332.00	1 024240250
TV250	42.00	1 024000408

T256

Automotive



- 956E 16 mm (5/8) - 20,8 mm (13/16)
- 956L 16 mm (5/8) - 20,8 mm (13/16)
- 959 16 mm (5/8) - 20,8 mm (13/16)
- 1164 200 mm
- 1708/20 0,05+1 mm

3,2 kg



	CHF	
T256	528.00	1 024240256
TV255	52.00	1 024000467

T259



- 96BP 2,5-3-4-5
6-8-10 mm
- 96N 12 mm
- 860MIX/A31
-
- +
- +
- +
- 895/1

950 g



	CHF		
T259	189.50	1	024240259
TV263	31.50	1	024000492

T264



- 1491 Ø 65+110 mm
- 1494 10 mm
- 1494E 8-9-10-11-12-14-17 mm
- 1494Q 8-9,5-12-13 mm
- △ 1494T 9,5
- 1494XZLN 16
- 1496C 8x 10 mm

2,1 kg



	CHF		
T264	285.00	1	024240264
TV264	31.50	1	024000466

T270



- 430 M3 - 4 - 5 - 6 - 7 - 8 - 9
10 - 12 - 14 - 16 - 18 - 20
- 433 M6x0,75 - M8x1 - M10x1,25
M12x1,5 - M14x1,5
M16x1,5 - M18x1,5
- 440 M3 - 4 - 5 - 6 - 7 - 8 - 9
- 440A M10 - 12 - 14 - 16 - 18 - 20
- 441 M6x0,75 - M8x1,0
- 441A M10x1,25 - M12x1,5
M14x1,5 - M16x1,5
M18x1,5

4,3 kg



	CHF		
T270	665.00	1	024240270
TV270	42.00	1	024000481

T273



- 435/1,5 M3+M12
- 435/3 M5+M21
- 436/1 □ 2,0+5,0 mm
(M3+M8)
- 436/2 □ 4,6+8 mm
(M5+M12)
- 444/1 Ø 25,4 mm
- 444/2 Ø 38,1 mm
- 1707 W 62+4x1"

2,1 kg



	CHF		
T273	299.00	1	024240273
TV272	42.00	1	024000482

T281



- 1741B 250 mm
- 1741RV2,9K 2,9x6 mm (100)
- 1741RV3,2K 3,2x8 mm (100)
- 1741RV3,8K 3,8x10 mm (100)
- 1741RV4K 4x12 mm (100)

1,4 kg



	CHF		
T281	93.50	1	024240281
TV280	31.50	1	024000478

T285



- 1112 250 mm
- 1128BM -
- 1726 400 mm
- 1728BM (5 pezzi)
- 1753 200 cc

1,5 kg



	CHF		
T285	153.00	1	024240285
TV285	52.00	1	024000487

T284



- 1128BMX
- 1130BMX
- 1719BMA...Q 200 mm
- ▲ 1719BMA...T 200 mm
- 1719BMA...P 200 mm
- ▶ 1719BMA...M 200 mm
- 1719BMA...R 200 mm
- 1726BM 400 mm
- 1728BM
- 1771BM 170 mm
- 1778V18 185 mm

3,3 kg



	CHF		
T284	324.00	1	024240284
TV286	62.50	1	024249904

T289



- 1692 5 m
- 1725CR -
- 1755 30 cc
- 1771 -

500 g



	CHF		
T289	61.50	1	024240289
TV290	31.50	1	024000455

T291



- 1479RB/1
- 1479RB/2
- 1479RB/3

600 g



	CHF		
T291	129.50	1	024240291
TV291	31.50	1	024000472



T297



1651DGTB
1682
1691BM

490 g



	CHF		
T297	180.00	1	024240297
TV296	31.50	1	024000749

VP1 - VP2

Bacs de rangement compartimentés en matière plastique pour tous les modèles de coffres: RSC22, RSC23, RSC23C

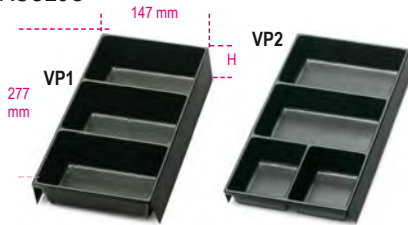

	H mm	CHF		
VP1	50	18.10	1	088880351
VP2	35	18.10	1	088880352

VP3 - VP4

Bacs de rangement compartimentés en matière plastique pour tous les modèles de servants et coffres et pour les chariots

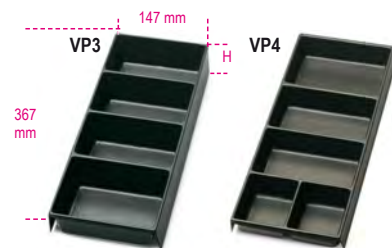

	H mm	CHF		
VP3	50	19.00	1	088880353
VP4	35	19.00	1	088880354

VP5

Bacs de rangement



	CHF		
VP5	21.50	1	088880355



VP6

Bacs de rangement

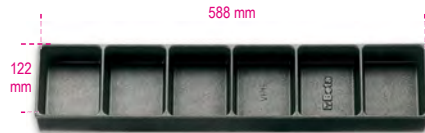

	CHF		
VP6	21.80	1	088880359

VP-3SC

Bacs de rangement compartimentés en matière plastique pour C38 +C04TSS-7

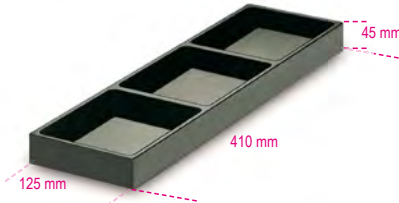

	H mm	CHF		
VP-3SC	45	22.90	1	088880356

VP-LS

Bacs de rangement compartimentés en matière plastique pour C38 +C04TSS-7



	H mm	CHF		
VP-LS	45	15.60	1	088880357

VP-LD

Bacs de rangement compartimentés en matière plastique pour C38



	H mm	CHF		
VP-LD	45	15.00	1	088880358

8889P1

Séparateurs parallèles pour RSC22, RSC23, RSC23C et C27S
Tiroir 588x277 mm



	h mm	CHF		
8889P1/5	50 mm	60.00	1	088890005
8889P1/7	70 mm	62.00	1	088890007

8889C1

Séparateurs croisés pour RSC22, RSC23, RSC232C et C27S
Tiroir 588x277 mm

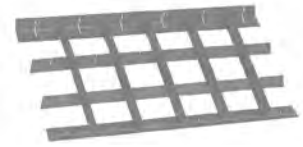

	h mm	CHF		
8889C1/5	50 mm	80.50	1	088890015
8889C1/7	70 mm	82.50	1	088890017

8889P2

Séparateurs parallèles pour tiroir standard 588x367 mm



	h mm	CHF		
8889P2/7	70 mm	72.50	1	088890107

8889C2

Séparateurs croisés pour tiroir standard 588x367 mm

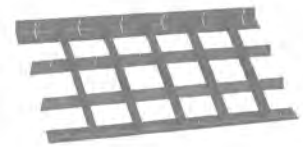

	h mm	CHF		
8889C2	70 mm	93.00	1	088890117

8889P3

Séparateurs parallèles pour RSC24AXL

Tiroir 882x367 mm



	h mm	CHF		
8889P3	70 mm	116.00	1	088890207

8889C3

Séparateurs croisés pour RSC24AXL

Pour tiroir 882x367 mm



	h mm	CHF		
8889C3	70 mm	142.00	1	088890217

8889P4

Séparateurs parallèles pour chariot C41

Tiroir 418x205 mm



	h	CHF		
8889P4	70 mm	49.00	1	088890307

8889I4

Séparateurs croisés pour chariot C41

Tiroir 418x205 mm



	h	CHF		
8889C4	70 mm	59.00	1	088890317

8889PS

Séparateurs parallèles pour C38 - C45PRO M4/M5/M7/M8

Tiroir côté gauche 570x410 mm



	h	CHF		
8889PS/7	70 mm	86.00	1	088890407

8889CS

Séparateurs croisés pour C38 - C45PRO M4/M5/M7/M8

Tiroir côté gauche 570x410 mm



	h	CHF		
8889CS/7	70 mm	104.50	1	088890417

8889PD

Séparateurs parallèles pour C38

Tiroir côté droit 313x410 mm



	h	CHF		
8889PD/7	70 mm	46.00	1	088890427

8889CD

Séparateurs croisés pour C38

Tiroir côté droit 313x410 mm



	h	CHF		
8889CD/7	70 mm	63.00	1	088890437

8889C6

Séparateurs croisés pour C35

Tiroir 600x447 mm



	h	CHF		
8889C6/7,5	75 mm	44.50	1	088890475
8889C6/10	100 mm	44.00	1	088890480
8889C6/15	150 mm	55.00	1	088890485
8889C6/20	200 mm	85.50	1	088890490

SB

Rail porte-douilles



	L mm	CHF		
SB1	210	4.60	10	088880201
SB2	280	5.10	10	088880202
SB3	360	5.40	10	088880203

PM 1/2-Q5

Rail magnétique porte douilles

12"



	CHF		
PM 1/2-Q5	56.00	1	088880233

MB

Clips porte-douilles pour rail SB



		CHF		
MB0	1/4	1.37	50	088880210
MB1	3/8	1.37	50	088880211
MB2	1/2	1.37	50	088880212

KIT/GPS

Jeu de crochets 40 mm avec vis VE1

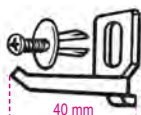

	CHF		
KIT/GPS	2.65	50	088880119

VE1

Vis à expansion



	CHF		
VE1	0.93	20	088880120

GM

Crochet à ressort avec vis à expansion VE1



Ø mm	CHF		
6,5	8.45	5	088880250
9,5	8.80	5	088880251
13	8.80	5	088880252
16	10.40	5	088880253
19	10.80	5	088880254
25	10.20	5	088880255

S55/8

Support pour 8 clés à fourches, en tôle

• Fourni avec 3 vis à expansion VE1

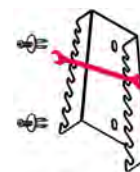

	CHF		
S55/8 55/S8 55AS/8 55MP/S8	29.00	1	088880420

S55/12

Support pour 12 clés à fourches, en tôle

• Fourni avec 3 vis à expansion VE1

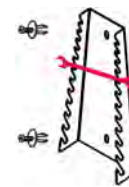

	CHF		
S55/12 55/S12 55/S12X 55AS/12 55MP/S12	35.50	1	088880421

ST2P

Poche porte-pinces, en tôle

• Fourni avec 3 vis à expansion VE1

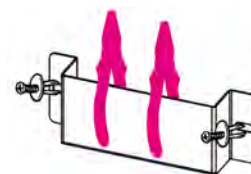

	CHF		
ST2P	31.50	1	088880422

TSPP

Poche porte-outils, en plastique

• Fourni avec 3 vis à expansion VE1



	CHF		
TSPP	7.15	1	088880402

S952/10

Support pour 10 clés à béquille, en tôle

- Fourni avec 4 vis à expansion VE1

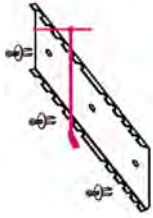

S952/10 CHF 38.00 1 088880423

S1719BM

Support pour 5 limes, en tôle

- Fourni avec 3 vis à expansion VE1



S1719BM CHF 21.80 1 088880404
1719BMA: Q-T-P-M-R
1719BMD: Q-T-P-M-R
1719BMX: Q-T-P-M-R

SGN

Support pour 2 mini tournevis, en tôle

- Fourni avec 3 vis à expansion VE1

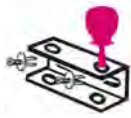

SGN CHF 11.00 1 088880405
1290N-1292N-1299N/PZ
1260N-1262N-1269N/PZ
1201EN-1202EN-1209EN/PZ

CB/2

Plateau thermoformé rigide vide pour douilles et accessoires de 1/2"

- Uniquement pour C54S

12"



CB/2 CHF 33.50 1 088880411
920A/920B
10+24+26-27
28-30-32 mm
920/21-920/22-920/25-
920/42-920/55

S42/17

Support pour 17 clés mixtes, en tôle

- Fourni avec 3 vis à expansion VE1



S42/17 CHF 37.00 1 088880428
42/S17
42MP/S17
42/S17X
42AS/17
142/S17

S951/6

Support pour 6 clés mâles en T, en tôle

- Fourni avec 3 vis à expansion VE1

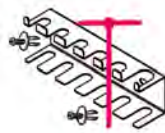

S951/6 CHF 24.70 1 088880429
951/S6
951AS/S6X
951TX/S6

SPG11 - S1203/8

Support pour tournevis, en tôle

- Fourni avec 3 vis à expansion VE1



SPG11 CHF 25.50 1 088880910
n.8 Ø = 7 mm
n.2 Ø = 10 mm
n.1 Ø = 12 mm
S1203/8 27.00 1 088880430
1203E/S8
1263/D8
1293/S8

S96T/8

Support pour 8 clés mâles 6 pans à poignée en T haute performance, en tôle

- Fourni avec 3 vis à expansion VE1



S96T/8 CHF 27.00 1 088880431
96T/AS8
96T/S8
97TTX/S8

96T/SPV

Support pour 11 clés mâles 6 pans à poignée en T haute performance, en tôle

- Fourni avec 3 vis à expansion VE1

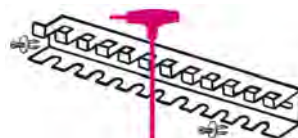

96T/SPV CHF 44.50 1 000960958
96T/S11
97TTX/S11

Beta



Beta CHEMICALS

Serrer un boulon ne suffit pas toujours pour obtenir un serrage sûr. Il faut le nettoyer, le lubrifier, le sceller.

La famille se compose d'agents scellants anaérobies, d'adhésifs cyanoacryliques et d'aérosols pour la maintenance, le nettoyage et lubrification des composants mécaniques.

Produits en milieu anaérobie

Les produits en milieu anaérobie garantissent le remplissage complet des petites irrégularités superficielles du métal, de sorte à garantir la distribution des sollicitations mécaniques sur toute la surface de connexion. Ils se consolident en absence totale d'oxygène et scellent complètement le raccord ou le taraudage pour l'eau, le gaz, les huiles, les carburants et les fluides industriels. Ils sont disponibles en trois classes de résistances : haute (H), moyenne (M) et basse (L) et en différentes tailles de packaging pour toutes les exigences.

Mastic silicone

- Assure une étanchéité élastique permanente.
- Remplace les joints préformés.
- L'applicateur pratique permet de poser facilement, précisément et uniformément le produit.
- Polymérise par réaction avec l'humidité de l'air et forme un joint élastique et durable.

Colle instantanée

Adhésif à l'éthyle cyanoacrylate pour joints structurels de différents matériaux.

Aérosol

Vaste gamme de produits en aérosol conçus pour débloquer, graisser, lubrifier, nettoyer, galvaniser et hygiéniser.

Liquides

Créés pour éliminer les incrustations et la rouille présentes sur les pièces mécaniques et les objets en métal. Idéals pour l'emploi dans les cuves de lavage à ultrasons 1895.



ATTENTION

Pays où les produits de la gamme Beta Chemicals peuvent être distribués : Autriche, Andorre, Belgique, Émirats arabes unis, France, Italie, Nouvelle-Calédonie, Pays-Bas, Pologne, Portugal, Principauté de Monaco, Royaume-Uni, République tchèque, République d'Irlande, République dominicaine, République Populaire de Chine, Réunion, Saint-Marin, Slovaquie, Slovénie, Espagne, Suisse, Hongrie

9803H

frein filet-Forte résistance

Idéal pour le blocage permanent.
Idéal pour tous les pièces qui ne doivent pas être démontées ou pour l'application sur les surfaces métalliques passivées telles que le cuivre, l'aluminium, l'acier inox etc.
Ne permet pas le démontage avec outils manuels.



Température (°C)	-50/+150
Jeu diamétral (mm)	0,25
Vitesse de réaction blocage manuel (minutes)	10/15
Durcissement fonctionnel (heures)	3-6
Viscosité (mPa.s) 25°C	800/1200
Couple de dévissage INITIAL ISO-10964	35-45 Nm
Couple de dévissage RESIDUEL ISO-10964	30-40 Nm

ml		CHF		
20	Flacon	14.10	12	098030002
50	Flacon	21.60	4	098030005
250	Flacon	54.50	4	098030025
20	Flacon		12	098032002
50	Flacon		4	098032005
250	Flacon		4	098032025

9802M

frein filet-Moyenne résistance

Idéal pour fixer et bloquer les parties soumises à maintenance périodique.
Permet le démontage avec des outils manuels.



Température (°C)	-50/+150
Jeu diamétral (mm)	0,15
Vitesse de réaction blocage manuel (minutes)	10/15
Durcissement fonctionnel (heures)	3-6
Viscosité (mPa.s) 25°C	500/800
Couple de dévissage INITIAL ISO-10964	22-30 Nm
Couple de dévissage RESIDUEL ISO-10964	20-25 Nm

ml		CHF		
20	Flacon	14.10	12	098020002
50	Flacon	21.60	4	098020005
250	Flacon	54.50	4	098020025
20	Flacon		12	098022002
50	Flacon		4	098022005
250	Flacon		4	098022025

9801L

frein filet-Basse résistance

Idéal pour fixer les détails en alliages légers qui pourraient s'endommager en phase de démontage ou pour les vis de réglage.
Démontage des pièces facilité.



Température (°C)	-50/+150
Jeu diamétral (mm)	0,10
Vitesse de réaction blocage manuel (minutes)	10/15
Durcissement fonctionnel (heures)	3-6
Viscosité (mPa.s) 25°C	500/800
Couple de dévissage INITIAL ISO-10964	6-10 Nm
Couple de dévissage RESIDUEL ISO-10964	4-8 Nm

ml		CHF		
20	Flacon	14.10	12	098010002
50	Flacon	21.60	4	098010005
250	Flacon	54.50	4	098010025
20	Flacon		12	098012002
50	Flacon		4	098012005
250	Flacon		4	098012025

9813H

scellant à filet-Forte résistance

Idéale pour scellage des raccords filetés qui ne doivent pas être démontés.
Pour l'application sur les surfaces métalliques passivées telles que le cuivre, l'aluminium, l'acier inox etc.
Ne permet pas le démontage avec outils manuels.



Température (°C)	-50/+200
Jeu diamétral (mm)	0,15
Vitesse de réaction blocage manuel (minutes)	10/15
Durcissement fonctionnel (heures)	3-6
Viscosité (mPa.s) 25°C	40.000/80.000
Couple de dévissage INITIAL ISO-10964	35-45 Nm
Couple de dévissage RESIDUEL ISO-10964	25-35 Nm

ml		CHF		
20	Flacon	12.70	12	098130002
50	Flacon à soufflet	22.20	6	098130305
50	Tube	20.70	4	098130505
250	Tube	51.50	4	098130525
20	Flacon		12	098132002
50	Flacon à soufflet		6	098132305
50	Tube		4	098132505
250	Tube		4	098132525

9812M

scellant à filet-Moyenne résistance

Idéale pour scellage des raccords filetés et parties soumises à maintenance périodique.
Permet le démontage avec des outils manuels.



Température (°C)	-50/+150
Jeu diamétral (mm)	0,35
Vitesse de réaction blocage manuel (minutes)	12/18
Durcissement fonctionnel (heures)	3-6
Viscosité (mPa.s) 25°C	20.000/40.000
Couple de dévissage INITIAL ISO-10964	27-35 Nm
Couple de dévissage RESIDUEL ISO-10964	20-30 Nm

ml		CHF		
20	Flacon	12.70	12	098120002
50	Flacon à soufflet	22.20	6	098120305
50	Tube	20.70	4	098120505
250	Tube	51.50	4	098120525
20	Flacon		12	098122002
50	Flacon à soufflet		6	098122305
50	Tube		4	098122505
250	Tube		4	098122525

9811L

scellant à filet-Basse résistance

Idéal pour sceller les joints de petite taille ou à pas fin.
Démontage des pièces facilité



Température (°C)	-50/+150
Jeu diamétral (mm)	0,20
Vitesse de réaction blocage manuel (minutes)	10/15
Durcissement fonctionnel (heures)	3-6
Viscosité (mPa.s) 25°C	10.000/20.000
Couple de dévissage INITIAL ISO-10964	6-10 Nm
Couple de dévissage RESIDUEL ISO-10964	4-8 Nm

ml		CHF		
20	Flacon	12.70	12	098110002
50	Flacon à soufflet	22.20	6	098110305
50	Tube	20.70	4	098110505
250	Tube	51.50	4	098110525
20	Flacon		12	098112002
50	Flacon à soufflet		6	098112305
50	Tube		4	098112505
250	Tube		4	098112525

9823H

joint liquide-Forte résistance

Idéal pour sceller les surfaces de manière permanente.
Idéale également pour reconstruire les sièges de roulements
ou les pièces usées.
Ne permet pas le démontage avec outils manuels.



Température (°C)	-50/+150
Jeu diamétral (mm)	0,35
Vitesse de réaction blocage manuel (minutes)	10/16
Durcissement fonctionnel (heures)	3-6
Viscosité (mPa.s) 25°C	100.000/200.000
Couple de dévissage INITIAL ISO-10964	35-45 Nm
Couple de dévissage RESIDUEL ISO-10964	20-30 Nm

ml		CHF		
20	Flacon	12.70	12	098230002
50	Flacon à soufflet	22.20	6	098230305
50	Tube	20.70	4	098230505
250	Tube	51.50	4	098230525
20	Flacon		12	098232002
50	Flacon à soufflet		6	098232305
50	Tube		4	098232505
250	Tube		4	098232525

9822M

joint liquide-Moyenne résistance

Idéal pour sceller les parties soumises à maintenance
périodique.
Permet le démontage avec des outils manuels.



Température (°C)	-50/+150
Jeu diamétral (mm)	0,35
Vitesse de réaction blocage manuel (minutes)	10/15
Durcissement fonctionnel (heures)	3-6
Viscosité (mPa.s) 25°C	40.000/70.000
Couple de dévissage INITIAL ISO-10964	25-35 Nm
Couple de dévissage RESIDUEL ISO-10964	20-30 Nm

ml		CHF		
20	Flacon	12.70	12	098220002
50	Flacon à soufflet	22.20	6	098220305
50	Tube	20.70	4	098220505
250	Tube	51.50	4	098220525
20	Flacon		12	098222002
50	Flacon à soufflet		6	098222305
50	Tube		4	098222505
250	Tube		4	098222525

9821L

joint liquide-Basse résistance

Idéal pour sceller les surfaces des parties soumises à
maintenance périodique.
Tolère la légère contamination d'huiles.
Protège les filetages de corrosion et grippages de corrosion.
Démontage des pièces facilité.



Température (°C)	-50/+150
Jeu diamétral (mm)	0,35
Vitesse de réaction blocage manuel (minutes)	20/30
Durcissement fonctionnel (heures)	3-6
Viscosité (mPa.s) 25°C	60.000/90.000
Couple de dévissage INITIAL ISO-10964	7-11 Nm
Couple de dévissage RESIDUEL ISO-10964	4-9 Nm

ml		CHF		
20	Flacon	12.70	12	098210002
50	Flacon à soufflet	22.20	6	098210305
50	Tube	20.70	4	098210505
250	Tube	51.50	4	098210525
20	Flacon		12	098212002
50	Flacon à soufflet		6	098212305
50	Tube		4	098212505
250	Tube		4	098212525

9833H

bloquant-Forte résistance

Idéal pour fixer tous les pièces qui ne doivent pas être
démontées.
Adapté pour bloquer les dispositifs déjà installés où le
démontage est difficile.
Ne permet pas le démontage avec outils manuels.



Température (°C)	-50/+180
Jeu diamétral (mm)	0,15
Vitesse de réaction blocage manuel (minutes)	10/15
Durcissement fonctionnel (heures)	3-6
Viscosité (mPa.s) 25°C	400/700
Couple de dévissage INITIAL ISO-10964	35-45 Nm
Couple de dévissage RESIDUEL ISO-10964	30-40 Nm

ml		CHF		
20	Flacon	13.40	12	098330002
50	Flacon	20.70	4	098330005
250	Flacon	53.50	4	098330025
20	Flacon		12	098332002
50	Flacon		4	098332005
250	Flacon		4	098332025

9832M

bloquant-Moyenne résistance

Idéal pour fixer les parties soumises à maintenance
périodique.
Permet le démontage avec des outils manuels.



Température (°C)	-50/+180
Jeu diamétral (mm)	0,25
Vitesse de réaction blocage manuel (minutes)	12/20
Durcissement fonctionnel (heures)	3-6
Viscosité (mPa.s) 25°C	2000/4000
Couple de dévissage INITIAL ISO-10964	25-35 Nm
Couple de dévissage RESIDUEL ISO-10964	18-28 Nm

ml		CHF		
20	Flacon	13.40	12	098320002
50	Flacon	20.70	4	098320005
250	Flacon	53.50	4	098320025
20	Flacon		12	098322002
50	Flacon		4	098322005
250	Flacon		4	098322025

9831L

bloquant-Basse résistance

Idéal pour fixer les pièces de petite taille soumises à
maintenance périodique et de petites dimensions.
Démontage des pièces facilité.



Température (°C)	-50/+150
Jeu diamétral (mm)	0,10
Vitesse de réaction blocage manuel (minutes)	10/15
Durcissement fonctionnel (heures)	3-6
Viscosité (mPa.s) 25°C	500/800
Couple de dévissage INITIAL ISO-10964	6-10 Nm
Couple de dévissage RESIDUEL ISO-10964	4-8 Nm

ml		CHF		
20	Flacon	13.40	12	098310002
50	Flacon	20.70	4	098310005
250	Flacon	53.50	4	098310025
20	Flacon		12	098312002
50	Flacon		4	098312005
250	Flacon		4	098312025

Beta

9841N

Mastic silicone noir, résistant aux hautes températures, avec distributeur pratique

Résiste à des températures jusqu'à 240 ° C
Permet une étanchéité élastique permanente. Remplace les joints préformés.
Le distributeur permet un étalement facile, précis et uniforme du produit.
Polymérise en réagissant avec l'humidité atmosphérique et forme un joint élastique et durable.
Idéal pour les carter d'huile, les pompes à huile, les carter, les boîtes de vitesses, les pièces de moteur qui ne sont pas soumises à une pression élevée et les applications qui nécessitent une résistance à des températures élevées.
Adhère aux surfaces non poreuses, y compris le verre, le bois revêtu, la céramique et l'émail. Ne convient pas aux revêtements PE, PP, PC, PMMA, PTFE, plastiques souples, néoprène et bitumineux.
Ne peut pas être peint.



ml	CHF		
200	33.50	12	098410120
200		12	098412120

9841R

Mastic silicone rouge, résistant aux hautes températures, avec distributeur pratique

Résiste à des températures jusqu'à 300 ° C.
Permet une étanchéité élastique permanente. Remplace les joints préformés.
Le distributeur permet un étalement facile, précis et uniforme du produit.
Polymérise en réagissant avec l'humidité atmosphérique et forme un joint élastique et durable.
Idéal pour les portes, les plaques, les systèmes de chauffage, les sorties, les thermostats, les pompes, les tuyaux de chauffage, les pièces de moteur qui ne sont pas soumis à une pression élevée et les applications qui nécessitent une résistance à des températures élevées. Adhère aux supports non poreux, y compris le verre, le bois revêtu, la céramique et l'émail. Ne convient pas aux supports PE, PP, PC, PMMA, PTFE, plastiques souples, néoprène et bitumineux.
Ne peut pas être peint.



ml	CHF		
200	31.50	12	098410020
200		12	098412020

9851

colle instantanée pour joints structuraux

à base de cyanoacrylate d'éthyle pour l'adhérence d'une large gamme de matériaux, y compris le métal, les plastiques, cuir, bois et plusieurs autres types de substrats, qu'ils soient combinés entre eux ou séparés; se lie rapidement.



Temperature (°C)	
-55/+82	
Viscosité (mPa.s) 25 °C	80-120

g		CHF		
5	Tube	6.90	24	098510500
20	Flacon	13.40	12	098510002
50	Flacon	26.00	10	098510005
5	Tube		24	098512500
20	Flacon		12	098512002
50	Flacon		10	098512005

9710 - LUBRIBETA universal

débloquant multiusage 7 fonctions en 1 seul produit

1. Débloquant;
 2. Lubrifiant;
 3. Détergent, dégraissant;
 4. Protecteur antirouille;
 5. Désoxydant pour contacts électriques;
 6. Hydrofuge;
 7. Antigél.
- Ne contient pas de silicone.



ml	CHF		
400	11.20	12	097100040
400		12	097101040
400		12	097102040



9712 - Ultra Sblock

débloquant, super-pénétrant

Débloquant, désoxydant et hydrofuge. Idéal pour dissoudre la rouille sur les écrous, les boulons, les vis et les engrenages.



ml	CHF		
400	7.75	12	097120040
400		12	097121040
400		12	097122040

9720 - Multi Grease

graisse multiusage

Particulièrement indiqué pour la lubrification de chaînes, engrenages et pièces métalliques en mouvement. Résiste aux frottements et aux agents atmosphériques. Hautement adhésif. Ne coule pas.



ml	CHF		
400	9.10	12	097200040
400		12	097201040
400		12	097202040

9722 - Lithium Grease

graisse blanche au lithium

À base de graisses savonneuses de lithium, titane et oxydes de zinc. Idéal pour engrenages, roulements et raccords. Spécifique pour applications marines. Fortement résistant à l'eau, à l'air salin, aux agents atmosphériques et à hautes températures (jusqu'à 150 °C). Ne coule pas.



ml	CHF		
400	10.50	12	097220040
400		12	097221040
400		12	097222040

9724 - PTFE Grease

graisse à base de P.T.F.E.

Particulièrement indiqué pour la lubrification des chaînes industrielles et les mouvements mécaniques à fortes pressions et rotations non élevées.
Adapté aux applications sur plastique et caoutchouc.
Complètement incolore. Hydrofuge et résistant à l'oxydation.



ml	CHF		
400	12.00	12	097240040
400		12	097241040
400		12	097242040

9726 - Copper Grease

graisse au cuivre

Pour la lubrification de raccords, boulons, engrenages, arbres moteur et autres pièces métalliques sujettes à hautes températures (jusqu'à 1.000 °C).
Protecteur, anti-usure.
Prévient l'oxydation. Ne coule pas.



ml	CHF		
400	14.10	12	097260040
400		12	097261040
400		12	097262040

9729 - Silic Spray

silicone spray

Adapté à la lubrification des pièces en plastiques, caoutchouc et métaux.
Protège de la corrosion. Antiadhérent.
Antistatique. Hydrofuge.
Polissant pour bois, plastique et caoutchouc.
Ne contient pas de solvants.



ml	CHF		
400	8.20	12	097290040
400		12	097291040
400		12	097292040

9738 - Cutting Oil

Huile de coupe

À haut pouvoir lubrifiant et protecteur.
Indiqué pour fraisage, alésage, filetage, perçage, et usinages pour machines automatiques.
Haute résistance à l'oxydation.
Lavable à l'eau. Sans solvants.



ml	CHF		
400	8.85	12	097380040
400		12	097381040
400		12	097382040

9740 - Brake Cleaner

nettoyant pour freins

Idéal pour le nettoyage des disques et des pastilles de freins, des moteurs.

Élimine la graisse et le goudron sans laisser de résidus.

À évaporation rapide.

N'attaque pas le caoutchouc et le plastique.



ml	CHF		
500	8.00	12	097400050
500		12	097401050
500		12	097402050

9741 - Multi Cleaner

Détergent, dégraissant multifonctions

Détergent et dégraissant pour dissoudre le gras, l'huile, le goudron, le silicone et la colle.

Recommandé pour le nettoyage des surfaces en métal, plastique rigide, céramique, acier et aluminium.

Ne laisse pas de résidus huileux.



ml	CHF		
400	8.75	12	097410040
400		12	097411040
400		12	097412040

9742 - Contact Cleaner

nettoyant pour contacts électriques et électroniques

Élimine le gras et la saleté sans laisser de résidus huileux.

À évaporation rapide.

N'attaque pas le plastique et le caoutchouc.



ml	CHF		
400	8.35	12	097420040
400		12	097421040
400		12	097422040

9743 - SURFACE CLEANER

Nettoyant antibactérien moussant

Produit de nettoyage antibactérien moussant, idéal pour tous les types de surfaces, d'outils et de tissus.

À base de sels d'ammonium quaternaire, il crée une mousse active qui nettoie et élimine la saleté et la graisse.

Élimine les mauvaises odeurs. Ne nécessite aucun rinçage n'est pas un désinfectant



ml	CHF		
500	17.00	12	097430050
500		12	097431050
500		12	097432050

9745 - Carb Cleaner

nettoyant pour carburateurs et corps à papillon

Spécifique pour le nettoyage interne et externe de carburateurs, conduits d'aspiration et corps papillon.

Élimine complètement les résidus carbonés, les dépôts et les impuretés.

Ne laisse pas de résidus huileux.



ml	CHF		
400	8.85	12	097450040
400		12	097451040
400		12	097452040

9746 - Clima Cleaner

nettoyant pour climatisation

Nettoyant pour climatiseurs industriels, civils et automobiles. Grâce à sa formulation en mousse épaisse et à la paillette qui l'accompagne, il permet d'éliminer la saleté, les dépôts et les odeurs des conduits tout en laissant un parfum agréable.



ml	CHF		
400	14.60	12	097460040
400		12	097461040
400		12	097462040

9749 - Air Spray

Spray d'air

Spray aérosol de gaz comprimé. Idéal pour éliminer les dépôts de poussière des fissures, équipements, pièces électriques, claviers et mécanismes délicats. La bombe aérosol avec paillette permet d'atteindre facilement les parties difficilement accessibles.



ml	CHF		
400	9.35	12	097490040
400		12	097491040
400		12	097492040

9752 - Zinc 98%

zinc clair

À haut pouvoir couvrant, idéal pour galvaniser les pièces en fer. Fortement adhésif, forme un film élastique de couleur très claire, semblable à la galvanisation à chaud. Particulièrement résistant à l'oxydation, à l'abrasion et aux agents atmosphériques. Peut être surverni. Ne coule pas.



ml	CHF		
400	10.20	12	097520040
400		12	097521040
400		12	097522040

9755 - Welding Spray

anti-adhérent soudure

Spray anti-adhérent soudure sans silicone. Il empêche l'adhérence, rendant ainsi le soudage plus facile et plus rapide. Pour une utilisation sur des pièces à souder et comme protecteur pour les buses de torche de soudage. Il permet d'effectuer des opérations ultérieures, par ex. peinture, galvanisation et chromage. Pas de fumées. Facile à retirer. Sans chlore.



ml	CHF		
400	9.25	12	097550040
400		12	097551040
400		12	097552040

9765 - Deicer Spray

Dégivrant

Spray dégivrant et dégivreur, pour enlever la glace et le givre des fenêtres. Idéal également pour les serrures et mécanismes gelés. Efficace jusqu'à -40 °C. Non gras, sans frottis. N'affecte pas les surfaces traitées, le caoutchouc et les plastiques.



ml	CHF		
400	15.40	12	097650040
400		12	097651040
400		12	097652040

9775 - Water Stop

Imperméabilisant pour tissus

Spray imperméabilisant et déperlant pour textiles et cuir. Idéal pour les chaussures, les vestes et les vêtements en général. Il permet aux tissus d'être imperméabilisés, sans affecter la respirabilité. En raison de ses propriétés de résistance aux taches, les tissus sont plus faciles à laver. Meilleure résistance à la flexion et à l'abrasion.



ml	CHF		
400	16.60	12	097750040
400		12	097751040
400		12	097752040

9881U

Détergent industriel alcalin pour cuve à ultrasons

Détergent industriel alcalin, concentré, à base d'eau. Pour nettoyage à ultrasons et autres processus de purification.

Permet un nettoyage minutieux et efficace des pièces de rechange et des pièces métalliques en général (injecteurs, carburateurs, vannes etc.). Élimine les huiles, les graisses, les lubrifiants, les résidus de colle, de résines, de cires. Également adapté au nettoyage de pièces en aluminium.



Lt	CHF		
1	42.50	1	098810010
1		1	098812010

9882R

Liquide détachant sélectif de rouille

Liquide détachant sélectif de rouille à base d'eau pour fer, acier, acier inox, fonte et chromages.

Élimine la couche oxydée sans endommager le substrat métallique.

Dilution : de pur à max. 1:1.

Température minimale d'utilisation : 15 °C.

Durée d'utilisation : 30' - 24/48h (pour rouille résistante).

Biodégradable et 100 % hydrosoluble.



Lt	CHF		
1	52.00	1	098820010
1		1	098822010



Une gamme complète d'abrasifs rigides et flexibles comprenant plus de 500 références entièrement produites en Italie. Conçue et développée pour répondre à toutes les exigences industrielles et professionnelles de coupe et d'élimination de matériau.

Avec le projet Beta Abrasives, Beta Utensili affirme sa volonté de proposer une gamme de produits complète et un service technique absolu aux professionnels du marché, garantis par les compétences de production mises à disposition par AbraBeta.

DISQUES RIGIDES À TRONÇONNER ET D'ÉBAVURAGE



Les disques rigides représentent la principale catégorie de cette nouvelle famille de produits ; pour cette raison, Beta Utensili a accordé la plus grande attention au choix des matériaux utilisés et aux typologies adoptées.

Les disques à tronçonner et d'ébavurage sont les instruments les plus rapides et polyvalents pour l'usinage d'une grande variété de matériaux avec les outils les plus indiqués, qu'il s'agisse de meuleuses à renvoi d'angle ou de machines stationnaires.

DISC SHAPES

T42

disque à tronçonner à moyeu déporté

T41

disque à tronçonner à moyeu plat

T27

disque d'ébavurage à moyeu déporté

TOP

— LINE —

La qualité sans conditions : destinées à des utilisateurs extrêmement exigeants

PREMIUM

— LINE —

Haute qualité pour grandes prestations, avec un prix compétitif pour le meilleur rapport qualité/prix.

CERTIFICATION



PICTOGRAMMES présents sur les disques



Utiliser des lunettes de protection



Utiliser des gants de protection



Utiliser un casque antibruit



Utiliser des vêtements de protection



Utiliser un masque de protection contre la poussière



Consulter le manuel d'instructions



Disque seulement pour le tronçonnage – non adapté à l'ébavurage



Ne pas utiliser le disque s'il est abîmé



Sans fer, soufre ni chlore ($\leq 0,1\%$)

Validité du produit

La validité des disques est de 3 ans à compter de la date de fabrication. L'expression "V01" gravée sur la rondelle métallique au centre du disque indique le trimestre d'expiration. Exemple : l'inscription "V07/2022" indique que le disque a été fabriqué au cours du 3ème trimestre 2019 et peut être utilisé jusqu'à la fin du 3ème trimestre 2022.



	Trimestre
V01	Jan-Mar
V04	Avr-Jui
V07	Jui-Sep
V10	Oct-Déc



MEULES SUR TIGE

Meules sur tige pour utilisation avec meuleuses droites. Réalisées en différentes formes pour s'adapter aux différents usinages et avec trois typologies d'abrasif.



ROUES SUR TIGE

Les roues à lamelles sur tige sont fabriquées avec des lamelles flexibles pour obtenir des finitions précises et homogènes sur des formes et des surfaces irrégulières.



DISQUES À LAMELLES

Les disques à lamelles sont composés de lamelles de toile abrasive collées à un support ; ils représentent le choix parfait pour les opérations de dégrossissage et de finition. Par rapport aux disques d'ébavurage, ils garantissent une élimination plus rapide, une finition plus homogène, réduisent les vibrations, le bruit et permettent de travailler à des températures inférieures. Ils sont disponibles avec des toiles de différents matériaux abrasifs avec plusieurs granulométries et deux types de support.

Exécutions

Profil plat

à utiliser avec un angle maximal de 15° par rapport au plan de travail et permet le travail sur surfaces plates et saillies.

Profil conique

Simplifie les opérations sur les surfaces irrégulières et s'utilise avec un angle compris entre 15° et 25° par rapport au plan de travail. Garantit une plus grande surface de contact entre le disque et la surface de travail. Les lamelles peuvent être utilisées jusqu'à leur usure complète.

TOP
— LINE —

La qualité sans conditions : destinées à des utilisateurs extrêmement exigeants.

PREMIUM
— LINE —

Haute qualité pour grandes prestations, avec un prix compétitif pour le meilleur rapport qualité/prix.



ROUES AVEC ALÉSAGE

Les roues à lamelles sur bride sont des produits aptes à l'usinage de bords, contours et surfaces irréguliers grâce à la grande flexibilité des lamelles.



ROUES POUR SATINEUSES

Les roues (ou rouleaux) pour satineuses Beta représentent la solution idéale pour la finition de tout matériau.

Degrés de grain/finition

C	Grossier
M	Moyen
F	Fin
VF	Très fin
UF	Ultra fin



DISQUES ABRASIFS ET DISQUES FIBRES

Disques spéciaux non-tissés avec grande capacité de polissage qui permettent des usinages rapides et précises.



ROULEAUX

Vaste gamme de rouleaux de toile et papier abrasif et non-tissés, d'excellente qualité pour toutes les utilisations.

Pour toute autre information, veuillez consulter le catalogue en ligne sur le site de Beta Utensili : www.beta-tools.com

11001

Disques à tronçonner à moyeu déporté pour l'acier Performance élevée et bonne durée de vie

A30S EN 12413



A30S

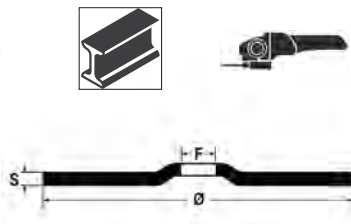

	Ø	S	F	max.	CHF		
	mm	mm	mm	rpm			
11001	115	3,2	22,23	13300	2.11	10	110010118
11001	125	3,2	22,23	12200	2.24	10	110010128
11001	230	3,2	22,23	6600	4.85	10	110010233

11001H

Disques à tronçonner à moyeu déporté pour l'acier Performance élevée et bonne durée de vie

HARD

A30T EN 12413



A30T

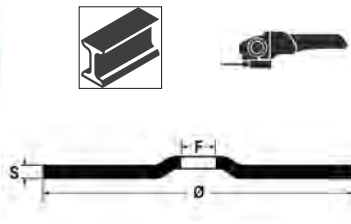

	Ø	S	F	max.	CHF		
	mm	mm	mm	rpm			
11001H	230	3,2	22,23	6600	4.85	10	110010733

11003

Disques à tronçonner plat pour l'acier Performance élevée et bonne durée de vie

A30T EN 12413



A30T

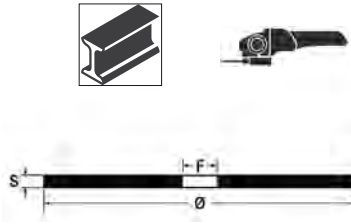

	Ø	S	F	max.	CHF		
	mm	mm	mm	rpm			
11003	115	2,5	22,23	13300	1.99	10	110030117
11003	125	2,5	22,23	12200	1.99	10	110030127
11003	180	2,5	22,23	8500	4.10	10	110030182
11003	230	2,5	22,23	6600	4.60	10	110030232

11011

Disques à ébarber pour l'acier à moyeu déporté Enlèvement de matière élevé

A24N EN 12413



A24N

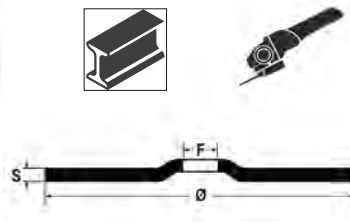

	Ø	S	F	max.	CHF		
	mm	mm	mm	rpm			
11011	115	6,5	22,23	13300	2.86	10	110110115
11011	125	6,5	22,23	12200	3.10	10	110110125
11011	180	6,5	22,23	8500	5.95	10	110110180
11011	230	6,5	22,23	6600	8.95	10	110110230

11011H

Disques à ébarber pour l'acier à moyeu déporté Enlèvement de matière élevé et bonne durée de vie

HARD

A24R EN 12413



A24R

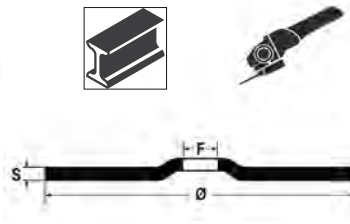

	Ø	S	F	max.	CHF		
	mm	mm	mm	rpm			
11011H	115	6,5	22,23	13300	2.86	10	110110615
11011H	125	6,5	22,23	12200	3.10	10	110110625
11011H	180	6,5	22,23	8500	5.95	10	110110680
11011H	230	6,5	22,23	6600	8.95	10	110110730

11018

Disques Stationnaire à tronçonner plat pour l'acier

60 m/s

A46N EN 12413



A46N



	Ø	S	F	max.	CHF		
	mm	mm	mm	rpm			
11018	300	2,5	25,40	4010	7.95	10	110180030
11018	350	3,0	25,40	3440	12.40	10	110180035
11018	400	3,2	25,40	3010	15.80	10	110180040

11019

Disques Stationnaire à tronçonner plat pour l'acier

80 m/s

A24N EN 12413



A24N



	Ø	S	F	max.			
	mm	mm	mm	rpm	CHF		
11019	300	3,8	25,40	5100	9.70	10	110190030
11019	350	4,2	25,40	4400	14.60	10	110190035
11019	400	4,5	25,40	3800	19.00	10	110190040

11021

Disques à tronçonner à moyeu déporté pour l'acier et l'inco Performance élevée et bonne durée de vie

A30Q EN 12413



A30Q



	Ø	S	F	max.			
	mm	mm	mm	rpm	CHF		
11021	115	3,2	22,23	13300	2.11	10	110210118
11021	125	3,2	22,23	12200	2.24	10	110210128
11021	180	3,2	22,23	8500	4.20	10	110210183
11021	230	3,2	22,23	6600	4.85	10	110210233

11023

Disques à ébarber pour l'acier et l'inco à moyeu déporté Enlèvement de matière élevé

A24Q EN 12413



A24Q



	Ø	S	F	max.			
	mm	mm	mm	rpm	CHF		
11023	115	6,5	22,23	13300	2.86	10	110230115
11023	125	6,5	22,23	12200	3.10	10	110230125
11023	230	6,5	22,23	6600	8.95	10	110230230

11024

Disques à tronçonner épaisseur fine, à moyeu déporté pour l'acier et l'inco Performance élevée et bonne durée de vie

TOP LINE

A46U EN 12413



TOP LINE

A46U

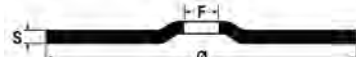

	Ø	S	F	max.			
	mm	mm	mm	rpm	CHF		
11024	230	2,0	22,23	6600	5.95	10	110240230

11031÷11038

Disques à tronçonner épaisseur fine, à moyeu plat pour l'acier et l'inco Haute performance et très longue durée de vie

TOP LINE

Ø 65 mm

A46U EN 12413



TOP LINE

A46U

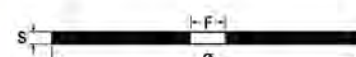

	Ø	S	F	max.			
	mm	mm	mm	rpm	CHF		
11031	65	1,0	6,00	24000	1.86	25	110310006
11031	65	1,0	10,00	24000	1.86	25	110310010
11031	65	1,6	10,00	24000	1.86	25	110310020

	Ø	S	F	max.			
	mm	mm	mm	rpm	CHF		
11032	76	1,0	6,00	20200	1.86	25	110320006
11032	76	1,0	10,00	20200	1.86	25	110320010
11032	76	1,6	10,00	20200	1.86	25	110320020

	Ø	S	F	max.			
	mm	mm	mm	rpm	CHF		
11034	115	1,0	22,23	13300	2.73	25	110340022
11034	115	1,2	22,23	13300	2.73	25	110340042
11034	115	1,6	22,23	13300	2.73	25	110340062

	Ø	S	F	max.			
	mm	mm	mm	rpm	CHF		
11035	125	1,0	22,23	12200	2.98	25	110350022
11035	125	1,2	22,23	12200	2.98	25	110350042
11035	125	1,6	22,23	12200	2.98	25	110350062

	Ø	S	F	max.			
	mm	mm	mm	rpm	CHF		
11037	180	2,0	22,23	8500	4.85	10	110370022

	Ø	S	F	max.			
	mm	mm	mm	rpm	CHF		
11038	230	2,0	22,23	6600	5.60	10	110380022

11040

Disques à tronçonner épaisseur fine, à moyeu déporté pour l'acier et l'inco Haute performance et très longue durée de vie

PREMIUM LINE

A36Q EN 12413

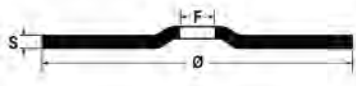

	Ø	S	F	max.			
	mm	mm	mm	rpm	CHF		
11040	230	2,0	22,23	6600	4.60	10	110400230

11045-11046

Disques à tronçonner épaisseur fine, à moyeu plat pour l'acier et l'inco Performance élevée et très bonne durée de vie

PREMIUM LINE

Ø 115 mm

A46Q EN 12413

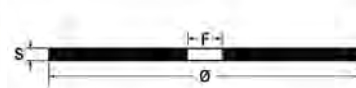

	Ø	S	F	max.			
	mm	mm	mm	rpm	CHF		
11045	115	1,0	22,23	13300	2.11	25	110450010
11045	115	1,2	22,23	13300	2.11	25	110450012
11045	115	1,6	22,23	13300	2.11	25	110450016

	Ø	S	F	max.			
	mm	mm	mm	rpm	CHF		
11046	125	1,0	22,23	12200	2.24	25	110460010
11046	125	1,2	22,23	12200	2.24	25	110460012
11046	125	1,6	22,23	12200	2.24	25	110460016

11048-11049

Disques à tronçonner épaisseur fine, à moyeu plat pour l'acier et l'inco Performance élevée et très bonne durée de vie

Ø 180 mm

A36Q EN 12413



	Ø	S	F	max.			
	mm	mm	mm	rpm	CHF		
11048	180	2,0	22,23	8500	3.25	10	110480019

	Ø	S	F	max.			
	mm	mm	mm	rpm	CHF		
11049	230	2,0	22,23	6600	4.35	10	110490019

11050

Disques à ébarber en corindon zirconium Très haut enlèvement de matière et très bonne durée de vie

ZA24R - EN 12413

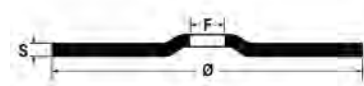
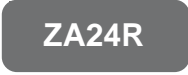

	Ø	S	F	max.			
	mm	mm	mm	rpm	CHF		
11050	115	6,5	22,23	13300	4.85	10	110500115
11050	125	6,5	22,23	12200	5.85	10	110500125
11050	230	7,0	22,23	6600	14.60	10	110500230

11069

Disques à tronçonner à moyeu déporté pour matériaux de construction, béton, marbre

C30S EN 12413

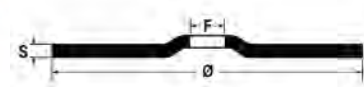

	Ø	S	F	max.			
	mm	mm	mm	rpm	CHF		
11069	115	3,2	22,23	13300	2.24	10	110690115
11069	125	3,2	22,23	12200	2.36	10	110690125
11069	230	3,2	22,23	6600	5.20	10	110690230

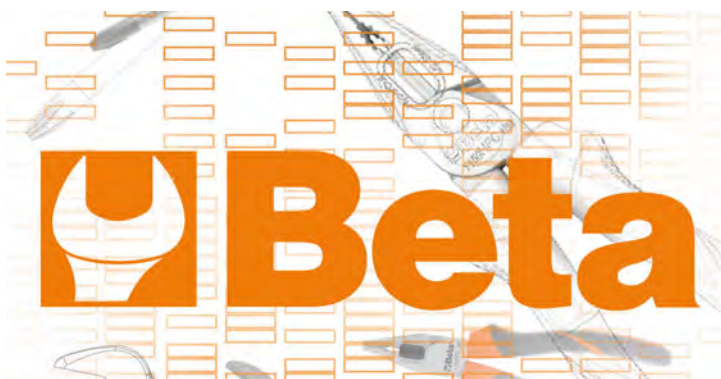

11100

Meule forme cylindrique sur tige au corindon rose avec liant céramique

tige Ø 3 x 37 mm

EN 12413

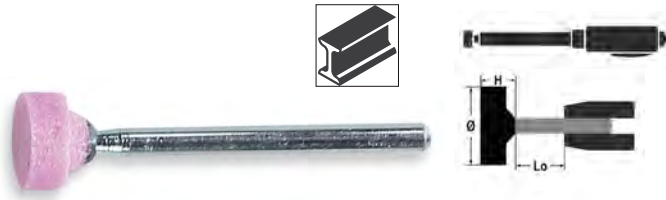

	Ø mm	h mm	max. rpm Lo=13 mm		CHF		
11100	4	8	130.000	AR60P5V	1.21	25	111000004
11100	6	10	93.100	AR60P5V	1.21	25	111000006
11100	8	12	64.500	AR60P5V	1.21	25	111000008
11100	10	10	60.100	AR60P5V	1.21	25	111000011
11100	10	12	52.700	AR60P5V	1.21	25	111000012
11100	12	15	37.300	AR60P5V	1.33	25	111000013

11101

Meule forme cylindrique sur tige au corindon rose avec liant céramique

tige Ø 6 x 40 mm

EN 12413



	Ø mm	h mm	max. rpm Lo=13 mm		CHF		
11101	4	8	130.000	AR60P5V	1.42	25	111010004
11101	5	10	130.000	AR60P5V	1.42	25	111010005
11101	6	10	130.000	AR60P5V	1.42	25	111010006
11101	8	10	119.300	AR60P5V	1.42	25	111010008
11101	10	10	95.400	AR60P5V	1.42	25	111010010
11101	10	15	95.400	AR60P5V	1.42	25	111010011
11101	10	20	86.600	AR60P5V	1.54	25	111010012
11101	10	25	72.700	AR60P5V	1.70	25	111010013
11101	10	32	58.700	AR60P5V	1.79	25	111010014
11101	12	10	79.500	AR60P5V	1.31	25	111010015
11101	12	15	79.500	AR60P5V	1.33	25	111010016
11101	12	20	79.500	AR60P5V	1.46	25	111010017
11101	15	3	63.600	AR60P5V	1.31	25	111010018
11101	15	15	63.600	AR60P5V	1.42	25	111010019
11101	16	20	59.600	AR46P5V	1.59	25	111010020
11101	16	25	56.900	AR46P5V	1.70	25	111010021
11101	16	32	45.100	AR46P5V	1.91	25	111010022
11101	20	4	47.700	AR60P5V	1.31	25	111010023
11101	20	15	47.700	AR46P5V	1.42	25	111010024
11101	20	20	47.700	AR46P5V	1.70	25	111010025
11101	20	25	46.100	AR46P5V	1.79	25	111010026
11101	20	30	38.900	AR46P5V	1.96	25	111010027
11101	20	40	29.000	AR46P5V	2.46	25	111010028
11101	25	10	38.100	AR60P5V	1.42	25	111010030
11101	25	25	37.200	AR36/46P5V	1.96	25	111010031
11101	25	40	23.300	AR36/46P5V	2.88	10	111010032
11101	30	10	31.800	AR60P5V	1.59	25	111010034
11101	30	30	26.200	AR36/46P5V	2.35	25	111010035
11101	30	40	19.500	AR36/46P5V	3.10	10	111010036
11101	32	20	29.800	AR36P5V	2.20	25	111010037
11101	32	32	23.100	AR36P5V	3.00	10	111010038
11101	40	10	23.800	AR36/46P5V	2.35	25	111010041
11101	40	20	23.800	AR36P5V	3.10	10	111010042
11101	40	25	23.400	AR36P5V	3.30	10	111010043
11101	40	30	19.700	AR36P5V	3.60	10	111010044
11101	40	40	14.700	AR36P5V	4.35	10	111010045
11101	50	15	19.000	AR36P5V	3.50	10	111010051
11101	50	25	18.800	AR36P5V	4.15	10	111010052
11101	60	10	15.900	AR36P5V	3.85	10	111010060

11102

Meule forme cylindrique sur tige au corindon rose avec liant céramique

tige Ø 6 x 80 mm

EN 12413

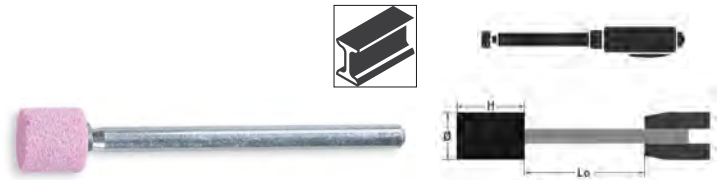

	Ø mm	h mm	max. rpm Lo=13 mm		CHF		
11102	8	20	100.500	AR60P5V	1.84	25	111020008
11102	10	15	95.400	AR60P5V	1.74	25	111020010
11102	10	30	62.200	AR60P5V	2.13	25	111020020
11102	12	15	79.500	AR60P5V	1.79	25	111020022
11102	15	15	63.600	AR60P5V	1.91	25	111020035
11102	15	30	51.000	AR46P5V	2.39	25	111020040
11102	20	30	38.900	AR46P5V	2.41	25	111020060

11105

Meule forme spéciale cylindrique triangulaire sur tige au corindon rose avec liant céramique

tige Ø 6 x 40 mm

EN 12413



	Ø mm	h mm	max. rpm Lo=13 mm		CHF		
11105	20	65	16.200	AR36/46P5V	4.60	25	111050020

11106

Meule forme trapézoïdale sur tige au corindon rose avec liant céramique

tige Ø 3 x 37 mm

EN 12413

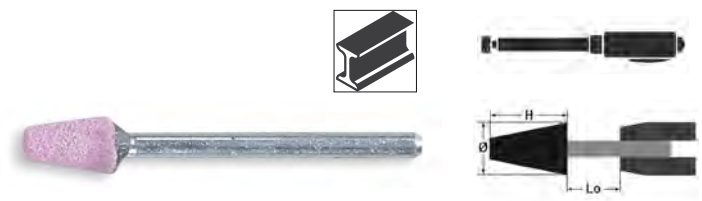

	Ø mm	h mm	max. rpm Lo=13 mm		CHF		
11106	6	10	93.100	AR60P5V	1.59	25	111060006

11107

Meule forme trapézoïdale sur tige au corindon rose avec liant céramique

tige Ø 6 x 40 mm
EN 12413



	Ø mm	h mm	max. rpm Lo=13 mm		CHF		
11107	12	20	79.500	AR60P5V	1.79	25	111070012
11107	15	25	60.400	AR46P5V	2.13	25	111070015
11107	20	30	38.900	AR46P5V	2.46	25	111070020
11107	25	40	23.300	AR36/46P5V	3.60	10	111070025

11110

Meule forme conique bout arrondi sur tige au corindon rose avec liant céramique

tige Ø 3 x 37 mm
EN 12413

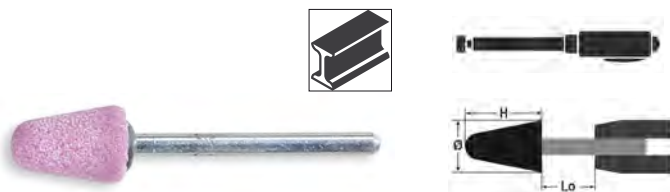

	Ø mm	h mm	max. rpm Lo=13 mm		CHF		
11110	10	15	44.300	AR60P5V	1.59	25	111100010

11111

Meule forme conique bout arrondi sur tige au corindon rose avec liant céramique

tige Ø 6 x 40 mm
EN 12413

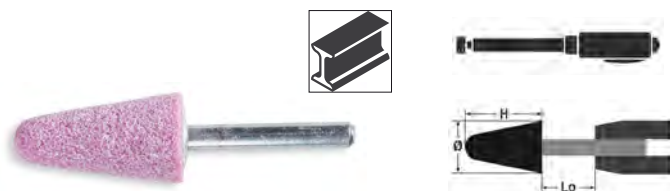

	Ø mm	h mm	max. rpm Lo=13 mm		CHF		
11111	10	20	86.600	AR60P5V	1.84	25	111110010
11111	15	30	51.000	AR46P5V	2.41	25	111110015
11111	16	45	31.400	AR46P5V	3.30	25	111110016
11111	20	28	41.500	AR46P5V	2.46	25	111110020
11111	20	40	29.000	AR46P5V	3.10	25	111110021
11111	30	50	15.100	AR36/46P5V	4.60	10	111110030

11115

Meule forme ogive sur tige au corindon rose avec liant céramique

tige Ø 3 x 37 mm
EN 12413

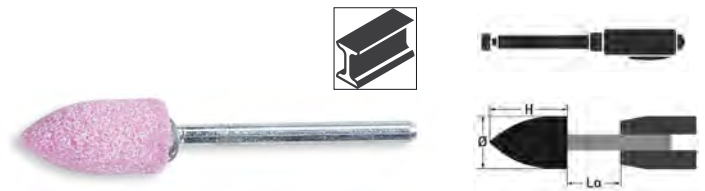

	Ø mm	h mm	max. rpm Lo=13 mm		CHF		
11115	10	20	34.700	AR60P5V	1.70	25	111150010

11116

Meule forme ogive sur tige au corindon rose avec liant céramique

tige Ø 6 x 40 mm
EN 12413

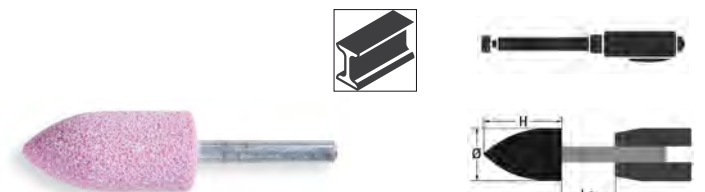

	Ø mm	h mm	max. rpm Lo=13 mm		CHF		
11116	10	20	86.600	AR60P5V	1.84	25	111160010
11116	18	30	43.000	AR46P5V	2.46	25	111160018
11116	20	50	22.500	AR36/46P5V	3.85	25	111160020
11116	22	70	13.400	AR36/46P5V	5.85	10	111160022

11120

Meule forme spéciale cylindrique pyramidale sur tige au corindon rose avec liant céramique

tige Ø 3 x 37 mm
EN 12413

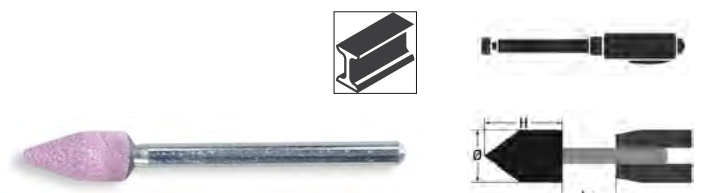

	Ø mm	h mm	max. rpm Lo=13 mm		CHF		
11120	6	13	77.800	AR60P5V	1.59	25	111200006

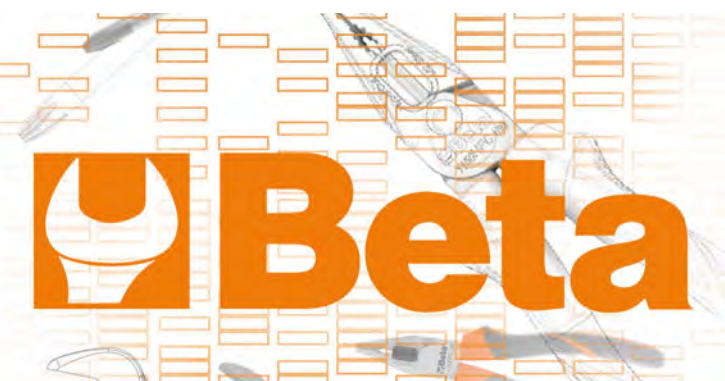

11121

Meule forme spéciale cylindrique pyramidale sur tige au corindon rose avec liant céramique

tige Ø 6 x 40 mm
EN 12413

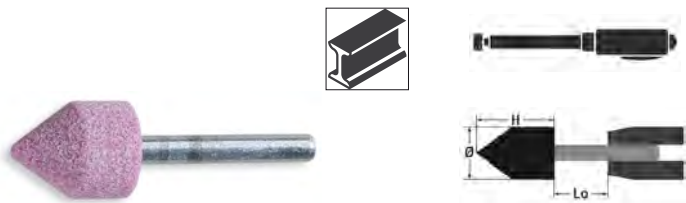

	Ø mm	h mm	max. rpm Lo=13 mm		CHF		
11121	6	25	100.700	AR60P5V	2.46	25	111210007
11121	12	20	79.500	AR60P5V	1.79	25	111210012
11121	20	25	46.100	AR46P5V	2.22	25	111210020
11121	25	25	37.200	AR36/46P5V	2.46	25	111210025
11121	30	30	26.200	AR36/46P5V	2.93	25	111210030

11125

Meule forme cylindrique bout arrondi sur tige au corindon rose avec liant céramique

tige Ø 6 x 40 mm
EN 12413

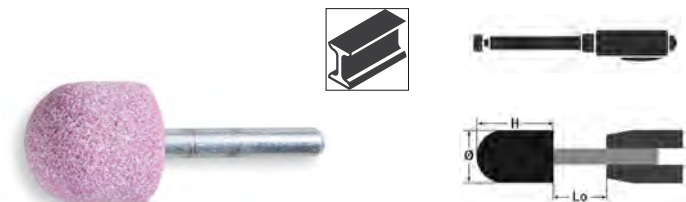

	Ø mm	h mm	max. rpm Lo=13 mm		CHF		
11125	6	20	117.700	AR60P5V	2.00	25	111250006
11125	25	25	37.200	AR36/46P5V	2.46	25	111250025
11125	30	50	15.100	AR36/46P5V	4.60	10	111250030
11125	40	40	14.700	AR36P5V	5.60	10	111250040

11130

Meule forme cylindrique bout arrondi sur tige au corindon rose avec liant céramique

tige Ø 3 x 37 mm
EN 12413

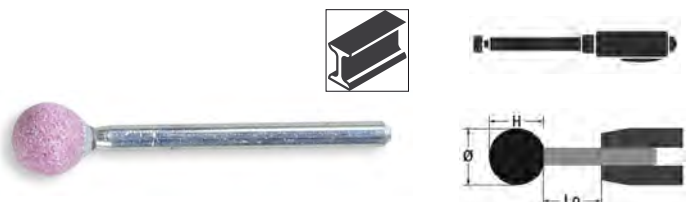

	Ø mm	h mm	max. rpm Lo=13 mm		CHF		
11130	6	6	124.900	AR60P5V	1.59	25	111300006
11130	8	8	84.800	AR60P5V	1.59	25	111300008
11130	10	10	60.100	AR60P5V	1.59	25	111300010

11131

Meule forme sphérique sur tige au corindon rose avec liant céramique

tige Ø 6 x 40 mm
EN 12413

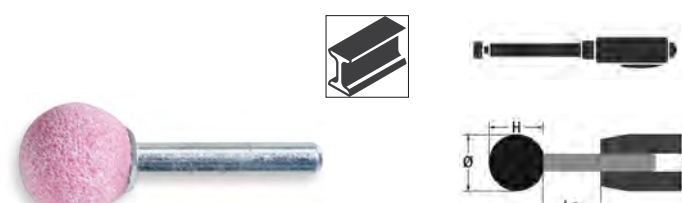

	Ø mm	h mm	max. rpm Lo=13 mm		CHF		
11131	10	10	95.400	AR60P5V	1.70	25	111310010
11131	15	15	63.600	AR60P5V	1.79	25	111310015
11131	20	20	47.700	AR46P5V	2.13	25	111310020
11131	25	25	37.200	AR36/46P5V	2.46	25	111310025
11131	30	30	26.200	AR36/46P5V	2.93	25	111310030

11132

Meule forme sphérique sur tige au corindon rose avec liant céramique

tige Ø 6 x 80 mm
EN 12413

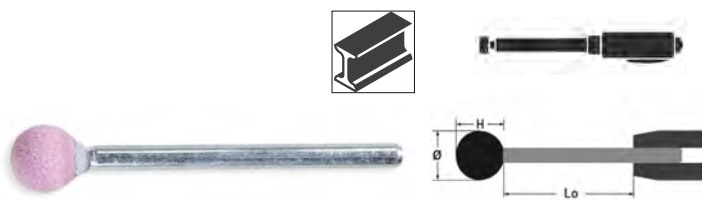

	Ø mm	h mm	max. rpm Lo=13 mm		CHF		
11132	10	10	95.400	AR60P5V	2.00	25	111320010
11132	15	15	63.600	AR60P5V	2.22	25	111320015
11132	20	20	47.700	AR46P5V	2.63	25	111320020

11135

Meule en forme de disque sur tige au corindon rose avec liant céramique

tige Ø 6 x 40 mm
EN 12413

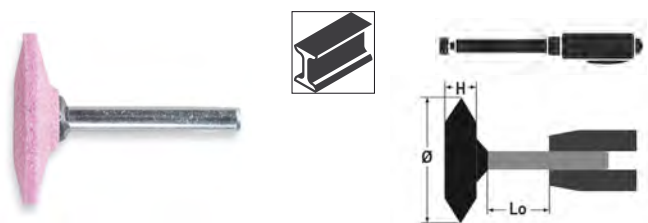

	Ø mm	h mm	max. rpm Lo=13 mm		CHF		
11135	30	6	31.800	AR60P5V	1.96	25	111350030
11135	40	10	23.800	AR36/46P5V	3.00	25	111350040

11140

Meule forme cylindrique sur tige au corindon gris/rose

tige Ø 6 x 40 mm

EN 12413

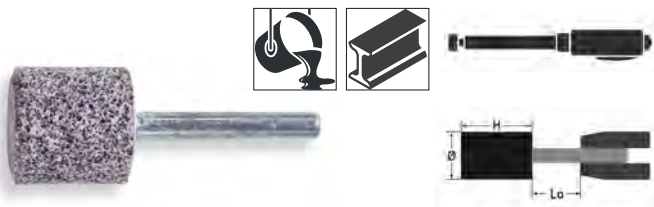

	Ø mm	h mm	max. rpm Lo=13 mm		CHF		
11140	20	30	38.900	A/AR24R5V	1.96	25	111400020
11140	25	25	37.200	A/AR24R5V	1.96	25	111400025
11140	30	30	26.200	A/AR24R5V	2.35	25	111400030
11140	50	10	19.000	A/AR24R5V	3.10	10	111400050

11141

Meule forme cylindrique sur tige au corindon gris/rose

tige Ø 6 x 80 mm

EN 12413

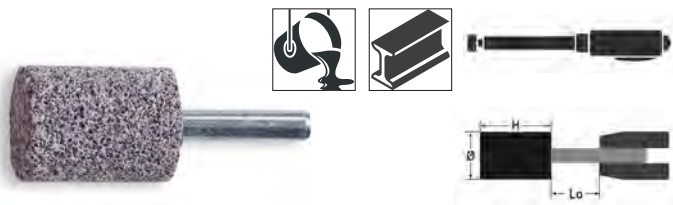

	Ø mm	h mm	max. rpm Lo=13 mm		CHF		
11141	20	40	46.800	A/AR24R5V	2.77	25	111410020
11141	30	40	31.800	A/AR24R5V	3.35	10	111410030
11141	40	40	23.800	A/AR24R5V	4.70	10	111410040

11145

Meule en forme d'ogive sur tige au corindon gris/rose

tige Ø 6 x 40 mm

EN 12413

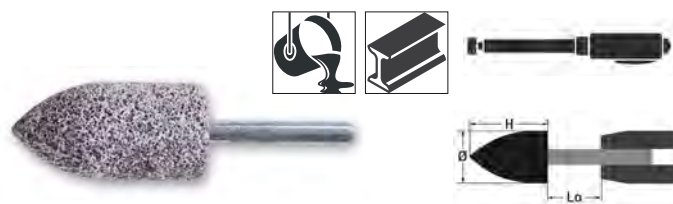

	Ø mm	h mm	max. rpm Lo=13 mm		CHF		
11145	20	30	38.900	A/AR24R5V	2.46	25	111450020
11145	25	50	18.100	A/AR24R5V	4.35	10	111450025

11200A-11200B

Disque à lamelles plat Zirconium avec support plastique. Gamme Premium avec double lamelles pour enlèvement plus agressif et longue durée de vie

Exécution plate

PREMIUM LINE

Ø 115 mm

EN 13743

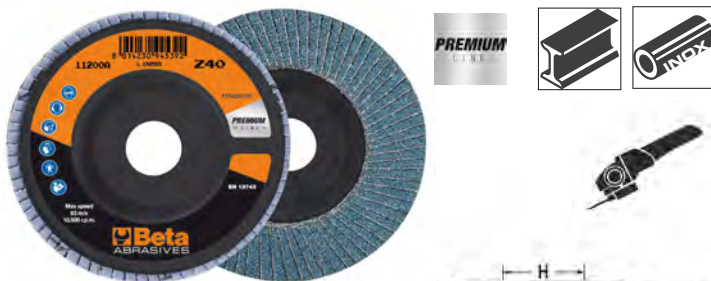

	Ø mm	P	F mm		CHF		
11200A	115	40	22,23		3.50	10	112000004
11200A	115	60	22,23		3.50	10	112000006
11200A	115	80	22,23		3.50	10	112000008
11200A	115	120	22,23		3.50	10	112000012

	Ø mm	P	F mm		CHF		
11200B	125	40	22,23		4.20	10	112000104
11200B	125	60	22,23		4.20	10	112000106
11200B	125	80	22,23		4.20	10	112000108

11202A-11202C

Disque à lamelles plat Zirconium avec support plastique. Gamme Premium avec double lamelles pour enlèvement plus agressif et longue durée de vie

Exécution plate

PREMIUM LINE

Ø 115 mm

EN 13743

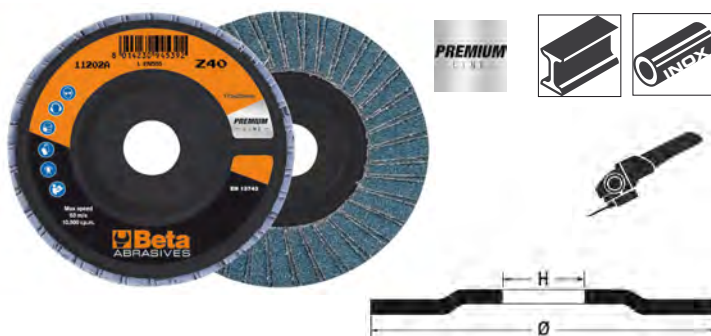

	Ø mm	P	F mm		CHF		
11202A	115	40	22,23		3.50	10	112020004
11202A	115	60	22,23		3.50	10	112020006
11202A	115	80	22,23		3.50	10	112020008
11202A	115	120	22,23		3.50	10	112020012

	Ø mm	P	F mm		CHF		
11202B	125	40	22,23		4.20	10	112020104
11202B	125	60	22,23		4.20	10	112020106
11202B	125	80	22,23		4.20	10	112020108

	Ø mm	P	F mm		CHF		
11202C	180	40	22,23		8.95	10	112020204
11202C	180	60	22,23		8.95	10	112020206

11204A÷11204C

Disque à lamelles plat Zirconium avec support fibre de verre. Gamme Premium avec simple lamelle pour un enlèvement de matière élevé et longue durée de vie

Exécution plate
PREMIUM LINE
Ø 115 mm
EN 13743

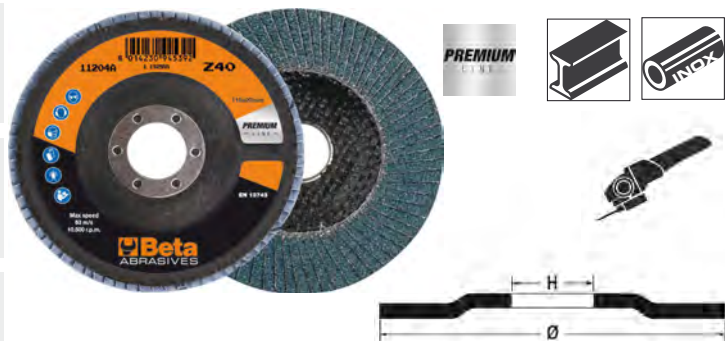

Ø mm	P	F mm	CHF		
11204A	115	40	22,23	3.50	10 112040004
11204A	115	60	22,23	3.50	10 112040006
11204A	115	80	22,23	3.50	10 112040008
11204A	115	120	22,23	3.50	10 112040012

Ø mm	P	F mm	CHF		
11204B	125	40	22,23	4.20	10 112040104
11204B	125	60	22,23	4.20	10 112040106
11204B	125	80	22,23	4.20	10 112040108

Ø mm	P	F mm	CHF		
11204C	180	40	22,23	8.95	10 112040204
11204C	180	60	22,23	8.95	10 112040206

11208A-11208B

Disque à lamelles plat Zirconium avec support fibre de verre. Gamme Premium avec double lamelles pour enlèvement plus agressif et longue durée de vie

Exécution plate
PREMIUM LINE
Ø 115 mm
EN 13743



Ø mm	P	F mm	CHF		
11208A	115	40	22,23	3.50	10 112080004
11208A	115	60	22,23	3.50	10 112080006

Ø mm	P	F mm	CHF		
11208B	125	40	22,23	4.20	10 112080104
11208B	125	60	22,23	4.20	10 112080106

11210A÷11210C

Disque à lamelles conique Zirconium avec support fibre de verre. Gamme Premium avec simple lamelle pour un enlèvement de matière élevé et longue durée de vie

Exécution conique
PREMIUM LINE
Ø 115 mm
EN 13743



Ø mm	P	F mm	CHF		
11210A	115	40	22,23	3.50	10 112100004
11210A	115	60	22,23	3.50	10 112100006
11210A	115	80	22,23	3.50	10 112100008
11210A	115	120	22,23	3.50	10 112100012

Ø mm	P	F mm	CHF		
11210B	125	40	22,23	4.20	10 112100104
11210B	125	60	22,23	4.20	10 112100106
11210B	125	80	22,23	4.20	10 112100108

Ø mm	P	F mm	CHF		
11210C	180	40	22,23	8.95	10 112100204
11210C	180	60	22,23	8.95	10 112100206

11212A-11212B

Disque à lamelles plat Zirconium avec support plastique. Gamme TOP LINE avec simple lamelle pour un enlèvement de matière maximum et très longue durée de vie

Exécution plate
TOP LINE
Ø 115 mm
EN 13743

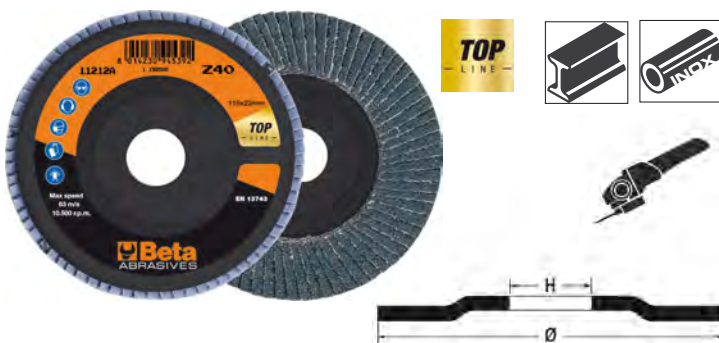

Ø mm	P	F mm	CHF		
11212A	115	40	22,23	4.35	10 112120004
11212A	115	60	22,23	4.35	10 112120006
11212A	115	80	22,23	4.35	10 112120008
11212A	115	120	22,23	4.35	10 112120012

Ø mm	P	F mm	CHF		
11212B	125	40	22,23	5.35	10 112120104
11212B	125	60	22,23	5.35	10 112120106
11212B	125	80	22,23	5.35	10 112120108

11214A÷11214C

Disque à lamelles plat Zirconium avec support plastique. Gamme TOP LINE avec double lamelles pour un enlèvement de matière très agressif et très longue durée de vie

Exécution plate
TOP LINE
Ø 115 mm
EN 13743

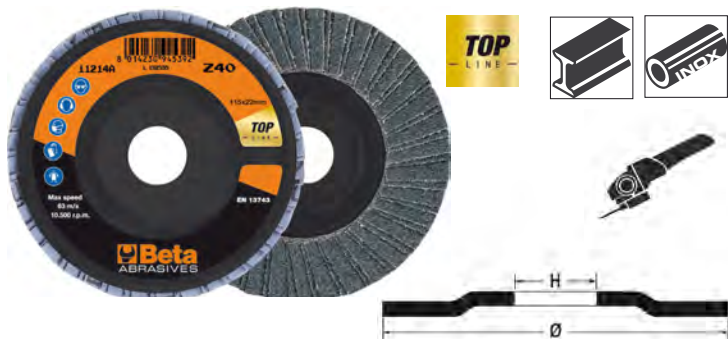

Ø mm	P	F mm	CHF		
11214A	115	40	22,23	4.35	10 112140004
11214A	115	60	22,23	4.35	10 112140006
11214A	115	80	22,23	4.35	10 112140008
11214A	115	120	22,23	4.35	10 112140012

Ø mm	P	F mm	CHF		
11214B	125	40	22,23	5.35	10 112140104
11214B	125	60	22,23	5.35	10 112140106
11214B	125	80	22,23	5.35	10 112140108

Ø mm	P	F mm	CHF		
11214C	180	40	22,23	10.90	10 112140204
11214C	180	60	22,23	10.90	10 112140206

11216A÷11216C

Disque à lamelles plat Zirconium avec support fibre de verre. Gamme TOP LINE avec simple lamelle pour un enlèvement de matière maximum et très longue durée de vie

Exécution plate
TOP LINE
Ø 115 mm
EN 13743



Ø mm	P	F mm	CHF		
11216A	115	40	22,23	4.35	10 112160004
11216A	115	60	22,23	4.35	10 112160006
11216A	115	80	22,23	4.35	10 112160008
11216A	115	120	22,23	4.35	10 112160012

Ø mm	P	F mm	CHF		
11216B	125	40	22,23	5.35	10 112160104
11216B	125	60	22,23	5.35	10 112160106
11216B	125	80	22,23	5.35	10 112160108

Ø mm	P	F mm	CHF		
11216C	180	40	22,23	10.90	10 112160204
11216C	180	60	22,23	10.90	10 112160206

11218A-11218B

Disque à lamelles plat Zirconium avec support fibre de verre. Gamme TOP LINE avec double lamelles pour un enlèvement de matière très agressif et très longue durée de vie

Exécution plate
TOP LINE
Ø 115 mm
EN 13743



Ø mm	P	F mm	CHF		
11218A	115	40	22,23	4.35	10 112180004
11218A	115	60	22,23	4.35	10 112180006

Ø mm	P	F mm	CHF		
11218B	125	40	22,23	5.35	10 112180104
11218B	125	60	22,23	5.35	10 112180106

11220A÷11220C

Disque à lamelles conique Zirconium avec support fibre de verre. Gamme TOP LINE avec simple lamelle pour un enlèvement de matière maximum et très longue durée de vie

Exécution conique
TOP LINE
Ø 115 mm
EN 13743



Ø mm	P	F mm	CHF		
11220A	115	40	22,23	4.35	10 112200004
11220A	115	60	22,23	4.35	10 112200006
11220A	115	80	22,23	4.35	10 112200008
11220A	115	120	22,23	4.35	10 112200012

Ø mm	P	F mm	CHF		
11220B	125	40	22,23	5.35	10 112200104
11220B	125	60	22,23	5.35	10 112200106
11220B	125	80	22,23	5.35	10 112200108

Ø mm	P	F mm	CHF		
11220C	180	40	22,23	10.90	10 112200204
11220C	180	60	22,23	10.90	10 112200206

11222

Disques à lamelles conique avec toile abrasive au zirconium, support en fibre de verre Gamme TOP avec double lamelle pour un enlèvement de matière très agressif et très longue durée de vie

Exécution conique
TOP LINE
Ø 115 mm
EN 13743

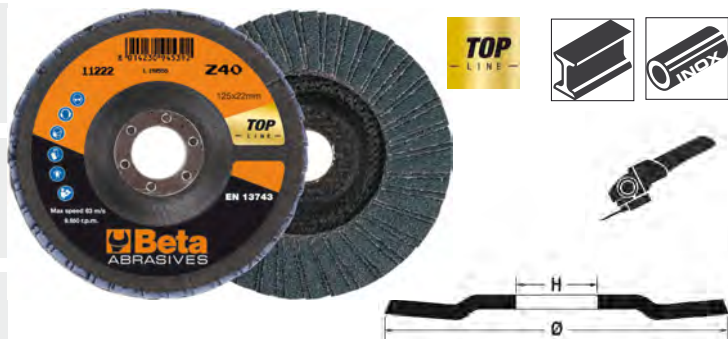

	Ø mm	P	F mm	CHF		
11222B	125	40	22,23	5.35	10	112220104
11222B	125	60	22,23	5.35	10	112220106
11222B	125	80	22,23	5.35	10	112220108

11230A-11230B

Disque à lamelles plat Corindon avec support plastique. Gamme Premium avec simple lamelle pour un bon enlèvement de matière et bonne durée de vie

Exécution plate
PREMIUM LINE
Ø 115 mm
EN 13743



	Ø mm	P	F mm	CHF		
11230A	115	40	22,23	3.25	10	112300004
11230A	115	60	22,23	3.25	10	112300006
11230A	115	80	22,23	3.25	10	112300008
11230A	115	120	22,23	3.25	10	112300012

	Ø mm	P	F mm	CHF		
11230B	125	40	22,23	3.95	10	112300104
11230B	125	60	22,23	3.95	10	112300106

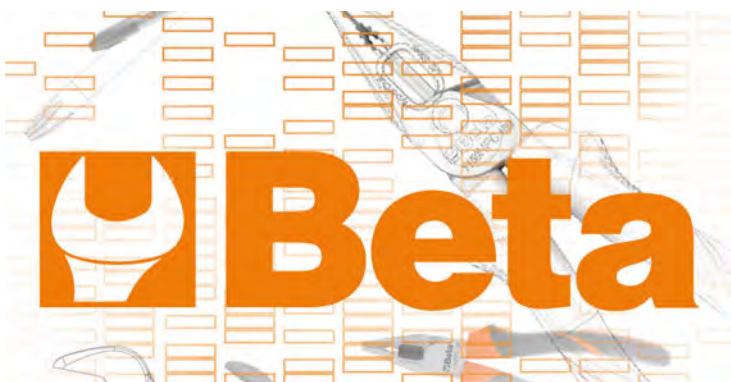

11232A

Disque à lamelles plat Corindon avec support plastique. Gamme TOP LINE avec double lamelles un très bon enlèvement de matière et très bonne durée de vie

Exécution plate
PREMIUM LINE
Ø 115 mm
EN 13743

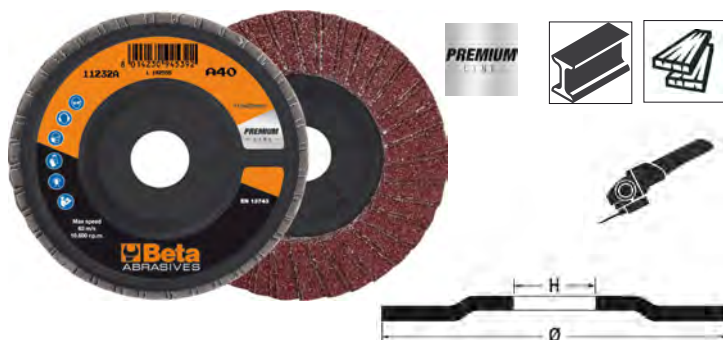

	Ø mm	P	F mm	CHF		
11232A	115	40	22,23	3.25	10	112320004
11232A	115	60	22,23	3.25	10	112320006
11232A	115	80	22,23	3.25	10	112320008
11232A	115	120	22,23	3.25	10	112320012

11234A-11234B

Disque à lamelles plat Corindon avec support fibre de verre. Gamme TOP avec simple lamelle pour un bon enlèvement de matière et bonne durée de vie

Exécution plate
TOP LINE
Ø 115 mm
EN 13743



	Ø mm	P	F mm	CHF		
11234A	115	40	22,23	3.85	10	112340004
11234A	115	60	22,23	3.85	10	112340006
11234A	115	80	22,23	3.85	10	112340008
11234A	115	120	22,23	3.85	10	112340012

	Ø mm	P	F mm	CHF		
11234B	125	40	22,23	4.85	10	112340104
11234B	125	60	22,23	4.85	10	112340106

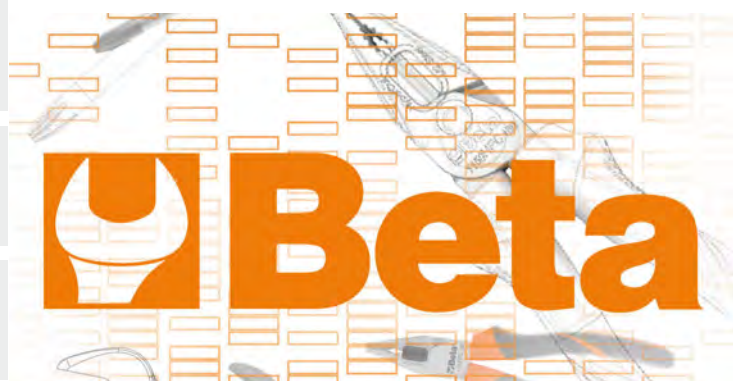

11240A-11240B

Disque à lamelles plat Zirconium Céramique avec support plastique.
Gamme TOP LINE avec simple lamelle pour agressivité maximum et très longue durée de vie

Exécution plate
Ø 115 mm
EN 13743

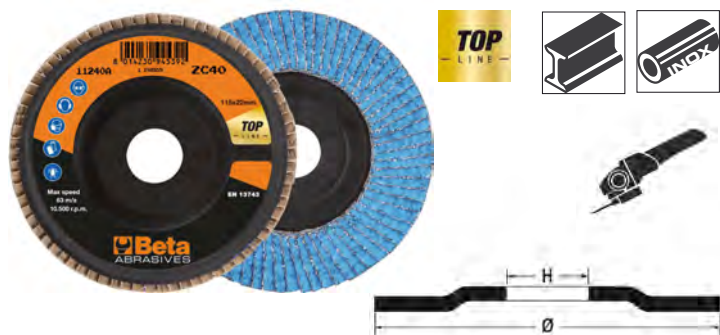

	Ø mm	P	F mm	CHF		
11240A	115	40	22,23	6.10	10	112400004
11240A	115	60	22,23	6.10	10	112400006

	Ø mm	P	F mm	CHF		
11240B	125	40	22,23	7.30	10	112400104
11240B	125	60	22,23	7.30	10	112400106

11242A-11242B

Disque à lamelles plat Zirconium Céramique avec support plastique.
Gamme TOP avec simple lamelle pour agressivité maximum et très longue durée de vie

Exécution plate
Ø 115 mm
EN 13743



	Ø mm	P	F mm	CHF		
11242A	115	40	22,23	6.10	10	112420004
11242A	115	60	22,23	6.10	10	112420006

	Ø mm	P	F mm	CHF		
11242B	125	40	22,23	7.30	10	112420104
11242B	125	60	22,23	7.30	10	112420106

11246A

Disque à lamelles plat Zirconium Céramique avec support plastique. Gamme TOP LINE avec simple lamelle pour agressivité maximum et très longue durée de vie

Exécution plate
Ø 115 mm
EN 13743



	Ø mm	P	F mm	CHF		
11246A	115	40	22,23	7.45	10	112460004
11246A	115	60	22,23	7.45	10	112460006

11248A-11248B

Disque à lamelles plat Céramique avec support fibre de verre. Gamme TOP LINE avec simple lamelle pour un rendement maximal

Exécution plate
Ø 115 mm
EN 13743



	Ø mm	P	F mm	CHF		
11248A	115	40	22,23	7.45	10	112480004
11248A	115	60	22,23	7.45	10	112480006

	Ø mm	P	F mm	CHF		
11248B	125	40	22,23	9.70	10	112480104
11248B	125	60	22,23	9.70	10	112480106

11259

Disques à lamelles en feutre pour polissage, support en fibre de verre et lamelle simple

Exécution plate



	Ø mm	F mm	CHF		
11259	115	22,23	12.20	10	112590115
11259	125	22,23	14.00	10	112590125

Beta

11260÷11268

Roue à lamelles sur tige

tige Ø 3 mm

EN 13743



Ø mm	h mm	S mm	P	CHF	📄	📧
11260	10	10	3	60	6.10	10 112600010
11260	15	15	3	60	4.85	10 112600015

Ø mm	h mm	S mm	P	CHF	📄	📧
11263	30	10	6	60	3.25	10 112630006
11263	30	15	6	60	3.25	10 112630016
11263	30	15	6	80	3.25	10 112630018
11263	30	20	6	40	3.25	10 112630024
11263	30	20	6	60	3.35	10 112630026
11263	30	20	6	80	3.35	10 112630028
11263	30	20	6	120	3.35	10 112630032

Ø mm	h mm	S mm	P	CHF	📄	📧
11264	40	15	6	60	3.50	10 112640006
11264	40	15	6	80	3.50	10 112640008
11264	40	15	6	120	3.50	10 112640012
11264	40	20	6	40	3.60	10 112640014
11264	40	20	6	60	3.60	10 112640016
11264	40	30	6	40	4.10	10 112640024
11264	40	30	6	60	4.10	10 112640026

Ø mm	h mm	S mm	P	CHF	📄	📧
11265	50	20	6	60	4.20	10 112650006
11265	50	20	6	80	4.20	10 112650008
11265	50	30	6	40	4.70	10 112650014
11265	50	30	6	60	4.70	10 112650016
11265	50	30	6	80	4.70	10 112650018
11265	50	30	6	120	4.95	10 112650022

Ø mm	h mm	S mm	P	CHF	📄	📧
11266	60	20	6	40	4.95	10 112660004
11266	60	20	6	60	4.95	10 112660006
11266	60	30	6	40	5.60	10 112660014
11266	60	30	6	60	5.60	10 112660016
11266	60	30	6	80	5.60	10 112660018
11266	60	30	6	120	6.10	10 112660022
11266	60	40	6	60	6.45	10 112660026
11266	60	40	6	80	6.45	10 112660028

Ø mm	h mm	S mm	P	CHF	📄	📧
11268	80	30	6	60	7.70	10 112680006
11268	80	30	6	80	7.70	10 112680008



11271A÷11271C

Roue abrasive non – tissé en corindon

Ø 40 mm
tige Ø 6 mm



Ø mm	h mm	S mm	P	CHF	📄	📧
11271A	40	20	6	C	8.05	10 112710001
11271A	40	20	6	M	8.05	10 112710002
11271A	40	20	6	F	8.05	10 112710003
11271A	40	20	6	VF	8.05	10 112710004

Ø mm	h mm	S mm	P	CHF	📄	📧
11271B	60	30	6	C	9.05	10 112710011
11271B	60	30	6	M	9.05	10 112710012
11271B	60	30	6	F	9.05	10 112710013
11271B	60	30	6	VF	9.05	10 112710014

Ø mm	h mm	S mm	P	CHF	📄	📧
11271C	80	50	6	C	10.10	10 112710021
11271C	80	50	6	M	10.10	10 112710022
11271C	80	50	6	F	10.10	10 112710023
11271C	80	50	6	VF	10.10	10 112710024

11276A÷11276C

Roue abrasive non-tissé avec toile abrasive intercalée en corindon

Ø 40 mm
tige Ø 6 mm



Ø mm	h mm	S mm	P	CHF	📄	📧
11276A	40	20	6	M/60	9.20	10 112760006
11276A	40	20	6	M/80	9.20	10 112760008
11276A	40	20	6	M/120	9.20	10 112760012

Ø mm	h mm	S mm	P	CHF	📄	📧
11276B	60	30	6	M/60	10.10	10 112760016
11276B	60	30	6	M/80	10.10	10 112760018
11276B	60	30	6	M/120	10.10	10 112760022

Ø mm	h mm	S mm	P	CHF	📄	📧
11276C	80	50	6	M/60	12.00	10 112760036
11276C	80	50	6	M/80	12.00	10 112760038
11276C	80	50	6	M/120	12.00	10 112760042

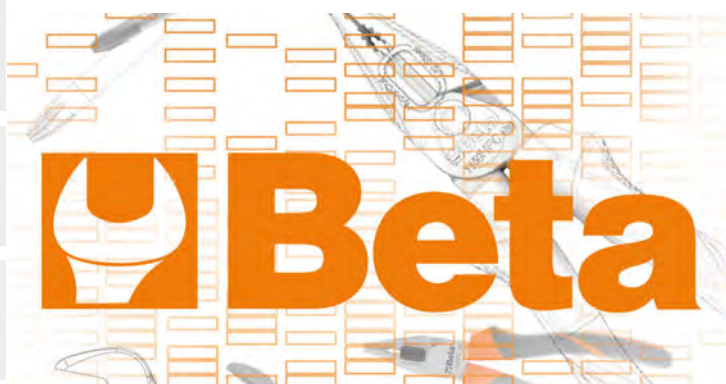

11300A÷11300G

Roue à lamelles avec alésage pour touret

Ø 165 x 30 mm
EN 13743

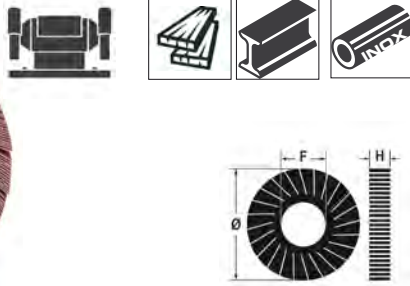

	Ø mm	H mm	P	F mm	CHF		
11300A	165	30	40	54	33.50	3	113000004
11300A	165	30	60	54	34.50	3	113000006
11300A	165	30	80	54	36.00	3	113000008
11300A	165	30	120	54	39.50	3	113000012
11300A	165	30	180	54	41.00	3	113000018
11300A	165	30	220	54	43.50	3	113000022
<hr/>							
	Ø mm	H mm	P	F mm	CHF		
11300B	165	50	40	54	46.00	2	113000104
11300B	165	50	60	54	48.50	2	113000106
11300B	165	50	80	54	49.50	2	113000108
11300B	165	50	120	54	54.50	2	113000112
11300B	165	50	180	54	60.50	2	113000118
11300B	165	50	220	54	64.50	2	113000122
<hr/>							
	Ø mm	H mm	P	F mm	CHF		
11300C	200	30	40	54	39.50	3	113000204
11300C	200	30	60	54	42.00	3	113000206
11300C	200	30	80	54	46.00	3	113000208
11300C	200	30	120	54	48.50	3	113000212
11300C	200	30	180	54	52.00	3	113000218
<hr/>							
	Ø mm	H mm	P	F mm	CHF		
11300D	200	50	40	54	54.50	2	113000304
11300D	200	50	60	54	60.50	2	113000306
11300D	200	50	80	54	64.50	2	113000308
11300D	200	50	120	54	70.50	2	113000312
11300D	200	50	180	54	77.00	2	113000318
11300D	200	50	220	54	83.00	2	113000322
<hr/>							
	Ø mm	H mm	P	F mm	CHF		
11300E	250	30	40	100	70.50	3	113000404
11300E	250	30	60	100	74.50	3	113000406
11300E	250	30	80	100	77.00	3	113000408
11300E	250	30	120	100	82.00	3	113000412
<hr/>							
	Ø mm	H mm	P	F mm	CHF		
11300F	250	50	40	100	101.50	2	113000504
11300F	250	50	60	100	104.00	2	113000506
11300F	250	50	80	100	106.50	2	113000508
11300F	250	50	120	100	110.50	2	113000512
11300F	250	50	180	100	130.00	2	113000518
11300F	250	50	220	100	142.50	2	113000522
<hr/>							
	Ø mm	H mm	P	F mm	CHF		
11300G	300	50	40	100	136.50	2	113000604
11300G	300	50	60	100	142.50	2	113000606
11300G	300	50	80	100	146.50	2	113000608

11320

Roue abrasive non tissée avec alésage pour touret

Ø 200 x 50 mm

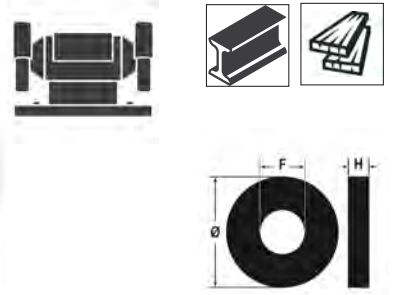

	Ø mm	H mm	P	F mm	CHF		
11320	200	50	C	76,2	41.00	2	113200006
11320	200	50	M	76,2	41.00	2	113200008
11320	200	50	F	76,2	41.00	2	113200012
11320	200	50	VF	76,2	41.00	2	113200024

11411

Rouleau à lamelles pour satineuse

Ø 100 x 100 mm
EN 13743

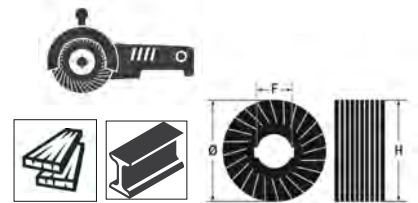

	Ø mm	H mm	P	F mm	CHF		
11411	100	100	40	19,1	34.50	2	114110004
11411	100	100	60	19,1	38.50	2	114110006
11411	100	100	80	19,1	39.50	2	114110008
11411	100	100	120	19,1	41.00	2	114110012
11411	100	100	240	19,1	42.00	2	114110024

11415B

Roue abrasive non-tissée pour satineuse

Ø 100 x 100 mm

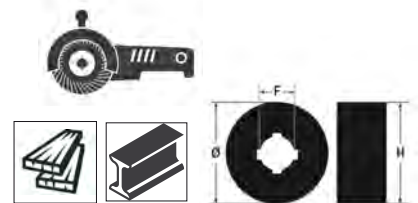

	Ø mm	H mm	P	F mm	CHF		
11415B	100	100	C	19,1	29.50	2	114150106
11415B	100	100	M	19,1	29.50	2	114150108
11415B	100	100	F	19,1	29.50	2	114150112
11415B	100	100	VF	19,1	29.50	2	114150124

11420B

Roue abrasive non-tissé avec lamelles toile intercalées pour satinéuse

Ø 100 x 100 mm

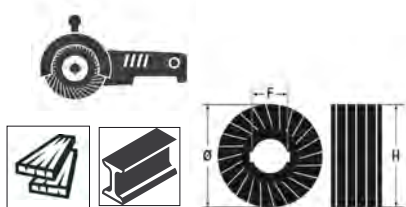

	Ø mm	H mm	P mm	F mm	CHF		
11420B	100	100	C/60	19,1	32.00	2	114200106
11420B	100	100	M/80	19,1	32.00	2	114200108
11420B	100	100	F/120	19,1	32.00	2	114200112
11420B	100	100	VF/240	19,1	32.00	2	114200124

11431

Disque abrasif non-tissé

Ø 115 mm

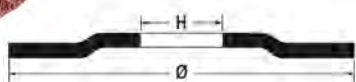

	Ø mm	P mm	F mm	CHF		
11431	115	C	22,23	18.60	4	114310006
11431	115	M	22,23	18.60	4	114310008
11431	115	F	22,23	18.60	4	114310012
11431	115	VF	22,23	18.60	4	114310024

11435

Disque abrasif non-tissé avec lamelles toile intercalées

Ø 115 mm

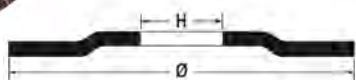

	Ø mm	P mm	F mm	CHF		
11435	115	M/80	22,23	22.30	4	114350008
11435	115	M/120	22,23	22.30	4	114350012
11435	115	F/150	22,23	22.30	4	114350015
11435	115	F/180	22,23	22.30	4	114350018

11440A÷11440C

Disque fibre zirconium

Ø 115 mm



	Ø mm	P mm	F mm	CHF		
11440A	115	24	22	1.62	25	114400024
11440A	115	36	22	1.62	25	114400036
11440A	115	60	22	1.49	25	114400060
11440A	115	120	22	1.49	25	114400120

	Ø mm	P mm	F mm	CHF		
11440B	125	24	22	1.86	25	114400224
11440B	125	36	22	1.86	25	114400236
11440B	125	60	22	1.74	25	114400260
11440B	125	120	22	1.74	25	114400320

	Ø mm	P mm	F mm	CHF		
11440C	180	24	22	2.98	25	114400424
11440C	180	36	22	2.98	25	114400436
11440C	180	60	22	2.86	25	114400460
11440C	180	120	22	2.86	25	114400520

11450A÷11450C

Disque fibre corindon

Ø 115 mm

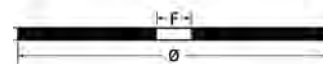

	Ø mm	P mm	F mm	CHF		
11450A	115	24	22	1.24	25	114500024
11450A	115	36	22	1.24	25	114500036
11450A	115	60	22	1.12	25	114500060
11450A	115	120	22	1.12	25	114500120

	Ø mm	P mm	F mm	CHF		
11450B	125	24	22	1.37	25	114500224
11450B	125	36	22	1.37	25	114500236
11450B	125	60	22	1.37	25	114500260
11450B	125	120	22	1.37	25	114500320

	Ø mm	P mm	F mm	CHF		
11450C	180	24	22	2.11	25	114500424
11450C	180	36	22	2.11	25	114500436
11450C	180	60	22	1.99	25	114500460
11450C	180	120	22	1.99	25	114500520

11488PF

Plateau de fixation pour disques fibrés avec écrou M14



	∅ mm	CHF		
11488P	115	9.45	1	114880115
11488P	125	10.30	1	114880125
11488P	180	15.80	1	114880180

11491-11493-11495

Rouleau de toile abrasif

h 38 mm x 50 m



	H mm	L m	P	CHF		
11491	38	50	40	60.50	1	114910004
11491	38	50	60	59.50	1	114910006
11491	38	50	80	58.00	1	114910008
11491	38	50	100	57.00	1	114910010
11491	38	50	120	57.00	1	114910012
11491	38	50	150	57.00	1	114910015
11491	38	50	180	57.00	1	114910018
11491	38	50	220	57.00	1	114910022
11491	38	50	240	57.00	1	114910024
11491	38	50	320	57.00	1	114910032
11491	38	50	400	57.00	1	114910040

	H mm	L m	P	CHF		
11493	50	50	40	96.50	1	114930004
11493	50	50	60	88.00	1	114930006
11493	50	50	80	87.00	1	114930008
11493	50	50	100	82.00	1	114930010
11493	50	50	120	82.00	1	114930012
11493	50	50	150	82.00	1	114930015
11493	50	50	180	82.00	1	114930018
11493	50	50	220	82.00	1	114930022
11493	50	50	240	82.00	1	114930024
11493	50	50	320	82.00	1	114930032
11493	50	50	400	82.00	1	114930040

	H mm	L m	P	CHF		
11495	120	25	40	114.00	1	114950004
11495	120	25	60	111.00	1	114950006
11495	120	25	80	108.00	1	114950008
11495	120	25	100	105.50	1	114950010
11495	120	25	120	105.50	1	114950012
11495	120	25	180	105.50	1	114950018
11495	120	25	240	105.50	1	114950024
11495	120	25	400	105.50	1	114950040

11498

Rouleau de bande non-tissé

h 100 mm x 10 m



	H mm	L m	P	CHF		
11498	100	10	M	51.00	1	114980008
11498	100	10	F	41.00	1	114980012
11498	100	10	VF	41.00	1	114980015
* 11498	100	10	UF	44.50	1	114980018



PINCES À SERTIR POUR COSSES

		Terminaux	Dimensions de la matrice	Range (mm ²)	Utilisations
1601/PC					Pour connecteurs téléphoniques et transmission de données 4P/6P/8P
1602				0,75-6	Pour cosSES isolées, série légère
1602A				0-6	Pour cosSES isolées, modèle standard
1603				1,25-5,5	Pour cosSES non isolées, série légère
1603A				0-8	Pour cosSES fermées non isolées, modèle standard
1603B				0-8	Pour cosSES ouvertes non isolées, modèle standard
1606/2				0,14-10	Pour cosSES cylindriques
1606A				0,5-6 6-16	Pour cosSES cylindriques
1606T				0,1-10	Pour cosSES cylindriques, sertissage 4 côtés
1607				6,48 5,41 1,69	Robuste, pour câbles coaxiaux BNC RG 58, RG 59, RG 62, RG 71
1608				0,5-6	Pour cosSES isolées, avec régulateur de pression
1608A				0,75-6	Pour bornes isolées série légère
1609				0,5-2,5	Pour bornes non isolées
1609A				0,5-6	Pour bornes isolées série légère
1609B				10-120	Pour bornes non isolées



1601/PC

Pince à cliquet pour connecteurs téléphoniques et transmission de données

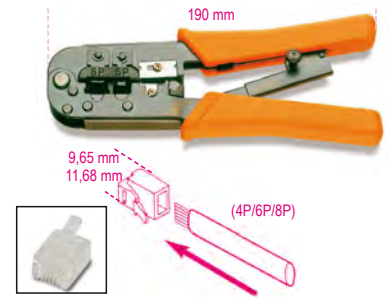

RJ11-RJ12-RJ45

CHF 82.00

2 016010011

1602

Pince à cosSES préisolées, série légère



mm²
0,75-6

CHF 20.30

5 016020001

1602/C9

Pince à cosSES préisolées série légère avec assortiment de 450 cosSES



1602/C9

CHF 177.50

1 016020045

1602

BM00180	R/6,3	50
BM00280	B/6,3	50
BM00380	G/6,3	50
BM00191	R/6,3	50
BM00291	B/6,3	50
BM00392	G/6,3	50
BM00160	R/1,6	50
BM00260	B/2,3	50
BM00360	G/3,6	50

420x350x35 mm - 1,5 kg

1602A

Pince à cosses préisolées,
modèle standard

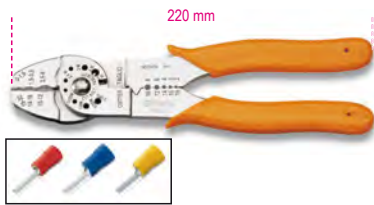

	mm ²	CHF		
	0÷6	74.50	2	016020005

1603

Pince à cosses non-isolées,
série légère

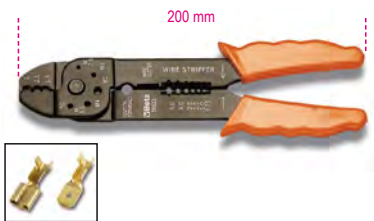

	mm ²	CHF		
	1,25÷5,5	20.30	5	016030001

1603A

Pince à cosses non-isolées fermées,
modèle standard

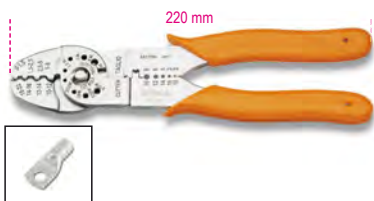

	mm ²	CHF		
	0÷8	74.50	2	016030005

1603B

Pince à cosses non-isolées ouvertes,
modèle standard

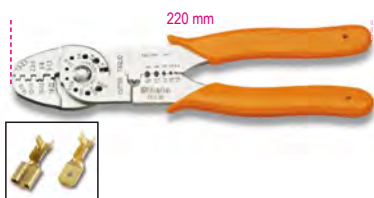

	mm ²	CHF		
	0÷8	76.00	2	016030010

1606/2

pince à cosses cylindriques,
modèle grande capacité



	mm ²	L	A	B	CHF		
	0,14÷10	175	65	20	446.00	1	016060002

1606A

Pince pour cosses tubulaires



	mm ²	CHF		
1606A6	0,5÷6	119.50	1	016060010
1606A16	6÷16	119.50	1	016060016

1606A/C9

pince pour cosses tubulaires

avec assortiment de 450 cosses



1606A/C9	CHF		
	196.50	1	016060045

1606A6	n.	
BM00601	W/0,5	50
BM00604	N/1,5	100
BM00506	B/2,5	100
BM00508	G/4	100
BM00610	Y/6	100

420x350x35 mm - 2,5 kg

Beta

1606T

Pince à sertir auto-ajustable pour cosses
cylindriques

Moindre effort de soulèvement.



	mm ²	L	A	B	CHF		
	0,1÷10	173	61	13	398.00	1	016060005

1607

Pince à cosses coaxiales,
modèle professionnel, pour connecteurs
BNC RG 58, RG 59, RG 62, RG 71



	L	A	B	CHF		
1607	220	73	19	392.00	1	016070001

1608

Pince à cosses préisolées,
avec régulateur de pression

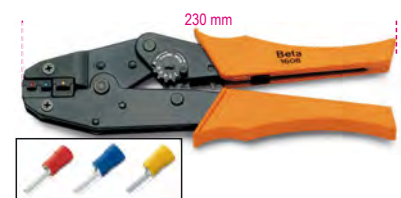

	mm ²	CHF		
	0,5÷6	153.00	1	016080001



Beta

1608/C9

Pince avec assortiment de 450 cosses



1608/C9 CHF 310.00 1 016080045

1608		n.
BM00180	R/6,3	50
BM00280	B/6,3	50
BM00380	G/6,3	50
BM00191	R/6,3	50
BM00291	B/6,3	50
BM00392	G/6,3	50
BM00160	R/1,6	50
BM00260	B/2,3	50
BM00360	G/3,6	50

420x350x35 mm - 2 kg

1608A

Pince à cosses préisolées, modèle grande capacité



mm² 0,75÷6 CHF 310.00 1 016080005

Beta

1609

Pince à cosses non-isolées automatique, modèle professionnel



mm² 0,5÷2,5 CHF 153.00 1 016090001

1609A

Pince pour cosses non-isolées, modèle grande capacité



mm² 0,5÷6 CHF 603.00 1 016090005

1609B

Pince à sertir mécanique

pour cosses non isolées de 10 à 120 mm²



L mm 600 mm² 10÷120 CHF 408.00 1 016090101

1609C/C5

Pince à sertir oléohydraulique en mallette

pour cosses non isolées de 50 à 240 mm²



mm² 50÷240 CHF 2,610.00 1 016090210

500x300x110 mm - 4 kg

1609M

Matrices pour 1609C

sertissages hexagonaux



	mm ²	CHF	
1609M/16	10-16	94.00	1 016090221
1609M/35	25-35	94.00	1 016090223
1609M/70	50-70	94.00	1 016090225
1609M/120	95-120	94.00	1 016090227
1609M/150	150	94.00	1 016090229
1609M/185	185	94.00	1 016090231
1609M/240	240	94.00	1 016090233

1639S

Sonde tire-fils en nylon

avec têtes interchangeables



L m 10 Ø mm 4 CHF 27.00 1 016390010

Beta

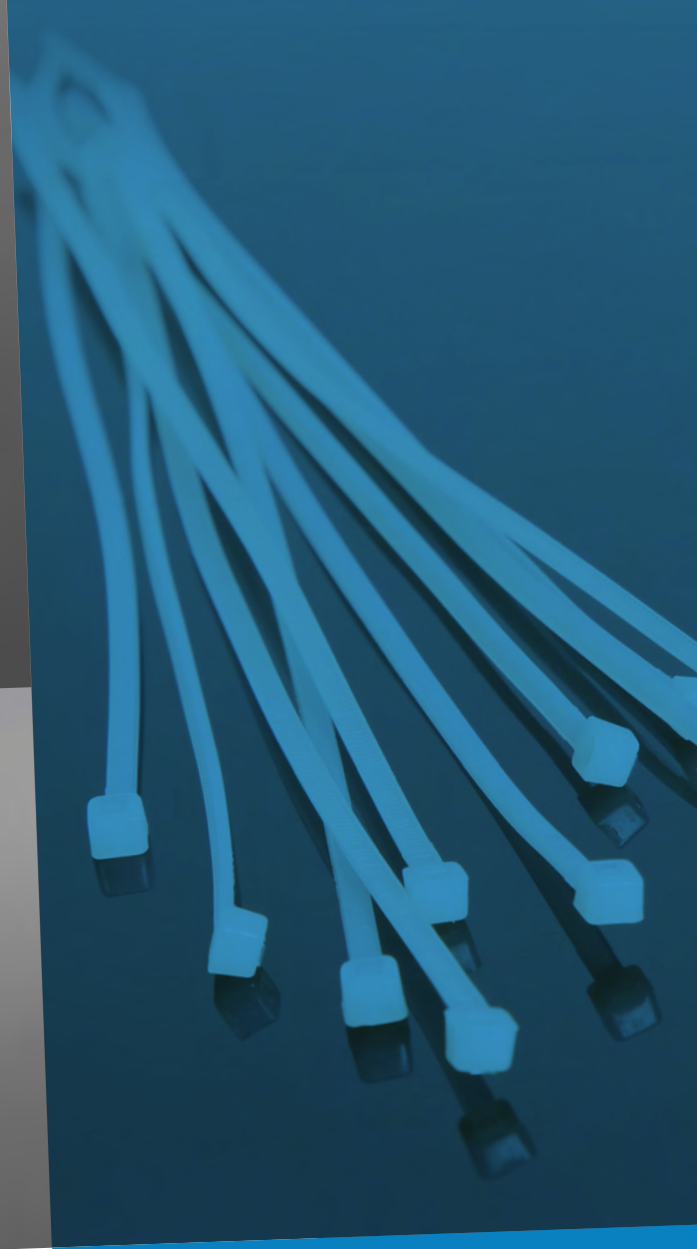
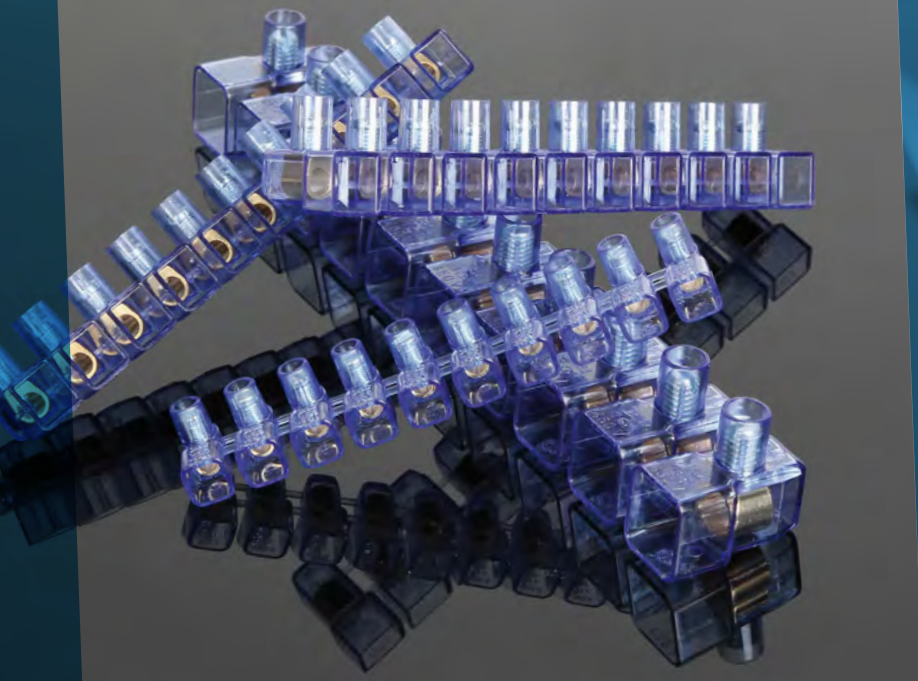

PRODUITS DE MARQUE BM : COLLIERS, BORNIERES, RUBANS ISOLANTS

Depuis 1958, BM Group conçoit, fabrique et distribue des éléments de raccord et des produits pour l'installation électrique. Qualité, sécurité et fiabilité sont depuis toujours les valeurs de BM qui, associées à la passion pour l'excellence, ont amené la société à devenir, au fur et à mesure, la référence du marché du matériel électrique.

Depuis 2018, BM Group fait partie de Beta Utensili. Une sélection attentive de produits de la marque BM est présentée dans cette section qui intègre la gamme Beta.

QUALITÉ CERTIFIÉE



1610-B

Cosse pré-isolée à œillet



D mm	mm ²	L mm	CHF	500	1000
4	0,25-1,5	20,6	10.10	100	BM00119
5	0,25-1,5	21,8	9.90	100	BM00125
5	1,5-2,5	22,4	10.10	100	BM00225
6	1,5-2,5	26	11.40	100	BM00231
8	1,5-2,5	29,8	13.50	100	BM00237
6	4-6	29,1	17.70	50	BM00331
8	4-6	34,5	21.80	50	BM00337

- Indiquer dans la commande le nombre d'embouts et non pas le nombre de boîtes
- Les prix indiqués se réfèrent à 100 pièces

1614-P

Cosse pré-isolée à embout



D mm	mm ²	L mm	CHF	500	1000
1,9	0,25-1,5	19	10.10	100	BM00151
1,9	1,5-2,5	19	10.50	100	BM00251
2,7	4-6	28	17.50	50	BM00350

- Indiquer dans la commande le nombre d'embouts et non pas le nombre de boîtes
- Les prix indiqués se réfèrent à 100 pièces

1616-SM

Cosse pré-isolée à fiche mâle

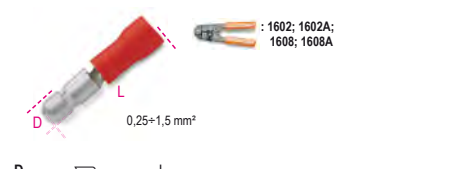

D mm	mm ²	L mm	CHF	500	1000
4	0,25-1,5	21	19.70	100	BM00130

- Indiquer dans la commande le nombre d'embouts et non pas le nombre de boîtes
- Les prix indiqués se réfèrent à 100 pièces

1618-SF

Cosse pré-isolée à fiche femelle



D mm	mm ²	L mm	CHF	500	1000
3,8	0,25-1,5	23,5	22.90	100	BM00140

- Indiquer dans la commande le nombre d'embouts et non pas le nombre de boîtes
- Les prix indiqués se réfèrent à 100 pièces

1620-M

Cosse pré-isolée rapide mâle

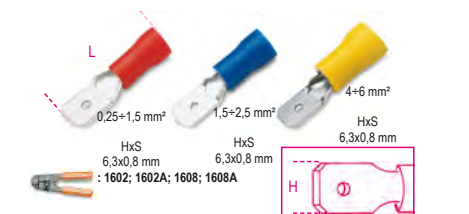

HxS mm	mm ²	L mm	CHF	500	1000
6,3x0,8	0,25-1,5	21	19.00	100	BM00180
6,3x0,8	1,5-2,5	21	19.70	100	BM00280
6,3x0,8	4-6	24,5	21.60	50	BM00380

- Indiquer dans la commande le nombre d'embouts et non pas le nombre de boîtes
- Les prix indiqués se réfèrent à 100 pièces

1622-F

Cosse pré-isolée rapide femelle

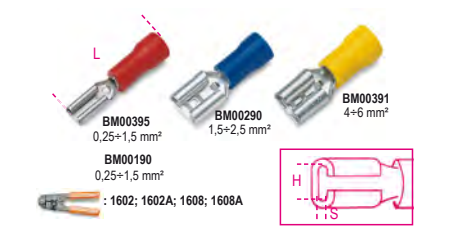

HxS mm	mm ²	L mm	CHF	500	1000
6,3x0,8	0,25-1,5	20,7	19.40	100	BM00190
2,8x0,5	0,25-1,5	18,5	16.30	100	BM00395
6,3x0,8	1,5-2,5	20,7	19.70	100	BM00290
6,3x0,8	4-6	24,5	28.00	50	BM00391

- Indiquer dans la commande le nombre d'embouts et non pas le nombre de boîtes
- Les prix indiqués se réfèrent à 100 pièces

1624-FI

Cosse rapide femelle isolée



HxS mm	mm ²	L mm	CHF	500	1000
6,3x0,8	0,25-1,5	22	21.30	100	BM00191
6,3x0,8	1,5-2,5	22	21.70	50	BM00291
6,3x0,8	4-6	25	27.00	50	BM00392

- Indiquer dans la commande le nombre d'embouts et non pas le nombre de boîtes
- Les prix indiqués se réfèrent à 100 pièces

1628-C

Connecteur de ligne pré-isolé

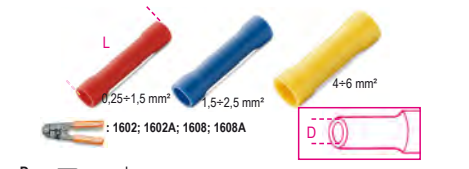

D mm	mm ²	L mm	CHF	500	1000
1,8	0,25-1,5	25	16.10	100	BM00160
2,5	1,5-2,5	26,5	19.00	100	BM00260
3,7	4-6	27	26.00	50	BM00360

- Indiquer dans la commande le nombre d'embouts et non pas le nombre de boîtes
- Les prix indiqués se réfèrent à 100 pièces

1630-CR

Connecteur rapide



mm ²	L mm	CHF	500	1000
0,25-1	15,3	16.60	500	BM00110
1,25-2,5	15,9	16.10	500	BM00210

- Indiquer dans la commande le nombre d'embouts et non pas le nombre de boîtes
- Les prix indiqués se réfèrent à 100 pièces

1632-TS

Cosse tubulaire simple



mm ²	L mm	CHF	500	1000
0,5	14	2.00	500	BM00601
0,75	14	2.00	500	BM00602
1	14	2.00	500	BM00603
1,5	14	2.00	500	BM00604
2,5	14	2.61	250	BM00506
4	17	4.15	200	BM00508
6	20	6.70	100	BM00610
0,5	14	2.00	500	BM00501
0,75	14	2.00	500	BM00502
1	14	2.00	500	BM00503
1,5	14	1.99	500	BM00504
6	20	6.70	100	BM00510

- Indiquer dans la commande le nombre d'embouts et non pas le nombre de boîtes
- Les prix indiqués se réfèrent à 100 pièces

1634-TD

Cosse tubulaire double



mm ²	L mm	CHF	500	1000
2x0,5	15	6.60	200	BM00651
2x0,75	15	5.10	200	BM00652
2x1	15	5.10	200	BM00654
2x1,5	16	5.45	200	BM00656
2x2,5	18,5	6.20	100	BM00558
2x4	23	18.50	100	BM00560
2x6	26	24.10	50	BM00661
2X0,5	15	6.60	200	BM00551
2X0,75	15	5.15	200	BM00552
2X1	15	5.15	200	BM00554
2X1,5	16	5.45	200	BM00556
2X6	26	24.10	50	BM00561

- Indiquer dans la commande le nombre d'embouts et non pas le nombre de boîtes
- Les prix indiqués se réfèrent à 100 pièces





1635-D

Bornes multiples en polypropylène, barrettes 12 pôles

Corps isolant : polypropylène (PP) naturel
Corps conducteur : cuivre
Vis imperdable : acier galvanisé
Autoextinguibilité : EN 60335-1: 2002+A2:2006 (par. 30.2.3), EN 60695-2-10 à 850 °C, EN 60695-2-11
Température de fonctionnement : max. 85 °C
Indice de protection : IP20
Normes de référence : EN 60998-1: 2004, EN 60998-2-1: 2004, EN 60335-1: 2002 + A2: 2006 (par. 30.2.3), IEC/EN 60695-2-11



mm ²	L mm	L1 mm	mm ²	CHF	🔧	📦
16	93,7	14,7	2,5	1.69	50	BM9200
20,5	116,5	17,2	4	2.10	50	BM9201
23,5	139,5	20,1	6	3.05	50	BM9202
25,3	175,5	22,5	16	5.40	25	BM9203
35,2	228	33,5	25	14.80	10	BM9204

1635-S

Borne terminale pour connexions volants

Corps isolant : polycarbonate transparent UL94 V0
Corps conducteur : cuivre
Vis imperdable : acier galvanisé
Autoextinguibilité : EN60695-2-10 à 850 °C, EN 60335-1:2002 + A2:2006, EN60695-2-11
Température de température : max. 85 °C
Indice de protection : IP20
Normes de référence : EN60998-1: EN60998-2-1:2004



mm ²	L mm	L1 mm	S mm	mm ²	N	CHF	🔧	📦
1.5	15	7.5	14.5	1.5	2	1.53	10	BM991
				1 2+3				
				0.75 2+4				
2.5	17.5	9	18.2	2.5	2	1.57	10	BM992
				1.5 2+3				
				1 2+4				
4	21	10.3	20	4	2	2.10	10	BM9924
				2.5 2+3				
				1.5 2+4				
6	22.5	11.8	23	6	2	2.44	10	BM993
				4 2+3				
				2.5 2+4				
10	26	14.7	26	10	2	4.10	10	BM994
				6 2+3				
				4 2+4				
16	31.8	18.8	32.2	16	2	9.80	10	BM995
				10 2+3				
				6 2+4				

1635-S



mm ²	L mm	L1 mm	S mm	mm ²	N	CHF	🔧	📦
25	36.3	22.5	41.9	25	2	4.55	25	BM9960
				16 2+3				
				10 2+4				
35	43.5	26.1	49.4	35	2	5.85	25	BM9961
				25 2+3				
				16 2+4				



1748-BV2

Collier en nylon, couleur naturelle

Matériel : Polyamide PA 6.6
Classe d'autoextinguibilité : UL 94-V2
Température de fonctionnement : -40 °C ÷ +85 °C
Température minimum d'installation : -10 °C
Résistance aux agents chimiques : Bonne résistance aux bases, aux huiles, aux graisses, aux solvants de chlorure.
Résistance aux acides limitée. Non résistant aux phénols
Normes de référence : EN 62275:2015-02
Classification : type 1 (EN) ; type 21 (UL)



A mm	L mm	Ø MAX mm	F MAX N	CHF	🔧	📦
2.5	80	14	80	1.59	100	BMB0824
2.5	100	20.5	80	1.48	100	BMB1025
2.5	120	27	80	2.60	100	BMB1225
2.5	160	40	80	3.50	100	BMB1625
2.5	200	52.5	80	3.85	100	BMB2025
3.6	140	33	180	3.90	100	BMB1436
3.6	200	52.5	180	5.40	100	BMB2036
3.6	300	106	180	7.65	100	BMB2936
3.6	370	105	180	12.00	100	BMB3736
4.6	120	24	220	5.25	100	BMB1248
4.6	160	36	220	5.65	100	BMB1648
4.8	188	46	220	6.75	100	BMB1948
4.8	200	50	220	6.65	100	BMB2048
4.8	250	65	220	9.60	100	BMB2548
4.8	300	81	220	9.85	100	BMB3048
4.8	370	103.5	220	12.50	100	BMB3748
4.8	390	110	220	17.00	100	BMB3948
4.8	430	122.5	220	22.00	100	BMB4348
4.8	530	160	220	36.50	100	BMB5348
7.6	150	24	550	18.10	100	BMB1576
7.6	200	51	550	18.70	100	BMB2076
7.6	300	83	550	20.80	100	BMB2976
7.6	370	103.5	550	25.50	100	BMB3776
7.6	450	130.5	550	42.50	100	BMB4576
7.6	540	159	550	55.00	100	BMB5476
7.6	750	226	550	88.00	100	BMB7576
8.8	550	163.5	800	52.00	100	BMB5390
8.8	710	195	800	73.00	100	BMB7190
8.8	780	235.5	800	82.00	100	BMB7890
9.0	430	130.5	800	43.50	100	BMB4390
9.0	810	245	800	97.50	100	BMB8190
9.0	1020	295	800	134.00	100	BMB1090
9.0	1220	375.5	800	174.00	100	BMB1290
9.0	1530	460	800	238.00	100	BMB1590

- Indiquer dans la commande le nombre de colliers et non pas le nombre de boîtes
- Les prix indiqués se réfèrent à 100 pièces



1748V

Collier en nylon, couleur vert

Matériau : Polyamide PA 6.6
Classe d'autoextinguibilité : UL 94-V2
Température de fonctionnement : -40 °C ÷ +85 °C
Température minimum d'installation : -10 °C
Résistance aux agents chimiques : Bonne résistance aux bases, aux huiles, aux graisses, aux solvants de chlorure.
Résistance aux acides limitée. Non résistant aux phénols
Normes de référence : EN 62275:2015-02
Classification : type 1 (EN); type 21 (UL)



A mm	L mm	Ø MAX mm	F MAX N	CHF	🔧	📦
2.5	100	20.5	80	1.49	100	BMV1025
3.6	140	33	180	3.90	100	BMV1436
4.8	200	50	220	6.65	100	BMV2048
4.8	300	81	220	9.85	100	BMV3048

- Indiquer dans la commande le nombre de colliers et non pas le nombre de boîtes
- Les prix indiqués se réfèrent à 100 pièces

1748N

Collier en nylon, couleur noir résistant aux UV

Matériel : Polyamide PA 6.6 + carbon black
Classe d'autoextinguibilité : UL 94-V2
Température de fonctionnement : -40 °C ÷ +85 °C
Température minimum d'installation : -10 °C
Résistance aux agents chimiques : Bonne résistance aux bases, aux huiles, aux graisses, aux solvants de chlorure.
Résistance aux acides limitée. Non résistant aux phénols
Normes de référence : EN 62275:2015-02
Classification : type 1 (EN)



A mm	L mm	Ø mm	F MAX N	CHF	🔧	📦
2.5	80	14	80	1.59	100	BMN0824
2.5	100	20.5	80	1.48	100	BMN1025
2.5	120	27	80	2.63	100	BMN1225
2.5	160	40	80	3.50	100	BMN1625
2.5	200	52.5	80	3.85	100	BMN2025
3.6	140	33	180	3.90	100	BMN1436
3.6	200	52.5	180	5.40	100	BMN2036
3.6	300	106	180	7.65	100	BMN2936
3.6	370	105	180	12.30	100	BMN3736
4.6	120	24	220	5.25	100	BMN1248
4.6	160	36	220	5.75	100	BMN1648
4.8	188	46	220	6.80	100	BMN1948
4.8	200	50	220	6.65	100	BMN2048
4.8	250	65	220	9.60	100	BMN2548
4.8	300	81	220	9.85	100	BMN3048
4.8	370	103.5	220	12.50	100	BMN3748
4.8	390	110	220	17.00	100	BMN3948
4.8	430	122.5	220	22.00	100	BMN4348
4.8	530	160	220	36.50	100	BMN5348
7.6	150	24	550	18.10	100	BMN1576
7.6	200	51	550	18.70	100	BMN2076
7.6	300	83	550	20.80	100	BMN2976
7.6	370	103.5	550	24.80	100	BMN3776
7.6	450	130.5	550	42.50	100	BMN4576
7.6	540	159	550	55.00	100	BMN5476
7.6	750	226	550	88.00	100	BMN7576
8.8	550	163.5	800	52.00	100	BMN5390
8.8	710	195	800	73.00	100	BMN7190
8.8	780	235.5	800	82.00	100	BMN7890
9.0	430	130.5	800	43.50	100	BMN4390
9.0	810	245	800	96.50	100	BMN8190
9.0	1020	295	800	134.50	100	BMN1090
9.0	1220	375.5	800	174.00	100	BMN1290
9.0	1530	460	800	238.00	100	BMN1590

- Indiquer dans la commande le nombre de colliers et non pas le nombre de boîtes
- Les prix indiqués se réfèrent à 100 pièces

1748-UL

Collier en nylon pour charges lourdes, couleur noir, résistant aux UV et aux chocs

Matériel : Polyamide PA 6.6 + carbon black
Classe d'autoextinguibilité : UL 94-V2
Température de fonctionnement : -40 °C ÷ +85 °C
Température minimum d'installation : -10 °C
Résistance aux agents chimiques : Bonne résistance aux bases, aux huiles, aux graisses, aux solvants de chlorure.
Résistance aux acides limitée. Non résistant aux phénols.
Normes de référence : EN 62275:2015-02
Classification : type 1 (EN); type 21 (UL)

CE



A	L	Ø MAX	F MAX	CHF		
mm	mm	mm	N			
12.4	230	57	1200	53.50	100	BMN2412
12.4	480	136.5	1200	92.50	100	BMN4912
12.4	730	216.1	1200	128.50	100	BMN7412
12.4	880	263.9	1200	153.50	100	BMN8912
12.4	1000	305	1200	183.50	100	BMN1012

- Indiquer dans la commande le nombre des collier et non pas le nombre de boîtes
- Les prix indiqués se réfèrent à 100 pièces

1748-N2D

Collier en nylon, couleur noir, résistant aux UV

Matériel : Polyamide PA 6.6 + carbon black
Classe d'autoextinguibilité : UL 94-V2
Température de fonctionnement : -40 °C ÷ +85 °C
Température minimum d'installation : -10 °C
Résistance aux agents chimiques : Bonne résistance aux bases, aux huiles, aux graisses, aux solvants de chlorure.
Résistance aux acides limitée. Non résistant aux phénols.
Normes de référence : EN 62275:2015-02
Classification : type 1 (EN)

CE



A	L	Ø MAX	F MAX	CHF		
mm	mm	mm	N			
9.0	180	40	400	28.00	100	BMN1890
9.0	265	62	540	42.50	100	BMN2690
9.0	360	93	540	52.00	100	BMN3690

- Indiquer dans la commande le nombre des collier et non pas le nombre de boîtes
- Les prix indiqués se réfèrent à 100 pièces



1748-BV0

Collier en nylon autoextinguible, couleur blanche

Matériel : Polyamide PA 6.6 + carbon black
Classe d'autoextinguibilité : UL 94-V0
Température de fonctionnement : -40 °C ÷ +85 °C
Température minimum d'installation : -10 °C
Résistance aux agents chimiques : Bonne résistance aux bases, aux huiles, aux graisses, aux solvants de chlorure.
Résistance aux acides limitée. Non résistant aux phénols.
Normes de référence : EN 62275:2015-02
Classification : type 1 (EN)

CE V0



A	L	Ø MAX	F MAX	CHF		
mm	mm	mm	N			
2.5	100	20.5	80	2.31	100	BMB1025V0
3.6	150	36.0	180	5.60	100	BMB1536V0
3.6	200	52.5	180	8.00	100	BMB2036V0
4.8	200	49.5	230	8.75	100	BMB2048V0
4.8	300	81.0	230	12.80	100	BMB3048V0
4.8	370	106.7	230	18.20	100	BMB3848V0
7.6	370	106.7	540	32.00	100	BMB3876V0

- Indiquer dans la commande le nombre de colliers et non pas le nombre de boîtes
- Les prix indiqués se réfèrent à 100 pièces

1748-BX

Collier en nylon, couleur bleue, détectable par les détecteurs de métaux

Matériel : Polyamide PA 6.6 + poudre métallique
Classe d'autoextinguibilité : UL 94-V2
Température de fonctionnement : -40 °C ÷ +85 °C
Température minimum d'installation : -10 °C
Résistance aux agents chimiques : Bonne résistance aux bases, aux huiles, aux graisses, aux solvants de chlorure.
Résistance aux acides limitée. Non résistant aux phénols.
Normes de référence : EN 62275:2015-02
Classification : type 1 (EN)

CE

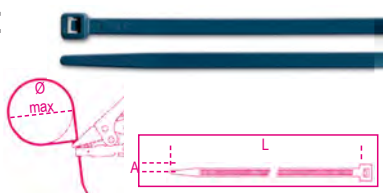

A	L	Ø MAX	F MAX	CHF		
mm	mm	mm	N			
2.5	100	20.5	80	2.78	100	BMBX1025
3.6	150	36.0	180	7.25	100	BMBX1536
3.6	200	52.5	180	9.80	100	BMBX2036
4.8	200	49.5	230	12.00	100	BMBX2048
4.8	300	81.0	230	17.40	100	BMBX3048
4.8	370	106.7	230	23.60	100	BMBX3848
7.6	370	106.7	540	42.50	100	BMBX3876

1748-BL

Collier en nylon avec dent en acier, couleur naturelle

Matériel : Polyamide PA 6.6 + acier
Classe d'autoextinguibilité : UL 94-V2
Température de fonctionnement : -40 °C ÷ +85 °C
Température minimum d'installation : -10 °C
Résistance aux agents chimiques : Bonne résistance aux bases, aux huiles, aux graisses, aux solvants de chlorure.
Résistance aux acides limitée. Non résistant aux phénols.
Normes de référence : EN 62275:2015-02
Classification : type 1 (EN)

CE

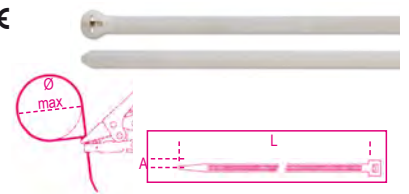

A	L	Ø MAX	F MAX	CHF		
mm	mm	mm	N			
2.5	100	20.5	180	5.50	100	BMBL1025
2.5	200	52.5	180	7.20	100	BMBL2025
3.6	140	33.0	250	12.40	100	BMBL1436
4.8	200	49.5	360	17.20	100	BMBL2048
4.8	300	81.0	360	22.10	100	BMBL3048
4.8	370	103.5	360	26.50	100	BMBL3748
7.6	370	103.5	780	50.00	100	BMBL3776

- Indiquer dans la commande le nombre de colliers et non pas le nombre de boîtes
- Les prix indiqués se réfèrent à 100 pièces

1748-NL

Collier en nylon avec dent en acier, couleur noir, résistant aux UV

Matériel : Polyamide PA 6.6 + acier + carbon black
Classe d'autoextinguibilité : UL 94-V2
Température de fonctionnement : -40 °C ÷ +85 °C
Température minimum d'installation : -10 °C
Résistance aux agents chimiques : Bonne résistance aux bases, aux huiles, aux graisses, aux solvants de chlorure.
Résistance aux acides limitée. Non résistant aux phénols.
Normes de référence : EN 62275:2015-02
Classification : type 1 (EN)

CE

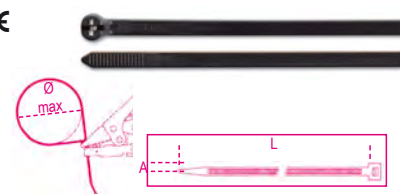

A	L	Ø MAX	F MAX	CHF		
mm	mm	mm	N			
2.5	100	20.5	180	5.50	100	BMNL1025
2.5	200	52.5	180	7.20	100	BMNL2025
3.6	140	33.0	250	12.40	100	BMNL1436
4.8	200	49.5	360	17.20	100	BMNL2048
4.8	300	81.0	360	22.10	100	BMNL3048
4.8	370	103.5	360	26.50	100	BMNL3748
7.6	370	103.5	780	49.00	100	BMNL3776

- Indiquer dans la commande le nombre de colliers et non pas le nombre de boîtes
- Les prix indiqués se réfèrent à 100 pièces



1748-BR

Collier en nylon réutilisable,
couleur naturelle

Matériel : Polyamide PA 6.6
Classe d'autoextinguibilité : UL 94-V2
Température de fonctionnement : -40 °C ÷ +85 °C
Température minimum d'installation : -10 °C
Résistance aux agents chimiques : Bonne résistance aux bases, aux huiles, aux graisses, aux solvants de chlorure. Résistance aux acides limitée. Non résistant aux phénols
Normes de référence : EN 62275:2015-02
Classification: type 1 (EN) ; type 21 (UL)

CE

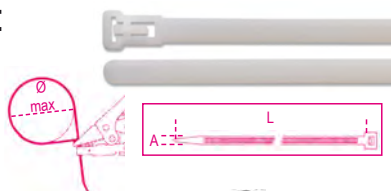

UL FILE N° E223175

A	L	Ø MAX	F MAX	CHF		
mm	mm	mm	N			
7.6	150	40	230	19.10	100	BMBR1576
7.6	200	55	230	20.50	100	BMBR2076
7.6	300	82	230	34.50	100	BMBR3076

- Indiquer dans la commande le nombre de colliers et non pas le nombre de boîtes
- Les prix indiqués se réfèrent à 100 pièces

1748-BH

Collier en nylon avec œillet,
couleur naturelle

Matériel : Polyamide PA 6.6
Classe d'autoextinguibilité : UL 94-V2
Température de fonctionnement : -40 °C ÷ +85 °C
Température minimum d'installation : -10 °C
Résistance aux agents chimiques : Bonne résistance aux bases, aux huiles, aux graisses, aux solvants de chlorure. Résistance aux acides limitée. Non résistant aux phénols
Normes de référence : EN 62275:2015-02
Classification: type 1 (EN) ; type 21 (UL)

CE

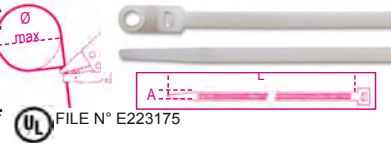

UL FILE N° E223175

A	L	Ø MAX	F MAX	CHF		
mm	mm	mm	N			
2.5	110	19.0	80	5.10	100	BMBH1125
* 4.8	200	49.8	230	12.50	100	BMBH2048
* 7.6	305	78.7	550	41.00	100	BMBH3076

- Indiquer dans la commande le nombre de colliers et non pas le nombre de boîtes
- Les prix indiqués se réfèrent à 100 pièces



1748-BP

Collier en nylon à insertion,
couleur naturelle

Matériel : Polyamide PA 6.6
Classe d'autoextinguibilité : UL 94-V2
Température de fonctionnement : -40 °C ÷ +85 °C
Température minimum d'installation : -10 °C
Résistance aux agents chimiques : Bonne résistance aux bases, aux huiles, aux graisses, aux solvants de chlorure. Résistance aux acides limitée. Non résistant aux phénols
Normes de référence : EN 62275:2015-02
Classification: type 1 (EN) ; type 21 (UL)

CE

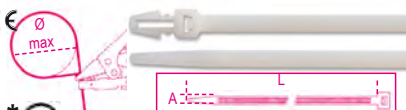

UL FILE N° E223175

A	L	Ø MAX	F MAX	CHF		
mm	mm	mm	N			
3.6	155	37.9	180	7.75	100	BMBP1536
* 4.8	200	50.8	230	13.40	100	BMBP2048

- Indiquer dans la commande le nombre de colliers et non pas le nombre de boîtes
- Les prix indiqués se réfèrent à 100 pièces

1748-BT

Collier en nylon avec plaque transversale 25x8 mm,
couleur naturelle

Matériel : Polyamide PA 6.6
Classe d'autoextinguibilité : UL 94-V2
Température de fonctionnement : -40 °C ÷ +85 °C
Température minimum d'installation : -10 °C
Résistance aux agents chimiques : Bonne résistance aux bases, aux huiles, aux graisses, aux solvants de chlorure. Résistance aux acides limitée. Non résistant aux phénols
Normes de référence : EN 62275:2015-02
Classification: type 1 (EN) ; type 21 (UL)

CE

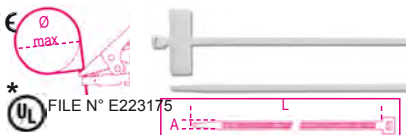

UL FILE N° E223175

A	L	Ø MAX	F MAX	CHF		
mm	mm	mm	N			
2.5	100	22.0	80	8.70	100	BMBT21025
2.5	200	53.5	80	13.60	100	BMBT22025

- Indiquer dans la commande le nombre de colliers et non pas le nombre de boîtes
- Les prix indiqués se réfèrent à 100 pièces

1748-BT2

Collier en nylon avec plaque longitudinale 13x27 mm,
couleur naturelle

Matériel : Polyamide PA 6.6
Classe d'autoextinguibilité : UL 94-V2
Température de fonctionnement : -40 °C ÷ +85 °C
Température minimum d'installation : -10 °C
Résistance aux agents chimiques : Bonne résistance aux bases, aux huiles, aux graisses, aux solvants de chlorure. Résistance aux acides limitée. Non résistant aux phénols
Normes de référence : EN 62275:2015-02
Classification: type 1 (EN)

CE



A	L	Ø MAX	F MAX	CHF		
mm	mm	mm	N			
4.8	190	51	230	16.10	100	BMBT12248

- Indiquer dans la commande le nombre de colliers et non pas le nombre de boîtes
- Les prix indiqués se réfèrent à 100 pièces

1748-BT3

Collier en nylon avec plaque externe 20x9 mm,
couleur naturelle

Matériel : Polyamide PA 6.6
Classe d'autoextinguibilité : UL 94-V2
Température de fonctionnement : -40 °C ÷ +85 °C
Température minimum d'installation : -10 °C
Résistance aux agents chimiques : Bonne résistance aux bases, aux huiles, aux graisses, aux solvants de chlorure. Résistance aux acides limitée. Non résistant aux phénols
Normes de référence : EN 62275:2015-02
Classification: type 1 (EN)

CE

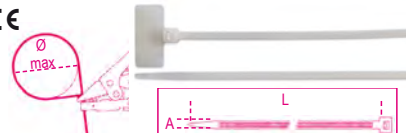

A	L	Ø MAX	F MAX	CHF		
mm	mm	mm	N			
2.5	110	22	80	8.85	100	BMBT11125

- Indiquer dans la commande le nombre de colliers et non pas le nombre de boîtes
- Les prix indiqués se réfèrent à 100 pièces

1748-BA1

Embase de fixation

Matériel : Polyamide PA 6.6
Classe d'autoextinguibilité : UL 94-V2
Température de fonctionnement : -40 °C ÷ +85 °C
Température minimum d'installation : -10 °C
Résistance aux agents chimiques : Bonne résistance aux bases, aux huiles, aux graisses, aux solvants de chlorure. Résistance aux acides limitée. Non résistant aux phénols

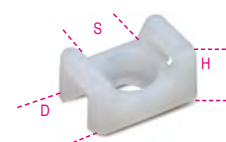

SxDxH	Ø	F	CHF		
mm	mm	mm			
15.2x9.4x6.8	3.3	3.6	12.00	100	BMB0905
22x16.2x10.8	5.2	9	27.00	100	BMB0906

- Indiquer dans la commande le nombre de colliers et non pas le nombre de boîtes
- Les prix indiqués se réfèrent à 100 pièces

1748-NA1

Embase de fixation

Matériel : Polyamide PA 6.6
Classe d'autoextinguibilité : UL 94-V2
Température de fonctionnement : -40 °C ÷ +85 °C
Température minimum d'installation : -10 °C
Résistance aux agents chimiques : Bonne résistance aux bases, aux huiles, aux graisses, aux solvants de chlorure. Résistance aux acides limitée. Non résistant aux phénols



SxDxH	Ø	F	CHF		
mm	mm	mm			
15.2x9.4x6.8	3.3	3.6	12.40	100	BMN0905
22x16.2x10.8	5.2	9	22.10	100	BMN0906

- Indiquer dans la commande le nombre de colliers et non pas le nombre de boîtes
- Les prix indiqués se réfèrent à 100 pièces

1748-BA2

Embase de fixation bidirectionnelle

Matériel : Polyamide PA 6.6
 Classe d'autoextinguibilité : UL 94-V2
 Température de fonctionnement : -40 °C ÷ +85 °C
 Température minimum d'installation : -10 °C
 Résistance aux agents chimiques : Bonne résistance aux bases, aux huiles, aux graisses, aux solvants de chlorure.
 Résistance aux acides limitée. Non résistant aux phénols

CE

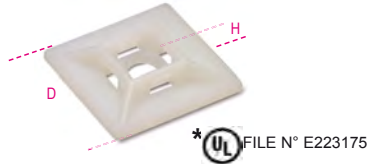

SxDxH mm	F mm	CHF		
19x19x5.4	3.6	15.00	100	BMB0901
* 28x28x7	4.8	20.70	100	BMB0902
* 28x28x5.8	4.8	19.00	100	BMB0903

- Indiquer dans la commande le nombre de colliers et non pas le nombre de boîtes
- Les prix indiqués se réfèrent à 100 pièces

1748-NA2

Embase de fixation bidirectionnelle, résistante aux UV

Matériel : Polyamide PA 6.6
 Classe d'autoextinguibilité : UL 94-V2
 Température de fonctionnement : -40 °C ÷ +85 °C
 Température minimum d'installation : -10 °C
 Résistance aux agents chimiques : Bonne résistance aux bases, aux huiles, aux graisses, aux solvants de chlorure.
 Résistance aux acides limitée. Non résistant aux phénols

CE



SxDxH mm	F mm	CHF		
19x19x5.4	3.6	15.00	100	BMN0901
* 28x28x7	4.8	20.70	100	BMN0902
* 28x28x5.8	4.8	18.90	100	BMN0903

- Indiquer dans la commande le nombre de colliers et non pas le nombre de boîtes
- Les prix indiqués se réfèrent à 100 pièces

1748-S

Collier autobloquant en acier inoxydable

Matériel : acier inox AISI 304 + polyester
 Dispositif de fixation : à billes
 Classe d'autoextinguibilité : non inflammable
 Plenum rating : AH-1
 Résistance aux rayons UV : excellente
 Température de fonctionnement : -60 °C ÷ +300 °C
 Température minimum d'installation : -60 °C
 Résistance aux agents chimiques : excellente
 Normes de référence : EN 62275:2015-02
 Classification : type 2 (EN) ; type 2 (UL)

CE

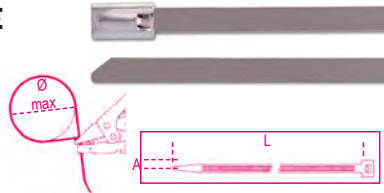

A mm	L mm	ØMAX mm	Trazione N	CHF		
4.6	125	38	890	91.00	100	BMS1345
4.6	200	61.9	890	95.00	100	BMS2045
7.9	200	61.9	1500	100.50	100	BMS2079
4.6	290	90.6	890	102.50	100	BMS3045
7.9	300	90.6	1500	116.00	100	BMS3079
4.6	360	112.8	890	111.00	100	BMS3745
7.9	360	112.8	1500	126.50	100	BMS3779
7.9	520	163.8	1500	150.00	100	BMS5079
4.6	520	163.8	890	111.00	100	BMS5245
4.6	680	214.8	890	118.00	100	BMS6845
7.9	680	214.8	1500	170.50	100	BMS6879
4.6	840	265.7	890	123.50	100	BMS8445
7.9	840	265.7	1500	202.00	100	BMS8479

- Indiquer dans la commande le nombre de colliers et non pas le nombre de boîtes
- Les prix indiqués se réfèrent à 100 pièces

1748-SC

Collier autobloquant en acier inoxydable, revêtement en polyester noir

Matériel : acier inox AISI 304 + polyester
 Dispositif de fixation : à billes
 Classe d'autoextinguibilité : non inflammable
 Plenum rating : AH-1
 Résistance aux rayons UV : excellente
 Température de fonctionnement : -60 °C ÷ +300 °C
 Température minimum d'installation : -60 °C
 Résistance aux agents chimiques : excellente
 Normes de référence : EN 62275:2015-02
 Classification : type 2 (EN) ; type 2 (UL)

CE

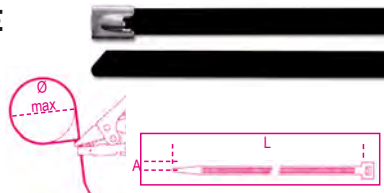

A mm	L mm	ØMAX mm	Trazione N	CHF		
4.6	125	38	450	95.00	100	BMSC1345
4.6	200	61.9	450	110.50	100	BMSC2045
7.9	200	61.9	800	112.00	100	BMSC2079
4.6	290	90.6	450	123.50	100	BMSC3045
7.9	300	90.6	800	132.00	100	BMSC3079
4.6	360	112.8	450	136.50	100	BMSC3745
7.9	360	112.8	800	149.00	100	BMSC3779
7.9	520	163.8	800	186.50	100	BMSC5079
4.6	520	163.8	450	138.00	100	BMSC5245
4.6	680	214.8	450	157.50	100	BMSC6845
7.9	680	214.8	800	212.50	100	BMSC6879
4.6	840	265.7	450	167.50	100	BMSC8445
7.9	840	265.7	800	255.00	100	BMSC8479

- Indiquer dans la commande le nombre de colliers et non pas le nombre de boîtes
- Les prix indiqués se réfèrent à 100 pièces

1748-BV

Collier velcro, réouverture par arrachage couleur blanche

Matériau : polyéthylène-polyamide (PE-PA)
 Température de fonctionnement : -20 °C ÷ +60 °C

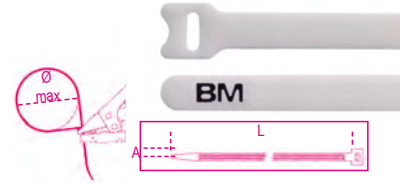

A mm	L mm	Ø MAX mm	F MAX N	CHF		
12,7	229	55	180	273.00	10	BMBV2312
19	229	55	220	314.00	10	BMBV2319

- Indiquer dans la commande le nombre de colliers et non pas le nombre de boîtes
- Les prix indiqués se réfèrent à 100 pièces

1748-NV

Collier velcro, réouverture par arrachage couleur noir

Matériau : polyéthylène-polyamide (PE-PA)
 Température de fonctionnement : -20 °C ÷ +60 °C

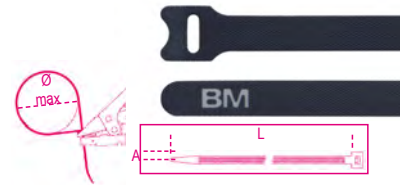

A mm	L mm	Ø MAX mm	F MAX N	CHF		
12,7	229	55	180	273.00	10	BMNV2312

- Indiquer dans la commande le nombre de colliers et non pas le nombre de boîtes
- Les prix indiqués se réfèrent à 100 pièces

1743

Pince pour colliers en Nylon

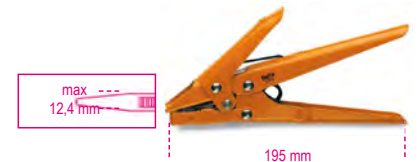

CHF		
70.50	1	017430001

1743T

Pince pour colliers

- Indiqué également pour couper de petits câbles (3x1.5mm²; 1x17mm²)



CHF		
42.00	1	017430100



1748-N

Pince pour colliers en nylon d'une largeur de 2,5 à 4,8 mm

Coupe automatique lorsque la tension programmée est atteinte.

Équipée d'un réglage de la tension de serrage

Matériau : structure en polymère et fibre de verre, pièces internes en métal.



CHF 76.00 1 BM1100

1748-N

1748-ST

Pince automatique pour colliers en acier inoxydable, pour colliers de 4,6 à 9 mm, avec contrôle automatique de la tension et coupe



CHF 293.00 1 BM1105

1748-ST

1638M

Gaine thermorétractable de faible épaisseur, en minibox

Taux de rétrécissement : 2 : 1

Matériau : polyéthylène

Température de fonctionnement : -55 °C + 125 °C

Température de rétraction : + 70 °C + 110 °C

VRMS maximal : 600V

Degré d'auto-extinction de la gaine : retardateur de flamme

VW-1 (UL 1581)

Sans halogènes



L mm	Ø1 mm	Ø2 mm	CHF	1	BM
1,6	2,0+0,-0,30,85		23.40	1	BMGBS016MNE
2,4	11 3,00+0,-31,25		23.40	1	BMGBS024MNE
3,2	11 3,5+0,-4 1,5		23.40	1	BMGBS032MNE
4,8	10 5,5+0,-4 2,5		23.40	1	BMGBS048MNE
6,4	9 6,5+0,-4 3		23.40	1	BMGBS064MNE
9,5	7 9,5+0,-5 4,5		23.40	1	BMGBS095MNE
12,7	6 13,5+0,-5 6,5		23.40	1	BMGBS127MNE
19	5 21+0,-5 10		23.90	1	BMGBS190MNE
25,4	3,5 26,0+0,-5 12,5		24.40	1	BMGBS254MNE

1639ESB

Ruban isolant en PVC

Température de fonctionnement : 0-90 °C

Charge de rupture : 28N/cm équivalent à 18,6 N/mm²

Allongement à rupture : 200 %

Adhérence à l'acier : 2.2N/cm

Adhérence sur l'arrière : 2 N/cm

Rigidité diélectrique : 45kV/mm

Inflammabilité : retardateur de flamme

Normes de référence : IEC 60454-2

Classification : CEI EN 60454-3-1-5/F-VPVCP/90



S mm	A mm	L m	CHF	10	BMESB
0.15	15	10	1.03	10	BMESB1510BI
0.15	15	10	1.03	10	BMESB1510BL
0.15	15	10	1.03	10	BMESB1510GI
0.15	15	10	1.03	10	BMESB1510GR
0.15	15	10	1.15	10	BMESB1510GV
0.15	15	10	1.03	10	BMESB1510MA
0.15	15	10	1.03	10	BMESB1510NE
0.15	15	10	1.03	10	BMESB1510RO
0.15	15	10	1.03	10	BMESB1510VE
0.15	15	25	2.51	10	BMESB1525BI
0.15	15	25	2.51	10	BMESB1525BL
0.15	15	25	2.51	10	BMESB1525GI
0.15	15	25	2.51	10	BMESB1525GR
0.15	15	25	2.62	10	BMESB1525GV
0.15	15	25	2.51	10	BMESB1525MA
0.15	15	25	2.51	10	BMESB1525NE
0.15	15	25	2.51	10	BMESB1525RO
0.15	15	25	2.51	10	BMESB1525VE
0.15	19	25	2.75	10	BMESB1925BI
0.15	19	25	2.75	10	BMESB1925BL
0.15	19	25	2.75	10	BMESB1925GI
0.15	19	25	2.75	10	BMESB1925GR
0.15	19	25	2.86	10	BMESB1925GV
0.15	19	25	2.75	10	BMESB1925MA
0.15	19	25	2.75	10	BMESB1925NE
0.15	19	25	2.75	10	BMESB1925RO
0.15	19	25	2.75	10	BMESB1925VE
0.15	25	25	3.85	8	BMESB2525BI
0.15	25	25	3.85	8	BMESB2525BL
0.15	25	25	3.85	8	BMESB2525GI
0.15	25	25	3.85	8	BMESB2525GR
0.15	25	25	3.95	8	BMESB2525GV
0.15	25	25	3.85	8	BMESB2525MA
0.15	25	25	3.85	8	BMESB2525NE
0.15	25	25	3.85	8	BMESB2525RO
0.15	25	25	3.85	8	BMESB2525VE
0.15	50	25	6.20	4	BMESB5025NE

1639ESC

Ruban isolant en PVC

Température de fonctionnement : 0-80 °C

Charge de rupture : 28N/cm équivalent à 18,6 N/mm²

Allongement à rupture : 200 %

Adhérence à l'acier : 2.2N/cm

Adhérence sur l'arrière : 2.2 N/cm

Rigidité diélectrique : 38kV/mm

Inflammabilité : retardateur de flamme

Normes de référence : ASTM-D-1000 ; UL510

Classification : CEI EN 60454-3-1-5/F-VPVCP/90



S mm 0.18 A mm 19 L m 20 CHF 3.65 10 BMESC1920NE

1639ETA

Ruban isolant en PVC pour températures extrêmes

Température de fonctionnement : -18 + 105 °C

Charge de rupture : 35N/cm équivalent à 19,4 N/mm²

Allongement à rupture : 300 %

Adhérence à l'acier : 3.1N/cm

Adhérence sur l'arrière : 2.7 N/cm

Rigidité diélectrique : 55.5kV/mm

Inflammabilité : retardateur de flamme

Normes de référence : ASTM-D-1000 ; UL510

Classification : CEI EN 60454-3-1-5/F-VPVCP/90



S mm 0.18 A mm 19 L m 20 CHF 10.90 1 BMETA1920NE

1639EAB

Ruban isolant autoagglomérant à base d'EPR

Température de fonctionnement : -40 + 90 °C

Charge de rupture : 2,4 N/mm²

Allongement à rupture : 750%

Rigidité diélectrique : 29,5kV/mm

Inflammabilité : retardateur de flamme

Normes de référence : ASTM-D-4388; ASTM-D-4325

Excellente résistance à l'humidité, à la corrosion et aux agents chimiques



S mm 0.76 A mm 19 L m 9 CHF 22.30 1 BMEAB1909NE

Beta
Quality Tools

Beta



GAMME BLISTER

pour la vente
en libre service!

- **Meilleure visibilité**
- **Efficacité d'exposition**
- **Code à barres**



SUPPORT BLISTER:

- PVC indéchirable
- 4 formats pour optimiser l'espace d'exposition
- Système de fixation de nouvelle génération avec bande élastique

42K



mm	CHF	🔧	📄
5,5x5,5	10.70	5	000429505
6x6	10.90	5	000429506
7x7	11.00	5	000429507
8x8	11.30	5	000429508
9x9	11.90	5	000429509
10x10	12.20	5	000429510
11x11	13.00	5	000429511
12x12	13.20	5	000429512
13x13	13.20	5	000429513
14x14	15.00	5	000429514
15x15	16.60	5	000429515
16x16	17.10	5	000429516
17x17	18.00	5	000429517
18x18	19.00	5	000429518
19x19	19.70	5	000429519
20x20	22.10	3	000429520
21x21	23.70	3	000429521
22x22	24.40	3	000429522
23x23	26.00	3	000429523
24x24	27.50	3	000429524
25x25	29.00	2	000429525
26x26	31.50	2	000429526
27x27	34.00	2	000429527
28x28	34.50	2	000429528
29x29	38.50	2	000429529
30x30	39.50	2	000429530
32x32	44.00	2	000429532

55K

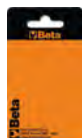

mm	CHF	🔧	📄
6x7	7.20	5	000559012
8x9	7.30	5	000559021
10x11	7.70	5	000559030
10x12	10.40	5	000559033
10x13	11.40	5	000559035
12x13	8.60	5	000559042
12x14	11.60	5	000559045
13x17	13.60	5	000559051
14x15	10.80	5	000559054
14x17	14.60	5	000559057
16x17	12.30	5	000559060
17x19	16.40	2	000559063
18x19	14.40	2	000559066
19x22	18.50	2	000559069
20x22	16.40	2	000559075
21x23	17.40	2	000559078
22x24	20.10	2	000559081
24x26	20.60	2	000559087
24x27	22.50	2	000559090
25x28	23.40	2	000559096
27x29	26.00	2	000559099
27x30	30.00	2	000559102
30x32	29.00	2	000559108

90K



mm	CHF	🔧	📄
6x7	13.30	5	000909006
8x9	14.10	5	000909012
10x11	15.60	5	000909018
12x13	17.00	5	000909027
14x15	18.50	5	000909033
16x17	21.10	5	000909039
18x19	24.70	5	000909045
20x22	28.00	3	000909051
21x23	31.50	2	000909057
24x26	35.50	2	000909063
24x27	39.00	2	000909067

mm	CHF	🔧	📄
25x28	42.50	2	000909070
27x29	46.00	2	000909073
30x32	51.50	2	000909080

93K

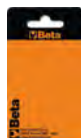

mm	CHF	🔧	📄
21x22	53.50	3	000939021

94K



mm	CHF	🔧	📄
8x10	22.90	2	000949008
9x11	23.80	2	000949009
10x11	24.90	2	000949010
11x13	25.50	2	000949011
12x14	27.00	2	000949012
13x15	27.00	2	000949013
14x15	31.50	2	000949014
14x17	33.00	2	000949015
17x19	33.50	2	000949017
19x22	35.50	2	000949019
22x24	44.00	2	000949022
24x27	47.50	2	000949024
30x32	62.00	2	000949030

96/SC9

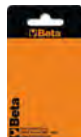

96/SC9	CHF	🔧	📄
1,5-2-2,5-3-4-5-6-8-10 mm	27.00	1	000960374

96/ST6K

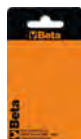

96/ST6K	CHF	🔧	📄
2,5-3-4-5-6-8 mm	19.10	3	000969370

96N/ST6K

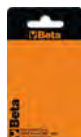

96N/ST6K	CHF	🔧	📄
2,5-3-4-5-6-8 mm	13.50	3	000969640

96BPA/SC9



96BPA/SC9	CHF	🔧	📄
1,5-2-2,5-3-4-5-6-8-10 mm	62.00	1	000961974

96BP-CL/SC9



96BP-CL/SC9	CHF	🔧	📄
1,5-2-2,5-3-4-5-6-8-10 mm	69.00	1	000961619

96BPC/SC9



96BPC/SC9	CHF	🔧	📄
1,5-2-2,5-3-4-5-6-8-10 mm	56.50	1	000960354

96C/AS



"	CHF	🔧	📄
1/16	2.22	20	000961702
3/32	3.10	20	000961706
1/8	3.25	20	000961710
5/32	3.80	20	000961714
3/16	4.30	20	000961716
7/32	4.85	20	000961718
1/4	5.40	20	000961720
5/16	6.00	10	000961724
3/8	7.45	10	000961728

96LBP/SC9



96LBP/SC9	CHF	🔧	📄
1,5-2-2,5-3-4-5-6-8-10 mm	65.50	1	000961354

96/BGS7

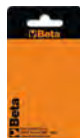

96/BGS7
1,5-2-2,5-3-4-5-6 mm
CHF 40.50 1 000960367

96/BG7



96/BG7
2,5-3-4-5-6-8-10 mm
CHF 42.50 1 000960368

96TK



mm	CHF	U	IT
2	15.60	5	000969934
2,5	15.60	5	000969935
3	16.40	5	000969936
4	16.90	5	000969938
5	17.20	5	000969940
6	19.70	5	000969941
8	24.90	3	000969943
10	28.50	3	000969945

97BTX/SC8

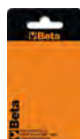

97BTX/SC8
T9-T10-T15-T20-T25-T27-T30-T40
CHF 101.00 1 000970164

97BTXL/SC8

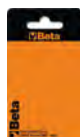

97BTXL/SC8
T9-T10-T15-T20-T25-T27-T30-T40
CHF 116.50 1 000970364

111E



L mm	CHF	U	IT
100	32.00	3	001110110
150	33.50	3	001110115
200	41.00	3	001110120
250	49.50	3	001110125
300	65.50	3	001110130
380	129.00	3	001110138
450	214.50	2	001110145
600	297.00	1	001110160

111EN



L mm	CHF	U	IT
100	29.50	3	001110410
150	31.00	3	001110415
200	36.00	3	001110420
250	44.50	3	001110425
300	60.00	3	001110430
380	119.00	3	001110438
450	202.50	2	001110445

111ER



L mm	CHF	U	IT
200	42.50	3	001110520
250	52.50	3	001110525
300	69.00	2	001110530

123/K4



123/K4
CHF 42.50 1 001230504

142K



mm	CHF	U	IT
6	23.20	3	001429006
7	23.20	3	001429007
8	23.90	3	001429008
9	25.50	3	001429009
10	26.00	3	001429010
11	27.00	3	001429011
12	28.00	3	001429012
13	30.00	3	001429013
14	31.00	2	001429014
15	33.00	2	001429015
16	35.50	2	001429016
17	36.50	2	001429017
18	39.00	2	001429018
19	39.50	2	001429019
21	51.50	1	001429021
22	53.50	1	001429022
24	62.00	1	001429024

192/S2



192/S2
8x10/12x13 mm
16x17/18x19 mm
CHF 83.00 1 001920070

195K



mm	CHF	U	IT
8x10	26.50	2	001959010
12x13	30.00	2	001959013
14x15	31.50	2	001959015
16x18	37.00	2	001959018
17x19	39.00	2	001959019

374K



L mm
240
CHF 49.00 1 003749024



850MQ



L mm	CHF	1	008550910
233	31.00	1	008550910

855P



L1 mm	CHF	1	008550010
240	94.00	1	008550010

860/58K



L mm	CHF	1	008609884
126	100.50	1	008609884

860LP



SxA mm	CHF	5	008600005
0,5x3	2.47	5	008600005
0,6x4,5	2.47	5	008600010
0,8x5,5	2.47	5	008600015
1x5,5	2.47	5	008600020
1,2x6,5	2.47	5	008600025

860PH



PH	CHF	5	008600220
0	2.47	5	008600220
1	2.47	5	008600225
2	2.47	5	008600230
3	2.47	5	008600245
4	3.60	5	008600250

860PZ



PZ	CHF	5	008600320
1	2.47	5	008600320
2	2.47	5	008600325
3	2.47	5	008600330
4	3.60	5	008600335

860PE



mm	CHF	5	008600101
2	2.63	5	008600101
2,5	2.63	5	008600102
3	2.63	5	008600103
4	2.63	5	008600104
5	2.63	5	008600105
6	2.63	5	008600106
8	3.30	5	008600108
10	3.30	5	008600110

860TX



mm	CHF	5	008600704
T6	3.30	5	008600704
T7	3.30	5	008600705
T8	3.30	5	008600710
T9	3.30	5	008600715
T10	2.63	5	008600720
T15	2.63	5	008600725
T20	2.63	5	008600730
T25	2.63	5	008600735
T27	2.63	5	008600740
T30	2.63	5	008600745
T40	2.63	5	008600750

860RTX



mm	CHF	5	008600550
T9	3.60	5	008600550
T10	3.60	5	008600555
T15	3.60	5	008600560
T20	3.60	5	008600565
T25	3.60	5	008600570
T27	3.60	5	008600575
T30	3.60	5	008600580
T40	3.60	5	008600585

860/C27



860/C27	CHF	1	008600880
860/C27	114.50	1	008600880

860MIX/A10



860MIX/A10	CHF	1	008600900
860MIX/A10	47.00	1	008600900

860TX/A10



860TX/A10	CHF	1	008600970
860TX/A10	51.00	1	008600970

860MIX/A31



860MIX/A31	CHF	1	008600902
860MIX/A31	112.00	1	008600902

862F/A7



862F/A7	CHF	1	008620950
862F/A7	65.00	1	008620950

900K



mm	CHF	10	009009040
4	5.50	10	009009040
4,5	5.50	10	009009045
5	5.50	10	009009050
5,5	5.50	10	009009055
6	5.50	10	009009060
7	5.50	10	009009070
8	5.50	10	009009080
9	5.50	10	009009090
10	5.50	10	009009100
11	5.50	10	009009110
12	5.50	10	009009120
13	5.60	10	009009130
14	5.70	10	009009140

900/20LK



L mm	CHF	5	009009819
100	12.30	5	009009819

900/25K

1/4"



L mm	CHF		
41	22.70	5	009009830

900BG/30K

1/4"



L mm	CHF		
128	11.90	5	009009834

900/55K

3/8"

1/4"



L mm	CHF		
125	60.50	5	009009870

900/55ZK

3/8"

1/4"



L mm	CHF		
125	60.50	3	009009882

900/58K

1/4"

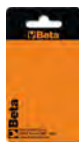

L mm	CHF		
126	92.50	2	009009884

910AK

3/8"



mm	CHF		
6	8.55	5	009109006
7	8.55	5	009109007
8	8.55	5	009109008
9	8.55	5	009109009
10	8.55	5	009109010
11	8.55	5	009109011
12	8.85	5	009109012
13	8.85	5	009109013
14	8.85	5	009109014
15	8.85	5	009109015
16	9.90	5	009109016
17	9.90	5	009109017
18	9.90	5	009109018
19	9.90	5	009109019
20	10.60	5	009109020
21	10.60	5	009109021
22	10.90	5	009109022

910/21K

3/8"



L mm	CHF		
125	15.80	5	009109822

910/25K

3/8"



L mm	CHF		
54,6	28.00	5	009109830

910/55K

7/8"

3/8"



L mm	CHF		
200	65.50	3	009109882

910/58K

3/8"



L mm	CHF		
222	101.00	1	009109884

920AK

12"



mm	CHF		
10	8.70	10	009209010
11	8.70	10	009209011
12	8.70	10	009209012
13	9.00	10	009209013
14	9.00	10	009209014
15	9.00	10	009209015
16	10.10	10	009209016
17	10.10	10	009209017
18	10.10	10	009209018
19	10.10	10	009209019
20	10.90	5	009209020
21	10.90	5	009209021
22	10.90	5	009209022
23	12.80	5	009209023
24	12.80	5	009209024
25	12.80	5	009209025
26	13.20	5	009209026
27	13.20	5	009209027
28	13.20	5	009209028
29	13.50	5	009209029
30	13.50	5	009209030
32	14.30	5	009209032

920/21K

12"



L mm	CHF		
125	21.30	5	009209822

920/25K

12"



L mm	CHF		
75	33.50	5	009209830

920/55K

7/8"

12"



L mm	CHF		
275	80.00	3	009209882

920/58K

12"



L mm	CHF		
281	120.00	1	009209926

935K



mm	CHF		
6x7	10.70	5	009359105
8x9	11.50	5	009359111
10x11	12.90	5	009359115
12x13	14.30	5	009359117
14x15	16.60	5	009359126
16x17	18.10	5	009359128
18x19	21.30	5	009359131
20x22	25.50	3	009359138

937K



mm	CHF		
6x6	11.50	5	009379006
7x7	12.00	5	009379007
8x8	12.50	5	009379008
9x9	13.30	5	009379009
10x10	13.60	5	009379010
11x11	14.30	5	009379011
12x12	16.00	5	009379012
13x13	16.40	5	009379013
14x14	17.90	5	009379014
15x15	19.70	5	009379015
16x16	21.20	5	009379016
17x17	22.10	5	009379017
18x18	22.60	5	009379018
19x19	23.40	5	009379019
20x20	26.00	5	009379020
21x21	28.50	3	009379021
22x22	30.00	3	009379022

943BXK



mm	CHF	5	009439005
5,5	22.60	5	009439005
6	22.60	5	009439006
7	24.10	5	009439007
8	24.10	5	009439008
10	26.00	3	009439010
13	27.50	3	009439013

951K



mm	CHF	5	009519521
2	24.90	5	009519521
2,5	24.90	5	009519525
3	24.90	5	009519530
3,5	25.50	5	009519535
4	25.50	5	009519540
4,5	28.00	5	009519545
5	28.00	5	009519550
6	32.00	5	009519560
8	34.50	5	009519580
10	44.00	5	009519610

1032K



L mm	CHF	5	010329013
140x0,9	33.00	5	010329013
140x1,3	32.00	5	010329014
180	34.50	5	010329017

1033K



L mm	CHF	5	010339013
140x0,9	37.00	5	010339013
140x1,3	36.00	5	010339014
180	38.00	5	010339017

1034K



L mm	CHF	5	010349013
130x0,9	37.00	5	010349013
130x1,3	36.00	5	010349014
170	38.00	5	010349017

1036K



L mm	CHF	5	010369013
140x0,9	35.50	5	010369013
140x1,3	34.50	5	010369014
175	36.00	5	010369017

1037K



L mm	CHF	5	010379013
140x0,9	39.50	5	010379013
140x1,3	38.00	5	010379014
175	39.50	5	010379017

1038K



L mm	CHF	5	010389013
135x0,9	39.50	5	010389013
135x1,3	38.00	5	010389014
175	39.50	5	010389017

1044K



L mm	CHF	5	010449250
250	43.50	5	010449250

1044FK



L mm	CHF	5	010449015
250	33.50	5	010449015

Beta

1048NK



L mm	CHF	5	010489910
175	36.00	3	010489910
250	38.00	5	010489915

1048V NK



L mm	CHF	5	010489111
175	35.50	3	010489111
250	40.50	5	010489116

1052K



L mm	CHF	5	010529014
140	35.50	3	010529014
190	39.50	3	010529019
240	43.50	3	010529024

1082K



L mm	CHF	5	010829004
140	34.00	5	010829004
160	35.50	5	010829006

1082GK



L mm	CHF	5	010829064
140	29.50	5	010829064
160	31.00	5	010829066

Beta

1082BMK



L mm	CHF	Weight	Code
140	42.50	3	010829034
160	46.50	3	010829036

1082GBMK



L mm	CHF	Weight	Code
140	37.00	3	010829264
160	42.00	3	010829266

1084K



L mm	CHF	Weight	Code
160	39.50	3	010849006

1084GK



L mm	CHF	Weight	Code
160	34.50	5	010849066

1084BMK



L mm	CHF	Weight	Code
160	48.50	3	010849036

1084GBMK



L mm	CHF	Weight	Code
160	53.50	3	010849266

1088K



L mm	CHF	Weight	Code
160	49.00	2	010889006

1088BMK



L mm	CHF	Weight	Code
160	60.00	2	010889036

1096K



L mm	CHF	Weight	Code
200	30.50	5	010969020

1098K



L mm	CHF	Weight	Code
190	26.00	5	010989190
220	29.50	5	010989220

1098PLK



L mm	CHF	Weight	Code
220	33.00	5	010989320

1112K



L mm	CHF	Weight	Code
200	34.50	2	011129020

1122K



L mm	CHF	Weight	Code
250	47.00	2	011229020

1123K



L mm	CHF	Weight	Code
250	47.00	2	011239020

1124K



L mm	CHF	Weight	Code
250	47.00	2	011249020

1128BAX



L mm	CHF	Weight	Code
150	44.00	5	011280088

1128BMX



L mm	CHF	Weight	Code
147	23.40	5	011280051

1128BSX



L mm	CHF	🔧	📦
148	40.50	5	011280061

1128FX



L mm	CHF	🔧	📦
145	42.50	5	011280090

1128FXS

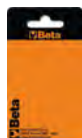

L mm	CHF	🔧	📦
145	51.00	5	011280095

1129BMK



L mm	CHF	🔧	📦
145	22.80	5	011299000

1130BMX



L mm	CHF	🔧	📦
185	26.00	1	011300002

1132K



L	CHF	🔧	📦
170	66.50	2	011329107

1132BMK



L	CHF	🔧	📦
170	82.00	2	011329137

1142BMK



L mm	CHF	🔧	📦
160	54.00	3	011429036

1144T



L mm	CHF	🔧	📦
112	27.50	1	011440060

1149F



L mm	CHF	🔧	📦
175	22.70	1	011490010

1150K



L mm	CHF	🔧	📦
160	30.00	5	011509046
180	33.00	5	011509048
200	35.50	5	011509050
220	39.00	2	011509052

1150GK



L mm	CHF	🔧	📦
160	28.00	5	011509066
180	30.50	5	011509068
200	34.00	5	011509070
220	35.50	2	011509072

1150BMK



L mm	CHF	🔧	📦
160	37.00	3	011509146
180	41.00	3	011509148
200	45.00	3	011509150
220	48.50	2	011509152

1150GBMK



L mm	CHF	🔧	📦
160	34.50	3	011509266
180	37.00	3	011509268
200	42.50	3	011509270
220	45.00	2	011509272

1162K



L mm	CHF	🔧	📦
160	35.50	5	011629006
200	41.00	5	011629010

1162GK

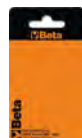

L mm	CHF	🔧	📦
160	30.00	5	011629066
200	34.50	5	011629070

1162BMK



L mm	CHF	🔧	📦
160	43.50	3	011629036
200	48.50	3	011629040

1162GBMK



L mm	CHF	U	Code
160	37.00	3	011629266
200	44.00	3	011629270

1164K



L mm	CHF	U	Code
160	38.50	5	011649006
200	43.50	5	011649010

1164BMK



L mm	CHF	U	Code
160	47.00	3	011649036
200	53.50	3	011649040

1166K



L mm	CHF	U	Code
160	35.50	5	011669006
200	41.00	5	011669010

1166GK



L mm	CHF	U	Code
160	30.00	5	011669066
200	34.50	5	011669070

1166BMK



L mm	CHF	U	Code
160	43.50	3	011669036
200	48.50	3	011669040

1166GBMK



L mm	CHF	U	Code
160	37.00	3	011669266
200	44.00	3	011669270

1168K



L mm	CHF	U	Code
160	38.50	5	011689006
200	43.50	5	011689010

1168GK



L mm	CHF	U	Code
160	33.00	5	011689066
200	37.00	5	011689070

1168BMK



L mm	CHF	U	Code
160	47.00	3	011689036
200	53.50	3	011689040

1168GBMK



L mm	CHF	U	Code
160	42.00	3	011689266
200	47.00	3	011689270

1201E/K



SxAxL mm	CHF	U	Code
0,4x2,5x50	5.60	5	012019203
0,4x2,5x75	5.85	5	012019206
0,5x3x75	5.90	5	012019209
0,5x3x100	6.35	5	012019212
0,6x3,5x75	6.35	5	012019218
0,6x3,5x100	6.50	5	012019221
0,8x4x100	6.60	5	012019230
0,8x4x125	6.90	5	012019233
0,8x4x150	7.45	5	012019236
1,0x5,5x100	8.05	5	012019239
1,0x5,5x125	8.50	5	012019240
1,0x5,5x150	8.60	5	012019242
1,2x6,5x100	9.60	5	012019248
1,2x6,5x125	9.90	5	012019250
1,2x6,5x150	10.10	5	012019251
1,2x8x150	13.00	3	012019257
1,2x8x200	13.80	3	012019260
1,6x10x200	16.00	3	012019266

1201EN/K



SxAxL mm	CHF	U	Code
0,8x4x30	8.00	3	012019303
1,2x6,5x30	8.30	3	012019306

1202E/K



PHxDxL mm	CHF	U	Code
0x3x60	5.85	5	012029203
0x3x100	6.50	5	012029206
1x4,5x80	7.40	5	012029209
1x4,5x120	8.25	5	012029212
2x6x100	9.90	5	012029218
2x6x150	10.70	5	012029221
3x8x150	13.40	3	012029224
4x9,5x200	17.50	3	012029227

1202EN/K



PHxDxL mm	CHF	U	Code
1x4,5x30	8.00	3	012029303
2x6x30	8.30	3	012029306

1204E/K



SxDxL mm	CHF	U	Code
0,4x2,5x60	5.75	5	012049103
0,6x3x75	5.90	5	012049106
0,5x3x100	6.00	5	012049109
0,8x4x100	6.75	5	012049112
0,8x4x125	7.00	5	012049115
1,0x5x125	8.15	5	012049118
1,0x5x150	8.80	5	012049121
1,2x6,5x150	9.60	5	012049124



1207E TX/K



	CHF		
T5	8.50	5	012079105
T6	9.00	5	012079106
T7	9.20	5	012079107
T8	9.35	5	012079108
T9	9.80	5	012079109
T10	11.00	5	012079110
T15	11.20	5	012079115
T20	11.40	5	012079120
T25	11.70	5	012079125
T27	12.50	5	012079127
T30	12.70	5	012079130
T40	14.60	2	012079140
T45	16.10	2	012079145

1208E RTX/K



	CHF		
T9	9.90	5	012089109
T10	11.00	5	012089110
T15	11.70	5	012089115
T20	11.90	5	012089120
T25	12.20	5	012089125
T27	13.30	5	012089127
T30	13.60	5	012089130
T40	16.30	2	012089140

1209E PZ/K



PZ	CHF		
0	6.75	5	012099200
1	8.60	5	012099203
2	11.00	5	012099206
3	16.60	3	012099209
4	18.10	3	012099212

1209EN-PZ/K



	CHF		
1	8.00	3	012099303
2	8.30	3	012099306

1253



SxAxL mm	CHF		
0,5x3,5x100	12.50	5	012530001

1254



SxAxL mm	CHF		
0,5x3x44	13.80	5	012540001

1260K



SxAxL mm	CHF		
0,4x2,5x50	7.65	5	012609003
0,4x2,5x75	8.00	5	012609006
0,5x3x75	8.05	5	012609009
0,5x3x100	8.30	5	012609012
0,6x3,5x75	8.60	5	012609018
0,6x3,5x100	8.75	5	012609021
0,8x4x100	9.55	5	012609030
0,8x4x125	9.90	5	012609033
0,8x4x150	10.40	5	012609036
1x5,5x100	10.90	5	012609039
1x5,5x150	12.20	5	012609042
1,5x6,5x100	13.20	5	012609048
1,2x6,5x150	13.90	5	012609051
1,2x8x150	17.00	3	012609057
1,2x8x200	17.50	3	012609060
1,6x10x200	21.20	3	012609066

1260NK



SxAxL mm	CHF		
0,8x4x30	10.10	5	012609103
1,2x6,5x30	11.20	5	012609106

1260EK



SxAxL mm	CHF		
1,2x6,5x150	18.00	3	012609156
1,2x8x175	22.10	3	012609157
1,6x10x200	25.50	2	012609159
2x12x250	29.50	2	012609162

1262K



PHxDxL mm	CHF		
0x3x60	8.05	5	012629003
0x3x100	8.55	5	012629006
1x4,5x80	10.60	5	012629009
1x4,5x120	11.50	5	012629012
2x6x100	13.00	5	012629018
2x6x150	14.00	5	012629021
3x8x150	18.70	3	012629024
4x10x200	23.80	3	012629027

1262NK



PHxDxL mm	CHF		
1x4,5x30	10.10	5	012629103
2x6x30	11.20	5	012629106

1262EK



PHxDxL mm	CHF		
2x6x150	18.00	3	012629153
3x8x175	21.70	3	012629156
4x10x200	27.00	3	012629159

1264K



SxDxL mm	CHF		
0,5x2,5x60	7.65	5	012649003
0,6x3x75	8.05	5	012649006
0,6x3x100	8.30	5	012649009
0,8x4x100	9.55	5	012649012
0,8x4x125	9.90	5	012649015
1x5x125	11.20	5	012649018
1x5x150	11.70	5	012649021
1,2x6,5x150	13.90	5	012649024

1267TXK



	CHF		
T5	11.30	5	012679005
T6	11.70	5	012679006
T7	12.20	5	012679007
T8	12.80	5	012679008
T9	13.30	5	012679009
T10	13.50	5	012679010
T15	14.30	5	012679015
T20	15.00	5	012679020
T25	16.40	5	012679025
T27	17.00	5	012679027
T30	17.90	5	012679030
T40	20.70	2	012679040
T45	22.70	2	012679045

1268RTXK



⊕	CHF	🔧	📦
T9	14.10	3	012689009
T10	14.60	3	012689010
T15	15.00	3	012689015
T20	16.40	3	012689020
T25	16.70	3	012689025
T27	17.90	3	012689027
T30	18.10	3	012689030
T40	21.00	2	012689040

1269PZK



PZ	CHF	🔧	📦
0	9.20	5	012699000
1	11.90	5	012699001
2	14.10	5	012699002
3	20.20	3	012699003
4	25.50	3	012699004

1269N/PZK



PZ	CHF	🔧	📦
1	10.10	5	012699011
2	11.20	5	012699012

1290K



SxAxL mm	CHF	🔧	📦
0,4x2,5x50	9.50	5	012909003
0,4x2,5x75	9.80	5	012909006
0,5x3x75	10.00	10	012909009
0,5x3x100	10.50	10	012909012
0,6x3,5x75	11.40	10	012909018
0,6x3,5x100	11.50	10	012909021
0,8x4x100	11.70	10	012909030
0,8x4x125	12.00	10	012909033
0,8x4x150	12.80	10	012909036
1x5,5x100	13.00	10	012909039
1x5,5x150	14.30	10	012909042
1,2x6,5x100	16.00	10	012909048
1,2x6,5x150	16.90	10	012909051
1,2x8x150	21.10	3	012909057
1,2x8x200	22.30	3	012909060
1,6x10x200	26.00	3	012909066

1290NK



SxAxL mm	CHF	🔧	📦
0,8x4x30	12.30	5	012909103
1,2x6,5x30	13.50	5	012909106

1290K/INOX



SxAxL mm	CHF	🔧	📦
0,4x2,5x50	12.40	4	012909403
0,5x3x75	12.80	4	012909409
0,8x4x100	13.30	4	012909430
1,0x5,5x150	16.50	4	012909442
1,2x6,5x150	18.90	4	012909451

1292K



PHxDxL mm	CHF	🔧	📦
0x3x60	9.05	10	012929003
0x3x100	10.40	5	012929006
1x4,5x80	12.50	10	012929009
1x4,5x120	13.60	10	012929012
2x6x100	16.30	10	012929018
2x6x150	17.40	10	012929021
3x8x150	22.10	3	012929024
4x10x200	30.00	3	012929027

1292NK



PHxDxL mm	CHF	🔧	📦
1x4,5x30	11.80	5	012929103
2x6x30	12.90	5	012929106

1292K/INOX



PHxDxL mm	CHF	🔧	📦
0x3x60	11.60	4	012929403
1x4,5x80	13.50	4	012929409
2x6x100	16.50	4	012929418

1294K



SxDxL mm	CHF	🔧	📦
0,5x2,5x60	8.85	5	012949003
0,6x3x75	9.35	5	012949006
0,8x4x100	11.70	5	012949012
1x5x125	14.40	5	012949018

1298RTXK



⊕	CHF	🔧	📦
T9	19.10	5	012989009
T10	19.60	5	012989010
T15	20.80	5	012989015
T20	21.00	5	012989020
T25	21.30	5	012989025
T27	23.10	5	012989027
T30	23.90	5	012989030
T40	25.50	2	012989040

1299PZK



PZ	CHF	🔧	📦
0	13.00	5	012999000
1	15.00	5	012999003
2	20.50	5	012999006

1299N/PZK



PZ	CHF	🔧	📦
1	14.60	5	012999021
2	16.30	5	012999024

1472VW



L mm	CHF	🔧	📦
200	60.50	1	014720051

Beta
Quality Tools

1473P



A Max mm	CHF		
53	47.00	1	014730020

1497BS



L mm	CHF		
230	30.00	1	014970190

1497SS



L mm	CHF		
245	27.50	1	014970195

1497RC



1497RC	CHF		
	98.00	1	014970351

1600Q 8



1600Q 8	CHF		
	38.00	1	016000008

1600Q 10



1600Q 8	CHF		
	38.00	1	016000008

1603K



	CHF		
mm ² 0-8	21.30	5	016039001

1603BK



	CHF		
mm ² 0-8	79.50	2	016039010

1651DGTB

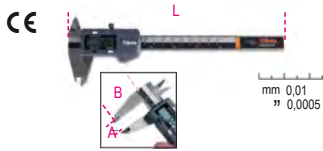

A Max mm	CHF		
150	135.00	1	016510211
200	176.00	1	016510212
300	230.00	1	016510213

1651DGTB/IP

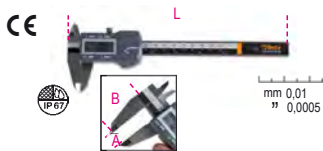

A Max mm	CHF		
150	220.50	1	016510711

1691BM



L m	CHF		
5	20.70	1	016910205
8	31.00	1	016910208
10	38.00	1	016910210



1691MG

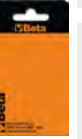

L m	CHF		
5	18.60	1	016910405
8	26.00	1	016910408
10	27.50	1	016910410

1692

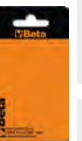

L m	CHF		
2	10.10	5	016920052
3	12.50	5	016920053
5	17.90	5	016920055
8	26.00	5	016920058

1693



IP54

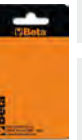

H mm	CHF		
100	158.50	1	016930020

1729CG



L mm	CHF		
310	30.50	2	017290200

1729DM 450

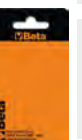

L mm	CHF		
450	34.50	4	017290450

1741U



Ø mm	2,4	3	3,2	4	4,8
Aluminium	•	•	•	•	•
Acier	•	•	•	•	•
Acier inoxydable	•	•	•	•	•

1741U CHF 60.00 1 017410450

1741B



Ø mm	2,4	3,2	4	4,8	5
Aluminium	•	•	•	•	•
Acier	•	•	•	•	•
Inox	•	•	•		

1741B CHF 51.00 1 017410000

1760K



CE



CAT III-1000V

1760K CHF 47.50 1 017600140

1762K



Ø mm CHF 41.00 2 017629001
2-2,5-3
3,5-4-4,5

1771

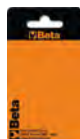

1771 CHF 12.30 10 017710000

1770BM



L mm CHF 16.60 10 017700050
140

1771BM



L mm CHF 27.00 10 017710050
170

1771HD



L mm CHF 30.00 5 017710100
190

1772R



L mm CHF 22.70 5 017720006
125

1773A



L mm CHF 23.90 10 017730000
180

1777BMT



L mm CHF 36.50 5 017770050
170

1777T



L mm CHF 34.00 5 017770030
160

1778MT



L mm CHF 130.00 1 017780055
180

1783



L mm CHF 20.00 5 017830021
215
240 CHF 22.30 5 017830024

1820



1820 30 CHF 58.00 1 018200003
30W

L = 210mm 1820 60 CHF 66.50 1 018200006
60W

L = 220mm 1820 80 CHF 94.00 1 018200008
80W

L = 260mm



1822



230V
Shuko
L=1,25 m



1822 120	CHF 144.00	1	018220012
120W LxA = 250x125 mm			
1822 180	152.00	1	018220018
180W LxA = 250x125mm			
1822 320	189.00	1	018220032
320W LxA = 250x140mm			

1833S



L mm	CHF	1	018330002
150	48.50		

1833M



L mm	CHF	1	018330003
162	60.50		

1833L



L mm	CHF	1	018330004
196	101.00		

1833XL



L mm	CHF	1	018330005
300	126.50		

1833L/USB



L mm	CHF	1	018330054
240	148.00		

1834RR



1834RR	CHF 67.00	1	018340520
--------	-----------	---	-----------

1836AW



1836AW	CHF 91.00	1	018360051
--------	-----------	---	-----------

1836B



1836B	CHF 165.00	1	018360200
-------	------------	---	-----------



1837F



L mm	CHF	1	018370050
460	109.00		

1837F/USB



L mm	CHF	1	018370060
460	162.00		

1838COB

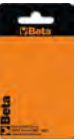

1838COB	CHF 118.50	1	018380010
---------	------------	---	-----------

1838P



1838P	CHF 101.50	1	018380005
-------	------------	---	-----------

Beta

1838POCKET



L mm **CHF** 1 018380080

98 86.00

1838SLIM



L mm **CHF** 1 018380221

307 92.50

1838SW



L mm **CHF** 1 018380142

260 122.50

1839BRW



L mm **CHF** 1 018390002

101 116.00

1860M



L max mm **CHF** 1 018600301

30 110.50

1875SP/K3



CHF 1 018750010

23.70

1949F2



CHF 1 019490028

125 21.80

6888B1/4

Broche blister pour douilles 1/4"



CHF 50 068880900

0.86

6888B3/8

Broche blister pour douilles 3/8"



CHF 50 068880910

1.02

6888B1/2

Broche blister pour douilles 1/2"



CHF 50 068880920

1.02

Beta

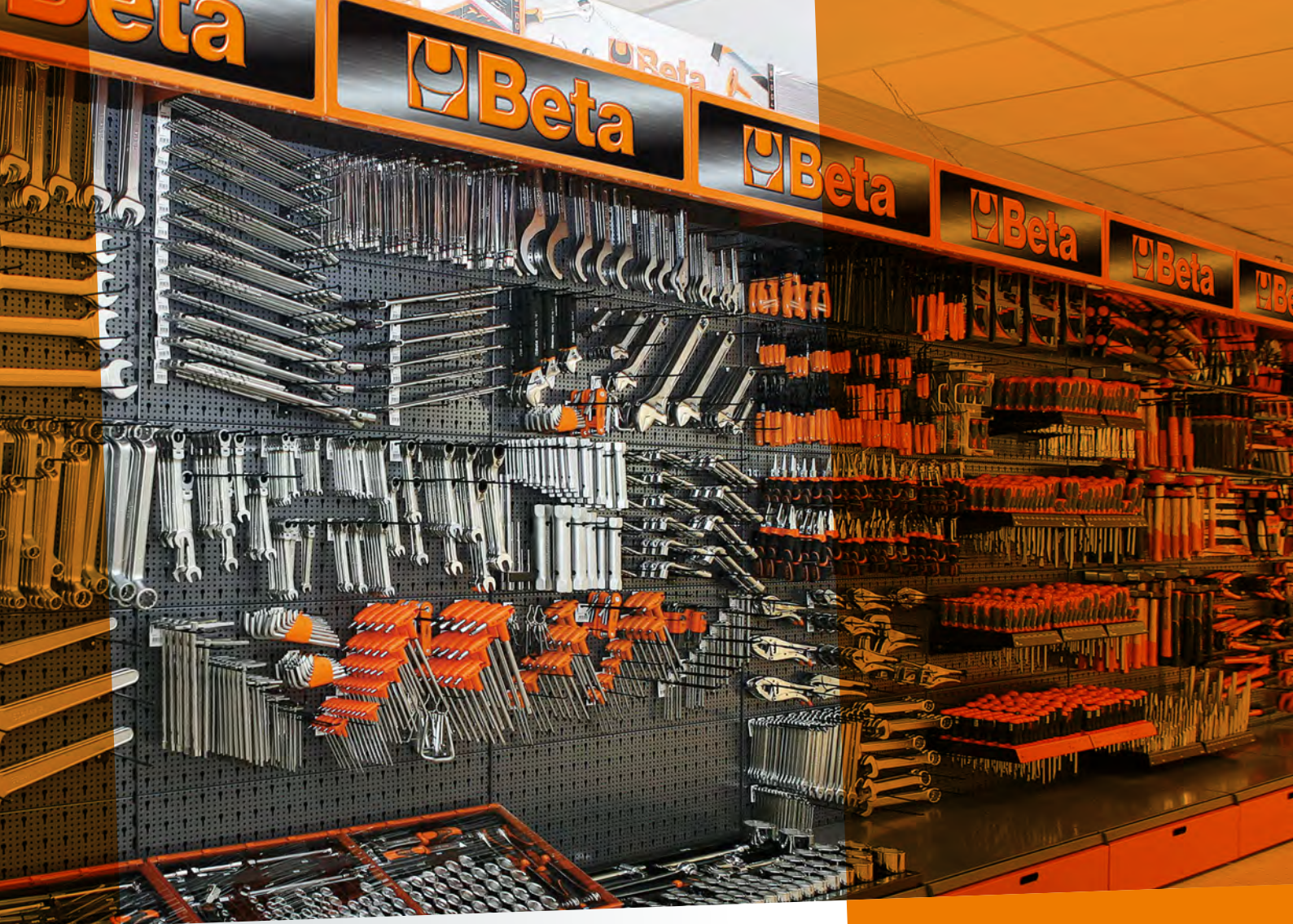

SOLUTIONS POUR LE POINT DE VENTE

SHOP
in Shop



**CONSTRUISEZ VOTRE
CORNER BETA**

www.beta-tools.com/planner3d/

38/DS1

Présentoir mural avec 75 outils à frapper



495x260x332 mm

Présentoir avec composition
38/DS1 CHF 916.00 1 000380701

	n.
30	5
31	5
32	5

Présentoir vide
38/DVS1 CHF 144.00 1 000380751

38/DS2

Présentoir mural avec 65 outils à frapper

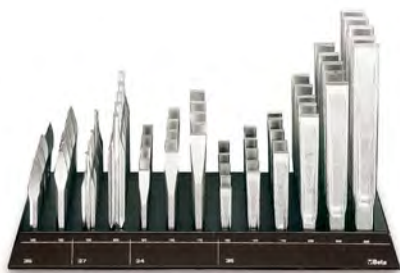

495x260x332 mm

Présentoir avec composition
38/DS2 CHF 1,730.00 1 000380702

	n.
34	5
35	5
36	5
37	5

Présentoir vide
38/DVS2 CHF 144.00 1 000380752

942BX/DG

Présentoir mural avec 43 clés à douille emmanchées, série courte



330x260x332 mm

Présentoir avec composition
942BX/DG CHF 934.00 1 009420701

	n.
942BX 5 - 5,5 mm	3
6 - 7 mm	6
8 - 9 - 10 mm	5
11 mm	2
12 mm	3
13 mm	5

Présentoir vide
942BX/DVG CHF 127.00 1 009420751

943BX/DG

Présentoir mural avec 43 clés à douille emmanchées, série longue



330x260x332 mm

Présentoir avec composition
943BX/DG CHF 1,003.00 1 009430701

	n.
943BX 5 - 5,5 mm	3
6 - 7 mm	6
8 - 9 - 10 mm	5
11 mm	2
12 mm	3
13 mm	5

Présentoir vide
943BX/DVG CHF 127.00 1 009430751

944BX/DG

Présentoir mural avec 43 clés à douille profondes emmanchées, série longue
Présentoir mural avec 43 tournevis emmanché emmanchées, série longue



330x260x332 mm

Présentoir avec composition
944BX/DG CHF 1,161.00 1 009440701

	n.
944BX 5 - 5,5 mm	3
6 - 7 mm	6
8 - 9 - 10 mm	5
11 mm	2
12 mm	3
13 mm	5

Présentoir vide
944BX/DVG CHF 127.00 1 009440751

943MQ/BG

Présentoir mural avec 30 clés à douille emmanchées



⚡ 1000 V ⚡

330x260x332 mm

Présentoir avec composition
943MQ/BG CHF 807.00 1 009430281

	n.
943MQ 5,5 - 6 - 7 - 8 - 10 - 13 mm	5

Présentoir vide
943BG-MQ/DV CHF 127.00 1 009430285

1203/E1P

Présentoir mural avec 82 tournevis



495x260x310 mm

Présentoir avec composition
1203E/E1P CHF 609.00 1 012031301

Code	Description	Quantité
● 1201	0,4x2,5x50 - 0,5x3x75 - 0,6x3,5x100 0,8x4x100 - 0,8x4x125 mm 1,0x5,5x100 - 1,0x5,5x150 - 1,2x6,5x150 mm 1,2x8x150 mm	n. 7 6 5
⊕ 1202	PH0x3x60 mm PH1x4,5x80 - PH2x6x100 mm PH3x8x150 mm	7 6 5

Présentoir vide
1203E/EV1P CHF 158.50 1 012031351

1203/E4P

Présentoir mural avec 82 tournevis



495x260x310 mm

Présentoir avec composition
1203E/E4P CHF 585.00 1 012031304

Code	Description	Quantité
● 1201	0,4x2,5x50 - 0,5x3x75 - 0,8x4x125 mm 1,0x5,5x100 - 1,0x5,5x150 - 1,2x6,5x150 mm	7 6
● 1204	0,4x2,5x60 - 0,5x3x100 - 0,8x4x100 mm 1,0x5x125 mm	7 6
⊕ 1209PZ	PZ0x3x60 mm PZ1x4,5x80 - PZ2x6x100 mm	7 6

Présentoir vide
1203E/EV4P CHF 158.50 1 012031354

1203/E5P

Présentoir mural avec 82 tournevis



495x260x310 mm

Présentoir avec composition
1203E/E5P CHF 620.00 1 012031305

Code	Description	Quantité
⊕ 1202	PH0x3x60 mm PH1x4,5x80 - PH1x4,5x120 PH2x6x100 - PH2x6x150 mm PH3x8x150 mm	7 6 5 5
● 1204	0,4x2,5x60 - 0,5x3x100 - 0,8x4x100 mm 1,0x5x125 mm	7 6
⊕ 1209PZ	PZ0x3x60 mm PZ1x4,5x80 - PZ2x6x100 mm	7 6

Présentoir vide
1203E/EV5P CHF 158.50 1 012031355

1203/E10P

Présentoir mural avec 82 tournevis



495x260x310 mm

Présentoir avec composition
1203E/E10P CHF 832.00 1 012031310

Code	Description	Quantité
⊕ 1207TX	T6 T7 T8 T9 - T10 - T15 - T20 - T25 T27 - T30	n. 4 3 7 6 3
⊕ 1208RTX	T9 - T10 T15 - T20 - T25 T27 - T30	3 6 3

Présentoir vide
1203E/EV10P CHF 158.50 1 012031360

1263/E78

Présentoir mural avec 78 tournevis



495x260x310 mm

Présentoir avec composition
1263/E78 CHF 797.00 1 012630510

Code	Description	Quantité
● 1260	2,5x75-3x75-3,5x100 mm 4x100-4x125-5,5x100-5,5x150-6,5x150 mm 8x150 mm	7 6 4
⊕ 1262	PH0x60 mm PH1x80-PH2x100 mm PH3x150	7 6 4

Présentoir vide
1263/EV78 CHF 146.50 1 012630511

1263/E74

Présentoir mural avec 74 tournevis



495x260x310 mm

Présentoir avec composition
1263/E74 CHF 744.00 1 012630540

Code	Description	Quantité
● 1264	2,5x60 mm 3x75 mm 3x100 - 4x100 mm 4x125 - 5x150 mm 5x125 - 6,5x150 mm	7 3 4 2 4
⊕ 1262	PH 8x150 PH 3x60 - 3x100 mm PH 4,5x80 - 4,5x120 mm PH 6x100 mm PH 6x150 mm	3 7 6 10 5

Présentoir vide
1263/EV74 CHF 146.50 1 012630541

1263/E85
Présentoir mural
avec 85 tournevis



495x260x377 mm

Présentoir
avec composition
1263/E85 CHF 887.00 1 012630550

		n.
● 1260	2,5x50 mm	7
	2,5x75 mm	6
	3x75 - 3x100 - 3,5x100 mm	7
	4x100 - 4x125 - 5,5x125	6
	5,5x150 - 6,5x150 mm	4
● 1260E	8x150 mm	4
	10x200 mm	3
	12x250 mm	2
	4x30 - 6,5x30 mm	6

Présentoir vide
1263/EV85 CHF 146.50 1 012630551

1263/E50
Présentoir mural
avec 50 tournevis



330x260x269 mm

Présentoir
avec composition
1263/E50 CHF 458.00 1 012630570

		n.
● 1264	2,5x60 - 3x75 - 3x100 mm	7
	4x100 - 4x125 - 5x125 - 5x150 mm	6
	6,5x150 mm	5

Présentoir
vide
1263/EV50 CHF 127.00 1 012630571

1263/E39
Présentoir mural
avec 39 tournevis



330x260x257 mm

Présentoir
avec composition
1263/E39 CHF 596.00 1 012630595

		n.
⊕ 1268RTX	T9x60 - T10x80 - T15x80	6
	T20x100 - T25x100 mm	4
	T27x115 mm	3
	T30x115 mm	2
	T40x130 mm	2

Présentoir
vide
1263/EV39 CHF 127.00 1 012630596

1263/E70
Présentoir mural
avec 70 tournevis



495x260x327 mm

Présentoir
avec composition
1263/E70 CHF 873.00 1 012630560

		n.
⊕ 1262	PH0x60 - PH0x100 mm	7
	PH1x80 - PH1x120 mm	6
	PH2x100 mm	9
	PH2x150 - PH3x150 mm	5
	PH4x200 mm	4
⊕ 1262E	PH2x150 mm	5
	PH3x175 mm	4
⊕ 1262N	PH1x30 - PH2x30 mm	6

Présentoir vide
1263/EV70 CHF 146.50 1 012630561

1263/E62
Présentoir mural
avec 62 tournevis



495x260x257 mm

Présentoir
avec composition
1263/E62 CHF 843.00 1 012630590

		n.
⊕ 1267TX	T5	5
	T6	6
	T7	5
	T8	6
	T9	5
	T10 - T15 - T20	6
	T25	5
	T27 - T30	4
	T40 - T45	2

Présentoir
vide
1263/EV62 CHF 146.50 1 012630591

1263/E40
Présentoir mural
avec 40 tournevis



330x260x327 mm

Présentoir
avec composition
1263/E40 CHF 531.00 1 012630580

		n.
⊕ 1269	PZ0x60 mm	7
	PZ1x80 mm	6
	PZ2x100 - PZ3x150 - PZ4x200 mm	5
⊕ 1269N	PZ1x30 - PZ2x30 mm	6

Présentoir
vide
1263/EV40 CHF 127.00 1 012630581

1273MQ/E1

Présentoir mural avec 40 tournevis



± 1000 V

330x260x332 mm

Présentoir avec composition
1273MQ/E1 CHF 677.00 1 012730312

Code	Description	n.
1272MQ	PH0x60 - PH1x80 mm	5
	PH2x100 mm	3
	PH3x150 mm	2
1274MQ	3x100 - 4x100 - 5,5x125 - 6,5x150 mm	5
	8x175 mm	3
	10x200 mm	2

Présentoir vide
1273BG-MQ/DV CHF 127.00 1 012730651

1273MQ/E4

écran mural avec 43 tournevis



± 1000 V

330x260x332 mm

Présentoir avec composition
1273MQ/E4 CHF 919.00 1 012730315

Code	Description	n.
1272MQF	4,5x80 - 6x100 mm	3
1274MQF	3,5x100 - 4,5x100 - 5,5x125 - 6,5x150 mm	3
1275MQ/C	4,5x80 - 6x100 mm	5
1276MQ/C	4,5x80 - 6x100 mm	5
1279MQ/F	4,5x80 mm	3
	6x100 mm	2

Présentoir vide
1273BG-MQ/DV4 CHF 127.00 1 012730655

1293BX/DA

Présentoir mural avec 90 tournevis



495x260x332 mm

Présentoir avec composition
1293BX/DA CHF 1,159.00 1 012930701

Code	Description	n.
1290	3x75 - 3,5x100 - 4x100 - 4x125 5,5x100 - 5,5x150 mm	7
	6,5x150 mm	6
	8x150 mm	3
	10x200 mm	2
1290N	4x30 - 6,5x30 mm	3
1292	PH0x60 - PH1x80 mm	7
	PH2x100 mm	6
	PH3x150 mm	5
1292N	PH1x30 - PH2x30 mm	3

Présentoir vide
1293BX/DVA CHF 147.00 1 012930751

1293BX/DD

Présentoir mural avec 48 tournevis



330x260x332 mm

Présentoir avec composition
1293BX/DD CHF 548.00 1 012930704

Code	Description	n.
1294	2,5x60 - 3x75 - 3x100 - 4x100 4x150 - 5x125 mm	7
	6,5x150 mm	6

Présentoir vide
1293BX/DVD CHF 128.50 1 012930754

1293BX/DE

Présentoir mural avec 42 tournevis



330x260x332 mm

Présentoir avec composition
1293BX/DE CHF 816.00 1 012930705

Code	Description	n.
1299PZ	PZ0x60 - PZ1x80 mm	7
	PZ2x100 mm	6
	PZ3x150 - PZ4x200 mm	5
1299N/PZ	PZ1x30 - PZ2x30 mm	6

Présentoir vide
1293BX/DVE CHF 128.50 1 012930755

1293BX/DF

Présentoir mural avec 59 tournevis



330x260x332 mm

Présentoir avec composition
1293BX/DF CHF 1,081.00 1 012930706

Code	Description	n.
1297TX	T6 - T8 - T10 - T15 - T20 - T25 T27 - T30	7
	T40	6
		5

Présentoir vide
1293BX/DVF CHF 128.50 1 012930756

C68
Présentoir mural, vide



1000x560x2200 mm

		CHF		
C68/1	1 m	2,730.00	1	068000001
C68/2	2 m	4,760.00	1	068000002
C68/3	3 m	6,780.00	1	068000003
C68/4	4 m	8,820.00	1	068000004
C68/5	5 m	10,840.00	1	068000005
C68/6	6 m	12,870.00	1	068000006
C68/7	7 m	14,890.00	1	068000007
C68/8	8 m	16,930.00	1	068000008
C68/9	9 m	18,950.00	1	068000009
C68/10	10 m	20,980.00	1	068000010

C68N
Présentoir mural Beta, vide



1000x560x2200 mm

		CHF		
C68N/1	1 m	2,355.00	1	068000031
C68N/2	2 m	4,380.00	1	068000032
C68N/3	3 m	6,410.00	1	068000033
C68N/4	4 m	8,430.00	1	068000034
C68N/5	5 m	10,470.00	1	068000035
C68N/6	6 m	12,490.00	1	068000036
C68N/7	7 m	14,520.00	1	068000037
C68N/8	8 m	16,540.00	1	068000038
C68N/9	9 m	18,580.00	1	068000039
C68N/10	10 m	20,600.00	1	068000040

C68 G
Présentoir gondole vide



1000x1120x1600 mm

		CHF		
C68G/1	1 m	2,485.00	1	068000051
C68G/2	2 m	4,580.00	1	068000052
C68G/3	3 m	6,670.00	1	068000053
C68G/4	4 m	8,770.00	1	068000054

C88 R/1
Présentoir mural Robur, vide



1000x560x2200 mm

		CHF		
C88R/1	1 m	2,730.00	1	088000001

C88NR/1
Présentoir mural Robur, vide



1000x560x2200 mm

		CHF		
C88NR/1	1 m	2,355.00	1	088000031

C88VE
Plateau d'exposition pour présentoir mural C88
Apte au rangement de rouleaux de chaîne art. 8120



		CHF		
C88VE		296.00	1	088000120

C88SE
Présentoir pour bobines chaîne type "Genovese"



		CHF		
C88SE		714.00	1	088000130

1700x600x600 mm



6888

Crochets pour présentoirs
C60 - C61 - C68 - C88

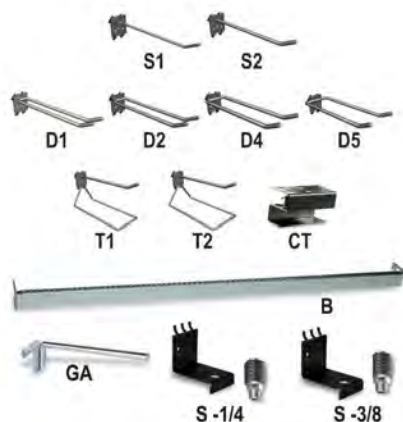

		CHF		
6888S1		5.65	10	068880011
6888S2		5.65	10	068880012
6888D1		8.85	5	068880021
6888D2		8.85	5	068880022
6888D4		9.10	5	068880024
6888D5		9.10	5	068880025
6888T1		12.50	5	068880031
6888T2		12.50	5	068880032
6888CT		23.70	1	068880044
6888B		71.50	1	068880100
6888GA		28.00	3	068880120
6888S-1/4		50.00	1	068880605
6888S-3/8		50.00	1	068880610

6800 VE

Vitrine pour paroi d'exposition C68 et C68 R/1

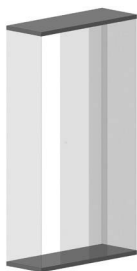

		CHF		
6800VE/1	1 m	1,360.00	1	068000401
6800VE/2	2 m	2,075.00	1	068000402
6800VE/3	3 m	2,790.00	1	068000403
6800VE/4	4 m	3,510.00	1	068000404
6800VE/5	5 m	4,220.00	1	068000405



	CHF		
6800AE	272.00	1	068000145
6800AI	562.00	1	068000140
6800AD/P	957.00	1	068000143

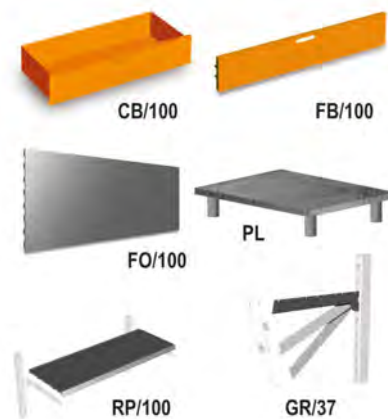

	CHF		
6800CB/100	314.00	1	068000104
6800FB/100	110.50	1	068000109
6800FO/100	75.50	1	068000108
6800PL	319.00	1	068000137
6800RP/100	101.00	1	068000150
6800GR/37	42.50	1	068000159



	CHF		
6800PM/40	101.00	1	068000171
6800PM/80	136.50	1	068000172

6600 M/14

Composition de 154 outils,
avec crochets sans panneau



	CHF		
6600 M/14	3,020.00	1	066000014

6600 M/22

Composition de 108 outils,
avec crochets sans panneau



	CHF		
6600 M/22	2,045.00	1	066000022

6600 M/27

Composition de 25 outils,
avec crochets sans panneau



	CHF		
6600 M/27	1,425.00	1	066000027

6600 M/29

Composition de 173 outils,
avec crochets sans panneau

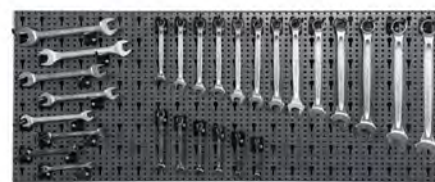

	CHF		
6600 M/29	2,670.00	1	066000029

6600 M/33

Composition de 37 outils, avec crochets sans
panneau



	CHF		
6600 M/33	2,275.00	1	066000033



6600 M/40

Composition de 100 outils,
avec crochets sans panneau



6600 M/40 CHF 3,390.00 1 066000040

6600 M/42

Composition de 65 outils,
avec crochets sans panneau



6600 M/42 CHF 2,180.00 1 066000042

6600 M/44

Composition de 48 outils,
avec crochets sans panneau



6600 M/44 CHF 1,890.00 1 066000044

6600 M/47

Composition de 65 outils,
avec crochets sans panneau



6600 M/47 CHF 2,025.00 1 066000047

6600 M/51

Composition de 257 outils,
avec crochets sans panneau



6600 M/51 CHF 3,610.00 1 066000051

6600 M/52

Composition de 176 outils,
avec crochets sans panneau



6600 M/52 CHF 2,355.00 1 066000052

6600 M/58

Composition de 150 outils,
avec crochets sans panneau



6600 M/58 CHF 2,560.00 1 066000058

6600 M/59

Composition de 220 outils,
avec crochets sans panneau



6600 M/59 CHF 2,730.00 1 066000059

6600 M/61

Composition de 71 outils,
avec crochets sans panneau

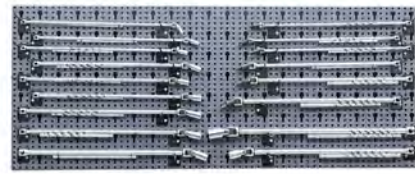

6600 M/61 CHF 3,260.00 1 066000061

6600 M/62

Composition de 28 outils,
avec crochets sans panneau



6600 M/62 CHF 766.00 1 066000062

6600 M/63

Composition de 110 outils,
avec crochets sans panneau

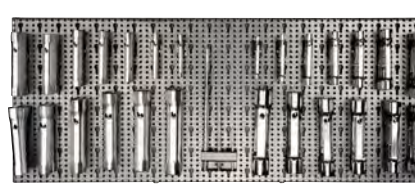

6600 M/63 CHF 2,960.00 1 066000063

6600 M/73

Composition de 68 outils,
avec crochets sans panneau

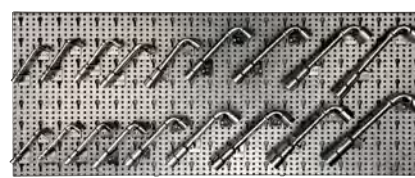

6600 M/73 CHF 1,935.00 1 066000073

6600 M/112

Composition de 329 outils,
avec crochets sans panneau



6600 M/112 CHF 3,190.00 1 066000112

6600 M/116

Composition de 306 outils,
avec crochets sans panneau



6600 M/116 CHF 2,980.00 1 066000116

6600 M/120

Composition de 163 outils,
avec crochets sans panneau



6600 M/120 CHF 2,155.00 1 066000120

6600 M/125

Composition de 133 outils,
avec crochets sans panneau



6600 M/125 CHF 1,860.00 1 066000125

6600 M/126

Composition de 58 outils,
avec crochets sans panneau



6600 M/126 CHF 1,147.00 1 066000126

6600 M/131

Composition de 92 outils,
avec crochets sans panneau



6600 M/131 CHF 3,560.00 1 066000131

6600 M/174

Composition de 13 outils, avec crochets sans
panneau



6600 M/174 CHF 5,490.00 1 066000174

6600 M/175

Composition de 12 outils,
avec crochets sans panneau



6600 M/175 CHF 3,910.00 1 066000175

6600 M/217

Composition de 74 outils,
avec crochets sans panneau



6600 M/217 CHF 3,470.00 1 066000217

6600 M/218

Composition de 58 outils,
avec crochets sans panneau



6600 M/218 CHF 1,830.00 1 066000218

6600 M/222

Composition de 74 outils,
avec crochets sans panneau

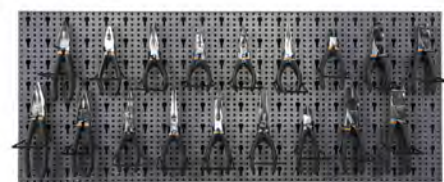

6600 M/222 CHF 2,810.00 1 066000222

6600 M/223

Composition de 58 outils,
avec crochets sans panneau



6600 M/223 CHF 2,395.00 1 066000223

INDUSTRIAL
FINISHING

6600 M/230

Composition de 78 outils,
avec crochets sans panneau



6600 M/230 CHF 3,080.00 1 066000230

6600 M/236

Composition de 31 outils,
avec crochets sans panneau



6600 M/236 CHF 1,735.00 1 066000236

6600 M/241

Composition de 43 outils,
avec crochets sans panneau



6600 M/241 CHF 1,495.00 1 066000241

6600 M/242

Composition de 91 outils,
avec crochets sans panneau



6600 M/242 CHF 3,560.00 1 066000242

6600 M/253

Composition de 60 outils,
avec crochets sans panneau



6600 M/253 CHF 2,485.00 1 066000253

6600 M/311

Composition de 114 outils,
avec crochets sans panneau



6600 M/311 CHF 1,485.00 1 066000311

6600 M/315

Composition de 149 outils,
avec crochets sans panneau



6600 M/315 CHF 2,440.00 1 066000315

6600 M/320

Composition de 98 outils,
avec crochets sans panneau

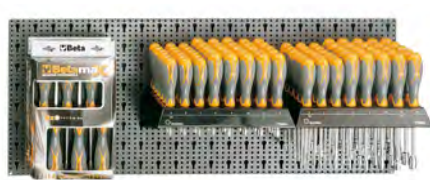

6600 M/320 CHF 2,215.00 1 066000320

6600 M/326

Composition de 155 outils,
avec crochets sans panneau



6600 M/326 CHF 1,760.00 1 066000326

6600 M/327

Composition de 101 outils,
avec crochets sans panneau



6600 M/327 CHF 1,440.00 1 066000327

6600 M/330

Composition de 110 outils,
avec crochets sans panneau



6600 M/330 CHF 1,183.00 1 066000330

6600 M/371

Composition de 162 outils,
avec crochets sans panneau



6600 M/371 CHF 1,440.00 1 066000371

6600 M/380

assortiment de 71 outils, avec crochets sans panneau



6600 M/380 CHF 918.00 1 066000380

6600 M/406

Composition de 107 outils, avec crochets sans panneau



6600 M/406 CHF 1,545.00 1 066000406

6600 M/417

Composition de 43 outils, avec crochets sans panneau



6600 M/417 CHF 1,330.00 1 066000417

6600 M/423

Composition de 30 outils, avec crochets sans panneau



6600 M/423 CHF 1,325.00 1 066000423

6600 M/424

Composition de 36 outils, avec crochets sans panneau



6600 M/424 CHF 1,405.00 1 066000424

6600 M/427

Composition de 24 outils, avec crochets sans panneau



6600 M/427 CHF 1,435.00 1 066000427

6600 M/430

Composition de 29 outils, avec crochets sans panneau



6600 M/430 CHF 1,400.00 1 066000430

6600 M/440

Composition de 140 outils, avec crochets sans panneau

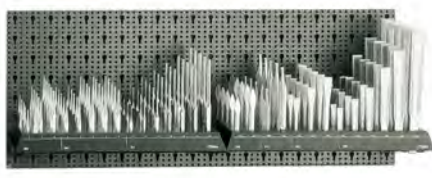

6600 M/440 CHF 2,650.00 1 066000440

6600 M/456

Composition de 41 outils, avec crochets sans panneau



6600 M/456 CHF 2,060.00 1 066000456

6600 M/465

Composition de 36 outils, avec crochets sans panneau



6600 M/465 CHF 2,440.00 1 066000465

6600 M/480

Composition de 18 outils, avec crochets sans panneau



6600 M/480 CHF 1,545.00 1 066000480

6600 M/485

Composition de 12 outils, avec crochets sans panneau



6600 M/485 CHF 1,111.00 1 066000485

6600 M/510

Composition de 16 outils,
avec crochets sans panneau



6600 M/510 CHF 1,520.00 1 066000510

6600 M/532

Composition de 24 outils,
avec crochets sans panneau



6600 M/532 CHF 1,240.00 1 066000532

6600 M/534

Composition de 51 outils,
avec crochets sans panneau



6600 M/534 CHF 2,010.00 1 066000534

6600 M/542

Composition de 53 outils,
avec crochets sans panneau



6600 M/542 CHF 1,235.00 1 066000542

6600 M/548

Composition de 37 outils,
avec crochets sans panneau



6600 M/548 CHF 1,130.00 1 066000548

6600 M/561

Composition de 60 outils,
avec crochets sans panneau



6600 M/561 CHF 1,625.00 1 066000561

6600 M/583

Composition de 22 outils,
avec crochets sans panneau



6600 M/583 CHF 1,136.00 1 066000583

6600 M/643

assortiment de 90 outils, avec crochets sans
panneau



6600 M/643 CHF 2,730.00 1 066000643

6600 M/650

Composition de 28 outils,
avec crochets sans panneau



6600 M/650 CHF 3,320.00 1 066000650

6600 M/657

Composition de 17 outils,
avec crochets sans panneau



6600 M/657 CHF 2,690.00 1 066000657

6600 M/658

Composition de 14 outils,
avec crochets sans panneau

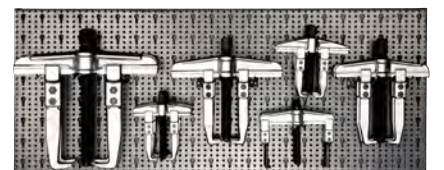

6600 M/658 CHF 3,010.00 1 066000658



6600 M/716

Composition de 64 outils, avec crochets sans panneau



6600 M/716 CHF 3,320.00 1 066000716

6600 M/813

Composition de 25 outils, avec crochets sans panneau



6600 M/813 CHF 1,530.00 1 066000813

6600 M/842

Composition de 36 outils, avec crochets sans panneau



6600 M/842 CHF 1,995.00 1 066000842

6600 M/852

Composition de 560 disques abrasifs rigides, avec crochets sans panneau



6600 M/852 CHF 1,790.00 1 066000852

6600 M/856

Composition de 560 disques abrasifs rigides, avec crochets sans panneau



6600 M/856 CHF 1,880.00 1 066000856

6600 M/857

Composition de 560 disques abrasifs rigides, avec crochets sans panneau



6600 M/857 CHF 1,970.00 1 066000857

6600 M/871

Composition de 120 abrasifs avec crochets sans panneau



6600 M/871 CHF 813.00 1 066000871



6600 M/878

Composition de 100 abrasifs avec crochets sans panneau



6600 M/878 CHF 763.00 1 066000878

6600 M/881

Composition de 410 abrasifs avec plateau d'exposition



6600 M/881 CHF 2,250.00 1 066000881



8600 R/11

Composition de 374 accessoires pour câbles, avec crochets sans panneau



8600 R/11 CHF 2,075.00 1 086000011

8600 R/12

Composition de 259 accessoires pour câbles, avec crochets sans panneau

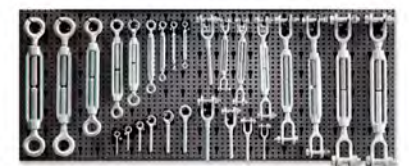

8600 R/12 CHF 2,110.00 1 086000012

8600 R/13

Composition de 230 accessoires pour câbles, avec crochets sans panneau



8600 R/13 CHF 1,755.00 1 086000013

8600 R/113

Composition de 1862 accessoires pour câbles, avec crochets sans panneau



8600 R/113 CHF 2,380.00 1 086000113

8600 R/114

Composition de 1045 accessoires pour câbles, avec crochets sans panneau



8600 R/114 CHF 2,420.00 1 086000114

8600 R/225

Composition de 64 accessoires GRADE 8 avec crochets sans panneau



8600 R/225 CHF 1,660.00 1 086000225

8600 R/412

Composition de 348 accessoires inoxydables pour câbles, avec crochets sans panneau

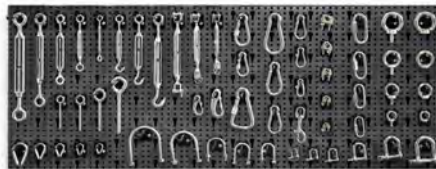

8600 R/412 CHF 2,450.00 1 086000412

8600 R/511

Assortiment de 11 bobines chaîne type "Genovese" avec plateau d'exposition



8600 R/511 CHF 1,990.00 1 086000511

8600 R/601

Composition de 50 cliquets d'arrimage avec grilles, rayon et crochets sans panneau



8600 R/601 CHF 1,575.00 1 086000601
C88/R601 397.00 1 088000160

8600 R/611

Assortiment de 52 sangles de levage avec grilles, sans panneau



8600 R/611 CHF 1,240.00 1 086000611
C88/R611 233.00 1 088000161

Beta



CHAUSSURES DE PROTECTION

AVERTISSEMENTS

Avant l'emploi, vérifier que les chaussures correspondent aux exigences d'utilisation et que la catégorie de protection soit correcte en fonction du type et du lieu de travail. Les chaussures fabriquées par Beta Utensili sont conformes aux NORMES EUROPÉENNES en vigueur. La loi responsabilise l'employeur quant à la conformité des EPI par rapport au type de risque présent (caractéristiques des EPI et catégorie d'appartenance).

OBSOLESCENCE

En raison de nombreux facteurs (humidité lors du stockage et modification de la structure des matériaux dans le temps), il n'est pas possible d'établir avec certitude la durée de stockage de la chaussure. En général, pour les chaussures entièrement en polyuréthane ou avec un fond en polyuréthane, une durée maximale de trois ans à compter de la date de fabrication peut être supposée. Pour les chaussures entièrement en PVC, une durée de cinq ans à compter de la date de fabrication peut être supposée, tandis que pour les chaussures à tige en cuir, les chaussures en caoutchouc, en matière thermoplastique et en EVA, une durée maximale de dix ans à compter de la date de fabrication peut être envisagée. Ce délai fait référence à des chaussures neuves, emballées et stockées dans des conditions contrôlées, évitant les fortes différences de température et d'humidité relative.

NORMES EUROPÉENNES ET SIGNIFICATION EN ISO 20345:2011 - EN ISO 20347:2012

CONFORMITÉ À LA NORME EN ISO 20345:2011

La norme spécifie les exigences fondamentales et additionnelles (optionnelles) pour les chaussures de sécurité d'usage général. Les chaussures conformes à la norme EN ISO 20345:2011 sont marquées de la lettre "S" (Safety = Sécurité) dont l'embout peut résister à 200 Joules.

CONFORMITÉ À LA NORME EN ISO 20347:2012

La norme spécifie les exigences fondamentales et additionnelles (facultatives) relatives aux chaussures de travail qui n'exigent pas de protection contre les risques mécaniques (choc ou écrasement). Les chaussures conformes à la norme EN ISO 20347:2012 portent la lettre "O" (Occupational = Professionnel). Leurs caractéristiques sont semblables à celles des chaussures précédemment indiquées, les seules différences sont l'absence de l'embout de protection et de la semelle anti-perforation.

En sus des exigences fondamentales obligatoires au sens de la norme EN ISO 20345:2011, les chaussures peuvent également répondre à des exigences additionnelles. Ces exigences doivent être identifiées par des symboles ou classes et reportées sur l'étiquette apposée sur la languette de la chaussure.

NORMES EUROPÉENNES ET SIGNIFICATION EN ISO 20345:2022 - EN ISO 20347:2022

CONFORMITÉ À LA NORME EN ISO 20345:2022

La norme spécifie les exigences fondamentales et additionnelles (optionnelles) pour les chaussures de sécurité d'usage général. Les chaussures conformes à la norme EN ISO 20345:2011 sont marquées de la lettre "S" (Safety = Sécurité) dont l'embout peut résister à 200 Joules.

CONFORMITÉ À LA NORME EN ISO 20347:2022

La norme spécifie les exigences fondamentales et additionnelles (facultatives) relatives aux chaussures de travail qui n'exigent pas de protection contre les risques mécaniques (choc ou écrasement). Les chaussures conformes à la norme EN ISO 20347:2012 portent la lettre "O" (Occupational = Professionnel). Leurs caractéristiques sont semblables à celles des chaussures précédemment indiquées, les seules différences sont l'absence de l'embout de protection et de la semelle anti-perforation.

En sus des exigences fondamentales obligatoires au sens de la norme EN ISO 20345:2011, les chaussures peuvent également répondre à des exigences additionnelles. Ces exigences doivent être identifiées par des symboles ou classes et reportées sur l'étiquette apposée sur la languette de la chaussure.

Informations pour les chaussures avec insert anti-perforation

La résistance à la perforation de cette chaussure a été mesurée en laboratoire à l'aide de pointes et de force standardisés. Des pointes de plus petit diamètre et des charges statiques ou dynamiques plus élevées augmentent le risque de perforation. Dans de telles circonstances, des mesures préventives supplémentaires doivent être envisagées. Trois types différents d'inserts résistants à la perforation sont actuellement disponibles pour les chaussures EPI. Il peut s'agir d'inserts métalliques et non métalliques, à choisir sur la base d'une évaluation des risques liés au type de travail. Tous les inserts offrent une protection contre le risque de perforation, mais chacun d'entre eux présente plusieurs avantages ou inconvénients supplémentaires, en particulier :

- Insert anti-perforation métallique : la résistance à la perforation est moins concernée par la forme de l'objet coupant (par exemple le diamètre, la géométrie ou la forme pointue), mais en raison des limitations des dimensions nécessaires à la production de la chaussure, la résistance ne couvre pas toute la surface de la partie inférieure de la chaussure.
- Insert anti-perforation non métallique (PL) : il peut être plus léger, plus flexible et offrir une plus grande surface de couverture par rapport au métal, mais la résistance à la perforation peut varier davantage en fonction de la forme de l'objet coupant (par exemple le diamètre, la géométrie ou forme pointue).

EXIGENCES FONDAMENTALES + EXIGENCES ADDITIONNELLES DES CHAUSSURES

CLASSIFICATION

I = Chaussures en cuir et autres matériaux, à l'exception du caoutchouc ou matériau polymère

II = Chaussures entièrement en caoutchouc ou entièrement polymère (bottes)

EXIGENCES DE BASE

- **Chaussure complète** : hauteur de la tige ; zone du talon ; performances de fabrication de la semelle (fabrication et résistance au décollement de la tige/semelle) ; caractéristiques de protection des doigts de pied et de l'embout (sauf EN ISO 20347), propriétés antidérapantes.
- **Tige** : caractéristiques des matériaux de la tige, doublure, languette, première de propreté (résistance à la déchirure, à l'abrasion, caractéristiques de traction, perméabilité à la vapeur d'eau, pH, absorption et désorption pour la première de propreté et la semelle intérieure).
- **Semelle** : construction et résistance à la déchirure, à l'abrasion, à la flexion, à l'hydrolyse, au décollement des semelles et aux huiles hydrocarbonées.

CLASSE DE PROTECTION		EN ISO 20345:2011				EN ISO 20347:2012				EN ISO 20345:2011		EN ISO 20347:2012		VALEURS MINIMALES REQUISES
		SB	S1	S2	S3	OB	O1	O2	O3	S4	S5	O4	O5	
	Zone du talon fermée	0	X	X	X	0	X	X	X	X	X	X	X	
	Résistance au choc de l'embout 200 Joules	X	X	X	X	-	-	-	-	X	X	-	-	
A	Chaussures antistatiques	0	X	X	X	0	X	X	X	X	X	X	X	Résistance électrique > 100 kΩ, ≤ 1000 MΩ
E	Absorption d'énergie dans la zone du talon	0	X	X	X	0	X	X	X	X	X	X	X	> 20 Joules
WRU	Tige résistante à la pénétration et à l'absorption d'eau	0	-	X	X	0	-	X	X	-	-	-	-	Pénétration: < 0,2 g x 60 mn Absorption : < 30% x 60 mn
P	Résistance de la semelle à la perforation	0	0	-	X	0	0	-	X	0	X	0	X	> 1100 N
CI	Isolation contre le froid	0	0	0	0	0	0	0	0	0	0	0	0	Réduction temp. surface interne semelle : < 10° C
HI	Isolation contre la chaleur	0	0	0	0	0	0	0	0	0	0	0	0	Augmentation temp. surface interne semelle : < 22° C
HRO	Résistance de la semelle à la chaleur par contact	0	0	0	0	0	0	0	0	0	0	0	0	Résistant jusqu'à 300 °C
WR	Chaussure résistante à l'eau	0	0	0	0	0	0	0	0	-	-	-	-	Absorption : < 3 cm ²
FO	Résistance de la semelle aux hydrocarbures	0	X	X	X	0	0	0	0	X	X	0	0	Augmentation du volume de la semelle < 12 %
SRC	Résistance de la semelle à la glisse	X	X	X	X	X	X	X	X					Exigence SRA + SRB

X	Exigence obligatoire de la catégorie de protection
O	Exigence facultative associée aux exigences obligatoires, si indiqué par le marquage
-	Exigence non obligatoire , contrôler le marquage de la chaussure

Chaussures antistatiques :

Les chaussures antistatiques doivent être utilisées en cas de nécessité de réduire au minimum l'accumulation de charges électrostatiques de sorte à exclure le risque de combustion de substances inflammables et de vapeurs et si persiste le risque de secousses électriques provenant d'éléments sous tension. Les chaussures antistatiques ne protègent pas contre le choc électrique car elles procurent uniquement une résistance électrique entre le sol et le pied. Si les risques de choc électrique ne peuvent pas être complètement exclus, il sera nécessaire d'adopter des précautions supplémentaires à planifier selon un programme périodique de prévention des accidents du travail. Afin de préserver les propriétés antistatiques, les chaussures ne devront pas subir de modifications.

Chaussures isolantes contre le risque électrique

Les chaussures isolantes contre le risque électrique apportent une protection électrique contre les contacts accidentels jusqu'à 1000 V sous réserve que les conditions d'utilisation ne devront pas modifier ou altérer la résistance électrique avec l'influence de l'humidité. Il est précisé que la résistance électrique se réfère uniquement au fond de la chaussure et non pas à la tige.

Classes électriques des chaussures :

Classe 00 500V CA ou 750V CC

Classe 0 1000V CA ou 1500V CC

Chaussures dissipatives pour les milieux EPA :

Les chaussures dissipatives sont conçues pour les milieux EPA (ESDS) et permettent aux charges électrostatiques présentes sur le corps d'être dissipées de manière continue et contrôlée, de sorte à protéger les composants et les dispositifs électroniques contre les phénomènes électrostatiques. La valeur de référence de la résistance au sol selon CEI EN 61340-5-1: 2016, pour la personne qui la porte / chaussures / sol, se situe entre < 1 × 10⁹ Ω.

EXIGENCES FONDAMENTALES + EXIGENCES ADDITIONNELLES DES CHAUSSURES

CLASSIFICATION

I = Chaussures en cuir et autres matériaux, à l'exception du caoutchouc ou matériau polymère

II = Chaussures entièrement en caoutchouc ou entièrement polymère (bottes)

EXIGENCES DE BASE

- **Chaussure complète** : hauteur de la tige ; zone du talon ; performances de fabrication de la semelle (fabrication et résistance au décollement de la tige/semelle) ; caractéristiques de protection des doigts de pied et de l'embout (sauf EN ISO 20347), propriétés antidérapantes.
- **Tige** : caractéristiques des matériaux de la tige, doublure, languette, première de propreté (résistance à la déchirure, à l'abrasion, caractéristiques de traction, perméabilité à la vapeur d'eau, pH, absorption et désorption pour la première de propreté et la semelle intérieure).
- **Semelle** : construction et résistance à la déchirure, à l'abrasion, à la flexion, à l'hydrolyse, au décollement des semelles et aux huiles hydrocarbonées.

CLASSE DE PROTECTION	EN ISO 20345:2022											EN ISO 20347:2022					VALEURS MINIMALES REQUISES
	SB	S1	S2	S3	S3L	S3S	S6	S7	S7L	S7S	OB	O1	O2	O3	O3L	O3S	
Classe	I o II	I	I	I	I	I	I	I	I	I	I o II	I	I	I	I	I	
Zone du talon fermée	0	X	X	X	X	X	X	X	X	X	0	X	X	X	X	X	
Résistance aux chocs de l'embout 200 Joules	X	X	X	X	X	X	X	X	X	X	-	-	-	-	-	-	
Semelle crantée	0	0	0	X	X	X	0	X	X	X	0	0	0	X	X	X	
P Résistance de la semelle à la perforation (avec un embout métallique P)	0	0	0	X	-	-	0	X	-	-	0	0	0	X	-	-	Force de perforation ≥ 1100 N
PL Résistance de la semelle à la perforation (embout non métallique, test avec pointe large Ø 4,5 mm)	0	0	0	-	X	-	0	-	X	-	0	0	0	-	X	-	
PS Résistance de la semelle à la perforation (embout non métallique, test avec pointe fine Ø 3,0 mm)	0	0	0	-	-	X	0	-	-	X	0	0	0	-	-	X	
A Chaussures antistatiques	0	X	X	X	X	X	X	X	X	X	0	X	X	X	X	X	Résistance électrique > 100 kΩ ≤ 1000 kΩ
HI Isolation thermique contre la chaleur continue de l'ensemble de la semelle intérieure	0	0	0	0	0	0	0	0	0	0	0	0	0	0	0	0	Augmentation T ≤ 22 °C en cas de positionnement sur une plaque avec T de 150 °C pendant 30'
CI Isolation thermique contre le froid de l'ensemble de la semelle intérieure	0	0	0	0	0	0	0	0	0	0	0	0	0	0	0	0	Diminution T ≤ 10 °C en environnement à -17 °C pendant 30'
E Absorption d'énergie dans la zone du talon	0	X	X	X	X	X	X	X	X	X	0	X	X	X	X	X	> 20 Joules
WR Résistance à l'eau	0	0	0	0	0	0	X	X	X	X	0	0	0	0	0	0	Aucune pénétration de l'eau
SC Résistance à l'abrasion des paires-pierres	0	0	0	0	0	0	0	0	0	0	0	0	0	0	0	0	Aucun trou sur toute l'épaisseur après 8.000 cycles
SR Résistance au glissement sur sol en céramique avec glycérine	X	X	X	X	X	X	X	X	X	X	X	X	X	X	X	X	Test sur sol en céramique avec glycérine.
WPA Résistance à l'eau des matériaux de la tige	0	0	X	X	X	X	-	-	-	-	0	0	X	X	X	X	Absorption de l'eau après 60' ≤ 30 %
HRO Résistance à la chaleur de la semelle extérieure	0	0	0	0	0	0	0	0	0	0	0	0	0	0	0	0	Contact à 300 °C pendant 60'' - ne fond pas
FO Résistance aux hydrocarbures	0	0	0	0	0	0	0	0	0	0	0	0	0	0	0	0	Augmentation du volume de l'échantillon de semelle < 12 %
LG Adhérence de grip talon décroché	0	0	0	0	0	0	0	0	0	0	0	0	0	0	0	0	Largeur de la zone centrale de la semelle > 35 mm

	Exigence obligatoire de la catégorie de protection
	Exigence facultative associée aux exigences obligatoires, si indiqué par le marquage
	Exigence non obligatoire , contrôler le marquage de la chaussure

Chaussures partiellement conductrices

Des chaussures partiellement conductrices doivent être utilisées s'il est nécessaire de minimiser les charges électrostatiques dans les plus brefs délais, par exemple lors de la manipulation d'explosifs.

Elles ne doivent pas être utilisées si le risque d'électrocution d'équipements électriques ou de pièces sous tension à tension alternative ou continue n'a pas été complètement éliminé. Pour s'assurer que cette chaussure est partiellement conductrice, il est indiqué que la limite supérieure de résistance est de 100 kΩ à l'état neuf.

Chaussures antistatiques :

Les chaussures antistatiques doivent être utilisées en cas de nécessité de réduire au minimum l'accumulation de charges électrostatiques de sorte à exclure le risque de combustion de substances inflammables et de vapeurs et si persiste le risque de secousses électriques provenant d'éléments sous tension. Les chaussures antistatiques ne protègent pas contre le choc électrique car elles procurent uniquement une résistance électrique entre le sol et le pied. Si les risques de choc électrique ne peuvent pas être complètement exclus, il sera nécessaire d'adopter des précautions supplémentaires à planifier selon un programme périodique de prévention des accidents du travail. Afin de préserver les propriétés antistatiques, les chaussures ne devront pas subir de modifications.

NB Toutes les chaussures certifiées avec les anciennes normes maintiennent la validité du certificat jusqu'à son échéance.

EN ISO 20345:2011 S1P SRC

LIGNE	ARTICLE	CONDITIONS REQUISES				SECTEURS PRÉCONISÉS						📄
		CONDITIONS REQUISES SUPPLÉMENTAIRES				SECTEUR AUTOMOBILE	CONSTRUCTION EN BÂTIMENT		ÉLECTRICITÉ	INDUSTRIE	LOGISTIQUE SERVICES	
	7210BKK				X	X	X	X	X	X	X	596
	7216BKK				X	X	X	X	X	X	X	597
	7212G	ESD			X	X		X	X	X	X	593
	7212B	ESD										593
	7213G	ESD			X	X		X	X	X	X	593
	7212LG				X	X		X	X	X	X	593
	7222PEK				X	X	X	X	X	X	X	591
	7223PEK				X	X	X	X	X	X	X	592
	7224PEK				X	X	X	X	X	X	X	592
	7225PEK				X	X	X	X	X	X	X	592
	7241BK				X	X		X	X	X		588
	7243BK				X	X		X		X		588
	7246BK				X	X		X	X	X		590
	7247BK				X	X		X	X	X		590
	7246E					X		X	X	X		587
	7248GK					X		X	X	X		598
	7249GK	RS				X		X		X		598
	7314AF				X	X	X	X	X	X	X	599
	7316NB	ESD			X	X	X	X	X	X	X	600
	7316NG	ESD			X	X	X	X	X	X	X	600
	7317NA				X	X	X	X	X	X	X	600
	7340B					X		X	X	X		607
	7352A	HRO			X	X		X	X	X	X	602
	7352B	HRO			X	X		X	X	X	X	602
	7352G	HRO ESD	X		X	X		X	X	X	X	602
	7353Y	HRO				X		X	X	X	X	603
	7372B	HRO	X		X	X		X	X	X	X	606
	7376A	HRO	X		X	X		X	X	X	X	606
	7352LG	HRO			X	X		X	X	X	X	603

EN ISO 20347:2012 O1 SRC

LIGNE	ARTICLE	CONDITIONS REQUISES	SECTEURS PRÉCONISÉS	📄
	7362B	FO HRO	X X X X	605

EN ISO 20347:2012 O2 SRC

LIGNE	ARTICLE	CONDITIONS REQUISES	SECTEURS PRÉCONISÉS	📄
	7243FT	FO	X X	589
	7363N	FO HRO	X X X X	605

EN ISO 20345:2011 S3 SRC

LIGNE	ARTICLE	CONDITIONS REQUISES				SECTEURS PRÉCONISÉS						📄	
		CONDITIONS REQUISES SUPPLÉMENTAIRES				AGRICULTURE	SECTEUR AUTOMOBILE	CONSTRUCTION EN BÂTIMENT		INDUSTRIE	ÉLECTRICITÉ		LOGISTIQUE SERVICES
	7200BKK				X	X	X	X	X	X	X	X	596
	7201BKK				X	X	X	X	X	X	X	X	596
	7310CRK	RS HRO				X	X	X	X			X	597
	7214FN				X	X		X	X	X	X	X	594
	7214G	ESD			X	X		X	X	X	X	X	594
	7215FN				X	X		X	X	X	X	X	595
	7218FN	RS			X	X		X	X	X	X	X	595
	7218G	RS ESD			X	X		X	X	X	X	X	595
	7214LN				X	X		X	X	X	X	X	594
	7220PEK				X	X	X	X	X	X	X	X	591
	7221PEK	RS			X	X	X	X	X	X	X	X	591
	7235BK					X	X	X		X	X	X	597
	7236BK	RS				X	X	X				X	598
	7238WR	RS HRO WR				X	X	X				X	598
	7239B					X	X	X				X	598
	7241EN					X	X	X		X	X	X	587
	7243EN	RS				X	X	X				X	587
	7241CK					X	X	X	X	X	X	X	588
	7243CK	RS				X	X	X	X			X	589
	7243CR	RS HRO				X	X	X	X		X	X	589
	7245BK	RS				X	X	X	X			X	589
	7293HM	HRO HI	X			X	X				X	X	608
	7293HN	HRO HI	X			X	X				X	X	608
	7294HM	HRO HI	X			X	X				X	X	609
	7294HMC	HRO HI CI WR	X			X	X				X	X	609
	7294HN	RS HRO HI	X			X	X				X	X	609
	7315AN				X	X	X	X	X	X	X	X	599
	7318AN				X	X	X	X	X	X	X	X	600
	7320NA				X	X	X	X	X	X	X	X	601
	7321NA	RS			X	X	X	X	X	X	X	X	601
	7322SA				X	X	X	X	X	X	X	X	601
	7323SA	RS			X	X	X	X	X	X	X	X	601
	7341N					X	X	X	X	X	X	X	607
	7349RP	HRO			X	X	X	X	X	X	X	X	607
	7350RP	HRO			X	X	X	X	X	X	X	X	608
	7354N	HRO			X	X	X	X	X	X	X	X	603
	7355V	HRO			X	X	X	X	X	X	X	X	603
	7356G	HRO			X	X	X	X	X	X	X	X	604
	7357G	HRO			X	X	X	X	X	X	X	X	604
	7356V	HRO			X	X	X	X	X	X	X	X	604
	7357V	HRO			X	X	X	X	X	X	X	X	605
	7356LN	HRO			X	X	X	X	X	X	X	X	604
	7381N	HRO WR	X		X	X	X	X	X	X	X	X	606
	7382N	HRO WR	X		X	X	X	X	X	X	X	X	606

EN ISO 20345:2011 S5 SRC

LIGNE	ARTICLE	CONDITIONS REQUISES	SECTEURS PRÉCONISÉS	📄
	7328A		X X X	590
	7328N		X X X	590

EASY



7241EN

Chaussure basse en cuir pigmenté hydrofuge

- Embout en acier
- Semelle anti-perforation en acier souple

**EN ISO
20345
2011**



EU	UK	mm	CHF		
35	2,5	230	52.00	1	072410835
36	3,5	237	52.00	1	072410836
37	4,5	244	52.00	1	072410837
38	5	250	52.00	1	072410838
39	6	257	52.00	1	072410839
40	6,5	264	52.00	1	072410840
41	7	270	52.00	1	072410841
42	8	277	52.00	1	072410842
43	9	284	52.00	1	072410843
44	10	290	52.00	1	072410844
45	10,5	297	52.00	1	072410845
46	11	304	52.00	1	072410846
47	12	310	52.00	1	072410847
48	13	317	52.00	1	072410848



CE

S3 SRC

7243EN

Chaussure montante en cuir pigmenté hydrofuge, délaçage rapide

- Embout en acier
- Semelle anti-perforation en acier souple

**EN ISO
20345
2011**



EU	UK	mm	CHF		
35	2,5	230	53.50	1	072430835
36	3,5	237	53.50	1	072430836
37	4,5	244	53.50	1	072430837
38	5	250	53.50	1	072430838
39	6	257	53.50	1	072430839
40	6,5	264	53.50	1	072430840
41	7	270	53.50	1	072430841
42	8	277	53.50	1	072430842
43	9	284	53.50	1	072430843
44	10	290	53.50	1	072430844
45	10,5	297	53.50	1	072430845
46	11	304	53.50	1	072430846
47	12	310	53.50	1	072430847
48	13	317	53.50	1	072430848



CE

S3 RS SRC

7246E

Chaussure basse type tennis aérée en croûte de velours

- Embout en acier
- Semelle anti-perforation en acier souple

**EN ISO
20345
2011**



EU	UK	mm	CHF		
35	2,5	230	53.50	1	072460435
36	3,5	237	53.50	1	072460436
37	4,5	244	53.50	1	072460437
38	5	250	53.50	1	072460438
39	6	257	53.50	1	072460439
40	6,5	264	53.50	1	072460440
41	7	270	53.50	1	072460441
42	8	277	53.50	1	072460442
43	9	284	53.50	1	072460443
44	10	290	53.50	1	072460444
45	10,5	297	53.50	1	072460445
46	11	304	53.50	1	072460446
47	12	310	53.50	1	072460447
48	13	317	53.50	1	072460448



CE

S1P SRC

BASIC



7241BK
Chaussure basse en cuir pigmenté

- Embout en acier
- Semelle anti-perforation en fibre composite

**EN ISO
20345
2011**

EU	UK	mm	CHF		
35	2,5	228	62.50	1	072411235
36	3,5	235	62.50	1	072411236
37	4,5	242	62.50	1	072411237
38	5	248	62.50	1	072411238
39	6	255	62.50	1	072411239
40	6,5	262	62.50	1	072411240
41	7	268	62.50	1	072411241
42	8	275	62.50	1	072411242
43	9	282	62.50	1	072411243
44	10	288	62.50	1	072411244
45	10,5	295	62.50	1	072411245
46	11	302	62.50	1	072411246
47	12	308	62.50	1	072411247
48	13	315	62.50	1	072411248



CE

S1P SRC



7241CK
Chaussure basse en cuir pigmenté hydrofuge

- Embout en acier
- Semelle anti-perforation en fibre composite

**EN ISO
20345
2011**

EU	UK	mm	CHF		
35	2,5	228	63.50	1	072411535
36	3,5	235	63.50	1	072411536
37	4,5	242	63.50	1	072411537
38	5	248	63.50	1	072411538
39	6	255	63.50	1	072411539
40	6,5	262	63.50	1	072411540
41	7	268	63.50	1	072411541
42	8	275	63.50	1	072411542
43	9	282	63.50	1	072411543
44	10	288	63.50	1	072411544
45	10,5	295	63.50	1	072411545
46	11	302	63.50	1	072411546
47	12	308	63.50	1	072411547
48	13	315	63.50	1	072411548



CE

S3 SRC



7243BK
Chaussure montante en cuir pigmenté

- Embout en acier
- Semelle anti-perforation en fibre composite

**EN ISO
20345
2011**

EU	UK	mm	CHF		
35	2,5	228	63.50	1	072431235
36	3,5	235	63.50	1	072431236
37	4,5	242	63.50	1	072431237
38	5	248	63.50	1	072431238
39	6	255	63.50	1	072431239
40	6,5	262	63.50	1	072431240
41	7	268	63.50	1	072431241
42	8	275	63.50	1	072431242
43	9	282	63.50	1	072431243
44	10	288	63.50	1	072431244
45	10,5	295	63.50	1	072431245
46	11	302	63.50	1	072431246
47	12	308	63.50	1	072431247
48	13	315	63.50	1	072431248



CE

S1P SRC



7243CK

Chaussure montante en cuir pigmenté hydrofuge, délaçage rapide

- Embout en acier
- Semelle anti-perforation en fibre composite

EU	UK	mm	CHF		
35	2,5	228	65.50	1	072431335
36	3,5	235	65.50	1	072431336
37	4,5	242	65.50	1	072431337
38	5	248	65.50	1	072431338
39	6	255	65.50	1	072431339
40	6,5	262	65.50	1	072431340
41	7	268	65.50	1	072431341
42	8	275	65.50	1	072431342
43	9	282	65.50	1	072431343
44	10	288	65.50	1	072431344
45	10,5	295	65.50	1	072431345
46	11	302	65.50	1	072431346
47	12	308	65.50	1	072431347
48	13	315	65.50	1	072431348

CE



S3 RS SRC

EN ISO 20345 2011



7243CR

Chaussure montante type Brodequin en cuir pigmenté hydrofuge avec semelle en caoutchouc haute résistance, délaçage rapide

- Embout en acier
- Semelle anti-perforation en acier souple

EU	UK	mm	CHF		
35	2,5	231	97.00	1	072430735
36	3,5	238	97.00	1	072430736
37	4,5	245	97.00	1	072430737
38	5	251	97.00	1	072430738
39	6	258	97.00	1	072430739
40	6,5	265	97.00	1	072430740
41	7	271	97.00	1	072430741
42	8	278	97.00	1	072430742
43	9	285	97.00	1	072430743
44	10	291	97.00	1	072430744
45	10,5	298	97.00	1	072430745
46	11	305	97.00	1	072430746
47	12	311	97.00	1	072430747
48	13	318	97.00	1	072430748

CE



S3 RS HRO SRC

EN ISO 20345 2011



7243FT

Chaussure montante type Brodequin en cuir pigmenté hydrofuge sans embout ni semelle anti-perforation

- Sans embout
- Sans semelle anti-perforation

EU	UK	mm	CHF		
35	2,5	228	57.00	1	072430635
36	3,5	235	57.00	1	072430636
37	4,5	242	57.00	1	072430637
38	5	248	57.00	1	072430638
39	6	255	57.00	1	072430639
40	6,5	262	57.00	1	072430640
41	7	268	57.00	1	072430641
42	8	275	57.00	1	072430642
43	9	282	57.00	1	072430643
44	10	288	57.00	1	072430644
45	10,5	295	57.00	1	072430645
46	11	302	57.00	1	072430646
47	12	308	57.00	1	072430647
48	13	315	57.00	1	072430648

CE



O2 FO SRC

EN ISO 20347 2012



7245BK

Chaussure montante type "soudeur" à lacets en cuir pleine fleur pigmenté hydrofuge, délaçage rapide, protection frontale avec languette d'ouverture rapide type "scratch"

- Embout en acier
- Semelle anti-perforation en fibre composite

EU	UK	mm	CHF		
35	2,5	228	75.50	1	072451235
36	3,5	235	75.50	1	072451236
37	4,5	242	75.50	1	072451237
38	5	248	75.50	1	072451238
39	6	255	75.50	1	072451239
40	6,5	262	75.50	1	072451240
41	7	268	75.50	1	072451241
42	8	275	75.50	1	072451242
43	9	282	75.50	1	072451243
44	10	288	75.50	1	072451244
45	10,5	295	75.50	1	072451245
46	11	302	75.50	1	072451246
47	12	308	75.50	1	072451247
48	13	315	75.50	1	072451248

CE



S3 RS SRC

EN ISO 20345 2011



7246BK

Chaussure basse type tennis aérée en croûte de velours

- Embout en acier
- Semelle anti-perforation en fibre composite

EU	UK	mm	CHF		
35	2,5	228	65.50	1	072461235
36	3,5	235	65.50	1	072461236
37	4,5	242	65.50	1	072461237
38	5	248	65.50	1	072461238
39	6	255	65.50	1	072461239
40	6,5	262	65.50	1	072461240
41	7	268	65.50	1	072461241
42	8	275	65.50	1	072461242
43	9	282	65.50	1	072461243
44	10	288	65.50	1	072461244
45	10,5	295	65.50	1	072461245
46	11	302	65.50	1	072461246
47	12	308	65.50	1	072461247
48	13	315	65.50	1	072461248



CE

S1P SRC

**EN ISO
20345
2011**



7247BK

Chaussure basse type sandale aérée en cuir pigmenté

- Embout en acier
- Semelle anti-perforation en fibre composite

EU	UK	mm	CHF		
35	2,5	228	65.00	1	072471235
36	3,5	235	65.00	1	072471236
37	4,5	242	65.00	1	072471237
38	5	248	65.00	1	072471238
39	6	255	65.00	1	072471239
40	6,5	262	65.00	1	072471240
41	7	268	65.00	1	072471241
42	8	275	65.00	1	072471242
43	9	282	65.00	1	072471243
44	10	288	65.00	1	072471244
45	10,5	295	65.00	1	072471245
46	11	302	65.00	1	072471246
47	12	308	65.00	1	072471247
48	13	315	65.00	1	072471248



CE

S1P SRC

**EN ISO
20345
2011**



7328A

Botte de sécurité "haute visibilité" en PVC nitrile. Avec semelle extérieure antidérapante autonettoyante.

- Embout en acier
- Semelle anti-perforation en acier souple

EU	UK	mm	CHF		
38	5	253	51.50	1	073280638
39	6	260	51.50	1	073280639
40	6,5	267	51.50	1	073280640
41	7	273	51.50	1	073280641
42	8	280	51.50	1	073280642
43	9	287	51.50	1	073280643
44	10	293	51.50	1	073280644
45	10,5	300	51.50	1	073280645
46	11	307	51.50	1	073280646
47	12	313	51.50	1	073280647



CE

S5 SRC

**EN ISO
20345
2011**



7328N

Botte de sécurité en PVC nitrile. Avec semelle extérieure antidérapante autonettoyante.

- Embout en acier
- Semelle anti-perforation en acier souple

EU	UK	mm	CHF		
38	5	253	51.50	1	073280838
39	6	260	51.50	1	073280839
40	6,5	267	51.50	1	073280840
41	7	273	51.50	1	073280841
42	8	280	51.50	1	073280842
43	9	287	51.50	1	073280843
44	10	293	51.50	1	073280844
45	10,5	300	51.50	1	073280845
46	11	307	51.50	1	073280846
47	12	313	51.50	1	073280847



CE

S5 SRC

**EN ISO
20345
2011**



EASY PLUS



7220PEK

Chaussure basse en cuir pigmenté hydrofuge avec inserts en nylon et couvre-embout anti-abrasion

- Embout en composite
- Semelle anti-perforation en fibre composite

**EN ISO
20345
2011**

METAL
FREE



EU	UK	mm	CHF		
35	2,5	228	86.50	1	072200235
36	3,5	235	86.50	1	072200236
37	4,5	242	86.50	1	072200237
38	5	248	86.50	1	072200238
39	6	255	86.50	1	072200239
40	6,5	262	86.50	1	072200240
41	7	268	86.50	1	072200241
42	8	275	86.50	1	072200242
43	9	282	86.50	1	072200243
44	10	288	86.50	1	072200244
45	10,5	295	86.50	1	072200245
46	11	302	86.50	1	072200246
47	12	308	86.50	1	072200247
48	13	315	86.50	1	072200248

CE



S3 SRC

7221PEK

Chaussure montante en cuir pigmenté hydrofuge avec inserts en nylon, couvre-embout anti-abrasion, délaçage rapide

- Embout en composite
- Semelle anti-perforation en fibre composite

**EN ISO
20345
2011**

METAL
FREE



EU	UK	mm	CHF		
35	2,5	228	90.50	1	072210235
36	3,5	235	90.50	1	072210236
37	4,5	242	90.50	1	072210237
38	5	248	90.50	1	072210238
39	6	255	90.50	1	072210239
40	6,5	262	90.50	1	072210240
41	7	268	90.50	1	072210241
42	8	275	90.50	1	072210242
43	9	282	90.50	1	072210243
44	10	288	90.50	1	072210244
45	10,5	295	90.50	1	072210245
46	11	302	90.50	1	072210246
47	12	308	90.50	1	072210247
48	13	315	90.50	1	072210248

CE



S3 RS SRC

7222PEK

Chaussure basse en daim perforée grise , avec empiècements en mesh hautement respirant -S1P SRC

- Embout composite
- Semelle antiperforation en fibre composite

**EN ISO
20345
2011**

METAL
FREE



EU	UK	mm	CHF		
35	2,5	228	83.00	1	072220135
36	3,5	235	83.00	1	072220136
37	4,5	242	83.00	1	072220137
38	5	248	83.00	1	072220138
39	6	255	83.00	1	072220139
40	6,5	262	83.00	1	072220140
41	7	268	83.00	1	072220141
42	8	275	83.00	1	072220142
43	9	282	83.00	1	072220143
44	10	288	83.00	1	072220144
45	10,5	295	83.00	1	072220145
46	11	302	83.00	1	072220146
47	12	308	83.00	1	072220147
48	13	315	83.00	1	072220148

CE



S1P SRC

7223PEK

Chaussure basse en croûte de velours avec inserts en maille à ventilation élevée et couvre-embout anti-abrasion

- Embout en composite
- Semelle anti-perforation en fibre composite

EN ISO 20345 2011

EU	UK	mm	CHF		
35	2,5	228	89.50	1	072230135
36	3,5	235	89.50	1	072230136
37	4,5	242	89.50	1	072230137
38	5	248	89.50	1	072230138
39	6	255	89.50	1	072230139
40	6,5	262	89.50	1	072230140
41	7	268	89.50	1	072230141
42	8	275	89.50	1	072230142
43	9	282	89.50	1	072230143
44	10	288	89.50	1	072230144
45	10,5	295	89.50	1	072230145
46	11	302	89.50	1	072230146
47	12	308	89.50	1	072230147
48	13	315	89.50	1	072230148



CE

S1P SRC



7224PEK

Chaussure basse type tennis aérée en croûte de velours avec couvre-embout anti-abrasion

- Embout en composite
- Semelle anti-perforation en fibre composite

EN ISO 20345 2011

EU	UK	mm	CHF		
35	2,5	228	89.50	1	072240235
36	3,5	235	89.50	1	072240236
37	4,5	242	89.50	1	072240237
38	5	248	89.50	1	072240238
39	6	255	89.50	1	072240239
40	6,5	262	89.50	1	072240240
41	7	268	89.50	1	072240241
42	8	275	89.50	1	072240242
43	9	282	89.50	1	072240243
44	10	288	89.50	1	072240244
45	10,5	295	89.50	1	072240245
46	11	302	89.50	1	072240246
47	12	308	89.50	1	072240247
48	13	315	89.50	1	072240248



CE

S1P SRC



7225PEK

Chaussure basse en daim perforée bleue , avec empiècements en mesh hautement respirant -S1P SRC

- Embout composite
- Semelle antiperforation en fibre composite

EN ISO 20345 2011

EU	UK	mm	CHF		
35	2,5	228	86.00	1	072250135
36	3,5	235	86.00	1	072250136
37	4,5	242	86.00	1	072250137
38	5	248	86.00	1	072250138
39	6	255	86.00	1	072250139
40	6,5	262	86.00	1	072250140
41	7	268	86.00	1	072250141
42	8	275	86.00	1	072250142
43	9	282	86.00	1	072250143
44	10	288	86.00	1	072250144
45	10,5	295	86.00	1	072250145
46	11	302	86.00	1	072250146
47	12	308	86.00	1	072250147
48	13	315	86.00	1	072250148



CE

S1P SRC

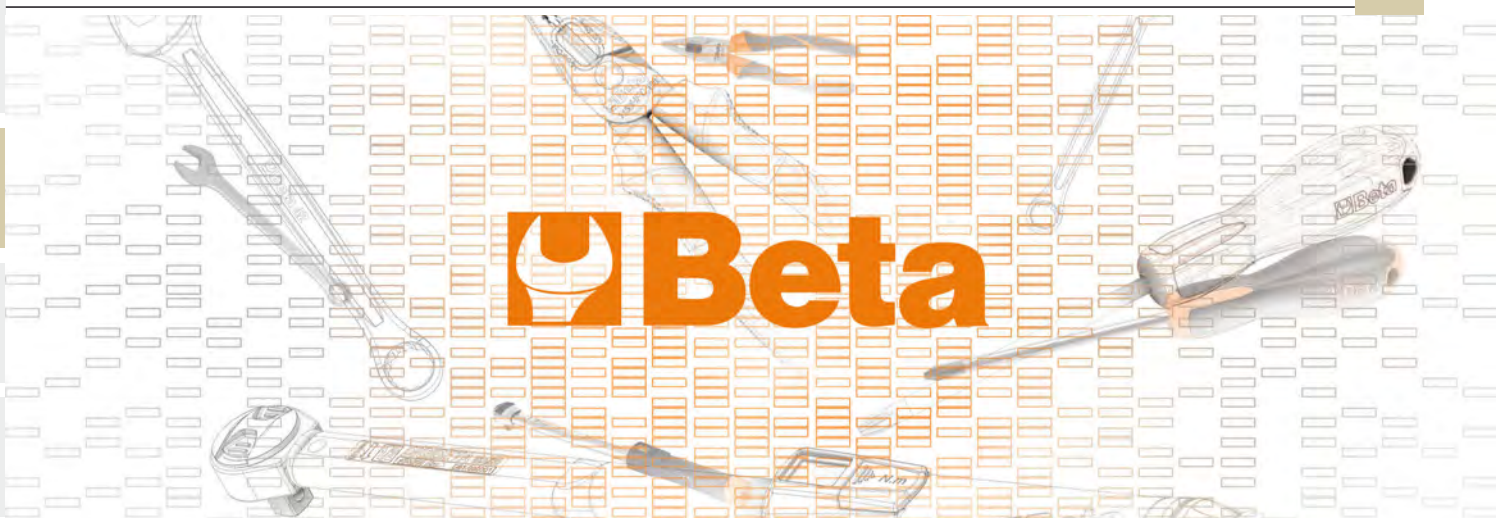

FLEX



7212B

Chaussure basse en croûte de velours aérée avec inserts en tissu mesh. Avec insert anti-abrasion sur l'embout Extrêmement flexible et légère - Poids approximatif pour la taille 42: 490 g Non indiquée pour des utilisations contraignantes (bâtiment, agriculture, industrie lourde)

- Embout en composite
- Semelle anti-perforation en fibre composite

EU	UK	mm	CHF		
35	2.5	228	96.00	1	072120235
36	3.5	235	96.00	1	072120236
37	4.5	242	96.00	1	072120237
38	5	248	96.00	1	072120238
39	6	255	96.00	1	072120239
40	6.5	262	96.00	1	072120240
41	7	268	96.00	1	072120241
42	8	275	96.00	1	072120242
43	9	282	96.00	1	072120243
44	10	288	96.00	1	072120244
45	10.5	295	96.00	1	072120245
46	11	302	96.00	1	072120246
47	12	308	96.00	1	072120247
48	13	315	96.00	1	072120248

CE



S1P SRC ESD



EN ISO 20345 2011



7212G

chaussure basse aérée en croûte de velours. Avec insert anti-abrasion sur l'embout Extrêmement flexible et légère - Poids approximatif pour la taille 42 : 490 g Non indiquée pour des utilisations contraignantes (bâtiment, agriculture, industrie lourde)

- Embout en composite
- Semelle anti-perforation en fibre composite

EU	UK	mm	CHF		
35	2.5	228	96.00	1	072120335
36	3.5	235	96.00	1	072120336
37	4.5	242	96.00	1	072120337
38	5	248	96.00	1	072120338
39	6	255	96.00	1	072120339
40	6.5	262	96.00	1	072120340
41	7	268	96.00	1	072120341
42	8	275	96.00	1	072120342
43	9	282	96.00	1	072120343
44	10	288	96.00	1	072120344
45	10.5	295	96.00	1	072120345
46	11	302	96.00	1	072120346
47	12	308	96.00	1	072120347
48	13	315	96.00	1	072120348

CE



S1P SRC ESD



EN ISO 20345 2011



7212LG

Chaussure basse "femme" en croûte de velours aérée avec inserts en tissu mesh Extrêmement flexible et légère - Poids indicatif mesure 38: 380 g Non indiquée pour des utilisations contraignantes (bâtiment, agriculture, industrie lourde)

- Embout en composite
- Semelle anti-perforation en fibre composite

EU	UK	mm	CHF		
34	2	222	91.50	1	072120134
35	2.5	228	91.50	1	072120135
36	3.5	235	91.50	1	072120136
37	4.5	242	91.50	1	072120137
38	5	248	91.50	1	072120138
39	6	255	91.50	1	072120139
40	6.5	262	91.50	1	072120140
41	7	268	91.50	1	072120141
42	8	275	91.50	1	072120142

CE



S1P SRC



EN ISO 20345 2011



7213G

Chaussure basse en croûte de velours aérée avec inserts en tissu mesh hautement respirant Extrêmement flexible et légère - Poids approximatif pour la taille 42: 490 g Non indiquée pour des utilisations contraignantes (bâtiment, agriculture, industrie lourde)

- Embout en composite
- Semelle anti-perforation en fibre composite

EU	UK	mm	CHF		
35	2,5	228	96.00	1	072130135
36	3,5	235	96.00	1	072130136
37	4,5	242	96.00	1	072130137
38	5	248	96.00	1	072130138
39	6	255	96.00	1	072130139
40	6,5	262	96.00	1	072130140
41	7	268	96.00	1	072130141
42	8	275	96.00	1	072130142
43	9	282	96.00	1	072130143
44	10	288	96.00	1	072130144
45	10,5	295	96.00	1	072130145
46	11	302	96.00	1	072130146
47	12	308	96.00	1	072130147
48	13	315	96.00	1	072130148

CE



S1P SRC ESD



EN ISO 20345 2011



7214FN

Chaussure basse en Nubuck Action hydrofuge avec insert anti-abrasion sur l'embout Extrêmement flexible et légère - poids indicatif pointure 42: 500 g Non indiquée pour des utilisations contraignantes (bâtiment, agriculture, industrie lourde)

- Embout en composite
- Semelle anti-perforation en fibre composite

EU	UK	mm	CHF		
35	2,5	228	104.00	1	072140035
36	3,5	235	104.00	1	072140036
37	4,5	242	104.00	1	072140037
38	5	248	104.00	1	072140038
39	6	255	104.00	1	072140039
40	6,5	262	104.00	1	072140040
41	7	268	104.00	1	072140041
42	8	275	104.00	1	072140042
43	9	282	104.00	1	072140043
44	10	288	104.00	1	072140044
45	10,5	295	104.00	1	072140045
46	11	302	104.00	1	072140046
47	12	308	104.00	1	072140047
48	13	315	104.00	1	072140048

CE



S3 SRC



EN ISO 20345 2011



7214G

Chaussure basse en Nubuck Action hydrofuge avec insert anti-abrasion sur l'embout Extrêmement flexible et légère - Poids approximatif pour la taille 42: 500 g Non indiquée pour des utilisations contraignantes (bâtiment, agriculture, industrie lourde)

- Embout en composite
- Semelle anti-perforation en fibre composite

EU	UK	mm	CHF		
35	2,5	228	104.00	1	072140235
36	3,5	235	104.00	1	072140236
37	4,5	242	104.00	1	072140237
38	5	248	104.00	1	072140238
39	6	255	104.00	1	072140239
40	6,5	262	104.00	1	072140240
41	7	268	104.00	1	072140241
42	8	275	104.00	1	072140242
43	9	282	104.00	1	072140243
44	10	288	104.00	1	072140244
45	10,5	295	104.00	1	072140245
46	11	302	104.00	1	072140246
47	12	308	104.00	1	072140247
48	13	315	104.00	1	072140248

CE



S3 SRC ESD



EN ISO 20345 2011



7214LN

Chaussure basse "femme" en croûte de velours hydrofuge avec insert anti-abrasion sur l'embout Extrêmement flexible et légère - Poids indicatif mesure 38: 380 g Non indiquée pour des utilisations contraignantes (bâtiment, agriculture, industrie lourde)

- Embout en composite
- Semelle anti-perforation en fibre composite

EU	UK	mm	CHF		
34	2	222	96.00	1	072140134
35	2,5	228	96.00	1	072140135
36	3,5	235	96.00	1	072140136
37	4,5	242	96.00	1	072140137
38	5	248	96.00	1	072140138
39	6	255	96.00	1	072140139
40	6,5	262	96.00	1	072140140
41	7	268	96.00	1	072140141
42	8	275	96.00	1	072140142

CE



S3 SRC



EN ISO 20345 2011



7215FN

Mocassin en Nubuck Action hydrofuge avec insert anti-abrasion sur l'embout Extrêmement flexible et légère - poids indicatif pointure 42: 490 g Non indiquée pour des utilisations contraignantes (bâtiment, agriculture, industrie lourde)

- Embout en composite
- Semelle anti-perforation en fibre composite

EN ISO 20345 2011

METAL FREE



CE

S3 SRC

EU	UK	mm	CHF		
35	2,5	228	105.50	1	072150135
36	3,5	235	105.50	1	072150136
37	4,5	242	105.50	1	072150137
38	5	248	105.50	1	072150138
39	6	255	105.50	1	072150139
40	6,5	262	105.50	1	072150140
41	7	268	105.50	1	072150141
42	8	275	105.50	1	072150142
43	9	282	105.50	1	072150143
44	10	288	105.50	1	072150144
45	10,5	295	105.50	1	072150145
46	11	302	105.50	1	072150146
47	12	308	105.50	1	072150147
48	13	315	105.50	1	072150148

7218FN

Chaussure montante en Nubuck Action hydrofuge avec insert anti-abrasion sur l'embout, délaçage rapide Extrêmement flexible et légère - poids indicatif pointure 42 : 510 g Non indiquée pour des utilisations contraignantes (bâtiment, agriculture, industrie lourde)

- Embout en composite
- Semelle anti-perforation en fibre composite

EN ISO 20345 2011

METAL FREE



CE

S3 RS SRC

EU	UK	mm	CHF		
35	2,5	228	108.50	1	072180035
36	3,5	235	108.50	1	072180036
37	4,5	242	108.50	1	072180037
38	5	248	108.50	1	072180038
39	6	255	108.50	1	072180039
40	6,5	262	108.50	1	072180040
41	7	268	108.50	1	072180041
42	8	275	108.50	1	072180042
43	9	282	108.50	1	072180043
44	10	288	108.50	1	072180044
45	10,5	295	108.50	1	072180045
46	11	302	108.50	1	072180046
47	12	308	108.50	1	072180047
48	13	315	108.50	1	072180048

7218G

Chaussure montante en Nubuck Action hydrofuge avec insert anti-abrasion sur l'embout. Délaçage rapide Extrêmement flexible et légère - Poids approximatif pour la taille 42: 550 g Non indiquée pour des utilisations contraignantes (bâtiment, agriculture, industrie lourde)

- Embout en composite
- Semelle anti-perforation en fibre composite

EN ISO 20345 2011

ESD

METAL FREE



CE

S3 RS SRC ESD

EU	UK	mm	CHF		
35	2,5	228	103.50	1	072180135
36	3,5	235	108.50	1	072180136
37	4,5	242	108.50	1	072180137
38	5	248	108.50	1	072180138
39	6	255	108.50	1	072180139
40	6,5	262	108.50	1	072180140
41	7	268	108.50	1	072180141
42	8	275	108.50	1	072180142
43	9	282	108.50	1	072180143
44	10	288	108.50	1	072180144
45	10,5	295	108.50	1	072180145
46	11	302	108.50	1	072180146
47	12	308	108.50	1	072180147
48	13	315	108.50	1	072180148

Beta

BASIC PLUS



7200BKK

Chaussure basse type Derby en cuir pleine fleur pigmenté hydrofuge

- Embout en composite
- Semelle anti-perforation en fibre composite

EU	UK	mm	CHF		
35	2,5	228	99.50	1	072000235
36	3,5	235	99.50	1	072000236
37	4,5	242	99.50	1	072000237
38	5	248	99.50	1	072000238
39	6	255	99.50	1	072000239
40	6,5	262	99.50	1	072000240
41	7	268	99.50	1	072000241
42	8	275	99.50	1	072000242
43	9	282	99.50	1	072000243
44	10	288	99.50	1	072000244
45	10,5	295	99.50	1	072000245
46	11	302	99.50	1	072000246
47	12	308	99.50	1	072000247
48	13	315	99.50	1	072000248



CE

S3 SRC

EN ISO 20345 2011

METAL FREE



7201BKK

Chaussure montante type Brodequin en cuir pleine fleur pigmenté hydrofuge

- Embout en composite
- Semelle anti-perforation en fibre composite

EU	UK	mm	CHF		
35	2,5	228	104.50	1	072010435
36	3,5	235	104.50	1	072010436
37	4,5	242	104.50	1	072010437
38	5	248	104.50	1	072010438
39	6	255	104.50	1	072010439
40	6,5	262	104.50	1	072010440
41	7	268	104.50	1	072010441
42	8	275	104.50	1	072010442
43	9	282	104.50	1	072010443
44	10	288	104.50	1	072010444
45	10,5	295	104.50	1	072010445
46	11	302	104.50	1	072010446
47	12	308	104.50	1	072010447
48	13	315	104.50	1	072010448



CE

S3 SRC

EN ISO 20345 2011

METAL FREE



7210BKK

Chaussure basse type tennis aérée, en croûte de velours souple

- Embout en composite
- Semelle anti-perforation en fibre composite

EU	UK	mm	CHF		
35	2,5	228	98.00	1	072100335
36	3,5	235	98.00	1	072100336
37	4,5	242	98.00	1	072100337
38	5	248	98.00	1	072100338
39	6	255	98.00	1	072100339
40	6,5	262	98.00	1	072100340
41	7	268	98.00	1	072100341
42	8	275	98.00	1	072100342
43	9	282	98.00	1	072100343
44	10	288	98.00	1	072100344
45	10,5	295	98.00	1	072100345
46	11	302	98.00	1	072100346
47	12	308	98.00	1	072100347
48	13	315	98.00	1	072100348



CE

S1P SRC

EN ISO 20345 2011

METAL FREE



7216BKK

Chaussure basse type sandale en croûte de velours souple, avec fermeture type "scratch"

- Embout en composite
- Semelle anti-perforation en fibre composite

EU	UK	mm	CHF		
35	2,5	228	102.00	1	072160335
36	3,5	235	102.00	1	072160336
37	4,5	242	102.00	1	072160337
38	5	248	102.00	1	072160338
39	6	255	102.00	1	072160339
40	6,5	262	102.00	1	072160340
41	7	268	102.00	1	072160341
42	8	275	102.00	1	072160342
43	9	282	102.00	1	072160343
44	10	288	102.00	1	072160344
45	10,5	295	102.00	1	072160345
46	11	302	102.00	1	072160346
47	12	308	102.00	1	072160347
48	13	315	102.00	1	072160348

CE



S1P SRC

METAL
FREE

EN ISO
20345
2011



7310CRK

Chaussure basse type "soudeur" à lacets, en cuir pigmenté imprimé hydrofuge, délaçage rapide et protection frontale avec languette d'ouverture rapide type "scratch" et coutures antinflamme Semelle en caoutchouc haute résistance et insert anti-abrasion sur l'embout

- Embout en composite
- Semelle anti-perforation en fibre composite

EU	UK	mm	CHF		
35	2,5	227	117.50	1	073100335
36	3,5	234	117.50	1	073100336
37	4,5	241	117.50	1	073100337
38	5	247	117.50	1	073100338
39	6	254	117.50	1	073100339
40	6,5	261	117.50	1	073100340
41	7	267	117.50	1	073100341
42	8	274	117.50	1	073100342
43	9	281	117.50	1	073100343
44	10	287	117.50	1	073100344
45	10,5	294	117.50	1	073100345
46	11	301	117.50	1	073100346
47	12	307	117.50	1	073100347
48	13	314	117.50	1	073100348

CE



S3 RS HRO SRC

EN ISO
20345
2011



TREKKING



7235BK

Chaussure basse en Nubuck Action hydrofuge avec couvre-embout renforcé en polyuréthane

- Embout en acier
- Semelle anti-perforation en fibre composite

EU	UK	mm	CHF		
35	2,5	228	94.00	1	072350335
36	3,5	235	94.00	1	072350336
37	4,5	242	94.00	1	072350337
38	5	248	94.00	1	072350338
39	6	255	94.00	1	072350339
40	6,5	262	94.00	1	072350340
41	7	268	94.00	1	072350341
42	8	275	94.00	1	072350342
43	9	282	94.00	1	072350343
44	10	288	94.00	1	072350344
45	10,5	295	94.00	1	072350345
46	11	302	94.00	1	072350346
47	12	308	94.00	1	072350347
48	13	315	94.00	1	072350348

CE



S3 SRC

EN ISO
20345
2011



7236BK

Chaussure montante en Nubuck Action hydrofuge à délaçage rapide, avec couvre-embout renforcé en polyuréthane

- Embout en acier
- Semelle anti-perforation en fibre composite

EU	UK	mm	CHF		
35	2,5	228	99.00	1	072360335
36	3,5	235	99.00	1	072360336
37	4,5	242	99.00	1	072360337
38	5	248	99.00	1	072360338
39	6	255	99.00	1	072360339
40	6,5	262	99.00	1	072360340
41	7	268	99.00	1	072360341
42	8	275	99.00	1	072360342
43	9	282	99.00	1	072360343
44	10	288	99.00	1	072360344
45	10,5	295	99.00	1	072360345
46	11	302	99.00	1	072360346
47	12	308	99.00	1	072360347
48	13	315	99.00	1	072360348



CE

S3 RS SRC

EN ISO 20345 2011



7238WR

Chaussure montante en cuir velours avec inserts en nylon, semelle en caoutchouc haute résistance, délaçage rapide soumise à test dans un cuve avec 3 cm d'eau, après 1000 longueurs, la zone totale mouillée à l'intérieur de la chaussure ne doit pas dép

- Embout en composite
- Semelle anti-perforation en fibre composite

EU	UK	mm	CHF		
35	2,5	228	132.50	1	072380235
36	3,5	235	132.50	1	072380236
37	4,5	242	132.50	1	072380237
38	5	248	132.50	1	072380238
39	6	255	132.50	1	072380239
40	6,5	262	132.50	1	072380240
41	7	268	132.50	1	072380241
42	8	275	132.50	1	072380242
43	9	282	132.50	1	072380243
44	10	288	132.50	1	072380244
45	10,5	295	132.50	1	072380245
46	11	302	132.50	1	072380246
47	12	308	132.50	1	072380247
48	13	315	132.50	1	072380248



CE

S3 RS WR HRO SRC

EN ISO 20345 2011



7239B

Bottine en nubuck, hydrofuge, avec inserts en mesh et renfort en polyuréthane pour les orteils - S3 SRC

- Embout en acier
- Semelle antiperforation en fibre composite

EU	UK	mm	CHF		
39	6	258	143.00	1	072390339
40	6,5	265	143.00	1	072390340
41	7	271	143.00	1	072390341
42	8	278	143.00	1	072390342
43	9	285	143.00	1	072390343
44	10	291	143.00	1	072390344
45	10,5	298	143.00	1	072390345
46	11	305	143.00	1	072390346
47	12	311	143.00	1	072390347
48	13	318	143.00	1	072390348



CE

S3 SRC

EN ISO 20345 2011



7248GK

Chaussure basse en croûte de velours avec inserts en nylon et couvre-embout renforcé en polyuréthane

- Embout en acier
- Semelle anti-perforation en fibre composite

EU	UK	mm	CHF		
35	2,5	231	78.00	1	072480235
36	3,5	238	78.00	1	072480236
37	4,5	245	78.00	1	072480237
38	5	251	78.00	1	072480238
39	6	258	78.00	1	072480239
40	6,5	265	78.00	1	072480240
41	7	271	78.00	1	072480241
42	8	278	78.00	1	072480242
43	9	285	78.00	1	072480243
44	10	291	78.00	1	072480244
45	10,5	298	78.00	1	072480245
46	11	305	78.00	1	072480246
47	12	311	78.00	1	072480247
48	13	318	78.00	1	072480248



CE

S1P SRC

EN ISO 20345 2011



7249GK

Chaussure montante en croûte de velours à délaçage rapide, avec inserts en nylon et couvre-embout renforcé en polyuréthane

- Embout en acier
- Semelle anti-perforation en fibre composite

EU	UK	mm	CHF		
35	2,5	231	83.00	1	072490235
36	3,5	238	83.00	1	072490236
37	4,5	245	83.00	1	072490237
38	5	251	83.00	1	072490238
39	6	258	83.00	1	072490239
40	6,5	265	83.00	1	072490240
41	7	271	83.00	1	072490241
42	8	278	83.00	1	072490242
43	9	285	83.00	1	072490243
44	10	291	83.00	1	072490244
45	10,5	298	83.00	1	072490245
46	11	305	83.00	1	072490246
47	12	311	83.00	1	072490247
48	13	318	83.00	1	072490248

CE



S1P RS SRC

EN ISO
20345
2011



ACTIVE



7314AF

Chaussure basse en cuir velours avec inserts en nylon mesh et carbone

- Embout en composite
- Semelle antiperforation en fibre composite

EU	UK	mm	CHF		
35	2,5	228	132.00	1	073140235
36	3,5	235	132.00	1	073140236
37	4,5	242	132.00	1	073140237
38	5	248	132.00	1	073140238
39	6	255	132.00	1	073140239
40	6,5	262	132.00	1	073140240
41	7	268	132.00	1	073140241
42	8	275	132.00	1	073140242
43	9	282	132.00	1	073140243
44	10	288	132.00	1	073140244
45	10,5	295	132.00	1	073140245
46	11	302	132.00	1	073140246
47	12	308	132.00	1	073140247
48	13	315	132.00	1	073140248

CE



S1P SRC

EN ISO
20345
2011

METAL
FREE



7315AN

Chaussure basse en cuir velours et microfibre hydrofuges avec inserts en carbone

- Embout en composite
- Semelle antiperforation en fibre composite

EU	UK	mm	CHF		
35	2,5	228	152.00	1	073150535
36	3,5	235	152.00	1	073150536
37	4,5	242	152.00	1	073150537
38	5	248	152.00	1	073150538
39	6	255	152.00	1	073150539
40	6,5	262	152.00	1	073150540
41	7	268	152.00	1	073150541
42	8	275	152.00	1	073150542
43	9	282	152.00	1	073150543
44	10	288	152.00	1	073150544
45	10,5	295	152.00	1	073150545
46	11	302	152.00	1	073150546
47	12	308	152.00	1	073150547
48	13	315	152.00	1	073150548

CE



S3 SRC

EN ISO
20345
2011

METAL
FREE



7316NB

Chaussure basse en tissu mesh à haute respirabilité et croûte de velours avec maintien de la stabilité du talon

- Embout en composite
- Semelle anti-perforation en fibre composite

EU	UK	mm	CHF		
35	2,5	228	114.50	1	073160735
36	3,5	235	114.50	1	073160736
37	4,5	242	114.50	1	073160737
38	5	248	114.50	1	073160738
39	6	255	114.50	1	073160739
40	6,5	262	114.50	1	073160740
41	7	268	114.50	1	073160741
42	8	275	114.50	1	073160742
43	9	282	114.50	1	073160743
44	10	288	114.50	1	073160744
45	10,5	295	114.50	1	073160745
46	11	302	114.50	1	073160746
47	12	308	114.50	1	073160747
48	13	315	114.50	1	073160748

CE



S1P SRC ESD



EN ISO 20345 2011



7316NG

Chaussure basse en tissu mesh à haute respirabilité et croûte de velours avec maintien de la stabilité du talon

- Embout en composite
- Semelle anti-perforation en fibre composite

EU	UK	mm	CHF		
35	2,5	228	114.50	1	073160635
36	3,5	235	114.50	1	073160636
37	4,5	242	114.50	1	073160637
38	5	248	114.50	1	073160638
39	6	255	114.50	1	073160639
40	6,5	262	114.50	1	073160640
41	7	268	114.50	1	073160641
42	8	275	114.50	1	073160642
43	9	282	114.50	1	073160643
44	10	288	114.50	1	073160644
45	10,5	295	114.50	1	073160645
46	11	302	114.50	1	073160646
47	12	308	114.50	1	073160647
48	13	315	114.50	1	073160648

CE



S1P SRC ESD



EN ISO 20345 2011



7317NA

Chaussure basse aérée en croûte de velours avec renfort en microfibre dans la zone du talon

- Embout en composite
- Semelle anti-perforation en fibre composite

EU	UK	mm	CHF		
35	2,5	228	98.00	1	073170135
36	3,5	235	98.00	1	073170136
37	4,5	242	98.00	1	073170137
38	5	248	98.00	1	073170138
39	6	255	98.00	1	073170139
40	6,5	262	98.00	1	073170140
41	7	268	98.00	1	073170141
42	8	275	98.00	1	073170142
43	9	282	98.00	1	073170143
44	10	288	98.00	1	073170144
45	10,5	295	98.00	1	073170145
46	11	302	98.00	1	073170146
47	12	308	98.00	1	073170147
48	13	315	98.00	1	073170148

CE



S1P SRC



EN ISO 20345 2011



7318AN

Chaussure montante en croûte de velours et microfibre, hydrofuge, avec inserts en carbone

- Embout en composite
- Semelle anti-perforation en fibre composite

EU	UK	mm	CHF		
35	2,5	228	158.00	1	073180535
36	3,5	235	158.00	1	073180536
37	4,5	242	158.00	1	073180537
38	5	248	158.00	1	073180538
39	6	255	158.00	1	073180539
40	6,5	262	158.00	1	073180540
41	7	268	158.00	1	073180541
42	8	275	158.00	1	073180542
43	9	282	158.00	1	073180543
44	10	288	158.00	1	073180544
45	10,5	295	158.00	1	073180545
46	11	302	158.00	1	073180546
47	12	308	158.00	1	073180547
48	13	315	158.00	1	073180548

CE



S3 SRC



EN ISO 20345 2011



7320NA

Chaussure basse en Nubuck hydrofuge avec renfort anti-abrasion dans la zone de l'embout

- Embout en composite
- Semelle anti-perforation en fibre composite

EU	UK	mm	CHF		
35	2,5	228	103.50	1	073200435
36	3,5	235	103.50	1	073200436
37	4,5	242	103.50	1	073200437
38	5	248	103.50	1	073200438
39	6	255	103.50	1	073200439
40	6,5	262	103.50	1	073200440
41	7	268	103.50	1	073200441
42	8	275	103.50	1	073200442
43	9	282	103.50	1	073200443
44	10	288	103.50	1	073200444
45	10,5	295	103.50	1	073200445
46	11	302	103.50	1	073200446
47	12	308	103.50	1	073200447
48	13	315	103.50	1	073200448

CE



S3 SRC



EN ISO 20345 2011



7321NA

Chaussure haute en Nubuck hydrofuge, délaçage rapide, avec renfort anti-abrasion dans la zone de l'embout

- Embout en composite
- Semelle anti-perforation en fibre composite

EU	UK	mm	CHF		
35	2,5	228	106.50	1	073210435
36	3,5	235	106.50	1	073210436
37	4,5	242	106.50	1	073210437
38	5	248	106.50	1	073210438
39	6	255	106.50	1	073210439
40	6,5	262	106.50	1	073210440
41	7	268	106.50	1	073210441
42	8	275	106.50	1	073210442
43	9	282	106.50	1	073210443
44	10	288	106.50	1	073210444
45	10,5	295	106.50	1	073210445
46	11	302	106.50	1	073210446
47	12	308	106.50	1	073210447
48	13	315	106.50	1	073210448

CE



S3 RS SRC



EN ISO 20345 2011



7322SA

Chaussure Basse en tissu, très résistante à l'abrasion, avec support de stabilité du talon - S3 SRC

- Embout composite
- Semelle antiperforation en fibre composite

EU	UK	mm	CHF		
35	2,5	228	112.00	1	073220435
36	3,5	235	112.00	1	073220436
37	4,5	242	112.00	1	073220437
38	5	248	112.00	1	073220438
39	6	255	112.00	1	073220439
40	6,5	262	112.00	1	073220440
41	7	268	112.00	1	073220441
42	8	275	112.00	1	073220442
43	9	282	112.00	1	073220443
44	10	288	112.00	1	073220444
45	10,5	295	112.00	1	073220445
46	11	302	112.00	1	073220446
47	12	308	112.00	1	073220447
48	13	315	112.00	1	073220448

CE



S3 SRC



EN ISO 20345 2011



7323SA

Chaussure Montante en tissu, très résistante à l'abrasion, avec système délaçage rapide et support de stabilité du talon - S3 SRC

- Embout composite
- Semelle antiperforation en fibre composite

EU	UK	mm	CHF		
35	2,5	228	115.00	1	073230435
36	3,5	235	115.00	1	073230436
37	4,5	242	115.00	1	073230437
38	5	248	115.00	1	073230438
39	6	255	115.00	1	073230439
40	6,5	262	115.00	1	073230440
41	7	268	115.00	1	073230441
42	8	275	115.00	1	073230442
43	9	282	115.00	1	073230443
44	10	288	115.00	1	073230444
45	10,5	295	115.00	1	073230445
46	11	302	115.00	1	073230446
47	12	308	115.00	1	073230447
48	13	315	115.00	1	073230448

CE



S3 RS SRC



EN ISO 20345 2011



O-GRAVITY



7352A

Chaussure basse en tissu mesh à haute respirabilité avec inserts en TPU Support de stabilité talon, col "slip on" élastifié pour faciliter le maintien et semelle en EVA avec semelle extérieure en caoutchouc nitrile à haute résistance

- Embout en composite
- Semelle anti-perforation en fibre composite
- LÉGÈRETÉ EXCEPTIONNELLE : poids indicatif taille 42 : 450 grammes

EN ISO
20345
2011

EU	UK	mm	CHF		
38	5	254	171.50	1	073520038
39	6	261	171.50	1	073520039
40	6,5	268	171.50	1	073520040
41	7	274	171.50	1	073520041
42	8	281	171.50	1	073520042
43	9	288	171.50	1	073520043
44	10	294	171.50	1	073520044
45	10,5	301	171.50	1	073520045
46	11	308	171.50	1	073520046
47	12	314	171.50	1	073520047
48	13	321	171.50	1	073520048



METAL
FREE



CE

S1P HRO SRC

7352B

Chaussure basse en tissu mesh à haute respirabilité avec inserts en TPU Support de stabilité talon, col "slip on" élastifié pour faciliter le maintien et semelle en EVA avec semelle extérieure en caoutchouc nitrile à haute résistance

- Embout en composite
- Semelle anti-perforation en fibre composite
- LÉGÈRETÉ EXCEPTIONNELLE : poids indicatif taille 42 : 450 grammes

EN ISO
20345
2011

EU	UK	mm	CHF		
38	5	254	171.50	1	073520138
39	6	261	171.50	1	073520139
40	6,5	268	171.50	1	073520140
41	7	274	171.50	1	073520141
42	8	281	171.50	1	073520142
43	9	288	171.50	1	073520143
44	10	294	171.50	1	073520144
45	10,5	301	171.50	1	073520145
46	11	308	171.50	1	073520146
47	12	314	171.50	1	073520147
48	13	321	171.50	1	073520148



METAL
FREE



CE

S1P HRO SRC

7352G

chaussure en tissu maillé, très respirante, avec inserts en TPU Support de stabilité du talon, laçage traditionnel, coupe large. Semelle extérieure en EVA avec bande de roulement en caoutchouc nitrile durable

- embout composite
- Semelle intérieure résistante à la pénétration en fibre composite
- EXTREMEMENT LÉGER: poids approximatif pour la taille 42: 450 grammes

EN ISO
20345
2011

EU	UK	mm	CHF		
38	5	254	177.50	1	073520338
39	6	261	177.50	1	073520339
40	6,5	268	177.50	1	073520340
41	7	274	177.50	1	073520341
42	8	281	177.50	1	073520342
43	9	288	177.50	1	073520343
44	10	294	177.50	1	073520344
45	10,5	301	177.50	1	073520345
46	11	308	177.50	1	073520346
47	12	314	177.50	1	073520347
48	13	321	177.50	1	073520348



METAL
FREE



CE

S1P HRO SRC ESD

7352LG

Chaussure Basse en tissu mesh pour femme, hautement respirante, avec inserts en TPU
Tige en mesh réfléchissant haute visibilité
Maintien de la stabilité du talon, col à enfiler extensible et semelle extérieure en EVA avec bande de roulement en caoutchouc nitrile durable - S1P HRO SRC

- Embout en fibre de verre
- Semelle antiperforation en fibre composite
- ULTRA LÉGER: poids approximatif pour la taille 38: 390 grammes

EN ISO 20345 2011

EU	UK	mm	CHF		
34	2	228	177.00	1	073520234
35	2,5	234	177.00	1	073520235
36	3,5	241	177.00	1	073520236
37	4,5	248	177.00	1	073520237
38	5	254	177.00	1	073520238
39	6	261	177.00	1	073520239
40	6,5	268	177.00	1	073520240
41	7	274	177.00	1	073520241
42	8	281	177.00	1	073520242

CE



S1P HRO SRC

METAL FREE



7353Y

Chaussure basse en tissu mesh à haute respirabilité avec inserts en TPU Tige dotée de mailles spéciales réfléchissantes à haute visibilité Support de stabilité talon, col "slip on" élastifié pour faciliter le maintien et semelle en EVA avec semelle extérieure en caoutchouc nitrile à haute résistance

- Embout en fibre de carbone
- Semelle anti-perforation en fibre composite
- LÉGÈRETÉ EXCEPTIONNELLE : poids indicatif taille 42 : 420 grammes

EN ISO 20345 2011

EU	UK	mm	CHF		
38	5	254	220.50	1	073530038
39	6	261	220.50	1	073530039
40	6,5	268	220.50	1	073530040
41	7	274	220.50	1	073530041
42	8	281	220.50	1	073530042
43	9	288	220.50	1	073530043
44	10	294	220.50	1	073530044
45	10,5	301	220.50	1	073530045
46	11	308	220.50	1	073530046
47	12	314	220.50	1	073530047
48	13	321	220.50	1	073530048

CE



S1P HRO SRC



7354N

Chaussure basse en tissu mesh avec inserts en TPU Support de stabilité talon, col "slip on" élastifié pour faciliter le maintien et semelle en EVA avec semelle extérieure en caoutchouc nitrile à haute résistance

- Embout en composite
- Semelle anti-perforation en fibre composite
- LÉGÈRETÉ EXCEPTIONNELLE : poids indicatif taille 42 : 460 grammes

EN ISO 20345 2011

EU	UK	mm	CHF		
38	5	254	177.00	1	073540038
39	6	261	177.00	1	073540039
40	6,5	268	177.00	1	073540040
41	7	274	177.00	1	073540041
42	8	281	177.00	1	073540042
43	9	288	177.00	1	073540043
44	10	294	177.00	1	073540044
45	10,5	301	177.00	1	073540045
46	11	308	177.00	1	073540046
47	12	314	177.00	1	073540047
48	13	321	177.00	1	073540048

CE



S3 HRO SRC



METAL FREE



7355V

Chaussure montante en tissu mesh avec inserts en TPU Support de stabilité talon, col "slip on" élastifié pour faciliter le maintien et semelle en EVA avec semelle extérieure en caoutchouc nitrile à haute résistance

- Embout en composite
- Semelle anti-perforation en fibre composite
- LÉGÈRETÉ EXCEPTIONNELLE : poids indicatif taille 42 : 465 grammes

EN ISO 20345 2011

EU	UK	mm	CHF		
38	5	254	189.00	1	073550038
39	6	261	189.00	1	073550039
40	6,5	268	189.00	1	073550040
41	7	274	189.00	1	073550041
42	8	281	189.00	1	073550042
43	9	288	189.00	1	073550043
44	10	294	189.00	1	073550044
45	10,5	301	189.00	1	073550045
46	11	308	189.00	1	073550046
47	12	314	189.00	1	073550047
48	13	321	189.00	1	073550048

CE



S3 HRO SRC



METAL FREE



7356G

Chaussure basse en microfibre hydrofuge avec inserts en TPU
Support de stabilité talon, col "slip on" élastifié pour faciliter le maintien et semelle en EVA avec semelle extérieure en caoutchouc nitrile à haute résistance

- Embout en composite
- Semelle anti-perforation en fibre composite
- LÉGÈRETÉ EXCEPTIONNELLE : poids indicatif taille 42 : 460 grammes

EN ISO 20345 2011

EU	UK	mm	CHF		
38	5	254	182.50	1	073560038
39	6	261	182.50	1	073560039
40	6,5	268	182.50	1	073560040
41	7	274	182.50	1	073560041
42	8	281	182.50	1	073560042
43	9	288	182.50	1	073560043
44	10	294	182.50	1	073560044
45	10,5	301	182.50	1	073560045
46	11	308	182.50	1	073560046
47	12	314	182.50	1	073560047
48	13	321	182.50	1	073560048



CE

S3 HRO SRC

7356V

Chaussure Basse en microfibre, hydrofuge, avec inserts en TPU
Maintien de la stabilité du talon, col à enfiler extensible et semelle extérieure en EVA avec bande de roulement en caoutchouc nitrile durable - S3 HRO SRC

- Embout composite
- Semelle antiperforation en fibre composite
- ULTRA LÉGER: poids approximatif pour la taille 42: 460 grammes

EN ISO 20345 2011

EU	UK	mm	CHF		
38	5	254	182.50	1	073560138
39	6	261	182.50	1	073560139
40	6,5	268	182.50	1	073560140
41	7	274	182.50	1	073560141
42	8	281	182.50	1	073560142
43	9	288	182.50	1	073560143
44	10	294	182.50	1	073560144
45	10,5	301	182.50	1	073560145
46	11	308	182.50	1	073560146
47	12	314	182.50	1	073560147
48	13	321	182.50	1	073560148



CE

S3 HRO SRC

7356LN

chaussure en microfibre pour femme, déperlante, avec inserts en TPU
Maintien de la stabilité du talon, col à enfiler extensible et semelle extérieure en EVA avec bande de roulement en caoutchouc nitrile durable

- Embout en fibre de verre
- Semelle intérieure résistante à la pénétration de fibre composite
- REMARQUABLEMENT LÉGER: poids approximatif pour la taille 38: 400 grammes

EN ISO 20345 2011

EU	UK	mm	CHF		
34	2	228	181.50	1	073560234
35	2,5	234	181.50	1	073560235
36	3,5	241	181.50	1	073560236
37	4,5	248	181.50	1	073560237
38	5	254	181.50	1	073560238
39	6	261	181.50	1	073560239
40	6,5	268	181.50	1	073560240
41	7	274	181.50	1	073560241
42	8	281	181.50	1	073560242



lady



CE

S3 HRO SRC

7357G

Chaussure montante en microfibre hydrofuge avec inserts en TPU
Support de stabilité talon, col élastifié pour faciliter le maintien et semelle en EVA con semelle extérieure en caoutchouc nitrile à haute résistance

- Embout en composite
- Semelle anti-perforation en fibre composite
- LÉGÈRETÉ EXCEPTIONNELLE : poids indicatif taille 42 : 480 grammes

EN ISO 20345 2011

EU	UK	mm	CHF		
38	5	254	202.00	1	073570038
39	6	261	202.00	1	073570039
40	6,5	268	202.00	1	073570040
41	7	274	202.00	1	073570041
42	8	281	202.00	1	073570042
43	9	288	202.00	1	073570043
44	10	294	202.00	1	073570044
45	10,5	301	202.00	1	073570045
46	11	308	202.00	1	073570046
47	12	314	202.00	1	073570047
48	13	321	202.00	1	073570048



CE

S3 HRO SRC

7357V

Chaussure Montante en microfibre, hydrofuge, avec inserts en TPU

Maintien de la stabilité du talon, glissement extensible sur le col et semelle extérieure en EVA avec bande de roulement en caoutchouc nitrile durable - S3 HRO SRC

- Embout composite
- Semelle antiperforation en fibre composite
- ULTRA LÉGER: poids approximatif pour la taille 42: 480 grammes

EN ISO 20345 2011

EU	UK	mm	CHF	St	Art
38	5	254	202.00	1	073570138
39	6	261	202.00	1	073570139
40	6,5	268	202.00	1	073570140
41	7	274	202.00	1	073570141
42	8	281	202.00	1	073570142
43	9	288	202.00	1	073570143
44	10	294	202.00	1	073570144
45	10,5	301	202.00	1	073570145
46	11	308	202.00	1	073570146
47	12	314	202.00	1	073570147
48	13	321	202.00	1	073570148

CE



S3 HRO SRC



7362B

Chaussure basse "occupational" en tissu mesh à haute respirabilité avec inserts en TPU

Support de stabilité talon, col "slip on" élastifié pour faciliter le maintien

et semelle en EVA avec semelle extérieure en caoutchouc nitrile haute résistance

- Sans embout
- Sans semelle anti-perforation
- LÉGÈRETÉ EXCEPTIONNELLE : poids indicatif taille 42: 330 grammes

EN ISO 20347 2012

EU	UK	mm	CHF	St	Art
39	6	261	155.50	1	073620039
40	6,5	268	155.50	1	073620040
41	7	274	155.50	1	073620041
42	8	281	155.50	1	073620042
43	9	288	155.50	1	073620043
44	10	294	155.50	1	073620044
45	10,5	301	155.50	1	073620045
46	11	308	155.50	1	073620046
47	12	314	155.50	1	073620047
48	13	321	155.50	1	073620048

CE



01 FO HRO SRC



7363N

Chaussure basse "occupational" en tissu mesh hydrofuge avec inserts en TPU

Support de stabilité talon, col "slip on" élastifié pour faciliter le maintien et semelle en EVA avec semelle extérieure en caoutchouc nitrile haute résistance

- Sans embout
- Sans semelle anti-perforation
- LÉGÈRETÉ EXCEPTIONNELLE : poids indicatif taille 42 : 330 grammes

EN ISO 20347 2012

EU	UK	mm	CHF	St	Art
39	6	261	162.00	1	073630039
40	6,5	268	162.00	1	073630040
41	7	274	162.00	1	073630041
42	8	281	162.00	1	073630042
43	9	288	162.00	1	073630043
44	10	294	162.00	1	073630044
45	10,5	301	162.00	1	073630045
46	11	308	162.00	1	073630046
47	12	314	162.00	1	073630047
48	13	321	162.00	1	073630048

CE



02 FO HRO SRC



Beta

7372B

Chaussure basse en tissu sans couture et à haute respirabilité. Maintien de la stabilité du talon, laçage traditionnel. Semelle extérieure en EVA avec bande de roulement en caoutchouc nitrile durable.

- Embout en composite
- Semelle anti-perforation en fibre composite
- EXTRÊMEMENT LÉGÈRE : poids approximatif pour la taille 42: 450 grammes

EN ISO 20345 2011

EU	UK	mm	CHF		
38	5	254	181.50	1	073720038
39	6	261	181.50	1	073720039
40	6,5	268	181.50	1	073720040
41	7	274	181.50	1	073720041
42	8	281	181.50	1	073720042
43	9	288	181.50	1	073720043
44	10	294	181.50	1	073720044
45	10,5	301	181.50	1	073720045
46	11	308	181.50	1	073720046
47	12	314	181.50	1	073720047
48	13	321	181.50	1	073720048



CE

S1P HRO SRC



7376A

Chaussure basse type sandale en microfibre aérée et tissu mesh à haute respirabilité. Maintien de la stabilité du talon, laçage traditionnel avec lacets extensibles. Semelle extérieure en EVA avec bande de roulement en caoutchouc nitrile durable.

- Embout en composite
- Semelle anti-perforation en fibre composite
- EXTRÊMEMENT LÉGÈRE : poids approximatif pour la taille 42: 490 grammes

EN ISO 20345 2011

EU	UK	mm	CHF		
38	5	254	184.00	1	073760038
39	6	261	184.00	1	073760039
40	6,5	268	184.00	1	073760040
41	7	274	184.00	1	073760041
42	8	281	184.00	1	073760042
43	9	288	184.00	1	073760043
44	10	294	184.00	1	073760044
45	10,5	301	184.00	1	073760045
46	11	308	184.00	1	073760046
47	12	314	184.00	1	073760047
48	13	321	184.00	1	073760048



CE

S1P HRO SRC



7381N

Chaussure basse imperméable en tissu hautement résistant à l'abrasion avec empiècements en TPU. Support de stabilité talon, laçage traditionnel, chausse large. Semelle extérieure en EVA avec bande de roulement en caoutchouc nitrile durable.

- Embout en composite
- Semelle anti-perforation en fibre composite
- Membrane imperméabilisante Beta TECH, avec système "bootie"
- LÉGÈRE : poids approximatif pour la taille 42 : 500 grammes

EN ISO 20345 2011

EU	UK	mm	CHF		
38	5	254	210.50	1	073810038
39	6	261	210.50	1	073810039
40	6,5	268	210.50	1	073810040
41	7	274	210.50	1	073810041
42	8	281	210.50	1	073810042
43	9	288	210.50	1	073810043
44	10	294	210.50	1	073810044
45	10,5	301	210.50	1	073810045
46	11	308	210.50	1	073810046
47	12	314	210.50	1	073810047
48	13	321	210.50	1	073810048



CE

S3 SRC HRO WR



7382N

Chaussure montante imperméable en tissu hautement résistant à l'abrasion avec empiècements en TPU. Support de stabilité talon, laçage traditionnel et chausse large. Semelle extérieure en EVA avec bande de roulement en caoutchouc nitrile durable.

- Embout en composite
- Semelle anti-perforation en fibre composite
- Membrane imperméabilisante Beta TECH, avec système "bootie"
- LÉGÈRE : poids approximatif pour la taille 42 : 550 grammes

EN ISO 20345 2011

EU	UK	mm	CHF		
38	5	254	236.00	1	073820038
39	6	261	236.00	1	073820039
40	6,5	268	236.00	1	073820040
41	7	274	236.00	1	073820041
42	8	281	236.00	1	073820042
43	9	288	236.00	1	073820043
44	10	294	236.00	1	073820044
45	10,5	301	236.00	1	073820045
46	11	308	236.00	1	073820046
47	12	314	236.00	1	073820047
48	13	321	236.00	1	073820048



CE

S3 SRC HRO WR



SNEAKERS PRO



7340B

Chaussure basse en tissu mesh à ventilation élevée avec inserts en PU Haute Fréquence et couvre-embout de protection en croûte de velours.

Extrêmement légère - poids indicatif pointure 42 : 470 g

- Embout en aluminium
- Semelle anti-perforation en fibre composite
- Le système de fermeture FixLock facilite la chaussure et la déchaussure (lacets traditionnels inclus)

**EN ISO
20345
2011**



EU	UK	mm	CHF		
36	3,5	238	216.00	1	073400236
37	4,5	245	216.00	1	073400237
38	5	251	216.00	1	073400238
39	6	258	216.00	1	073400239
40	6,5	265	216.00	1	073400240
41	7	271	216.00	1	073400241
42	8	278	216.00	1	073400242
43	9	285	216.00	1	073400243
44	10	291	216.00	1	073400244
45	10,5	298	216.00	1	073400245
46	11	305	216.00	1	073400246
47	12	311	216.00	1	073400247



CE

S1P SRC

7341N

Chaussure basse en micro-croûte de velours hydrofuge avec inserts PU Haute Fréquence et couvre-embout de protection en croûte de velours.

Extrêmement légère - poids indicatif pointure 42 : 470 g

- Embout en aluminium
- Semelle anti-perforation en fibre composite
- Le système de fermeture FixLock facilite la chaussure et la déchaussure (lacets traditionnels inclus)

**EN ISO
20345
2011**



EU	UK	mm	CHF		
36	3,5	238	226.00	1	073410236
37	4,5	245	226.00	1	073410237
38	5	251	226.00	1	073410238
39	6	258	226.00	1	073410239
40	6,5	265	226.00	1	073410240
41	7	271	226.00	1	073410241
42	8	278	226.00	1	073410242
43	9	285	226.00	1	073410243
44	10	291	226.00	1	073410244
45	10,5	298	226.00	1	073410245
46	11	305	226.00	1	073410246
47	12	311	226.00	1	073410247



CE

S3 SRC

7349RP

Chaussure basse en cuir croûte Nubuck hydrofuge avec semelle en caoutchouc et anneau en PU souple

- Embout en composite
- Semelle anti-perforation en fibre composite

**EN ISO
20345
2011**

METAL
FREE



EU	UK	mm	CHF		
38	5	254	229.00	1	073490138
39	6	260	229.00	1	073490139
40	6,5	267	229.00	1	073490140
41	7	274	229.00	1	073490141
42	8	280	229.00	1	073490142
43	9	287	229.00	1	073490143
44	10	294	229.00	1	073490144
45	10,5	300	229.00	1	073490145
46	11	307	229.00	1	073490146
47	12	314	229.00	1	073490147



CE

S3 HRO SRC

7350RP

Chaussure montante en cuir croûte Nubuck hydrofuge avec semelle en caoutchouc et anneau en PU souple

- Embout en composite
- Semelle anti-perforation en fibre composite

EN ISO 20345 2011

METAL FREE



EU	UK	mm	CHF		
38	5	254	234.00	1	073500138
39	6	260	234.00	1	073500139
40	6,5	267	234.00	1	073500140
41	7	274	234.00	1	073500141
42	8	280	234.00	1	073500142
43	9	287	234.00	1	073500143
44	10	294	234.00	1	073500144
45	10,5	300	234.00	1	073500145
46	11	307	234.00	1	073500146
47	12	314	234.00	1	073500147



CE

S3 HRO SRC

HEAVY DUTY



7293HM

Chaussure basse en cuir pleine fleur gras hydrofuge avec semelle extérieure en caoutchouc VIBRAM® à hautes prestations, insert anti-abrasion sur le talon et couvre-embout renforcé en polyuréthane

- Embout en fibre de verre
- Semelle anti-perforation en fibre composite

EN ISO 20345 2011

11



EU	UK	mm	CHF		
39	6	263	236.00	1	072930639
40	6,5	270	236.00	1	072930640
41	7	276	236.00	1	072930641
42	8	283	236.00	1	072930642
43	9	289	236.00	1	072930643
44	10	296	236.00	1	072930644
45	10,5	302	236.00	1	072930645
46	11	309	236.00	1	072930646
47	12	315	236.00	1	072930647
48	13	322	236.00	1	072930648



CE

S3 HRO HI SRC

7293HN

Chaussure basse en Nubuck hydrofuge avec SUPPORT SYSTEM pour le maintien latéral de la cheville. Semelle extérieure en caoutchouc à haute résistance et embout en PU. Chaussure large.

- Embout en acier
- Semelle anti-perforation en fibre composite

EN ISO 20345 2011

11



E	U	mm	CHF		
39	6	256	186.50	1	072930839
40	6,5	263	186.50	1	072930840
41	7	269	186.50	1	072930841
42	8	276	186.50	1	072930842
43	9	282	186.50	1	072930843
44	10	289	186.50	1	072930844
45	10,5	295	186.50	1	072930845
46	11	302	186.50	1	072930846
47	12	308	186.50	1	072930847



CE

S3 HRO HI SRC

7294HM

Chaussure montante en cuir pleine fleur gras hydrofuge avec semelle extérieure en caoutchouc VIBRAM® ad à hautes prestations, insert anti-abrasion sur le talon et couvre-embout renforcé en polyuréthane

- Embout en fibre de verre
- Semelle anti-perforation en fibre composite

**EN ISO
20345
2011**



EU	UK	mm	CHF		
39	6	263	249.50	1	072940639
40	6,5	270	249.50	1	072940640
41	7	276	249.50	1	072940641
42	8	283	249.50	1	072940642
43	9	289	249.50	1	072940643
44	10	296	249.50	1	072940644
45	10,5	302	249.50	1	072940645
46	11	309	249.50	1	072940646
47	12	315	249.50	1	072940647
48	13	322	249.50	1	072940648

CE



S3 HRO HI SRC

7294HMC

Chaussure montante en cuir pleine fleur gras hydrofuge avec semelle extérieure en caoutchouc VIBRAM® à hautes prestations, embout anti-abrasion sur le talon et couvre-embout renforcé en polyuréthane. Dotée de membrane Tepon, résistante à l'eau et au vent et extrêmement respirante

- Embout en fibre de verre
- Semelle anti-perforation en fibre composite

**EN ISO
20345
2011**



EU	UK	mm	CHF		
39	6	263	278.00	1	072940739
40	6,5	270	278.00	1	072940740
41	7	276	278.00	1	072940741
42	8	283	278.00	1	072940742
43	9	289	278.00	1	072940743
44	10	296	278.00	1	072940744
45	10,5	302	278.00	1	072940745
46	11	309	278.00	1	072940746
47	12	315	278.00	1	072940747
48	13	322	278.00	1	072940748

CE



S3 HRO HI CI WR SRC

7294HN

Chaussure montante en Nubuck hydrofuge à délaçage rapide avec SUPPORT SYSTEM pour le maintien latéral de la cheville. Semelle extérieure en caoutchouc à haute résistance et embout en PU. Chaussure large

- Embout en acier
- Semelle anti-perforation en fibre composite

**EN ISO
20345
2011**



EU	UK	mm	CHF		
39	6	263	191.50	1	072940839
40	6,5	269	191.50	1	072940840
41	7	276	191.50	1	072940841
42	8	282	191.50	1	072940842
43	9	289	191.50	1	072940843
44	10	295	191.50	1	072940844
45	10,5	302	191.50	1	072940845
46	11	308	191.50	1	072940846
47	12	315	191.50	1	072940847

CE



S3 HRO HI RS SRC

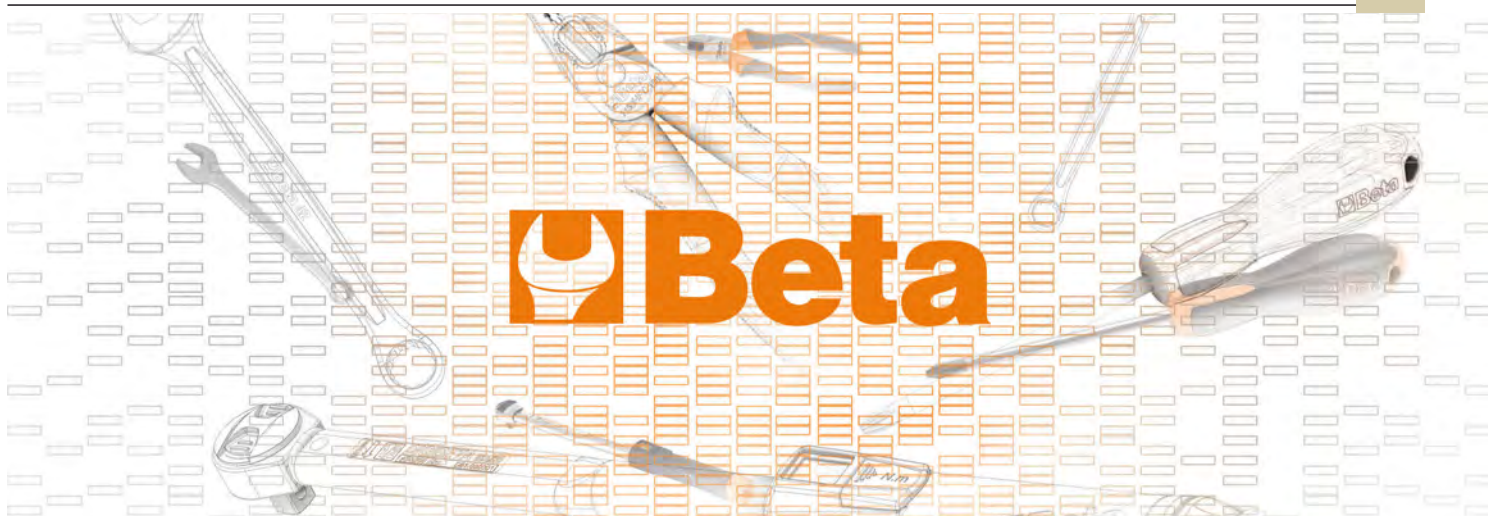

ACCESSORIES

7398 O/G

Semelle intérieure anatomique en mousse EVA avec coussinet amortissant dans la zone du talon (pièce de rechange préconisée pour la ligne de chaussures 0-Gravity)



EU	UK	CHF		
38	5	9.55	1	073981238
39	6	9.55	1	073981239
40	6,5	9.55	1	073981240
41	7	9.55	1	073981241
42	8	9.55	1	073981242
43	9	9.55	1	073981243
44	10	9.55	1	073981244
45	10,5	9.55	1	073981245
46	11	9.55	1	073981246
47	12	9.55	1	073981247
48	13	9.55	1	073981248

7398ESD

Semelle intérieure de propreté anatomique, couche supérieure respirante et antibactérienne, empêche la formation de mauvaises odeurs. Remplacement pour chaussures avec certification ESD (ElectroStatic Discharge)



EU	UK	CHF		
35	2,5	11.00	1	073981435
36	3,5	11.00	1	073981436
37	4,5	11.00	1	073981437
38	5	11.00	1	073981438
39	6	11.00	1	073981439
40	6,5	11.00	1	073981440
41	7	11.00	1	073981441
42	8	11.00	1	073981442
43	9	11.00	1	073981443
44	10	11.00	1	073981444
45	10,5	11.00	1	073981445
46	11	11.00	1	073981446
47	12	11.00	1	073981447
48	13	11.00	1	073981448

7398T

Semelle anatomique WINTHERM, 70% polyester aluminisé, 30% polyéthylène, fabriqués en fibres synthétiques non tissées. Antistatique, respirante, absorbante, anti-odeur, antibactérien, antifongicide.



WINTHERM

EU	UK	CHF		
35	2,5	19.10	1	073981335
36	3,5	19.10	1	073981336
37	4,5	19.10	1	073981337
38	5	19.10	1	073981338
39	6	19.10	1	073981339
40	6,5	19.10	1	073981340
41	7	19.10	1	073981341
42	8	19.10	1	073981342
43	9	19.10	1	073981343
44	10	19.10	1	073981344
45	10,5	19.10	1	073981345
46	11	19.10	1	073981346
47	12	19.10	1	073981347
48	13	19.10	1	073981348

7398U

Semelle intérieure anatomique en TPR GEL avec effet amortissant prononcé, support de la voûte plantaire et coussinet dans la zone du talon



EU	UK	CHF		
36 - 40	3,5 - 6,5	17.70	1	073980058
41 - 46	7 - 11	17.70	1	073980063

7398UP

Semelles anatomique en TPE GEL parfumé aux agrumes, avec support de la voûte plantaire



EU	UK	CHF		
36 - 40	3,5 - 6	16.10	1	073980076
41 - 46	7 - 11	16.10	1	073980081

7398GEL

semelles anatomiques avec insert en gel



EU	UK	CHF		
35	2,5	5.85	1	073980835
36	3,5	5.85	1	073980836
37	4,5	5.85	1	073980837
38	5	5.85	1	073980838
39	6	5.85	1	073980839
40	6,5	5.85	1	073980840
41	7	5.85	1	073980841
42	8	5.85	1	073980842
43	9	5.85	1	073980843
44	10	5.85	1	073980844
45	10,5	5.85	1	073980845
46	11	5.85	1	073980846
47	12	5.85	1	073980847
48	13	5.85	1	073980848

7398EF

Semelle intérieure anatomique en mousse de polyuréthane avec talonnette amortissante



EU	UK	CHF		
35	2,5	11.20	1	073981135
36	3,5	11.20	1	073981136
37	4,5	11.20	1	073981137
38	5	11.20	1	073981138
39	6	11.20	1	073981139
40	6,5	11.20	1	073981140
41	7	11.20	1	073981141
42	8	11.20	1	073981142
43	9	11.20	1	073981143
44	10	11.20	1	073981144
45	10,5	11.20	1	073981145
46	11	11.20	1	073981146
47	12	11.20	1	073981147
48	13	11.20	1	073981148

7399 A/N...

Lot de 10 paires de lacets



cm	CHF		
100	21.10	1	073990010
120	24.80	1	073990012
140	30.00	1	073990017

Les prix indiqués se réfèrent aux 10 paires

7421

Chaussettes longues en éponge à élasto-compression renforcées en nylon et coton sur pointe et talon
Plante de pied en fibre de bambou, résistante, antimycotique et respirante



	EU	CHF		
M	39-42	22.40	1	074210002
L	43-46	22.40	1	074210004

7423

Chaussettes courtes à élasto-compression renforcées en nylon et coton sur pointe et talon
Plante de pied en fibre de bambou, résistante, antimycotique et respirante



	EU	CHF		
M	39-42	14.40	1	074230002
L	43-46	14.40	1	074230004

7425

Chaussettes courtes avec inserts en texture respirante renforcées en nylon/coton sur pointe et talon
Plante de pied en nylon tressé avec fibre de bambou, antimycotique et respirante



	EU	CHF		
M	39-42	14.70	1	074250002
L	43-46	14.70	1	074250004

7427

Chaussettes maxi sneaker avec inserts de protection et respirantes sur la zone du tibia et du cou-de-pied.
Renforts en nylon et coton sur pointe et talon et plante de pied en fibre de bambou, résistante, antimycotique et respirante



	EU	CHF		
M	39-42	12.40	1	074270002
L	43-46	12.40	1	074270004

7429

Chaussettes maxi sneaker avec inserts de protection respirantes sur la zone du tibia et du cou-de-pied.
Renforts en nylon et coton sur pointe et talon et plante de pied en fibre de bambou, résistante, antimycotique et respirante



	EU	CHF		
M	39-42	11.50	1	074290002
L	43-46	11.50	1	074290004

7431P

Deux paires de chaussettes sneaker avec inserts en texture respirante et renforts en nylon/coton sur pointe et talon.

Plante de pied en nylon tressé avec fibre de bambou, résistante, antimycotique et respirante.
Une paire couleur noir/orange et une paire couleur noir/gris.



	EU	CHF		
M	39-42	11.00	1	074310102
L	43-46	11.00	1	074310104



VÊTEMENTS TECHNIQUES



La ligne de vêtements de travail a su gagner au fil des ans la confiance et la préférence des professionnels les plus exigeants. Le succès obtenu a généré une évolution et un enrichissement constants de la gamme d'offre.

Les vêtements produits par Beta Utensili S.p.A. sont conformes à la norme suivante: **EN ISO 13688:2013**

L'EPI protège l'utilisateur contre les risques physiques légers, tels que : petites abrasions, rayons solaires, vent, froid, poussières non nocives et souillure par des matériaux non toxiques. Cette protection correspond à la catégorie I du D.-L. italien n°. 475 du 04/12/1992.

MODE D'EMPLOI ET CONSERVATION

Ce vêtement doit être endossé correctement afin qu'il protège les parties du corps de l'utilisateur. Il doit être conservé en un lieu frais et sec, dans son emballage d'origine, à l'abri des sources de chaleur, des rayons solaires, de la poussière et des agents.

RÉTRÉCISSEMENT

Toutes les fibres naturelles rétrécissent après lavage à l'eau - Le rétrécissement peut varier de 1 % à 5 % en fonction de différents paramètres, notamment le type de fibre et la température de l'eau.

CORRESPONDANCE DES TAILLES

		I F D E UK USA						I F D E UK USA							
HOMME	XS	46	38	42	40	30	32	FEMME	XS	38	34	32	34	6	2
	S	48	40	44	42	32	34		S	40	36	34	36	8	4
	M	50	42	46	44	34	36		M	42	38	36	38	10	6
	L	52	44	48	46	36	38		L	44	40	38	40	12	8
	XL	54	46	50	48	38	40		XL	46	42	40	42	14	10
	2XL	56	48	52	50	40	42		2XL	48	44	42	44	16	12
3XL	58	50	54	52	42	44	3XL	50	46	44	46	18	14		
4XL	60	52	56	54	44	46									

MESURES ANATOMIQUES EN ISO 13688:2013

HOMME

	XS	S	M	L	XL	2XL	3XL	4XL
A	88-92	92-96	96-104	104-108	108-116	116-124	124-132	132-140
B	79-83	83-87	87-91	91-95	95-100	100-107	107-112	112-120
H	158-164	164-170	170-176	176-182	182-188	188-194	194-200	200-206

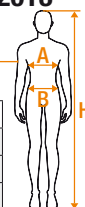

FEMME

	XS	S	M	L	XL	2XL	3XL
B	72-77	77-82	82-87	87-93	93-99	99-105	105-111
H	162-165	164-167	168-171	170-173	172-175	174-177	176-179

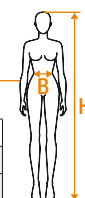

GUIDE DE SÉLECTION DES VÊTEMENTS PROGRAMME GÉNÉRAL 2023

Catégorie	Ligne	Code Article	Page	Couleur	Assortiments conseillés (tissus et couleurs identiques au pantalon)									
					Bermuda	Page	Cotte	Page	Combinaison	Page	Gilet	Page	Veste	Page
PANTALONS DE TRAVAIL LÉGERS	Trekking	7610G	614		7611G	618								
		7610N	614											
	Top Line	7660B	614		7661B	618								
		7660G	614		7661G	618								
	Stretch	7830SN	616		7831SN	618								
	Beta Easy	7860G	616		7861G	619	7863G	619	7865G	620	7867G	622	7869G	621
Cotton	7930G	617		7931G	619	7933G	620	7935G	620			7939G	621	
PANTALONS DE TRAVAIL MULTI-SAISONS	Trekking	7600G	613											
		7600N	613											
	Top Line	7650	614									7653G	620	
		7650B	614											
		7818BL	615											
		7818CM	615		7815CM	618								
		7818G	615											
	Stretch	7830ST	616		7831ST	618								
	Beta Easy	7840BL	616									7849BL	620	
	Stretch	7880SC	616											
	Beta Easy	7900B	617										7909B	621
		7900G	617		7901G	619	7903G	619	7905G	620	7907G	622	7909G	621
		7900P	617				7903P	619			7907P	622	7909P	621
7900V		617										7909V	621	
Multi-protection	7940	617										7949	621	
Lady	7818LN	615												

PANTS



7527

Jean de travail en tissu 70 % coton, 27 % polyester et 3 % stretch
Regular fit

CE

Jeans



	I	CHF		
XS	46	71.00	1	075270046
S	48	71.00	1	075270048
M	50	71.00	1	075270050
L	52	71.00	1	075270052
XL	54	71.00	1	075270054
XXL	56	71.00	1	075270056
XXXL	58	71.00	1	075270058

7528

Pantalon jeans de travail élastifié, 98 % coton et 2 % tissu élastifié, Portabilité sèche

CE

Jeans



	I	CHF		
XS	46	78.00	1	075280046
S	48	78.00	1	075280048
M	50	78.00	1	075280050
L	52	78.00	1	075280052
XL	54	78.00	1	075280054
XXL	56	78.00	1	075280056
XXXL	58	78.00	1	075280058

7530

Pantalon jeans de travail extensible, 98 % coton et 2 % tissu stretch, avec renforts en polyester
Slim fit

CE

Jeans



	I	CHF		
XS	46	91.50	1	075300046
S	48	91.50	1	075300048
M	50	91.50	1	075300050
L	52	91.50	1	075300052
XL	54	91.50	1	075300054
XXL	56	91.50	1	075300056
XXXL	58	91.50	1	075300058

7600G

Pantalon "work trekking" HEAVY 90 % nylon, 10 % tissu stretch, 265 g/m², tissu renforcé sur les genoux et le dos, bas de jambes élastiqué avec fermeture éclair verticale Gris foncé avec détails vert fluo
Portabilité sèche

CE

TREKKING HEAVY



	I	CHF		
XS	46	95.50	1	076000000
S	48	95.50	1	076000001
M	50	95.50	1	076000002
L	52	95.50	1	076000003
XL	54	95.50	1	076000004
XXL	56	95.50	1	076000005
XXXL	58	95.50	1	076000006

7600N

Pantalon "work trekking" HEAVY 90 % nylon, 10 % tissu stretch, 265 g/m², tissu renforcé sur les genoux et le dos, bas de jambes élastiqué avec fermeture éclair verticale Noir avec détails vert fluo
Portabilité sèche

CE

TREKKING HEAVY



	I	CHF		
XS	46	95.50	1	076000100
S	48	95.50	1	076000101
M	50	95.50	1	076000102
L	52	95.50	1	076000103
XL	54	95.50	1	076000104
XXL	56	95.50	1	076000105
XXXL	58	95.50	1	076000106

7610G

Pantalon "work trekking" LIGHT
90 % nylon, 10 % tissu 10 stretch, 140 g/m²,
tissu renforcé aux genoux et au dos, bas de
jambe élastiqué et réglable par cordons de
serrage Gris foncé avec détails jaunes
Portabilité sèche

CE

TREKKING
LIGHT



taille	l	CHF	👤	📄
XS	46	93.00	1	076100000
S	48	93.00	1	076100001
M	50	93.00	1	076100002
L	52	93.00	1	076100003
XL	54	93.00	1	076100004
XXL	56	93.00	1	076100005
XXXL	58	93.00	1	076100006

7610N

Pantalon "work trekking" LIGHT
90 % nylon, 10 % tissu 10 stretch, 140 g/m²,
tissu renforcé aux genoux et au dos, bas de
jambe élastiqué et réglable par cordon de
serrage Noir avec détails jaunes
Portabilité sèche

CE

TREKKING
LIGHT



taille	l	CHF	👤	📄
XS	46	93.00	1	076100100
S	48	93.00	1	076100101
M	50	93.00	1	076100102
L	52	93.00	1	076100103
XL	54	93.00	1	076100104
XXL	56	93.00	1	076100105
XXXL	58	93.00	1	076100106

7650

Pantalon de travail multipoches élastique
90 % nylon - 10 % spandex, 260 g/m², gris
anthracite
Poches pour genouillères, poches arrière et
bas de jambe renforcés en
polyester 600D, entrejambe antidéchirure

CE



TOP
line



taille	l	CHF	👤	📄
XS	46	121.00	1	076500000
S	48	121.00	1	076500001
M	50	121.00	1	076500002
L	52	121.00	1	076500003
XL	54	121.00	1	076500004
XXL	56	121.00	1	076500005
XXXL	60	121.00	1	076500006

7650B

pantalon de travail stretch, multipoches,
90 % nylon - 10 % élasthanne, 260 g/m², bleu
Poches pour genouillères, poches arrière et
bas de jambe renforcées en polyester 600D,
rempiècement à l'entrejambe

CE



TOP
line



taille	l	CHF	👤	📄
XS	46	121.00	1	076500100
S	48	121.00	1	076500101
M	50	121.00	1	076500102
L	52	121.00	1	076500103
XL	54	121.00	1	076500104
XXL	56	121.00	1	076500105
XXXL	58	121.00	1	076500106

7660B

pantalon de travail Bleu stretch, léger,
multipoches, 86% nylon - 14% élasthanne,
140 g / m², Poches pour genouillères,
poches arrière renforcées en polyester 300D,
Rempiècement à l'entrejambe.
Coupe ajustée

CE



TOP
line



taille	l	CHF	👤	📄
XS	46	104.00	1	076600100
S	48	104.00	1	076600101
M	50	104.00	1	076600102
L	52	104.00	1	076600103
XL	54	104.00	1	076600104
XXL	56	104.00	1	076600105
XXXL	58	104.00	1	076600106

7660G

pantalon de travail Gris stretch, léger,
multipoches, 86% nylon - 14% élasthanne,
140 g / m², Poches pour genouillères,
poches arrière renforcées en polyester 300D,
Rempiècement à l'entrejambe.
Coupe ajustée

CE



TOP
line



taille	l	CHF	👤	📄
XS	46	104.00	1	076600000
S	48	104.00	1	076600001
M	50	104.00	1	076600002
L	52	104.00	1	076600003
XL	54	104.00	1	076600004
XXL	56	104.00	1	076600005
XXXL	58	104.00	1	076600006

7818G

Pantalon de travail multipoches en T/C canvas, 260 g/m², gris
Poches pour genouillères et bas de jambes renforcés en polyester 300D, entrejambe antidéchirure et inserts en tissu extensible à l'intérieur de la jambe et dans la zone lombaire pour faciliter le mouvement



taille	I	CHF	🛒	📄
XS	46	93.00	1	078180000
S	48	93.00	1	078180001
M	50	93.00	1	078180002
L	52	93.00	1	078180003
XL	54	93.00	1	078180004
XXL	56	93.00	1	078180005
XXXL	58	93.00	1	078180006



7818BL

Pantalon de travail multipoches en T/C canvas, 260 g/m², bleu Insert en tissu extensible à l'intérieur de la jambe
Poches pour genouillères et bas de jambes renforcés en polyester 300D, entrejambe antidéchirure et inserts en tissu extensible à l'intérieur de la jambe et dans la zone lombaire pour faciliter le mouvement

CE



taille	I	CHF	🛒	📄
XS	46	93.00	1	078180100
S	48	93.00	1	078180101
M	50	93.00	1	078180102
L	52	93.00	1	078180103
XL	54	93.00	1	078180104
XXL	56	93.00	1	078180105
XXXL	58	93.00	1	078180106

7818CM

Pantalon de travail multipoches en T/C canvas, 260 g/m², gris camouflage
Poches pour genouillères et bas de jambes renforcés en polyester 300D, empiècement à l'entrejambe et inserts en tissu extensible dans l'entrejambe et dans la zone lombaire pour faciliter le mouvement

CE



taille	I	CHF	🛒	📄
XS	46	98.00	1	078180300
S	48	98.00	1	078180301
M	50	98.00	1	078180302
L	52	98.00	1	078180303
XL	54	98.00	1	078180304
XXL	56	98.00	1	078180305
XXXL	58	98.00	1	078180306

7818LN

Pantalon de travail multipoches pour femme, noir avec inserts roses, 100% coton extensible, 220 g/m² Poches pour genouillères et bas de jambes renforcés en polyester 300D, rempiècement à l'entrejambe et insert en tissu extensible à l'intérieur de la jambe pour faciliter le mouvement

CE

lady



taille	I	CHF	🛒	📄
XS	38	93.00	1	078180200
S	40	93.00	1	078180201
M	42	93.00	1	078180202
L	44	93.00	1	078180203
XL	46	93.00	1	078180204
XXL	48	93.00	1	078180205
XXXL	50	93.00	1	078180206

7830SN

Pantalon de travail extensible
en T/C twill, 200 g/m², noir
Coupe slim, rempiècement à l'entrejambe et
taille extensible sur les côtes

CE

STRETCH



taille	I	CHF	👤	📦
XS	46	82.50	1	078300100
S	48	82.50	1	078300101
M	50	82.50	1	078300102
L	52	82.50	1	078300103
XL	54	82.50	1	078300104
XXL	56	82.50	1	078300105
XXXL	58	82.50	1	078300106

7830ST

pantalon de travail élastifié coupe ajustée
en T/C twill 250 g/m², gris
entrejambe antidéchirure et taille élastiquée

CE

STRETCH



taille	I	CHF	👤	📦
XS	46	82.50	1	078300000
S	48	82.50	1	078300001
M	50	82.50	1	078300002
L	52	82.50	1	078300003
XL	54	82.50	1	078300004
XXL	56	82.50	1	078300005
XXXL	58	82.50	1	078300006

7840BL

Pantalon de travail en T/C twill, 245 g/m², bleu
Taille élastiquée

CE

Beta EASY



taille	I	CHF	👤	📦
XS	46	53.50	1	078400100
S	48	53.50	1	078400101
M	50	53.50	1	078400102
L	52	53.50	1	078400103
XL	54	53.50	1	078400104
XXL	56	53.50	1	078400105
XXXL	58	53.50	1	078400106
XXXXL	60	53.50	1	078400107

7860G

Pantalon de travail léger
en T/C twill, 180 g/m², avec empiècements en
Oxford, gris
Nouveau design - Confort amélioré

CE

Beta EASY

LIGHT



taille	I	CHF	👤	📦
XS	46	68.00	1	078600800
S	48	68.00	1	078600801
M	50	68.00	1	078600802
L	52	68.00	1	078600803
XL	54	68.00	1	078600804
XXL	56	68.00	1	078600805
XXXL	58	68.00	1	078600806
XXXXL	60	68.00	1	078600807

7880SC

Pantalon de travail élastifié
en T/C canvas 290 g/m², noir
Coupe ajustée, entrejambe antidéchirure et
taille élastiquée

CE

STRETCH



taille	I	CHF	👤	📦
XS	46	84.00	1	078800000
S	48	84.00	1	078800001
M	50	84.00	1	078800002
L	52	84.00	1	078800003
XL	54	84.00	1	078800004
XXL	56	84.00	1	078800005
XXXL	58	84.00	1	078800006



7900B

Pantalon de travail
en T/C canvas, 260 g/m², avec empiècements
en Oxford, bleu

CE

BetaEASY



	I	CHF		
XS	46	75.50	1	079000700
S	48	75.50	1	079000701
M	50	75.50	1	079000702
L	52	75.50	1	079000703
XL	54	75.50	1	079000704
XXL	56	75.50	1	079000705
XXXL	58	75.50	1	079000706
XXXXL	60	75.50	1	079000707

7900G

Pantalon de travail
en T/C canvas, 260 g/m², avec empiècements
en Oxford, gris
Nouveau design - Confort amélioré

CE

BetaEASY



	I	CHF		
XS	46	75.50	1	079000800
S	48	75.50	1	079000801
M	50	75.50	1	079000802
L	52	75.50	1	079000803
XL	54	75.50	1	079000804
XXL	56	75.50	1	079000805
XXXL	58	75.50	1	079000806
XXXXL	60	75.50	1	079000807

7900P

Pantalon de travail
en T/C canvas, 260 g/m², avec empiècements
en Oxford, bleu pétrole

CE

BetaEASY



	I	CHF		
XS	46	75.50	1	079000600
S	48	75.50	1	079000601
M	50	75.50	1	079000602
L	52	75.50	1	079000603
XL	54	75.50	1	079000604
XXL	56	75.50	1	079000605
XXXL	58	75.50	1	079000606
XXXXL	60	75.50	1	079000607

7900V

Pantalon de travail
en T/C canvas, 260 g/m², avec empiècements
en Oxford, vert

CE

BetaEASY



	I	CHF		
XS	46	75.50	1	079000500
S	48	75.50	1	079000501
M	50	75.50	1	079000502
L	52	75.50	1	079000503
XL	54	75.50	1	079000504
XXL	56	75.50	1	079000505
XXXL	58	75.50	1	079000506
XXXXL	60	75.50	1	079000507

7930G

Pantalon de travail
97% coton, 3% tissu élastiqué, 220 g/m²
Slim Fit

CE

Cotton



	I	CHF		
XS	46	82.50	1	079300300
S	48	82.50	1	079300301
M	50	82.50	1	079300302
L	52	82.50	1	079300303
XL	54	82.50	1	079300304
XXL	56	82.50	1	079300305
XXXL	58	82.50	1	079300306

7940

pantalon de travail multi-protection
250 g / m², bleu,
pour la protection contre la chaleur, les
flammes, les effets d'arc électrique, les risques
de soudage et les produits chimiques.

CE



7949



621

DPI: III^A Categoria
EN ISO 11611:2015 - Classe 1
EN ISO 11612:2015 - A1 B1 C1
EN 1149-5:2018
EN13034:2005+A1:2009 - Type 6
IEC 61482-2:2018 - APC 1

	I	CHF		
XS	46	110.50	1	079400000
S	48	110.50	1	079400001
M	50	110.50	1	079400002
L	52	110.50	1	079400003
XL	54	110.50	1	079400004
XXL	56	110.50	1	079400005
XXXL	58	110.50	1	079400006
XXXXL	60	110.50	1	079400007

BERMUDA



7529

Bermuda jeans de travail élastifié
98 % coton et 2 % tissu élastifié
Portabilité sèche

CE

Jeans



taille		CHF		
XS	46	62.50	1	075290046
S	48	62.50	1	075290048
M	50	62.50	1	075290050
L	52	62.50	1	075290052
XL	54	62.50	1	075290054
XXL	56	62.50	1	075290056
XXXL	58	62.50	1	075290058

7611G

Bermuda "work trekking" LIGHT
90 % nylon, 10 % tissu stretch, 140 g/m²,
tissu renforcé au dos.
Gris foncé avec détails jaunes
Portabilité sèche

CE

TREKKING
LIGHT



taille		CHF		
XS	46	71.00	1	076110000
S	48	71.00	1	076110001
M	50	71.00	1	076110002
L	52	71.00	1	076110003
XL	54	71.00	1	076110004
XXL	56	71.00	1	076110005
XXXL	58	71.00	1	076110006

7661B

Bermuda de travail Bleu stretch, léger, style multipoches,
86% nylon - 14% élasthanne, 140 g / m²,
Poches arrière renforcées en polyester 300D,
entrejambe indéchirable
Coupe ajustée

CE



TOP
line



taille		CHF		
XS	46	90.50	1	076610100
S	48	90.50	1	076610101
M	50	90.50	1	076610102
L	52	90.50	1	076610103
XL	54	90.50	1	076610104
XXL	56	90.50	1	076610105
XXXL	58	90.50	1	076610106

7661G

Bermuda de travail Gris stretch, léger, style multipoches,
86% nylon - 14% élasthanne, 140 g / m²,
Poches arrière renforcées en polyester 300D,
entrejambe indéchirable
Coupe ajustée

CE



TOP
line



taille		CHF		
XS	46	90.50	1	076610000
S	48	90.50	1	076610001
M	50	90.50	1	076610002
L	52	90.50	1	076610003
XL	54	90.50	1	076610004
XXL	56	90.50	1	076610005
XXXL	58	90.50	1	076610006

Beta

7815CM

bermuda de travail multipoches en T/C
canvas, 260 g/m², gris camouflage,
empiècement à l'entrejambe et inserts en tissu
extensible dans l'entrejambe et dans la zone
lombaire pour faciliter le mouvement

CE



taille		CHF		
XS	46	76.50	1	078150300
S	48	76.50	1	078150301
M	50	76.50	1	078150302
L	52	76.50	1	078150303
XL	54	76.50	1	078150304
XXL	56	76.50	1	078150305
XXXL	58	76.50	1	078150306

7831SN

Bermuda de travail extensible
en T/C twill, 200 g/m², noir
Coupe slim, rempliement à l'entrejambe et
taille extensible sur les côtes

CE



taille		CHF		
XS	46	63.00	1	078310100
S	48	63.00	1	078310101
M	50	63.00	1	078310102
L	52	63.00	1	078310103
XL	54	63.00	1	078310104
XXL	56	63.00	1	078310105
XXXL	58	63.00	1	078310106

7831ST

Bermuda de travail élastifié
en T/C twill 250 g/m², gris
Coupe ajustée, entrejambe antidéchirure et
taille élastifié

CE



taille		CHF		
XS	46	63.00	1	078310000
S	48	63.00	1	078310001
M	50	63.00	1	078310002
L	52	63.00	1	078310003
XL	54	63.00	1	078310004
XXL	56	63.00	1	078310005
XXXL	58	63.00	1	078310006

7861G

Bermuda de travail léger
en T/C twill, 180 g/m², avec empiècements en
Oxford, gris
Nouveau design - Confort amélioré

BetaEASY

CE **LIGHT**



	I	CHF		
XS	46	57.00	1	078610800
S	48	57.00	1	078610801
M	50	57.00	1	078610802
L	52	57.00	1	078610803
XL	54	57.00	1	078610804
XXL	56	57.00	1	078610805
XXXL	58	57.00	1	078610806
XXXXL	60	57.00	1	078610807

7901G

Bermuda de travail
en T/C canvas, 260 g/m², avec empiècements
en Oxford, gris
Nouveau design - Confort amélioré

BetaEASY

CE



	I	CHF		
XS	46	61.50	1	079010800
S	48	61.50	1	079010801
M	50	61.50	1	079010802
L	52	61.50	1	079010803
XL	54	61.50	1	079010804
XXL	56	61.50	1	079010805
XXXL	58	61.50	1	079010806
XXXXL	60	61.50	1	079010807

7931G

Bermuda de travail
100 % coton élastique, 220 g/m²
Slim Fit

CE **Cotton**



	I	CHF		
XS	46	63.00	1	079310300
S	48	63.00	1	079310301
M	50	63.00	1	079310302
L	52	63.00	1	079310303
XL	54	63.00	1	079310304
XXL	56	63.00	1	079310305
XXXL	58	63.00	1	079310306

OVERALLS

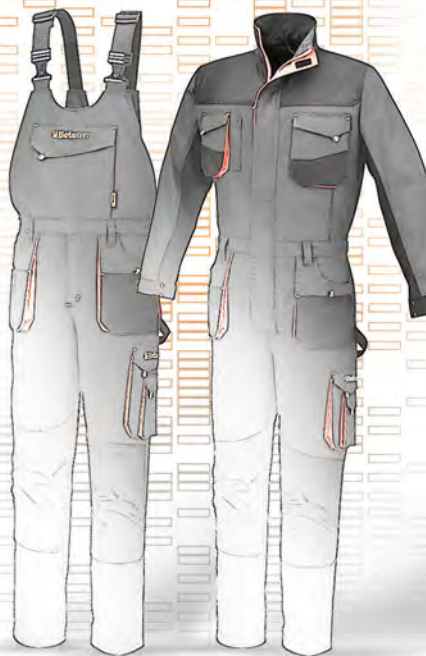

7863G

Cotte de travail légère
en T/C twill, 180 g/m², avec empiècements en
Oxford, grise
Nouveau design - Confort amélioré

BetaEASY

CE **LIGHT**



	I	CHF		
XS	46	84.00	1	078630800
S	48	84.00	1	078630801
M	50	84.00	1	078630802
L	52	84.00	1	078630803
XL	54	84.00	1	078630804
XXL	56	84.00	1	078630805
XXXL	58	84.00	1	078630806
XXXXL	60	84.00	1	078630807

7903G

Cotte de travail
en T/C canvas, 260 g/m², avec empiècements
en Oxford, grise
Nouveau design - Confort amélioré

CE **BetaEASY**



	I	CHF		
XS	46	95.00	1	079030800
S	48	95.00	1	079030801
M	50	95.00	1	079030802
L	52	95.00	1	079030803
XL	54	95.00	1	079030804
XXL	56	95.00	1	079030805
XXXL	58	95.00	1	079030806
XXXXL	60	95.00	1	079030807

7903P

Cotte de travail
en T/C canvas, 260 g/m², avec empiècements
en Oxford, bleu pétrole

BetaEASY

CE



	I	CHF		
XS	46	95.00	1	079030600
S	48	95.00	1	079030601
M	50	95.00	1	079030602
L	52	95.00	1	079030603
XL	54	95.00	1	079030604
XXL	56	95.00	1	079030605
XXXL	58	95.00	1	079030606
XXXXL	60	95.00	1	079030607

7933G

Cotte de travail
100 % coton élastiqué, 220 g/m²
Slim Fit



	CHF		
XS	102.50	1	079330300
S	102.50	1	079330301
M	102.50	1	079330302
L	102.50	1	079330303
XL	102.50	1	079330304
XXL	102.50	1	079330305
XXXL	102.50	1	079330306

7865G

Combinaison de travail légère
en T/C twill, 180 g/m², avec empiècements en
Oxford, grise
Nouveau design - Confort amélioré



	CHF		
XS	109.00	1	078650800
S	109.00	1	078650801
M	109.00	1	078650802
L	109.00	1	078650803
XL	109.00	1	078650804
XXL	109.00	1	078650805
XXXL	109.00	1	078650806
XXXXL	109.00	1	078650807

7905G

Combinaison de travail
en T/C canvas, 260 g/m², avec empiècements
en Oxford, grise
Nouveau design - Confort amélioré



CE



	CHF		
XS	118.50	1	079050800
S	118.50	1	079050801
M	118.50	1	079050802
L	118.50	1	079050803
XL	118.50	1	079050804
XXL	118.50	1	079050805
XXXL	118.50	1	079050806
XXXXL	118.50	1	079050807

7935G

Combinaison de travail
100 % coton élastiqué, 220 g/m²
Slim Fit



	CHF		
XS	138.00	1	079350300
S	138.00	1	079350301
M	138.00	1	079350302
L	138.00	1	079350303
XL	138.00	1	079350304
XXL	138.00	1	079350305
XXXL	138.00	1	079350306

WORK JACKETS



7653G

Veste de travail extensible multipoches
90% nylon -10% spandex, 260 g/m², gris
anthracite

CE



	CHF		
XS	121.50	1	076530000
S	121.50	1	076530001
M	121.50	1	076530002
L	121.50	1	076530003
XL	121.50	1	076530004
XXL	121.50	1	076530005
XXXL	121.50	1	076530006

7849BL

Veste de travail en T/C twill, 245 g/m², bleu
Taille élastiquée

CE



	CHF		
XS	57.00	1	078490100
S	57.00	1	078490101
M	57.00	1	078490102
L	57.00	1	078490103
XL	57.00	1	078490104
XXL	57.00	1	078490105
XXXL	57.00	1	078490106
XXXXL	57.00	1	078490107

7869G

Veste de travail légère
en T/C twill, 180 g/m², avec empiècements en
Oxford, grise
Nouveau design - Confort amélioré

CE

Beta EASY

LIGHT



	CHF		
XS	74.00	1	078690800
S	74.00	1	078690801
M	74.00	1	078690802
L	74.00	1	078690803
XL	74.00	1	078690804
XXL	74.00	1	078690805
XXXL	74.00	1	078690806
XXXXL	74.00	1	078690807

7909B

Veste de travail
en T/C canvas, 260 g/m², avec empiècements
en Oxford, bleu

CE

Beta EASY



	CHF		
XS	84.00	1	079090700
S	84.00	1	079090701
M	84.00	1	079090702
L	84.00	1	079090703
XL	84.00	1	079090704
XXL	84.00	1	079090705
XXXL	84.00	1	079090706
XXXXL	84.00	1	079090707

7909G

Veste de travail
en T/C canvas, 260 g/m², avec empiècements
en Oxford, grise
Nouveau design - Confort amélioré

CE

Beta EASY



	CHF		
XS	84.00	1	079090800
S	84.00	1	079090801
M	84.00	1	079090802
L	84.00	1	079090803
XL	84.00	1	079090804
XXL	84.00	1	079090805
XXXL	84.00	1	079090806
XXXXL	84.00	1	079090807

7909P

Veste de travail
en T/C canvas, 260 g/m², avec empiècements
en Oxford, bleu pétrole

CE

Beta EASY



	CHF		
XS	84.00	1	079090600
S	84.00	1	079090601
M	84.00	1	079090602
L	84.00	1	079090603
XL	84.00	1	079090604
XXL	84.00	1	079090605
XXXL	84.00	1	079090606
XXXXL	84.00	1	079090607

7909V

Veste de travail
en T/C canvas, 260 g/m², avec empiècements
en Oxford, vert

CE

Beta EASY



	CHF		
XS	84.00	1	079090500
S	84.00	1	079090501
M	84.00	1	079090502
L	84.00	1	079090503
XL	84.00	1	079090504
XXL	84.00	1	079090505
XXXL	84.00	1	079090506
XXXXL	84.00	1	079090507

7939G

Veste de travail
100 % coton élastique, 220 g/m²
Slim Fit

CE

Cotton



	CHF		
XS	89.00	1	079390300
S	89.00	1	079390301
M	89.00	1	079390302
L	89.00	1	079390303
XL	89.00	1	079390304
XXL	89.00	1	079390305
XXXL	89.00	1	079390306

7949

veste de travail multi-protection,
250 g / m², bleu,
pour la protection contre la chaleur, les
flammes, les effets d'arc électrique, soudure et
produits chimiques.

CE

DPI: III* Categoria
EN ISO 11611:2015 - Classe 1
EN ISO 11612:2015 - A1 B1 C1
EN 1149-5:2018
EN13034:2005+A1:2009 - Type 6
IEC 61482-2:2018 - APC 1



	CHF		
XS	127.50	1	079490000
S	127.50	1	079490001
M	127.50	1	079490002
L	127.50	1	079490003
XL	127.50	1	079490004
XXL	127.50	1	079490005
XXXL	127.50	1	079490006
XXXXL	127.50	1	079490007



SLEEVELESS JACKETS



7575N

Gilet en Softshell
90 % nylon, 10 % tissu élastifié, 250 g/m²



TAILLE	CHF	👤	🏠
S	112.00	1	075750301
M	112.00	1	075750302
L	112.00	1	075750303
XL	112.00	1	075750304
XXL	112.00	1	075750305
XXXL	112.00	1	075750306

7579QN

Gilet de travail multipoches en double matière. 100% nylon imperméable 300D et tissu softshell 96 % polyester, 4 % spandex, matelassé en polyester 160 g/m² noir/gris anthracite

CE



TAILLE	CHF	👤	🏠
S	96.00	1	075790201
M	96.00	1	075790202
L	96.00	1	075790203
XL	96.00	1	075790204
XXL	96.00	1	075790205
XXXL	96.00	1	075790206

Beta

7673NG

veste de travail sans manches avec rembourrage en GRAPHENE, 80 g/m², torse renforcé en tissu softshell - 96 % polyester, 4% élasthanne et dos en 100 % nylon 20D gris anthracite (sur le devant), noir (sur le derrière)

Empiècement stretch aux emmanchures, antistatique, antibactérien et coupe-vent

CE

TOP
line



TAILLE	CHF	👤	🏠
S	123.00	1	076730001
M	123.00	1	076730002
L	123.00	1	076730003
XL	123.00	1	076730004
XXL	123.00	1	076730005
XXXL	123.00	1	076730006

7867G

Gilet de travail léger en T/C twill, 180 g/m², avec empiècements en Oxford, gris
Nouveau design - Confort amélioré

CE

LIGHT



TAILLE	CHF	👤	🏠
XS	63.50	1	078670800
S	63.50	1	078670801
M	63.50	1	078670802
L	63.50	1	078670803
XL	63.50	1	078670804
XXL	63.50	1	078670805
XXXL	63.50	1	078670806
XXXXL	63.50	1	078670807

7907G

Gilet de travail en T/C canvas, 260 g/m², avec empiècements en Oxford, gris
Nouveau design - Confort amélioré

CE

Beta EASY



TAILLE	CHF	👤	🏠
XS	70.00	1	079070800
S	70.00	1	079070801
M	70.00	1	079070802
L	70.00	1	079070803
XL	70.00	1	079070804
XXL	70.00	1	079070805
XXXL	70.00	1	079070806
XXXXL	70.00	1	079070807

7907P

Gilet de travail en T/C canvas, 260 g/m², avec empiècements en Oxford, bleu pétrole

CE

Beta EASY



TAILLE	CHF	👤	🏠
XS	70.00	1	079070600
S	70.00	1	079070601
M	70.00	1	079070602
L	70.00	1	079070603
XL	70.00	1	079070604
XXL	70.00	1	079070605
XXXL	70.00	1	079070606
XXXXL	70.00	1	079070607

Beta

JACKETS



7658CM

veste softshell, 94% polyester, 6% élasthanne, 290 g/m², gris camouflage
Avec membrane TPU imperméable, respirante et coupe-vent
(résistance aux colonnes d'eau jusqu'à 8 000 mm - respirabilité 8 000 mvp)

TOP
line



	CHF		
S	152.50	1	076580101
M	152.50	1	076580102
L	152.50	1	076580103
XL	152.50	1	076580104
XXL	152.50	1	076580105
XXXL	152.50	1	076580106

7658N

Veste en Softshell 94 % polyester, 6 % spandex, 290 g/m², gris anthracite
Munie de membrane TPU imperméabilisée, coupe-vent et transpirante
(résistance à colonnes d'eau 8.000 mm)

TOP
line



	CHF		
S	137.00	1	076580001
M	137.00	1	076580002
L	137.00	1	076580003
XL	137.00	1	076580004
XXL	137.00	1	076580005
XXXL	137.00	1	076580006

7659N

Veste en Softshell, 94 % polyester, 6 % spandex, 290 g/m², avec capuche et manches amovibles, noire
Munie de membrane TPU imperméabilisée, coupe-vent et transpirante

TOP
line



	CHF		
S	196.50	1	076590001
M	196.50	1	076590002
L	196.50	1	076590003
XL	196.50	1	076590004
XXL	196.50	1	076590005
XXXL	196.50	1	076590006

7669N

veste de travail noire extensible, légère, style multipoches, 86% nylon, 14% élasthanne, 140 g-m2,
Avec manches amovibles et capuche rétractable.
Résistant à l'eau, coupe-vent

4-WAY
STRETCH

TOP
line



	CHF		
XS	137.00	1	076690000
S	137.00	1	076690001
M	137.00	1	076690002
L	137.00	1	076690003
XL	137.00	1	076690004
XXL	137.00	1	076690005
XXXL	137.00	1	076690006

Beta

7670G

Anorak en polyester Oxford 300D, imperméable, enduit PU, gris anthracite
Avec capuche amovible et manches renforcées, coupe-vent et respirante
(résistance aux colonnes d'eau jusqu'à 2 000 mm - respirabilité 2 000 mvp)
Doublure en polyester 210T, rembourrage en polyester, corps en 120 g/m², manches en 100 g/m²

CE
TOP
line



	CHF		
S	137.00	1	076700001
M	137.00	1	076700002
L	137.00	1	076700003
XL	137.00	1	076700004
XXL	137.00	1	076700005
XXXL	137.00	1	076700006

7674NG

veste de travail matelassée avec rembourrage en GRAPHENE, 80 g/m², torse et avant-bras renforcés en tissu softshell - 96 % polyester, 4% élasthanne, dos et manches en 100 % nylon 20D, gris anthracite (sur le devant), noir (sur le derrière), poignets extensibles

CE
TOP
line



	CHF		
S	152.50	1	076740001
M	152.50	1	076740002
L	152.50	1	076740003
XL	152.50	1	076740004
XXL	152.50	1	076740005
XXXL	152.50	1	076740006

Beta

7780QN

Blouson bomber de travail multipoches en double matière.

100% nylon imperméable 300D et tissu softshell 96 % polyester, 4 % spandex, rembourrage en polyester 160 g/m² avec capuche fixe noir/gris anthracite

CE



	CHF		
S	163.00	1	077800201
M	163.00	1	077800202
L	163.00	1	077800203
XL	163.00	1	077800204
XXL	163.00	1	077800205
XXXL	163.00	1	077800206

7904N

Blouson bomber de travail rembourré en T/C canvas, 270 g/m², empiècements en "Oxford", noir

Rembourrage en polyester, 140 g/m²

CE

Beta EASY



	CHF		
XS	147.00	1	079040800
S	147.00	1	079040801
M	147.00	1	079040802
L	147.00	1	079040803
XL	147.00	1	079040804
XXL	147.00	1	079040805
XXXL	147.00	1	079040806
XXXXL	147.00	1	079040807

FLEECE



7637G

Sweat-shirt technique avec fermeture éclair longue, 250 g/m², avec capuche polaire 100 % polyester avec empiècements en tissu softshell 100D avec polaire couplé, 270 g/m² gris mélange/noir



	CHF		
XS	108.50	1	076370000
S	108.50	1	076370001
M	108.50	1	076370002
L	108.50	1	076370003
XL	108.50	1	076370004
XXL	108.50	1	076370005
XXXL	108.50	1	076370006

7635N

Pull en micro-polaire, 180 g/m², noir



	CHF		
XS	44.00	1	076350500
S	44.00	1	076350501
M	44.00	1	076350502
L	44.00	1	076350503
XL	44.00	1	076350504
XXL	44.00	1	076350505
XXXL	44.00	1	076350506

7654B

pull micropolaire stretch avec fermeture éclair courte, 180 g/m², bleu 95% polyester, 5% élasthanne



TOP line



	CHF		
XS	58.50	1	076540100
S	58.50	1	076540101
M	58.50	1	076540102
L	58.50	1	076540103
XL	58.50	1	076540104
XXL	58.50	1	076540105
XXXL	58.50	1	076540106

7654N

Pull en micro-polaire, fermeture éclair courte, élastique, 180 g/m², noir 95 % polyester, 5 % spandex



TOP line



	CHF		
XS	58.50	1	076540000
S	58.50	1	076540001
M	58.50	1	076540002
L	58.50	1	076540003
XL	58.50	1	076540004
XXL	58.50	1	076540005
XXXL	58.50	1	076540006

7657B

pull en molleton stretch avec fermeture éclair longue, 280 g/m², bleu 95% polyester, 5% élasthanne



TOP line



	CHF		
XS	74.00	1	076570100
S	74.00	1	076570101
M	74.00	1	076570102
L	74.00	1	076570103
XL	74.00	1	076570104
XXL	74.00	1	076570105
XXXL	74.00	1	076570106

Beta

7657N

Pull polaire, fermeture éclair longue, élastique, 280 g/m², noir, 95 % polyester, 5 % spandex



TOP line



	CHF		
XS	74.00	1	076570000
S	74.00	1	076570001
M	74.00	1	076570002
L	74.00	1	076570003
XL	74.00	1	076570004
XXL	74.00	1	076570005
XXXL	74.00	1	076570006

7664G

sweatshirt, longue fermeture éclair, 280 g/m², gris, 60 % coton, 40 % polyesters

TOP line



	CHF		
XS	67.50	1	076640100
S	67.50	1	076640101
M	67.50	1	076640102
L	67.50	1	076640103
XL	67.50	1	076640104
XXL	67.50	1	076640105
XXXL	67.50	1	076640106

7664N

sweatshirt avec fermeture éclair longue, 280 g/m², noir, 60 % coton, 40 % polyesters

TOP line



	CHF		
XS	67.50	1	076640000
S	67.50	1	076640001
M	67.50	1	076640002
L	67.50	1	076640003
XL	67.50	1	076640004
XXL	67.50	1	076640005
XXXL	67.50	1	076640006

7665G

sweatshirt à capuche, longue fermeture éclair, 280 g/m², gris, 60 % coton, 40 % polyester

TOP line



	CHF		
XS	73.00	1	076650100
S	73.00	1	076650101
M	73.00	1	076650102
L	73.00	1	076650103
XL	73.00	1	076650104
XXL	73.00	1	076650105
XXXL	73.00	1	076650106

7665N

sweatshirt à capuche, longue fermeture éclair, 280 g/m², noir, 60 % coton, 40 % polyester

TOP line



	CHF		
XS	73.00	1	076650000
S	73.00	1	076650001
M	73.00	1	076650002
L	73.00	1	076650003
XL	73.00	1	076650004
XXL	73.00	1	076650005
XXXL	73.00	1	076650006

SHIRT & T-SHIRT

7545F

Chemise flanelle de travail à carreaux, 100 % coton, 190 g/m²



	CHF		
XS	52.00	1	075450200
S	52.00	1	075450201
M	52.00	1	075450202
L	52.00	1	075450203
XL	52.00	1	075450204
XXL	52.00	1	075450205
XXXL	52.00	1	075450206

7547AZ

Polo 3 boutons, 100% coton, 200 g/m², bleu clair



	CHF		
XS	37.50	2	075470500
S	37.50	2	075470501
M	37.50	2	075470502
L	37.50	2	075470503
XL	37.50	2	075470504
XXL	37.50	2	075470505
XXXL	37.50	2	075470506

7547BL

Polo 3 boutons, 100 % coton 200 g/m², bleu



	CHF		
XS	37.50	2	075470200
S	37.50	2	075470201
M	37.50	2	075470202
L	37.50	2	075470203
XL	37.50	2	075470204
XXL	37.50	2	075470205
XXXL	37.50	2	075470206



7547G

Polo 3 boutons
100 % coton 200 g/m², gris



	CHF		
XS	37.50	2	075470300
S	37.50	2	075470301
M	37.50	2	075470302
L	37.50	2	075470303
XL	37.50	2	075470304
XXL	37.50	2	075470305
XXXL	37.50	2	075470306

7549AZ

T-shirt de travail, 100% coton, 150 g/m², bleu clair



	CHF		
XS	24.60	5	075490500
S	24.60	5	075490501
M	24.60	5	075490502
L	24.60	5	075490503
XL	24.60	5	075490504
XXL	24.60	5	075490505
XXXL	24.60	5	075490506

7549NE

T-shirt de travail en 100 % coton, 150 g/m², noir



	CHF		
XS	24.60	5	075490700
S	24.60	5	075490701
M	24.60	5	075490702
L	24.60	5	075490703
XL	24.60	5	075490704
XXL	24.60	5	075490705
XXXL	24.60	5	075490706

7547N

Polo 3 boutons
100% coton, 200 g/m², noir



	CHF		
XS	37.50	2	075470400
S	37.50	2	075470401
M	37.50	2	075470402
L	37.50	2	075470403
XL	37.50	2	075470404
XXL	37.50	2	075470405
XXXL	37.50	2	075470406

7549BL

T-shirt de travail 100 % coton, 150 g/m², bleu



	CHF		
XS	24.60	5	075490200
S	24.60	5	075490201
M	24.60	5	075490202
L	24.60	5	075490203
XL	24.60	5	075490204
XXL	24.60	5	075490205
XXXL	24.60	5	075490206

7549N

T-shirt de travail 100% coton, 150 g/m², noir



	CHF		
XS	24.60	5	075490400
S	24.60	5	075490401
M	24.60	5	075490402
L	24.60	5	075490403
XL	24.60	5	075490404
XXL	24.60	5	075490405
XXXL	24.60	5	075490406

7547R

Polo 3 boutons,
100% coton, 200 g/m², rouge



	CHF		
XS	37.50	2	075470600
S	37.50	2	075470601
M	37.50	2	075470602
L	37.50	2	075470603
XL	37.50	2	075470604
XXL	37.50	2	075470605
XXXL	37.50	2	075470606

7549G

T-shirt de travail 100 % coton, 150 g/m², gris



	CHF		
XS	24.60	5	075490300
S	24.60	5	075490301
M	24.60	5	075490302
L	24.60	5	075490303
XL	24.60	5	075490304
XXL	24.60	5	075490305
XXXL	24.60	5	075490306

7549R

T-shirt de travail, 100% coton, 150 g/m², rouge



	CHF		
XS	24.60	5	075490600
S	24.60	5	075490601
M	24.60	5	075490602
L	24.60	5	075490603
XL	24.60	5	075490604
XXL	24.60	5	075490605
XXXL	24.60	5	075490606

7550G

T-shirt de travail technique en polyester, 120 g/m² avec la technologie 37.5°, gris avec détails noirs, orange et réfléchissants.



	CHF		
XS	52.50	1	075500400
S	52.50	1	075500401
M	52.50	1	075500402
L	52.50	1	075500403
XL	52.50	1	075500404
XXL	52.50	1	075500405
XXXL	52.50	1	075500406

7550N

T-shirt de travail technique en polyester, 120 g/m² avec la technologie 37.5°, noir avec détails gris, orange et réfléchissants



	CHF		
XS	52.50	1	075500500
S	52.50	1	075500501
M	52.50	1	075500502
L	52.50	1	075500503
XL	52.50	1	075500504
XXL	52.50	1	075500505
XXXL	52.50	1	075500506

7557BL

Polo 3 boutons, manches longues, 100% cotton, 200 g/m², Bleu



	CHF		
XS	45.00	1	075570200
S	45.00	1	075570201
M	45.00	1	075570202
L	45.00	1	075570203
XL	45.00	1	075570204
XXL	45.00	1	075570205
XXXL	45.00	1	075570206

RAIN

7970

Pantalon en PVC Tricot, imperméable, bleu



EN 343

	CHF		
XS	57.00	1	079700000
S	57.00	1	079700001
M	57.00	1	079700002
L	57.00	1	079700003
XL	57.00	1	079700004
XXL	57.00	1	079700005
XXXL	57.00	1	079700006

7971L

Pantalon imperméable en polyester enduit PVC avec coutures étanches, bleu
Doté d'élastique à la taille et bas de jambe réglable avec boutons pression

CE



EN 343

	CHF		
XS	32.00	1	079710100
S	32.00	1	079710101
M	32.00	1	079710102
L	32.00	1	079710103
XL	32.00	1	079710104
XXL	32.00	1	079710105
XXXL	32.00	1	079710106

7978L

Manteau imperméable en polyester enduit PVC avec capuche fixe et coutures étanches, bleu
Doté de boutons pression qui permettent de le raccourcir à 3/4

CE



EN 343

	CHF		
XS	44.00	1	079780100
S	44.00	1	079780101
M	44.00	1	079780102
L	44.00	1	079780103
XL	44.00	1	079780104
XXL	44.00	1	079780105
XXXL	44.00	1	079780106



7979

Veste en PVC Tricot, imperméable, bleu

CE



EN 343

	CHF		
S	93.00	1	079790001
M	93.00	1	079790002
L	93.00	1	079790003
XL	93.00	1	079790004
XXL	93.00	1	079790005
XXXL	93.00	1	079790006

ACCESSORIES

7800G

Paire de genouillères de travail



	CHF		
7800G	18.90	1	078000500

7980N

Casquette anti-pluie
100 % polyester enduit PU
avec traitement hydrofuge



	CHF		
L = Ø 58 cm	16.00	1	079800058
XL = Ø 60 cm	16.00	1	079800060

7980NC

bonnet d'hiver polaire, 100 % polyester,
réversible, noir/camouflage



	CHF		
7980NC	16.60	10	079800112

7980R

Bonnet d'hiver avec revers, 100 % acrylique
rembourré en 3M Thinsulate™, noir



	CHF		
7980R	14.20	10	079800111

7984EG

ceinture de travail en tissu extensible avec
boucle à crochet en métal zinc satiné,
taille unique : longueur 120 cm,(peut être
raccourcie),largeur 37 mm



	CHF		
7984EG	32.50	1	079840520

7984G

Ceinture 100% TPE avec boucle en métal zinc
chromé
taille unique 125 cm réglable, largeur 35 mm,
noir



	CHF		
7984G	22.20	1	079840525

7985

Cache-cou en micro-polaire avec coulisse
réglable, noir
utilisable également comme bonnet



	CHF		
7985	16.80	10	079850111

7104 90

Colonnes en plastique avec base de
rangement



	H mm	CHF		
7104 90	90	33.00	4	071040004

7105 6

Chaîne en plastique de délimitation



	Ø mm	L m	CHF		
7105 6	6	25	78.50	1	071050006

UNDERWEAR

7996N

ensemble de sous-vêtements techniques -
maillot de corps manches longues + collant
technique, 92 % polyester, 8 % élasthanne,
160 g/m², noir



	CHF		
XS-S	53.50	1	079960000
M-L	53.50	1	079960002
XL-XXL	53.50	1	079960004

7109A

Panneaux d'avertissement en aluminium



	H mm	CHF		
7109A1	140	13.80	1	071090001
7109A2	140	13.80	1	071090002
7109A3	140	13.80	1	071090003
7109A4	140	13.80	1	071090004

7109D

Panneaux d'interdiction



	H mm	CHF		
7109D1	115	13.80	1	071090051
7109D2	115	13.80	1	071090052
7109D3	115	13.80	1	071090053

7195A

Masque antipoussière

CE



	CHF		
7195A	8.40	10	071950004

7061TC

Lunettes de protection avec verres en polycarbonate transparent

CE

EASY



EN166:2001
EN170
2C-1.2 1F

	CHF		
7061TC	12.20	1	070610001

7076BC

Lunettes de protection avec verres en polycarbonate transparent

CE

SPORT



EN166:2001
EN172
5-1.7 1F

	CHF		
7076BC	28.00	1	070760009

7076BD

Lunettes de protection avec verres en polycarbonate

CE

SPORT



EN166:2001
EN172
5-3.1 1F

	CHF		
7076BD	28.00	1	070760019

7076BP

Lunettes de protection avec verres en polycarbonate polarisé

CE

SPORT



EN ISO 12312-1:2013+A1:2015
EN 1836
3P

	CHF		
7076BP	44.00	1	070760029

7076BU

lunettes de sécurité avec verres en polycarbonate orange pour la détection des fuites avec lampe UV

CE



EN ISO 12311:2013
UV 500

	CHF		
7076BU	22.80	1	070760039

7093BC

Lunettes de protection avec verres en polycarbonate transparent

CE

IMPACT



EN166:2001
EN170
2C-1.2 1F

	CHF		
7093BC	41.50	1	070930009

7093BD

Lunettes de protection avec verres en polycarbonate foncé

CE

IMPACT



EN166:2001
EN172
5-3.1 1F

	CHF		
7093BD	41.50	1	070930019

C62M/W

Présentoir mannequin



185
cm

65 cm

	CHF		
C62M/W	694.00	1	062000361

6200M/B

en verre de rechange pour mannequins C62M/W



	CHF		
6200M/B	103.50	1	062000361

C64

présentoir mural pour vêtements et chaussures, vide



2400
mm

560
mm

L	CHF		
1 m	1,805.00	1	064000021
2 m	3,260.00	1	064000022
3 m	4,730.00	1	064000023
4 m	6,200.00	1	064000024



C64G

présentoir « gondole » pour vêtements et chaussures, vide

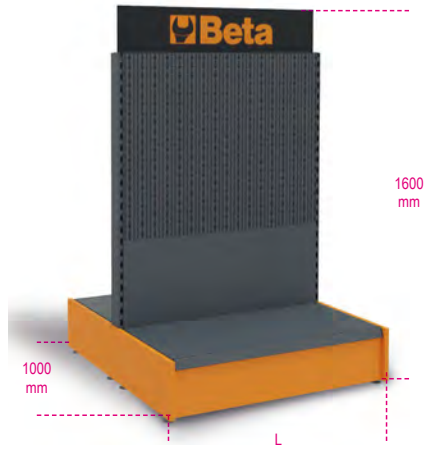

L	CHF		
1 m	2,215.00	1	064000051
2 m	4,020.00	1	064000052

C64CW

vestiaire



C64CW	CHF		
	773.00	1	064000610

6200AP/S10

Série de 10 cintres



6200AP/S10	CHF		
	56.00	1	062000331

6800BA



6800BA	CHF		
	153.00	1	068000130

6800RS



6800RS	CHF		
	132.00	1	068000135

6888GS

crochet de chaussure pour affichage C64



6888GS	CHF		
	33.00	2	068880122

170x120 mm

6888GW

crochet pour affichage C64



6888GW	CHF		
	8.55	2	068880121

400 mm

9562TB

Tapis pour essuyage chaussures, avec partie arrière en caoutchouc antiglisse



9562TB	L mm	H mm	CHF		
	800	600	60.00	1	095620500

9565S

Fût en tôle d'acier avec chaise en similicuir déhoussable.



9565S	H cm	ø cm	CHF		
	60	38	266.00	2	095650300

Beta



Robur

Robur fabrique depuis 1930 des lignes d'accessoires pour câbles dans la lignée de la qualité reconnue de Beta Utensili, dont elle complète la gamme de production.

L'expérience, l'organisation et la technologie sont à la base d'un développement constant à l'écoute des besoins du marché.

La marque Robur est produite depuis 1984 dans une usine moderne située à Sulmona



Formats de vente spéciaux pour libre service

CHARGE

WLL: charge constante (pour accessoires de levage)

WFL: force limite de travail (pour accessoires non destinés au levage)

BF: Force maximum atteinte par l'article lors de l'essai de traction statique

LC: tension d'ancrage

8147P

nouveauté 2023

Pince d'ancrage pour palans manuels

Adaptée aux poutres structurales INP, IPB, IPE, HEA, HEB, par exemple.

CE

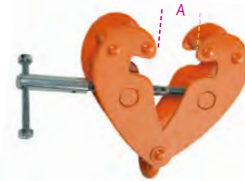

EN13157

Caractéristiques techniques :

- Coefficient de sécurité : 4
- Plaque d'identification du numéro de série

Certificats disponibles :

- certificat du fabricant
- Déclaration de Conformité CE
- rapport d'essai type 2.2 UNI EN10220
- spécifications techniques du produit

prix

dimensions

WLL t	A min mm	A max mm	CHF	code commande
1,0	90	180	137.00	1 081470210
2,0	90	190	165.50	1 081470220
3,0	85	280	280.00	1 081470230
5,0	85	280	408.00	1 081470250

conditionnement

8105
Tendeur à deux oeillets en acier allié galvanisé à chaud

CE



UNI11841:2022

- CARACTÉRISTIQUES TECHNIQUES**
- coefficient de sécurité : 5
 - traitement thermique cage : normalisation
 - traitement thermique œillets : bonification
- ANALYSES DE LABORATOIRE**
- analyse chimique
 - essai de traction
- CERTIFICATS DISPONIBLES**
- Spécification produit
 - Rapport d'essai type 2.2 UNI EN10204

ØxE	≈	WFL	CHF		
"	mm	kg			
3/8x6	M10x150	540	17.90	5	081050010
1/2x6	M12x150	1000	29.50	5	081050011
1/2x9	M12x230	1000	38.00	5	081050012
5/8x6	M16x150	1590	45.00	2	081050014
5/8x12	M16x300	1590	67.00	2	081050015
5/8x9	M16x230	1590	56.00	2	081050016
3/4x6	M20x150	2360	72.00	2	081050017
3/4x12	M20x300	2360	100.00	2	081050018
3/4x9	M20x230	2360	83.50	2	081050020
3/4x18	M20x460	2360	131.50	2	081050021
7/8x12	M22x300	3270	141.50	1	081050022
1x6	M24x150	4540	150.00	1	081050024
1x12	M24x300	4540	215.50	1	081050025
1x18	M24x460	4540	254.00	1	081050026
1.1/4x12	M33x300	6900	368.00	1	081050031
1.1/4x18	M33x460	6900	379.00	1	081050032
1.1/2x12	M39x300	9710	455.00	1	081050034
1.1/2x18	M39x460	9710	553.00	1	081050035
1.3/4x18	M45x460	12700	837.00	1	081050036

autres mesures disponibles sur demande

formats de vente spéciaux pour libre service



ØxE	CHF		
"			
3/8x6	19.50	1	081059010
1/2x9	39.50	1	081059012

Robur

Robur

8109
Tendeur à deux chapes en acier allié galvanisé à chaud

CE

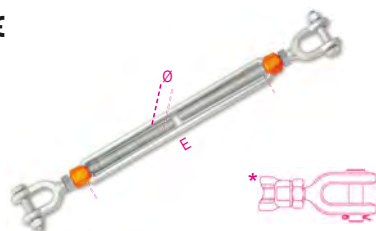

UNI 11841:2022

- CARACTÉRISTIQUES TECHNIQUES**
- coefficient de sécurité : 5
 - traitement thermique cage : normalisation
 - traitement thermique chapes : bonification
- ANALYSES DE LABORATOIRE**
- analyse chimique
 - essai de traction
- CERTIFICATS DISPONIBLES**
- Spécification produit
 - Rapport d'essai type 2.2 UNI EN10204

ØxE	≈	WFL	CHF		
"	mm	kg			
3/8x6	M10x150	540	23.20	5	081090010
1/2x6	M12x150	1000	38.50	5	081090011
1/2x9	M12x230	1000	46.00	5	081090012
1/2x12	M12x300	1000	58.00	5	081090013
5/8x6	M16x150	1590	70.00	2	081090015
5/8x9	M16x230	1590	83.00	2	081090016
5/8x12	M16x300	1590	93.00	2	081090017
3/4x6	M20x150	2360	98.00	2	081090018
3/4x9	M20x230	2360	113.50	2	081090020
3/4x12	M20x300	2360	126.50	2	081090019
3/4x18	M20x460	2360	150.50	2	081090021
7/8x12	M22x300	3270	189.50	1	081090022
7/8x18	M22x460	3270	229.50	1	081090023
1x6	M24x150	4540	188.00	1	081090024
1x12	M24x300	4540	270.00	1	081090025
1x18	M24x460	4540	311.00	1	081090026
* 1.1/4x12	M33x300	6900	438.00	1	081090031
* 1.1/4x18	M33x460	6900	491.00	1	081090032
* 1.1/4x24	M33x610	6900	681.00	1	081090033
* 1.1/2x12	M39x300	9710	635.00	1	081090034
* 1.1/2x18	M39x460	9710	727.00	1	081090038
* 1.1/2x24	M39x610	9710	870.00	1	081090039
* 1.3/4x18	M45x460	12700	1,059.00	1	081090036

formats de vente spéciaux pour libre service

ØxE	CHF		
"			
3/8x6	24.80	1	081099010
1/2x9	47.00	1	081099012

Robur

8110
Tendeur œillet et chape à haute résistance zingué à chaud

CE



UNI 11841:2022

- CARACTÉRISTIQUES TECHNIQUES**
- Coefficient de sécurité : 5
 - Traitement thermique cage : normalisation
 - Traitement thermique chapes : bonification
- Code lot de fabrication
- ANALYSES DE LABORATOIRE**
- analyse chimique
 - essai de traction
- CERTIFICATS DISPONIBLES**
- Spécification produit
 - Rapport d'essai type 2.2 UNI EN10204
 - Certificat de contrôle type 3.1 UNI EN10204
 - Déclaration de Conformité CE

ØxE	≈	WFL	CHF		
"	mm	kg			
1/2x6	M12x150	1000	33.50	5	081100006
1/2x9	M12x230	1000	41.50	5	081100010
5/8x6	M16x150	1590	58.00	2	081100014
5/8x9	M16x230	1590	68.00	2	081100015
5/8x12	M16x300	1590	79.50	2	081100016
3/4x6	M20x150	2360	86.00	2	081100019
3/4x9	M20x230	2360	99.00	2	081100020
3/4x12	M20x300	2360	113.00	2	081100021
7/8x12	M22x300	3270	165.00	1	081100022
1x6	M24x150	4540	169.00	1	081100027
1x12	M24x300	4540	242.50	1	081100029
*1.1/4x12	M33x300	6900	404.00	1	081100034
*1.1/4x18	M33x460	6900	480.00	1	081100035
*1.1/2x12	M39x300	9710	567.00	1	081100038
*1.1/2x18	M39x460	9710	642.00	1	081100039
*1.3/4x18	M45x460	12700	980.00	1	081100044

* Fourche avec axe traversant et goupille

8005Z
Tendeur à deux œillets, zingué

CE

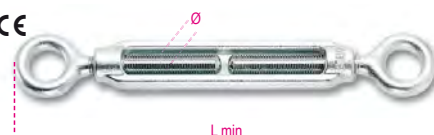

- CARACTÉRISTIQUES TECHNIQUES**
- coefficient de sécurité : 4
- ANALYSES DE LABORATOIRE**
- analyse chimique
 - essai de traction
- CERTIFICATS DISPONIBLES**
- Spécification produit
 - Rapport d'essai type 2.2 UNI EN10204
 - Déclaration de Conformité CE

Ø	≈	L min	WFL	CHF		
mm		mm	kg			
M5	3/16	118	115	2.94	400	080050105
M6	1/4	130	160	3.45	300	080050106
M8	5/16	158	300	5.20	200	080050108
M10	3/8	192	470	7.50	100	080050110
M11	7/16	206	580	10.00	80	080050111
M12	1/2	226	690	11.20	60	080050112
M14	9/16	256	940	15.80	15	080050114
M16	5/8	290	1290	23.20	10	080050116
M18	11/16	358	1660	35.50	1	080050118
M20	3/4	358	2130	40.50	1	080050120
M22	7/8	400	2630	52.50	1	080050122
M24	1"	436	3060	66.50	1	080050124
M27	1 1/8	474	4000	95.00	1	080050125
M30	1 3/16	498	4860	114.00	1	080050130
M33	1 1/4	516	6040	131.50	1	080050126
M36	1 3/8	532	6500	165.00	1	080050136
M39	1 1/2	544	7900	196.50	1	080050139

Filetage whitworth jusqu'à épauement des stocks
Nouveaux lots avec filetage métrique

Emballages spéciaux

Ø mm	≈	WFL mm	CHF	📦	🚚
M5	3/16	30	90.50	1	080050705
M6	1/4	30	101.50	1	080050706
M8	5/16	20	103.50	1	080050708
M10	3/8	15	110.50	1	080050710
M11	7/16	15	145.50	1	080050711
M12	1/2	15	170.00	1	080050712

formats de vente spéciaux pour libre service



Ø mm	≈	CHF	📦	🚚
M5	2	7.00	1	080059305
M6	2	8.00	1	080059306
M8	1	6.65	1	080059108
M10	1	8.75	1	080059110
M11	1	11.40	1	080059111
M12	1	12.70	1	080059112
M14	1	16.40	1	080059114
M16	1	24.40	1	080059116

8005TZ

Tendeur à deux œillets, cage en tube galvanisé



CARACTÉRISTIQUES TECHNIQUES

- coefficient de sécurité : 4
- ANALYSES DE LABORATOIRE
- analyse chimique
- essai de traction
- CERTIFICATS DISPONIBLES
- Spécification produit
- Rapport d'essai type 2.2 UNI EN10204
- Déclaration de Conformité CE

Ø mm	≈	WFL kg	CHF	📦	🚚
M12	1/2	690	15.30	15	080050512
M16	5/8	1290	26.00	1	080050516
M20	3/4	2130	41.00	1	080050520
M24	1"	3060	69.50	1	080050524
M27	1.1/8	4000	93.50	1	080050527
M30	1.3/16	4860	109.00	1	080050530
M36	1.3/8	6500	178.00	1	080050536

formats de vente spéciaux pour libre service



Ø mm	≈	CHF	📦	🚚
M12	1	17.90	1	080059512

8006Z

Tendeur œillet et crochet, zingué

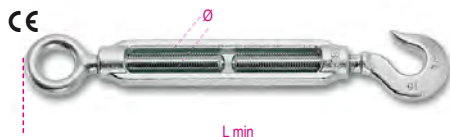

CARACTÉRISTIQUES TECHNIQUES

- coefficient de sécurité : 4
- ANALYSES DE LABORATOIRE
- analyse chimique
- essai de traction
- CERTIFICATS DISPONIBLES
- Spécification produit
- Rapport d'essai type 2.2 UNI EN10204
- Déclaration de Conformité CE

Ø mm	≈	L min mm	WFL kg	CHF	📦	🚚
M5	3/16	121	25	3.10	400	080060105
M6	1/4	132	45	3.45	250	080060106
M8	5/16	170	95	5.25	180	080060108
M10	3/8	204	140	7.70	100	080060110
M11	7/16	221	165	10.40	15	080060111
M12	1/2	244	300	12.00	15	080060112
M14	9/16	284	420	17.70	10	080060114
M16	5/8	322	570	26.50	1	080060116
M18	11/16	373	700	39.50	1	080060118
M20	3/4	391	900	46.50	1	080060120
M22	7/8	433	1100	60.50	1	080060122
M24	1"	470	1300	82.50	1	080060124
M27	1.1/8	503	2300	111.00	1	080060127

Emballages spéciaux

Ø mm	≈	CHF	📦	🚚	
M5	3/16	30	96.50	1	080060705
M6	1/4	30	106.50	1	080060706
M8	5/16	20	108.50	1	080060708
M10	3/8	15	120.00	1	080060710

formats de vente spéciaux pour libre service



Ø mm	≈	CHF	📦	🚚
M5	2	7.95	1	080069305
M6	2	8.85	1	080069306
M8	1	6.75	1	080069108
M10	1	9.25	1	080069110
M11	1	11.90	1	080069111
M12	1	13.40	1	080069112
M14	1	19.20	1	080069114

8007Z

Tendeur à deux crochets, zingué

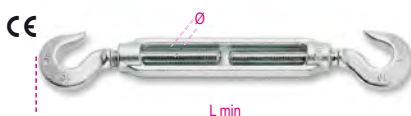

CARACTÉRISTIQUES TECHNIQUES

- coefficient de sécurité : 4
- ANALYSES DE LABORATOIRE
- analyse chimique
- essai de traction
- CERTIFICATS DISPONIBLES
- Spécification produit
- Rapport d'essai type 2.2 UNI EN10204
- Déclaration de Conformité CE

Ø mm	≈	L min mm	WFL kg	CHF	📦	🚚
M5	3/16	124	25	3.45	30	080070105
M6	1/4	134	45	3.80	30	080070106
M8	5/16	181	95	5.60	20	080070108
M10	3/8	211	140	8.20	15	080070110
M11	7/16	231	165	11.00	15	080070111
M12	1/2	262	300	13.20	15	080070112

Ø mm	≈	L min mm	WFL kg	CHF	📦	🚚
M14	9/16	312	420	20.10	1	080070114
M16	5/8	354	570	30.00	1	080070116
M18	11/16	388	700	42.00	1	080070118
M20	3/4	424	900	53.50	1	080070120
M22	7/8	466	1100	67.50	1	080070122
M24	1"	504	1300	95.00	1	080070124
M27	1.1/8	532	2300	123.50	1	080070127

formats de vente spéciaux pour libre service



Ø mm	≈	CHF	📦	🚚
M5	2	8.30	1	080079305
M6	2	8.85	1	080079306
M8	1	6.70	1	080079108
M10	1	9.05	1	080079110
M11	1	12.30	1	080079111
M12	1	14.50	1	080079112

8008N

Tendeur à deux tiges à souder, noir

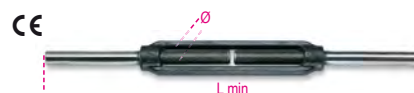

CARACTÉRISTIQUES TECHNIQUES

- coefficient de sécurité : 4
- ANALYSES DE LABORATOIRE
- analyse chimique
- essai de traction
- CERTIFICATS DISPONIBLES
- Spécification produit
- Rapport d'essai type 2.2 UNI EN10204
- Déclaration de Conformité CE

Ø mm	≈	L min mm	WFL kg	CHF	📦	🚚
M5	3/16	160	115	2.87	30	080080205
M6	1/4	180	160	2.94	30	080080206
M8	5/16	210	300	4.20	20	080080208
M10	3/8	250	470	6.00	15	080080210
M12	1/2	280	690	8.25	15	080080212
M14	9/16	340	940	11.90	5	080080214
M16	5/8	380	1290	16.40	5	080080216
M18	11/16	410	1660	24.80	3	080080218
M20	3/4	440	2130	29.00	3	080080220
M22	7/8	480	2630	39.50	2	080080222
M24	1"	520	3060	45.00	2	080080224
M27	1.1/8	560	4000	73.50	1	080080227
M30	1.3/16	560	4860	93.00	1	080080230
M33	1.1/4	600	6040	99.00	1	080080233
M36	1.3/8	600	6500	125.00	1	080080236
M39	1.1/2	600	7900	145.00	1	080080239

Filetage whitworth jusqu'à épauement des stocks
Nouveaux lots avec filetage métrique

formats de vente spéciaux pour libre service



Ø mm	≈	CHF	📦	🚚
M5	2	8.05	1	080089305
M6	2	8.20	1	080089306
M8	1	6.00	1	080089208
M10	1	7.95	1	080089210
M12	1	10.10	1	080089212
M14	1	14.00	1	080089214

Robur

8008TZN

Tendeur à deux tiges à souder,
cage en tube DIN 1478,
embouts noirs, corps galvanisé



CARACTÉRISTIQUES TECHNIQUES

- coefficient de sécurité: 4
- ANALYSES DE LABORATOIRE
- analyse chimique
- essai de traction
- CERTIFICATS DISPONIBLES
- Spécification produit
- Rapport d'essai type 2.2 UNI EN10204
- Déclaration de Conformité CE

Ø mm	≈ "	WFL kg	CHF	📦	📄
M12	1/2	690	11.20	10	080080512
M16	5/8	1290	20.10	1	080080516
M20	3/4	2130	30.00	1	080080520
M24	1	3060	49.50	1	080080524
M27	1.1/8	4000	76.00	1	080080527
M30	1.3/16	4860	87.50	1	080080530
M36	1.3/8	6500	142.50	1	080080536

8009Z

Tendeur à deux chapes, zingué

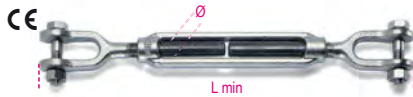

CARACTÉRISTIQUES TECHNIQUES

- coefficient de sécurité : 4
- ANALYSES DE LABORATOIRE
- analyse chimique
- essai de traction
- CERTIFICATS DISPONIBLES
- Spécification produit
- Rapport d'essai type 2.2 UNI EN10204
- Déclaration de Conformité CE

Ø mm	≈ "	L min mm	WFL kg	CHF	📦	📄
M8	5/16	192	300	16.90	15	080090008
M10	3/8	234	470	20.00	15	080090010
M12	1/2	274	690	28.50	15	080090012
M14	9/16	342	940	40.50	1	080090014
M16	5/8	372	1290	47.00	1	080090016
M18	11/16	406	1660	67.50	1	080090018
M20	3/4	406	2130	72.00	1	080090020
M22	7/8	466	2630	98.00	1	080090022
M24	1"	486	3060	110.50	1	080090024
M27	1 1/8	510	4000	171.00	1	080090027
M30	1 3/16	566	4860	219.00	1	080090030

formats de vente spéciaux pour libre
service

Ø mm	📦	CHF	📄
M8	1	18.60	1 080099008
M10	1	21.20	1 080099010
M12	1	28.50	1 080099012

8009TZ

Ridoir à deux chapes
DIN 1478
galvanisé



CARACTÉRISTIQUES TECHNIQUES

- coefficient de sécurité: 4
- ANALYSES DE LABORATOIRE
- analyse chimique
- essai de traction
- CERTIFICATS DISPONIBLES
- Spécification produit
- Rapport d'essai type 2.2 UNI EN10204
- Déclaration de Conformité CE

Ø mm	≈ "	WFL kg	CHF	📦	📄
M12	1/2	690	26.50	10	080090512
M16	5/8	1290	45.00	1	080090516
M20	3/4	2130	64.00	1	080090520
M24	1	3060	100.50	1	080090524
M27	1.1/8	4000	139.00	1	080090527
M30	1.3/16	4860	179.00	1	080090530

formats de vente spéciaux pour libre
service

Ø mm	📦	CHF	📄
M12	1	29.50	1 080099512

8010Z

Tendeur oeillet et chape, zingué



CARACTÉRISTIQUES TECHNIQUES

- coefficient de sécurité : 4
- ANALYSES DE LABORATOIRE
- analyse chimique
- essai de traction
- CERTIFICATS DISPONIBLES
- Spécification produit
- Rapport d'essai type 2.2 UNI EN10204
- Déclaration de Conformité CE

Ø mm	≈ "	L min mm	WFL kg	CHF	📦	📄
M8	5/16	175	300	10.10	20	080100008
M10	3/8	215	470	12.80	15	080100010
M12	1/2	250	690	19.10	10	080100012
M14	9/16	299	940	26.00	10	080100014
M16	5/8	331	1290	34.50	1	080100016
M18	11/16	382	1660	52.00	1	080100018
M20	3/4	382	2130	57.00	1	080100020
M22	7/8	433	2630	77.00	1	080100022
M24	1"	461	3060	90.00	1	080100024
M27	1 1/8	492	4000	133.50	1	080100027
M30	1 3/16	529	4860	171.00	1	080100030

formats de vente spéciaux pour libre
service

Ø mm	📦	CHF	📄
M8	1	12.00	1 080109008
M10	1	14.90	1 080109010
M12	1	20.20	1 080109012
M14	1	28.50	1 080109014

8010TZ

Tendeur œillet et chape
cage en tube DIN 1478,
zingué



CARACTÉRISTIQUES TECHNIQUES

- coefficient de sécurité: 4
- ANALYSES DE LABORATOIRE
- analyse chimique
- essai de traction
- CERTIFICATS DISPONIBLES
- Spécification Produit
- Rapport d'essai type 2.2 UNI EN10204
- Déclaration de Conformité CE

Ø mm	≈ "	WFL kg	CHF	📦	📄
M12	1/2	690	20.80	10	080100612
M16	5/8	1290	36.00	1	080100616
M20	3/4	2130	54.00	1	080100620
M24	1	3060	89.00	1	080100624
M27	1.1/8	4000	124.50	1	080100627
M30	1.3/16	4860	150.50	1	080100630

8001Z

Cage pour tendeurs, zingué



CARACTÉRISTIQUES TECHNIQUES

- coefficient de sécurité : 5
- code lot de fabrication
- ANALYSES DE LABORATOIRE
- analyse chimique
- essai de traction
- CERTIFICATS DISPONIBLES
- Spécification produit
- Rapport d'essai type 2.2 UNI EN10204
- Déclaration de Conformité CE

Ø mm	≈ "	L mm	WFL kg	CHF	📦	📄
M5	3/16	80	115	1.79	100	080010105
M6	1/4	80	160	1.88	100	080010106
M8	5/16	105	300	2.94	25	080010108
M10	3/8	125	470	3.80	20	080010110
M11	7/16	135	580	4.65	15	080010111
M12	1/2	140	690	5.05	20	080010112
M14	9/16	170	940	7.05	15	080010114
M16	5/8	190	1290	9.60	15	080010116
M18	11/16	205	1660	15.30	10	080010118
M20	3/4	220	2130	17.60	10	080010120
M22	7/8	240	2630	22.30	8	080010122
M24	1"	260	3060	27.00	5	080010124
M27	1 1/8	270	4000	42.50	1	080010127
M30	1 3/16	280	4860	54.00	1	080010130
M33	1 1/4	290	6040	59.50	1	080010133
M36	1 3/8	300	6500	76.00	1	080010136
M39	1 1/2	300	7900	91.00	1	080010139

Filetage whitworth jusqu'à épauement des stocks
Nouveaux lots avec filetage métrique

formats de vente spéciaux pour libre
service

Ø mm	📦	CHF	📄
M5	2	5.40	1 080019305
M6	2	5.90	1 080019306
M8	1	4.65	1 080019108
M10	1	5.45	1 080019110
M11	1	6.60	1 080019111
M12	1	6.80	1 080019112
M14	1	9.05	1 080019114
M16	1	11.50	1 080019116
M18	1	17.10	1 080019118
M20	1	19.20	1 080019120
M22	1	24.30	1 080019122
M24	1	29.00	1 080019124

Robur

8001TZ

Cage en tube pour tendeurs, galvanisé

CE



DIN 1478

CARACTÉRISTIQUES TECHNIQUES

- coefficient de sécurité : 5
 - code lot de fabrication
- ### ANALYSES DE LABORATOIRE
- analyse chimique
 - essai de traction
- ### CERTIFICATS DISPONIBLES
- Spécification produit
 - Rapport d'essai type 2.2 UNI EN10204
 - Déclaration de Conformité CE

Ø mm	≈ "	L mm	WFL kg	CHF	📦	🚚
M12	1/2	125	690	8.30	10	080010512
M16	5/8	170	1290	12.70	5	080010516
M20	3/4	200	2130	16.70	5	080010520
M24	1	255	3060	29.50	3	080010524
*M27	1 1/8	255	4000	39.50	1	080010527
M30	1 3/16	255	4860	44.50	1	080010530
M36	1 3/8	295	6500	80.50	1	080010536
M42	1 5/8	330	9700	113.50	1	080010542

*Tailles non prévues par la norme

formats de vente spéciaux pour libre service



Ø mm	📦	CHF	📦	🚚
M12	1	10.00	1	080019512
M16	1	14.00	1	080019516
M20	1	18.20	1	080019520
M24	1	30.50	1	080019524

8002ZD

Œillet pour tendeurs filetage à droite zingué

Sur demande, avec filetage à gauche



CARACTÉRISTIQUES TECHNIQUES

- coefficient de sécurité : 4
- ### ANALYSES DE LABORATOIRE
- analyse chimique
 - essai de traction
- ### CERTIFICATS DISPONIBLES
- Spécification produit
 - Rapport d'essai type 2.2 UNI EN10204

Ø mm	≈ "	E mm	WFL kg	CHF	📦	🚚
M5	3/16	37	115	0.62	200	080020105
M6	1/4	40	160	0.76	150	080020106
M8	5/16	52	300	1.12	100	080020108
M10	3/8	60	470	1.79	100	080020110
M11	7/16	65	580	2.53	1	080020111
M12	1/2	72	690	3.15	50	080020112
M14	9/16	85	940	3.90	1	080020114
M16	5/8	95	1290	6.60	1	080020116
M18	11/16	103	1660	9.60	1	080020118
M20	3/4	110	2130	10.80	1	080020120
M22	7/8	120	2630	15.80	1	080020122
M24	1"	130	3060	20.00	1	080020124
M27	1 1/8	135	4000	27.50	1	080020127
M30	1 3/16	140	4860	32.00	1	080020130
M33	1 1/4	148	6040	39.00	1	080020133
M36	1 3/8	150	6500	47.00	1	080020136
M39	1 1/2	150	7900	55.00	1	080020139

Filetage whitworth jusqu'à épauement des stocks
Nouveaux lots avec filetage métrique

8004ND

Tige pour tendeurs filetage à droite - noir

Sur demande avec filetage à gauche



CARACTÉRISTIQUES TECHNIQUES

- coefficient de sécurité : 4
- ### ANALYSES DE LABORATOIRE
- analyse chimique
 - essai de traction
- ### CERTIFICATS DISPONIBLES
- Spécification produit
 - Rapport d'essai type 2.2 UNI EN10204

Ø mm	≈ "	E mm	WFL kg	CHF	📦	🚚
M5	3/16	40	115	0.65	1	080040005
M6	1/4	44	160	0.76	1	080040006
M8	5/16	53	300	0.90	1	080040008
M10	3/8	63	470	1.32	1	080040010
M12	1/2	70	690	2.20	1	080040012
M14	9/16	85	940	3.00	1	080040014
M16	5/8	95	1290	4.15	1	080040016
M18	11/16	103	1660	5.65	1	080040018
M20	3/4	110	2130	7.05	1	080040020
M22	7/8	120	2630	8.75	1	080040022
M24	1"	130	3060	12.40	1	080040024
M27	1 1/8	135	4000	19.80	1	080040027
M30	1 3/16	140	4860	24.60	1	080040030
M33	1 1/4	150	6040	25.50	1	080040033
M36	1 3/8	150	6500	33.50	1	080040036
M39	1 1/2	150	7900	36.00	1	080040039

Filetage whitworth jusqu'à épauement des stocks
Nouveaux lots avec filetage métrique

Ø mm	≈ "	E mm	WFL kg	CHF	📦	🚚
M5	3/16	40	115	0.65	1	080040105
M6	1/4	44	160	0.76	1	080040106
M8	5/16	53	300	0.90	1	080040108
M10	3/8	63	470	1.32	1	080040110
M12	1/2	70	690	2.20	1	080040112
M14	9/16	85	940	3.00	1	080040114
M16	5/8	95	1290	4.15	1	080040116
M18	11/16	103	1660	5.65	1	080040118
M20	3/4	110	2130	7.05	1	080040120
M22	7/8	120	2630	8.75	1	080040122
M24	1"	130	3060	12.40	1	080040124
M27	1 1/8	135	4000	19.80	1	080040127
M30	1 3/16	140	4860	24.60	1	080040130
M33	1 1/4	150	6040	25.50	1	080040133
M36	1 3/8	150	6500	33.50	1	080040136
M39	1 1/2	150	7900	36.00	1	080040139



Ø mm	≈ "	E mm	WFL kg	CHF	📦	🚚
M5	3/16	37	115	0.62	1	080020305
M6	1/4	40	160	0.76	1	080020306
M8	5/16	52	300	1.12	1	080020308
M10	3/8	60	470	1.79	1	080020310
M11	7/16	65	580	2.53	1	080020311
M12	1/2	72	690	3.15	1	080020312
M14	9/16	85	940	3.90	1	080020314
M16	5/8	95	1290	6.60	1	080020316
M18	11/16	103	1660	9.60	1	080020318
M20	3/4	110	2130	10.80	1	080020320
M22	7/8	120	2630	15.80	1	080020322
M24	1"	130	3060	20.00	1	080020324
M27	1 1/8	135	4000	27.50	1	080020327
M30	1 3/16	140	4860	32.00	1	080020330
M33	1 1/4	148	6040	39.00	1	080020333
M36	1 3/8	150	6500	47.00	1	080020336
M39	1 1/2	150	7900	55.00	1	080020339

8003ZD

Crochet pour tendeurs filetage à droite zingué

Sur demande, avec filetage à gauche

CE



CARACTÉRISTIQUES TECHNIQUES

- coefficient de sécurité : 4
- ### ANALYSES DE LABORATOIRE
- analyse chimique
 - essai de traction
- ### CERTIFICATS DISPONIBLES
- Spécification produit
 - Rapport d'essai type 2.2 UNI EN10204

Ø mm	≈ "	E mm	WFL kg	CHF	📦	🚚
M5	3/16	40	25	0.82	150	080030105
M6	1/4	40	45	0.93	120	080030106
M8	5/16	52	95	1.38	100	080030108
M10	3/8	60	140	2.46	70	080030110
M11	7/16	65	165	3.35	1	080030111
M12	1/2	70	300	4.30	30	080030112
M14	9/16	85	420	6.60	1	080030114
M16	5/8	95	570	9.80	1	080030116
M18	11/16	103	700	13.20	1	080030118
M20	3/4	110	900	17.90	1	080030120
M22	7/8	120	1100	23.20	1	080030122
M24	1"	130	1300	35.50	1	080030124
M27	1 1/8	135	2300	42.00	1	080030127

Ø mm	≈ "	WFL kg	E mm	CHF	📦	🚚
M5	3/16	40	25	0.82	1	080030305
M6	1/4	40	45	0.93	1	080030306
M8	5/16	52	95	1.38	1	080030308
M10	3/8	60	140	2.46	1	080030310
M11	7/16	65	165	3.35	1	080030311
M12	1/2	70	300	4.30	1	080030312
M14	9/16	85	420	6.60	1	080030314
M16	5/8	95	570	9.80	1	080030316
M18	11/16	103	700	13.20	1	080030318
M20	3/4	110	900	17.90	1	080030320
M22	7/8	120	1100	23.20	1	080030322
M24	1"	130	1300	35.50	1	080030324
M27	1 1/8	135	2300	42.00	1	080030327

8009FD

Chape pour tendeurs
filetage à droite - galvanisée



CARACTÉRISTIQUES TECHNIQUES

• coefficient de sécurité : 4

ANALYSES DE LABORATOIRE

• analyse chimique
• essai de traction

CERTIFICATS DISPONIBLES

• Spécification produit
• Rapport d'essai type 2.2 UNI EN10204

Ø mm	≈ "	E mm	WFL kg	CHF		
M8	5/16	53	300	6.95	1	080090208
M10	3/8	63	470	8.20	1	080090210
M12	1/2	70	690	11.00	1	080090212
M14	9/16	85	940	15.30	1	080090214
M16	5/8	95	1290	17.40	1	080090216
M18	11/16	103	1660	24.60	1	080090218
M20	3/4	110	2130	25.50	1	080090220
M22	7/8	120	2630	36.00	1	080090222
M24	1"	130	3060	41.50	1	080090224
M27	1 1/8	135	4000	65.00	1	080090227
M30	1 3/16	140	4860	84.50	1	080090230

chape pour tendeur à droite - zinguée

Ø mm	≈ "	WFL kg	G mm	CHF		
M8	5/16	53	300	6.95	1	080090408
M10	3/8	63	470	8.20	1	080090410
M12	1/2	70	690	11.00	1	080090412
M14	9/16	85	940	15.30	1	080090414
M16	5/8	95	1290	17.40	1	080090416
M18	11/16	103	1660	24.60	1	080090418
M20	3/4	110	2130	25.50	1	080090420
M22	7/8	120	2630	36.00	1	080090422
M24	1"	130	3060	41.50	1	080090424
M27	1 1/8	135	4000	65.00	1	080090427
M30	1 3/16	140	4860	84.50	1	080090430

8048

Chape mâle filetage à droite, noire



UNI 6058

ØxL mm	WFL kg	F mm	CHF		
M8x50	430	6	4.35	20	080480108
M8x65	430	6	4.65	20	080480109
M10x80	690	8	7.25	10	080480110
M10x100	690	8	7.25	10	080480210
M10x130	690	8	8.20	10	080480111
M12x70	1020	10	7.50	8	080480212
M12x95	1020	10	7.70	8	080480112
M12x125	1020	10	9.45	8	080480113
M14x110	1420	12	10.60	6	080480114
M16x100	1980	14	8.75	6	080480115
M16x130	1980	14	9.05	6	080480116
M18x150	2390	16	20.50	2	080480118
M20x160	3100	18	25.50	2	080480120
M22x180	3890	18	39.50	1	080480122
M24x200	4460	20	45.00	1	080480124
M24x220	4460	20	48.50	1	080480125
M27x220	5900	22	59.00	1	080480127

8302Z

Vis à œil pour chevilles filetage à droite
zinguée



CARACTÉRISTIQUES TECHNIQUES

• coefficient de sécurité : 4

CERTIFICATS DISPONIBLES

• Spécification produit
• Rapport d'essai type 2.2 UNI EN10204

Ø mm	E mm	F mm	WFL kg	CHF		
M5	48	8	115	0.70	200	083020005
M6	55	10	160	0.85	150	083020006
M8	60	12	300	1.15	100	083020008
M10	73	14	470	1.95	100	083020010
M12	90	17	690	3.80	50	083020012

8303Z

Crochet pour chevilles filetage à droite
zingué



CARACTÉRISTIQUES TECHNIQUES

• coefficient de sécurité : 4

CERTIFICATS DISPONIBLES

• Spécification produit
• Rapport d'essai type 2.2 UNI EN10204

Ø mm	C mm	E mm	WFL kg	CHF		
M5	6,0	48	25	0.82	120	083030005
M6	8,0	55	45	0.90	100	083030006
M8	10,0	60	95	1.46	75	083030008
M10	12,5	73	140	2.46	50	083030010
M12	16,0	90	220	4.10	20	083030012

8702N - 8702Z - 8702ZC

Cosse à presser en acier forgé,
embout à sertir à œil
noir



CARACTÉRISTIQUES TECHNIQUES

• Code lot de fabrication

ANALYSES DE LABORATOIRE

• Analyse chimique
• Essai de traction

CERTIFICATS DISPONIBLES

• Spécification produit
• Rapport d'essai type 2.2 UNI EN10204
• Certificat de contrôle type 3.1 UNI EN10204

M	ØB mm	ØA mm	ØD mm	CHF		
6	6,8	13	19	59.00	1	087020106
8	8,8	20	22	70.50	1	087020108
9	9,8	20	22	70.50	1	087020109
10	10,8	20	22	70.50	1	087020110
11	11,8	25	27	87.50	1	087020111
12	12,8	25	27	87.50	1	087020112
13	13,8	25	27	87.50	1	087020113
14	14,8	32	32	121.50	1	087020114
15	15,9	32	32	121.50	1	087020115
16	17,0	32	32	121.50	1	087020116
18	19,0	39	37	157.50	1	087020118
19	20,0	39	37	157.50	1	087020119
20	21,1	39	37	157.50	1	087020120
22	23,2	43	43	219.00	1	087020122
24	25,4	50	52	252.00	1	087020124
25	26,4	50	52	252.00	1	087020125
26	27,4	50	52	252.00	1	087020126

Le pressage de la cosse nécessite de presses et de moules spéciaux et peut être effectué exclusivement par un personnel spécialisé.

8702Z galvanisé

M	ØB mm	ØA mm	ØD mm	CHF		
6	6,8	13	19	61.50	1	087020306
8	8,8	20	22	74.50	1	087020308
9	9,8	20	22	74.50	1	087020309
10	10,8	20	22	74.50	1	087020310
11	11,8	25	27	91.00	1	087020311
12	12,8	25	27	91.00	1	087020312
13	13,8	25	27	91.00	1	087020313
14	14,8	32	32	127.50	1	087020314
15	15,9	32	32	127.50	1	087020315
16	17,0	32	32	127.50	1	087020316
18	19,0	39	37	165.00	1	087020318
19	20,0	39	37	165.00	1	087020319
20	21,1	39	37	165.00	1	087020320
22	23,2	43	43	226.50	1	087020322
24	25,4	50	52	263.00	1	087020324
25	26,4	50	52	263.00	1	087020325
26	27,4	50	52	263.00	1	087020326

8702ZC galvanisé à chaud

M	ØB mm	ØA mm	ØD mm	CHF		
6	6,8	13	19	65.00	1	087020206
8	8,8	20	22	80.50	1	087020208
9	9,8	20	22	80.50	1	087020209
10	10,8	20	22	80.50	1	087020210
11	11,8	25	27	100.00	1	087020211
12	12,8	25	27	100.00	1	087020212
13	13,8	25	27	100.00	1	087020213
14	14,8	32	32	147.50	1	087020214
15	15,9	32	32	147.50	1	087020215
16	17,0	32	32	147.50	1	087020216
18	19,0	39	37	190.50	1	087020218
19	20,0	39	37	190.50	1	087020219
20	21,1	39	37	190.50	1	087020220
22	23,2	43	43	259.00	1	087020222
24	25,4	50	52	302.00	1	087020224
25	26,4	50	52	302.00	1	087020225
26	27,4	50	52	302.00	1	087020226

Robur

8709N - 8709Z - 8709ZC

Cossé à presser en acier forgé embout à sertir à chape noir



CARACTÉRISTIQUES TECHNIQUES

- Code lot de fabrication
- ANALYSES DE LABORATOIRE**
- Analyse chimique
- Essai de traction
- CERTIFICATS DISPONIBLES**
- Spécification produit
- Rapport d'essai type 2.2 UNI EN10204
- Certificat de contrôle type 3.1 UNI EN10204

M	Ø B mm	Ø A mm	Ø C mm	CHF		
6	6,8	13	17	80.50	1	087090106
8	8,8	20	21	104.00	1	087090108
9	9,8	20	21	104.00	1	087090109
10	10,8	20	21	104.00	1	087090110
11	11,8	25	25	130.00	1	087090111
12	12,8	25	25	130.00	1	087090112
13	13,8	25	25	130.00	1	087090113
14	14,8	32	30	181.50	1	087090114
15	15,9	32	30	181.50	1	087090115
16	17,0	32	30	181.50	1	087090116
18	19,0	39	35	235.50	1	087090118
19	20,0	39	35	235.50	1	087090119
20	21,1	39	35	235.50	1	087090120
22	23,2	43	41	301.00	1	087090122
24	25,4	50	51	309.00	1	087090124
25	26,4	50	51	309.00	1	087090125
26	27,4	50	51	309.00	1	087090126

Le pressage de la cosse nécessite de presses et de moules spéciaux et peut être effectué exclusivement par un personnel spécialisé.

8709Z galvanisé

M	Ø B mm	Ø A mm	Ø C mm	CHF		
6	6,8	13	17	83.00	1	087090306
8	8,8	20	21	109.00	1	087090308
9	9,8	20	21	109.00	1	087090309
10	10,8	20	21	109.00	1	087090310
11	11,8	25	25	135.50	1	087090311
12	12,8	25	25	135.50	1	087090312
13	13,8	25	25	135.50	1	087090313
14	14,8	32	30	190.50	1	087090314
15	15,9	32	30	190.50	1	087090315
16	17,0	32	30	190.50	1	087090316
18	19,0	39	35	246.50	1	087090318
19	20,0	39	35	246.50	1	087090319
20	21,0	39	35	246.50	1	087090320
22	23,2	43	41	324.00	1	087090322
24	25,4	50	51	324.00	1	087090324
25	26,4	50	51	324.00	1	087090325
26	27,4	50	51	324.00	1	087090326

8709ZC galvanisé à chaud

M	Ø B mm	Ø A mm	Ø C mm	CHF		
6	6,8	13	17	86.00	1	087090206
8	8,8	20	21	114.50	1	087090208
9	9,8	20	21	114.50	1	087090209
10	10,8	20	21	114.50	1	087090210
11	11,8	25	25	148.00	1	087090211
12	12,8	25	25	148.00	1	087090212
13	13,8	25	25	148.00	1	087090213
14	14,8	32	30	215.00	1	087090214
15	15,9	32	30	215.00	1	087090215
16	17,0	32	30	215.00	1	087090216
18	19,0	39	35	274.00	1	087090218
19	20,0	39	35	274.00	1	087090219
20	21,1	39	35	274.00	1	087090220
22	23,2	43	41	350.00	1	087090222
24	25,4	50	51	384.00	1	087090224
25	26,4	50	51	384.00	1	087090225
26	27,4	50	51	384.00	1	087090226

8015

Pince pour câble, type Américain, corps en acier, galvanisé à chaud

CE

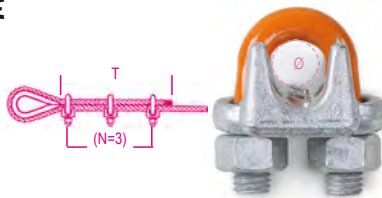

dimensioni EN 13411-5 tipo B

DONNÉES TECHNIQUES

- code de traçabilité TESTS DE LABORATOIRE
- analyse chimique
- essai de couple CERTIFICATS DISPONIBLES
- Spécifications techniques du produit
- Rapport d'essai UNI EN10204 type 2.2
- Certificat de fabricant UNI EN13411-5
- Déclaration de conformité CE

Ø mm	Ø "	NxT	Nm	CHF		
8	5/16	3x133	40,7	2.94	12	080150808
10	3/8	3x165	61	4.10	12	080150810
13	1/2	3x292	88	6.35	6	080150813
16	5/8	3x305	129	8.95	6	080150816
20	3/4	4x460	176	12.30	6	080150820
22	7/8	4x480	305	19.50	6	080150822
26	1	5x660	305	21.20	5	080150826
30	1-1/8	6x860	305	22.70	2	080150830

8016

Serre-câble en acier, estampé à chaud zingué

CE

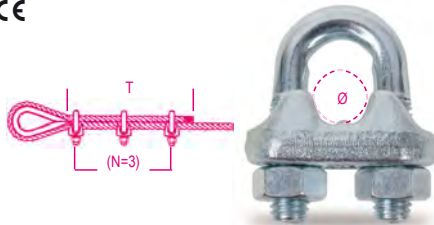

ANALYSES DE LABORATOIRE

- analyse chimique
- essai de couple de serrage CERTIFICATS DISPONIBLES
- Spécification produit
- Rapport d'essai type 2.2 UNI EN10204
- Certificat de Conformité CE

Ø mm	Ø "	N x T	Nm	CHF		
3	1/8	3x80	1,53	0.80	500	080160003
5	3/16	3x110	3,02	1.01	300	080160005
6	1/4	3x120	5,19	1.12	200	080160006
8	5/16	5x210	5,19	1.38	150	080160008
10	3/8	5x240	12,54	2.08	70	080160010
11	7/16	5x260	12,54	2.24	70	080160011
12-13	1/2	5x300	24,76	2.99	40	080160013
14	9/16	5x295	24,76	3.25	35	080160014
16	5/8	5x335	24,76	3.85	30	080160016
18	11/16	5x380	42,42	5.20	30	080160018
20	3/4	5x540	42,42	5.65	30	080160020
22	7/8	7x595	42,42	6.60	25	080160022
24-26	1"	7x700	67,56	9.05	15	080160026
28	1 1/16	8x840	67,56	11.30	5	080160028
30-32	1 1/8	8x990	67,56	11.40	5	080160030
34-36	1 1/4	8x1155	105,80	15.00	4	080160034
38-40	1 1/2	8x1320	105,80	20.20	2	080160040
45-50	2"	8x1500	206	31.00	1	080160050

Emballages spéciaux

Ø mm	"		CHF		
3	1/8	100	79.50	1	080160703
5	3/16	50	50.00	1	080160705
6	1/4	50	56.00	1	080160706
8	5/16	30	41.50	1	080160708
10	3/8	30	62.00	1	080160710
11	7/16	25	56.00	1	080160711
12-13	1/2	15	44.50	1	080160713

formats de vente spéciaux pour libre service

Ø mm	"	CHF		
3	6	5.95	1	080169403
5	4	5.25	1	080169405
6	4	5.90	1	080169406
8	4	6.80	1	080169408
10	2	5.45	1	080169410
11	1	3.95	1	080169011
12-13	1	4.65	1	080169013
14	1	4.90	1	080169014
16	1	5.45	1	080169016
18	1	6.95	1	080169018
20	1	7.05	1	080169020
22	1	8.30	1	080169022
24-26	1	10.90	1	080169026

8016FR

Serre-câble en acier avec corps moulé à froid galvanisés

CE

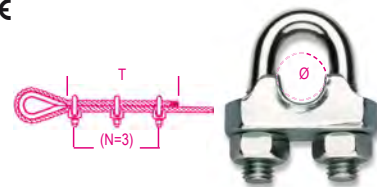

ANALYSES DE LABORATOIRE

- analyse chimique
- CERTIFICATS DISPONIBLES**
- Spécification produit
- Rapport d'essai type 2.2 UNI EN10204
- Certificat de Conformité CE

Ø mm	Ø "	N x T	Nm	CHF		
3	1/8	3x80	1,25	0.74	500	080160253
5	3/16	3x110	2,46	0.87	300	080160255
6	1/4	3x120	4,24	1.06	200	080160256
8	5/16	5x210	4,24	1.23	150	080160258

formats de vente spéciaux pour libre service

Ø mm	"	CHF		
3	6	6.35	1	080169753
5	6	5.60	1	080169755
6	4	6.20	1	080169756
8	4	6.65	1	080169758

Robur

8018E

Serre-câble, type ENEL, galvanisé à chaud



ANALYSES DE LABORATOIRE

- analyse chimique
- CERTIFICATS DISPONIBLES
- Spécification produit
- Rapport d'essai type 2.2 UNI EN10204

Ø mm	A mm	L mm	Nm	CHF		
4+6	M6	34	4,24	1.60	100	080180001

8016U2

Serre-câbles, type Acorp en fonte, zingué

CE

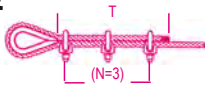

dimensioni EN 13411-5 tipo A

CARACTÉRISTIQUES TECHNIQUES

code d'identification ANALYSES DE LABORATOIRE • analyse chimique • essai de couple de serrage CERTIFICATS DISPONIBLES • Spécification produit • Rapport d'essai type 2.2 UNI EN10204 • Certificat du Fabricant UNI EN13411-5 • Certificat de Conformité CE

Ø mm	Ø "	N x T	Nm	CHF		
5	3/16	3x156	2,0	0.44	300	080160855
6,5	1/4	3x192	3,5	0.59	150	080160856
8	5/16	4x320	6	1.20	70	080160858
10	3/8	4x320	9	1.24	60	080160860
12	1/2	4x384	20	2.36	25	080160862
14	9/16	4x448	33	3.70	15	080160864
16	5/8	4x512	49	5.45	10	080160866
19	3/4	4x512	68	6.35	10	080160869
22	7/8	5x680	107	9.05	10	080160872
26	1	5x760	147	16.40	5	080160876
30	1.1/8	6x984	212	21.00	5	080160880
34	1.1/4	6x1080	296	28.50	5	080160884
40	1.1/2	6x1176	363	35.50	5	080160890

formats de vente spéciaux pour libre service

Ø mm		CHF		
5	4	5.20	1	080169805
6	4	6.60	1	080169806
8	4	10.10	1	080169808
10	2	6.80	1	080169810
12	1	6.60	1	080169612
14	1	7.50	1	080169614
16	1	10.10	1	080169616
19	1	11.00	1	080169619
22	1	14.40	1	080169622
26	1	23.60	1	080169626

8016UGK

Serre-câble, type Acorp en fonte, corps GALVANISÉ À CHAUD étrier et écrous GEOMET-GEOKOTE

CE

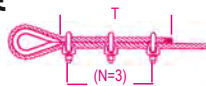

- Haute résistance à la corrosion
- Code d'identification

dimensioni EN 13411-5 tipo A

CARACTÉRISTIQUES TECHNIQUES

- Code d'identification
- ANALYSES DE LABORATOIRE
- Analyse chimique
- Essai de couple de serrage
- CERTIFICATS DISPONIBLES
- Spécification produit
- Rapport d'essai type 2.2 UNI EN10204
- Certificat du Fabricant UNI EN13411-5
- Déclaration de Conformité CE

Ø mm	Ø "	N x T	Nm	CHF		
8	5/16	4x320	6	2.36	70	080160758
10	3/8	4x320	9	2.61	60	080160760
12	1/2	4x448	33	4.65	25	080160762
14	9/16	4x384	20	6.80	15	080160764
16	5/8	4x512	49	10.10	10	080160766
19	3/4	4x512	68	11.40	10	080160769
22	7/8	5x680	107	16.40	10	080160772
26	1	5x760	147	26.50	5	080160776
30	1.1/8	6x984	212	32.00	1	080160780
34	1.1/4	6x1080	296	46.00	1	080160784
40	1.1/2	6x1176	363	57.00	1	080160790

8018T

Serre-câble, type TELECOM, corp en fonte zingué



RUM-MU-21:1980

ANALYSES DE LABORATOIRE

- analyse chimique
- CERTIFICATS DISPONIBLES
- Spécification produit
- Rapport d'essai type 2.2 UNI EN10204

Ø mm	A mm	L mm	Nm	CHF		
8÷10	M8	42	10,20	1.64	200	080180003

8020A

Cosse cœur type léger, zinguée

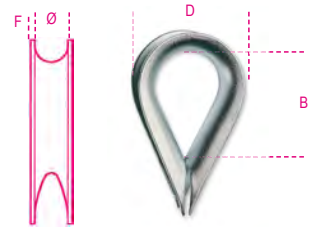

CERTIFICATS DISPONIBLES

- Spécification produit
- Rapport d'essai type 2.2 UNI EN10204

Ø mm	F mm	B mm	D mm	CHF		
2-3	1,0	20	18	0.30	150	080200503
4	1,2	23	19	0.31	150	080200504
5	1,2	24	23	0.36	100	080200505
6	1,2	27	28	0.38	100	080200506
8	1,4	33	32	0.59	50	080200508
10	1,8	41	38	0.86	30	080200510
12	2,2	44	45	1.13	30	080200512
14	2,2	52	49	1.46	50	080200514
16	3,0	58	58	2.04	50	080200516
18	3,7	64	68	2.87	50	080200518
20	3,7	73	74	3.70	35	080200520
22	3,7	83	79	4.15	30	080200522
24	3,7	93	88	5.45	20	080200525

Emballages spéciaux

Ø mm	S mm		CHF		
2-3	0,8	150	39.00	1	080200703
4	1,0	150	41.00	1	080200704
5	1,0	100	31.00	1	080200705
6	1,0	100	29.50	1	080200706
8	1,2	50	26.00	1	080200708
10	1,5	30	22.70	1	080200710

8021A

Cosse-cœur type lourd, zingué

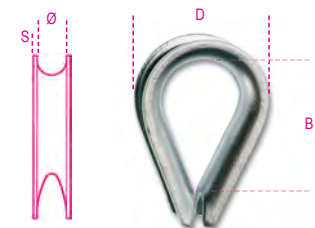

CERTIFICATS DISPONIBLES

- Spécification produit
- Rapport d'essai type 2.2 UNI EN10204

Ø mm	S mm	B mm	D mm	CHF		
2-3	0,6	15	16	0.49	150	080210103
5	1,7	29	28	0.70	120	080210105
6	1,8	33	30	0.77	100	080210106
8	2,5	36	37	1.05	100	080210108
10	2,5	42	43	1.27	80	080210110
12	2,5	48	50	1.64	100	080210112
14	2,7	58	57	2.20	70	080210114
16	3	61	62	2.68	50	080210116
18	3,5	71	71	3.50	70	080210118
20	4	79	79	5.20	30	080210120
22	4	87	84	6.00	25	080210122
24	4	93	92	7.05	25	080210124
26	4	103	103	8.75	20	080210126
28	5	107	116	20.50	1	080210128
30	5	118	121	20.50	1	080210130
32	5,5	138	135	24.60	1	080210132
35	6	140	147	34.00	1	080210135
40	6,0	174	170	48.50	1	080210140



8026R

Manille droite haute résistance,
axe à œil, an acier allié,
bride galvanisée à chaud

CE

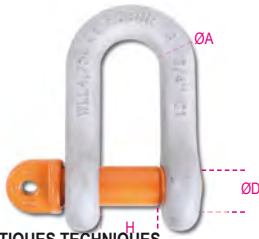

EN 13889
GRADE 6

CARACTÉRISTIQUES TECHNIQUES

- coefficient de sécurité minimum: 6
- traitement thermique: bonification
- code lot de fabrication sur pivot et bride
- ANALYSES DE LABORATOIRE
- analyse chimique • analyse métallographique
- essai de traction • essai de fatigue (min. 20.000 cycles)
- test charge d'essai (WLL x 2)
- CERTIFICATS DISPONIBLES
- Spécification produit • Rapport d'essai type 2.2 UNI EN10204
- Certificat de contrôle type 3.1 UNI EN10204
- Déclaration de Conformité CE

ØD mm	ØA mm	H mm	WLL kg	CHF		
11	10	17	1000	7.95	5	080260210
16	13	21	2000	14.80	5	080260212
19	16	27	3250	24.90	3	080260216
22	19	32	4750	36.00	2	080260219
25	22	37	6500	55.00	2	080260222

formats de vente spéciaux pour libre
service

ØD mm	CHF		
16	16.10	1	080269212
19	26.50	1	080269216

8029R

Manille lyre haute résistance
en acier allié,
axe carré femelle,
bride galvanisée à chaud



EN 13889
GRADO 6

CARACTÉRISTIQUES TECHNIQUES

- coefficient de sécurité minimum : 6
- traitement thermique : bonification
- code lot de fabrication sur pivot et bride
- ANALYSES DE LABORATOIRE
- analyse chimique
- analyse métallographique
- essai de traction
- essai de fatigue (min. 20.000 cycles)
- test charge d'essai (WLL x 2)
- CERTIFICATS DISPONIBLES
- Spécification produit
- Rapport d'essai type 2.2 UNI EN10204
- Certificat de contrôle type 3.1 UNI EN10204
- Déclaration de Conformité CE

ØD mm	ØA mm	H mm	WLL kg	CHF		
8	6	13	500	4.85	20	080290106
10	8	13,5	750	5.90	15	080290108
11	10	17	1000	8.30	15	080290110
13	11	18,5	1500	11.00	10	080290111
16	13	20,5	2000	11.40	8	080290112
19	16	27	3250	19.50	8	080290116
22	19	32	4750	28.50	4	080290120
25	22	37	6500	42.50	4	080290122
28	26	43,5	8500	59.00	1	080290124

ØD mm	ØA mm	H mm	WLL kg	CHF		
32	29	48	9500	109.50	1	080290128
35	32	53	12000	147.00	1	080290132
38	35	59	13500	193.00	1	080290135
42	38	62	17000	252.00	1	080290138
50	45	75	25000	432.00	1	080290145
57	50	83	35000	755.00	1	080290150
65	57	95	42500	1,300.00	1	080290157
70	65	105	55000	1,490.00	1	080290165

formats de vente spéciaux pour libre
service

ØD mm	CHF		
8	6.60	1	080299106
10	7.50	1	080299108
11	10.10	1	080299110
13	12.80	1	080299111
16	13.00	1	080299112
19	22.00	1	080299116

8031R

Manille lyre haute résistance
en acier allié,
axe avec écrou à goupille,
bride galvanisée à chaud



EN 13889
GRADO 6

CARACTÉRISTIQUES TECHNIQUES

- coefficient de sécurité minimum : 6
- traitement thermique : bonification
- code lot de fabrication sur pivot et bride
- ANALYSES DE LABORATOIRE
- analyse chimique
- analyse métallographique
- essai de traction
- essai de fatigue (min. 20.000 cycles)
- test charge d'essai (WLL x 2)
- CERTIFICATS DISPONIBLES
- Spécification produit
- Rapport d'essai type 2.2 UNI EN10204
- Certificat de contrôle type 3.1 UNI EN10204
- Déclaration de Conformité CE

ØD mm	ØA mm	H mm	WLL kg	CHF		
11	10	17	1000	8.95	5	080310110
13	11	18	1500	13.80	5	080310111
16	13	21	2000	14.00	5	080310112
19	16	27	3250	24.10	3	080310116
22	19	32	4750	34.00	2	080310120
25	22	37	6500	47.00	2	080310122
28	26	43	8500	70.00	1	080310124
32	29	48	9500	120.00	1	080310128
35	32	53	12000	155.50	1	080310132
38	35	59	13500	219.00	1	080310135
42	38	62	17000	267.00	1	080310138
50	45	75	25000	467.00	1	080310145
57	50	83	35000	821.00	1	080310150
70	65	105	55000	1,680.00	1	080310165
83	75	127	85000	2,550.00	1	080310183

formats de vente spéciaux pour libre
service

ØD mm	CHF		
16	17.40	1	080319112
19	29.50	1	080319116

8032

Manille lyre haute résistance
en acier allié,
axe carré femelle,
bride galvanisée à chaud

CE



GRADE 6

CARACTÉRISTIQUE TECHNIQUES

- coefficient de sécurité minimum: 6
- traitement thermique: bonification
- code lot de fabrication sur pivot et bride
- ANALYSES DE LABORATOIRE
- analyse chimique
- analyse métallographique
- essai de traction
- essai de fatigue (min. 20.000 cycles)
- test charge d'essai (WLL x 2)
- CERTIFICATS DISPONIBLES
- Spécification produit
- Rapport d'essai type 2.2 UNI EN10204
- Certificat de contrôle type 3.1 UNI EN10204
- Déclaration de Conformité CE

ØD mm	ØA mm	H mm	WLL kg	CHF		
11	10	17	1000	10.60	5	080320010
16	13	21	2000	13.40	5	080320012
19	16	27	3250	24.40	3	080320016
22	19	32	4750	42.00	2	080320020
25	22	37	6500	61.50	2	080320022

formats de vente spéciaux pour libre
service

ØD mm	CHF		
16	16.10	1	080329012
19	26.50	1	080329016

8025

Manille droite, type large,
estampée à chaud, zinguée

CE



GRADO 4

CARACTÉRISTIQUES TECHNIQUES

- coefficient de sécurité : 5
- traitement thermique : normalisation
- code lot de fabrication
- ANALYSES DE LABORATOIRE
- analyse chimique • analyse métallographique
- essai de traction
- CERTIFICATS DISPONIBLES
- Spécification produit • Rapport d'essai type 2.2 UNI EN10204
- Certificat de contrôle type 3.1 UNI EN10204
- Déclaration de Conformité CE

Ø mm	≈ "	B x C mm	WLL kg	CHF		
5	3/16	21x10	70	1.88	250	080250005
6	1/4	25x12	100	2.53	250	080250006
8	5/16	33x16	250	4.20	150	080250008
10	3/8	42x20	400	4.65	180	080250010
11	7/16	46x22	500	5.70	130	080250011
12	1/2	50x24	600	6.15	100	080250012
14	9/16	57x28	800	8.00	70	080250014
16	5/8	61x32	1000	10.40	10	080250016
18	11/16	65x36	1300	15.10	10	080250018
20	3/4	70x40	1600	17.70	10	080250020
22	7/8	74x44	2000	24.60	10	080250022
25	1"	80x48	2800	33.00	2	080250025

Emballages spéciaux

Ø mm	"	📦	CHF	📦	🚚
5	3/16	25	46.50	1	080250705
6	1/4	25	63.00	1	080250706
8	5/16	25	105.50	1	080250708
10	3/8	15	69.50	1	080250710
11	7/16	12	68.00	1	080250711
12	1/2	12	73.50	1	080250712
14	9/16	10	80.00	1	080250714

formats de vente spéciaux pour libre service



Ø mm	📦	CHF	📦	🚚
5	4	9.45	1	080259205
6	4	12.00	1	080259206
8	2	10.10	1	080259208
10	2	10.80	1	080259210
11	1	7.05	1	080259011
12	1	7.70	1	080259012
14	1	9.45	1	080259014
16	1	11.90	1	080259016
18	1	17.70	1	080259018
20	1	20.00	1	080259020
22	1	26.00	1	080259022
25	1	34.00	1	080259025

8026A

Manille droite, type UNI 1947, estampée à chaud, zinguée

CE

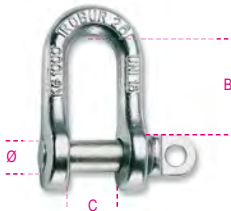

GRADO 4

CARACTÉRISTIQUES TECHNIQUES

- coefficient de sécurité : 5
- traitement thermique : normalisation
- code lot de fabrication

ANALYSES DE LABORATOIRE

- analyse chimique
- analyse métallographique
- essai de traction

CERTIFICATS DISPONIBLES

- Spécification produit
- Rapport d'essai type 2.2 UNI EN10204
- Certificat de contrôle type 3.1 UNI EN10204
- Déclaration de Conformité CE

Ø mm	"	B x C mm	WLL kg	CHF	📦	🚚
12	1/2	42x20	630	5.90	35	080260012
14	9/16	46x22	800	7.30	30	080260014
16	5/8	50x24	1000	9.45	20	080260016
18	11/16	54x26	1300	13.30	15	080260018
20	3/4	58x28	1600	16.70	10	080260020
22	7/8	69x32	2000	22.00	10	080260022
25	1"	79x36	2500	31.00	5	080260025
28	1.1/8	90x40	3150	42.50	2	080260028
32	1.1/4	100x45	4000	59.00	1	080260032
36	1.3/8	110x50	5000	84.50	1	080260036
40	1.9/16	120x55	6300	116.50	1	080260040
42	1.5/8	131x60	8000	159.50	1	080260042
45	1.3/4	143x65	10000	217.50	1	080260045
50	2"	155x70	12500	270.00	1	080260050

formats de vente spéciaux pour libre service



Ø mm	📦	CHF	📦	🚚
12	1	7.55	1	080269012
14	1	9.05	1	080269014
16	1	10.60	1	080269016
18	1	16.10	1	080269018
20	1	19.20	1	080269020
22	1	24.60	1	080269022
25	1	34.00	1	080269025

8028

Manille lyre, estampée à chaud, zinguée

CE

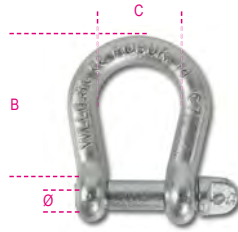

GRADO 4

CARACTÉRISTIQUES TECHNIQUES

- coefficient de sécurité : 5
- traitement thermique : normalisation
- code lot de fabrication

ANALYSES DE LABORATOIRE

- analyse chimique
- analyse métallographique
- essai de traction

CERTIFICATS DISPONIBLES

- Spécification produit
- Rapport d'essai type 2.2 UNI EN10204
- Certificat de contrôle type 3.1 UNI EN10204
- Déclaration de Conformité CE

Ø mm	"	B x C mm	WLL kg	CHF	📦	🚚
5	3/16	20x16	80	1.62	100	080280105
6	1/4	24x20	100	2.41	70	080280106
8	5/16	32x24	200	4.15	35	080280108
10	3/8	40x33	300	4.80	25	080280110
12	1/2	48x39	500	7.55	15	080280112
14	9/16	56x46	600	10.80	7	080280114
16	5/8	64x46	800	16.30	10	080280116
18	11/16	71x59	950	20.00	5	080280118
20	3/4	80x65	1100	28.50	5	080280120
22	7/8	88x72	1500	36.00	5	080280122
25	1"	100x81	2000	55.00	2	080280125
28	1.1/8	112x91	2600	85.50	1	080280128
32	1.1/4	128x104	3200	117.00	1	080280132
38	1.1/2	152x124	4500	233.00	1	080280138

formats de vente spéciaux pour libre service



Ø mm	📦	CHF	📦	🚚
5	4	8.00	1	080289305
6	4	11.50	1	080289306
8	2	10.40	1	080289308
10	2	11.20	1	080289310
12	1	9.25	1	080289112
14	1	12.40	1	080289114
16	1	17.60	1	080289116
18	1	22.30	1	080289118
20	1	31.00	1	080289120
22	1	39.50	1	080289122

8049 WLL (t)

	A°	M8	M10	M12	M16	M20	M24	M30
	0°	0,3	0,6	1	1,6	2,5	4	6,3
	90°	0,3	0,6	1	1,6	2,5	4	6,3
	45°	0,4	0,8	1,4	2,2	3,5	5,6	8,8
	60°	0,3	0,6	1	1,6	2,5	4	6,3
	0°	0,6	1,3	2,1	3,4	5,3	8,4	13,2
	46°	0,3	0,6	1	1,6	2,3	4	6,3

8049

Anneau de levage mâle orientable double articulation, acier allié haute résistance

CE

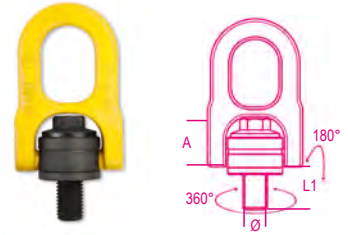

CARACTÉRISTIQUES TECHNIQUES

- coefficient de sécurité : 5
- traitement thermique : bonification
- code lot de fabrication

ANALYSES DE LABORATOIRE

- analyse chimique
- analyse métallographique
- essai de traction

CERTIFICATS DISPONIBLES

- Spécification produit
- Rapport d'essai type 2.2 UNI EN10204
- Certificat de contrôle type 3.1 UNI EN10204
- Déclaration de Conformité CE

Ø mm	A mm	L1 mm	WLL 90° kg	CHF	📦	🚚
M8	31,5	14	300	161.00	1	080490008
M10	31,5	17	600	168.00	1	080490010
M12	31,5	21	1000	172.50	1	080490012
M16	45	27	1600	198.50	1	080490016
M20	45	30	2500	203.50	1	080490020
M24	60,5	36	4000	348.00	1	080490024
M30	60,5	45	6300	363.00	1	080490030

Robur

8049A WLL (t)

	Ø"	M6	M8	M10	M12	M16	M20	M24	M30	M36
	0°	400	600	900	1000	2000	4000	6300	10600	11800
	0°	800	1200	1800	2000	4000	8000	12600	21200	23600
	90°	200	300	450	500	1120	2000	3150	5300	8000
	90°	400	600	900	1000	2000	4000	6300	10600	16000
	0° 45°	250	400	600	700	1400	2800	4250	7100	10700
	45° 60°	200	300	450	500	1120	2000	3150	5300	8000
	0° 45°	400	600	900	1000	2100	4200	6300	11200	16000
	45° 60°	250	400	600	750	1500	3000	4750	8000	10700

8049A

Anneau de levage mâle orientable double articulation, pivotant sous charge avec anneau soudé, acier allié haute résistance

CE



CARACTÉRISTIQUES TECHNIQUES

- Coefficient de sécurité : 4
 - Traitement thermique : bonification
 - Code lot de fabrication
- ANALYSES DE LABORATOIRE
- Analyse chimique
 - Analyse métallographique
 - Essai de traction
 - Essai de fatigue (20.000 cycles)
 - Charge d'essai (100% du lot)
- CERTIFICATS DISPONIBLES
- Spécification produit
 - Rapport d'essai type 2.2 UNI EN10204
 - Certificat de contrôle type 3.1 UNI EN10204
 - Déclaration de Conformité CE

Ø	E	A	WLL 90°	CHF		
mm	mm	mm	kg			
M6	13	30	200	53.50	1	080490106
M8	13	30	300	54.50	1	080490108
M10	19	30	450	57.00	1	080490110
M12	19	30	500	60.50	1	080490112
M16	20	30	1120	64.50	1	080490116
M20	30	40	2000	93.00	1	080490120
M24	30	40	3150	136.50	1	080490124
M30	35	50	5300	235.50	1	080490130
M36	54	50	8000	248.00	1	080490136

8049V

Anneau de levage avec support décalé
Alliage d'acier haute résistance
anneau pivotant à 360° et support pivotant

CE



DONNÉES TECHNIQUES

- facteur de sécurité: 4
- traitement thermique : durcissement et revenu
- code de traçabilité TESTS DE LABORATOIRE
- analyse chimique
- analyse métallographique
- essai de traction
- essai de fatigue (20 000 cycles)
- charge d'essai (100% du lot) CERTIFICATS DISPONIBLES
- Spécifications techniques du produit
- Rapport d'essai UNI EN10204 type 2.2
- Certificat d'inspection UNI EN10204 type 3.1
- Déclaration de conformité CE

Ø	E	B	WLL	CHF		
mm	mm	mm	kg			
M12	18	37,5	1000	109.00	1	080490312
M16	24	37,5	1500	116.50	1	080490316
M20	35,5	54	2500	169.00	1	080490320
M24	35,5	54	4000	174.00	1	080490324

8068S

Étrier à souder pour le levage
base simple avec ressort de positionnement,
corps en acier allié à haute résistance

- Encombrement minimal pour les opérations de levage
- Dimensionné pour 20.000 cycles de travail à pleine charge
- Test de charge appliqué sur 100 % des pièces avant vente
- Coefficient de sécurité 4 dans toutes les directions

CE



CARACTÉRISTIQUES TECHNIQUES

- Coefficient de sécurité : 4
 - Traitement thermique : bonification
 - Code lot de fabrication
- ANALYSES DE LABORATOIRE
- Analyse chimique
 - Analyse métallographique
 - Essai de traction
 - Essai de fatigue (20.000 cycles)
 - Test charge d'essai (100% du lot)
- CERTIFICATS DISPONIBLES
- Spécifications techniques du produit
 - Rapport d'essai type 2.2 UNI EN10204
 - Certificat de contrôle type 3.1 UNI EN10204
 - Déclaration de Conformité CE

WLL	B	M	A	CHF		
Kg	mm	mm	mm			
1500	78	37	41	13.20	1	080680115
2500	88	40	42	17.20	1	080680125
4000	94	42	45	24.70	1	080680140
6700	118	51	55	46.00	1	080680167

Attention :

- L'élément de couplage doit garantir une résistance mécanique suffisante et être apte au soudage.
- Le soudage doit être effectué par un personnel compétent et dûment instruit.

8041

Anneau de levage mâle
en acier allié, traitement thermique
d'amélioration

CE



CARACTÉRISTIQUES TECHNIQUES

- coefficient de sécurité : 4
 - traitement thermique : normalisation
 - code lot de fabrication
- ANALYSES DE LABORATOIRE
- analyse chimique
 - analyse métallographique
 - essai de traction
 - essai de fatigue (20.000 cycles)
 - test charge d'essai (100% du lot)
- CERTIFICATS DISPONIBLES
- Spécification produit
 - Rapport d'essai type 2.2 UNI EN10204
 - Certificat de contrôle type 3.1 UNI EN10204
 - Déclaration de Conformité CE

Ø	E	WLL	CHF			
mm	mm	kg				
M6	11	400	4.35	10	080410206	
* M8	1,25	13	800	4.35	10	080410208
* M10	1,5	17	1000	6.70	6	080410210
* M12	1,75	20,5	1600	10.10	4	080410212
M14	2	20,5	3000	16.70	2	080410214
M16	2,5	30	4000	25.50	2	080410217
M18	2,5	27	5000	25.50	2	080410218
M20	3,0	36	6000	47.00	2	080410221
M22	2,5	30	7000	47.00	2	080410222
M24	3	41	8000	57.00	2	080410225
M27	3	41	10000	87.00	1	080410227
* M30	3,5	45	12000	87.00	1	080410230

(*) Caractéristiques dimensionnelles DIN 580:2010
WLL augmenté en fonction du Fascicule Technique Robur

formats de vente spéciaux pour libre service

Ø	CHF			
mm				
* M8	1	6.95	1	080419208
* M10	1	9.75	1	080419210
* M12	1	13.40	1	080419212

Robur

Robur

8043

Anneau de levage femelle en acier allié, traitement thermique d'amélioration

CE

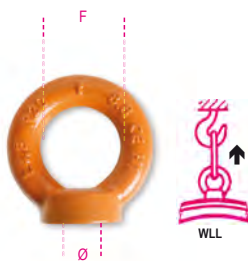

CARACTÉRISTIQUES TECHNIQUES

- coefficient de sécurité : 4
- traitement thermique : normalisation
- code lot de fabrication

ANALYSES DE LABORATOIRE

- analyse chimique
- analyse métallographique
- essai de traction
- essai de fatigue (20.000 cycles)
- test charge d'essai (100% du lot)

CERTIFICATS DISPONIBLES

- Spécification produit
- Rapport d'essai type 2.2 UNI EN10204
- Certificat de contrôle type 3.1 UNI EN10204
- Déclaration de Conformité CE

Ø mm	F mm	WLL kg	CHF		
M6	1	20	4.20	10	080430206
* M8	1,25	20	8.00	10	080430208
* M10	1,50	25	10.00	6	080430210
* M12	1,75	30	16.00	4	080430212
M14	2	35	30.00	2	080430214
M16	2,5	40	40.00	2	080430217
M18	2,5	40	50.00	2	080430218
M20	2,5	50	60.00	2	080430221
M22	2,5	50	70.00	2	080430222
M24	3	55	80.00	2	080430225
M27	3	60	100.00	1	080430227
* M30	3,5	60	120.00	1	080430230

(*) Caractéristiques dimensionnelles DIN 582:2010
WLL augmenté en fonction du Fascicule Technique Robur

formats de vente spéciaux pour libre service

Ø mm	CHF		
* M8	6.60	1	080439208
* M10	9.45	1	080439210
* M12	12.80	1	080439212

8040EZ

Anneau de levage mâle galvanisé

CE

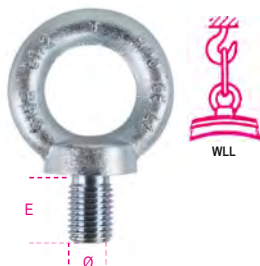

DIN 580:2018-04(**)

DONNEES TECHNIQUES

- facteur de sécurité : 6
- traitement thermique : normalisation
- codes de traçabilité

ESSAIS EN LABORATOIRE

- analyse chimique
- analyse métallographique
- essais de traction

CERTIFICATS DISPONIBLES

- Spécifications techniques du produit
- Rapport d'essai UNI EN10204 type 2.2
- Certificat d'inspection UNI EN10204 type 3.1
- Déclaration de conformité CE

Ø mm	F mm	E mm	WLL kg	CHF		
* M6	1	11	90	2.36	60	080400406
M8	1,25	13	140	2.36	60	080400408
M10	1,5	17	230	3.15	40	080400410
M12	1,75	20,5	340	4.20	20	080400412
* M14	2	20,5	480	5.60	20	080400414
M16	2	27	700	6.95	10	080400416
* M18	2,5	27	930	8.45	10	080400418
M20	2,5	30	1200	10.80	10	080400420
* M22	2,5	30	1450	13.90	10	080400422
M24	3	36	1800	20.50	5	080400424
* M27	3	41	2400	25.50	5	080400427
M30	3,5	45	3200	42.00	2	080400430
* M33	3,5	54	3900	59.00	2	080400433
* M33F	2	54	3900	59.00	2	080400434
M36	4	54	4600	60.50	2	080400436
* M36F	3	54	4600	60.50	2	080400437
M42	4,5	63	6300	111.50	1	080400442
* M42F	3	63	6300	111.50	1	080400443
M48	5	68	8600	179.00	1	080400448
* M48F	3	68	8600	179.00	1	080400449
M56	5,5	78	11500	293.00	1	080400456
* M56F	4	78	11500	293.00	1	080400457
M64	6	90	16000	430.00	1	080400464
* M64F	4	90	16000	430.00	1	080400465

*Tailles dimensionnées selon la fiche technique ROBUR

formats de vente spéciaux pour libre service

Ø mm	CHF		
M6	11.70	1	080409606
M8	11.70	1	080409608
M10	8.75	1	080409610
M12	6.00	1	080409412
* M14	7.05	1	080409414
M16	8.75	1	080409416
* M18	10.30	1	080409418
M20	12.40	1	080409420
* M22	16.40	1	080409422
M24	22.10	1	080409424
* M27	27.50	1	080409427
M30	43.50	1	080409430

8040EN

Anneau de levage mâle unicolor

CE



DIN 580:2018-04(**)

DONNEES TECHNIQUES

- facteur de sécurité : 6
- traitement thermique : normalisation
- codes de traçabilité

ESSAIS EN LABORATOIRE

- analyse chimique
- analyse métallographique
- essais de traction

CERTIFICATS DISPONIBLES

- Spécifications techniques du produit
- Rapport d'essai UNI EN10204 type 2.2
- Certificat d'inspection UNI EN10204 type 3.1
- Déclaration de conformité CE

Ø mm	F mm	E mm	WLL kg	CHF		
* M6	1	11	90	2.27	60	080400306
M8	1,25	13	140	2.27	60	080400308
M10	1,5	17	230	3.10	40	080400310
M12	1,75	20,5	340	4.20	20	080400312
* M14	2	20,5	480	5.25	20	080400314
M16	2	27	700	6.60	10	080400316
* M18	2,5	27	930	8.20	10	080400318
M20	2,5	30	1200	10.10	10	080400320
* M22	2,5	30	1450	13.30	10	080400322
M24	3	36	1800	18.70	5	080400324
* M27	3	41	2400	23.60	5	080400327
M30	3,5	45	3200	39.50	2	080400330
* M33	3,5	54	3900	55.00	2	080400333
* M33F	2	54	3900	55.00	2	080400334
M36	4	54	4600	58.00	2	080400336
* M36F	3	54	4600	58.00	2	080400337
M42	4,5	63	6300	107.00	1	080400342
* M42F	3	63	6300	107.00	1	080400343
M48	5	68	8600	175.50	1	080400348
* M48F	3	68	8600	175.50	1	080400349
M56	5,5	78	11500	280.00	1	080400356
* M56F	4	78	11500	280.00	1	080400357
M64	6	90	16000	407.00	1	080400364
* M64F	4	90	16000	407.00	1	080400365

*Tailles dimensionnées selon la fiche technique ROBUR

formats de vente spéciaux pour libre service

Ø mm	CHF		
M6	11.00	1	080409506
M8	11.00	1	080409508
M10	8.05	1	080409510
M12	5.70	1	080409312
* M14	6.80	1	080409314
M16	8.05	1	080409316
* M18	9.60	1	080409318
M20	11.20	1	080409320
* M22	15.30	1	080409322
M24	20.50	1	080409324
* M27	25.50	1	080409327
M30	41.00	1	080409330

8042EZ

Anneau de levage femelle galvanisé

CE



DIN582:2018-04(**)

DONNEES TECHNIQUES

- facteur de sécurité : 6
- traitement thermique : normalisation
- codes de traçabilité

ESSAIS EN LABORATOIRE

- analyse chimique
- analyse métallographique
- essais de traction

CERTIFICATS DISPONIBLES

- Spécifications techniques du produit
- Rapport d'essai UNI EN10204 type 2.2
- Certificat d'inspection UNI EN10204 type 3.1
- Déclaration de conformité CE

Ø mm	mm	F mm	WLL kg	CHF		
* M6	1	14	90	2.36	60	080420406
M8	1,25	20	140	2.36	60	080420408
M10	1,5	25	230	3.15	40	080420410
M12	1,75	30	340	4.35	30	080420412
* M14	2	30	480	5.60	30	080420414
M16	2	35	700	6.95	20	080420416
* M18	2,5	35	930	8.45	20	080420418
M20	2,5	40	1200	10.60	10	080420420
* M22	2,5	40	1450	13.80	10	080420422
M24	3	50	1800	20.50	5	080420424
* M27	3	55	2400	24.60	5	080420427
M30	3,5	60	3200	39.50	3	080420430
M36	4	70	4600	60.00	2	080420436
* M36F	3	70	4600	60.00	2	080420437
M42	4,5	80	6300	109.00	1	080420442
* M42F	3	80	6300	109.00	1	080420443
M48	5	90	8600	176.50	1	080420448
* M48F	3	90	8600	176.50	1	080420449

*Tailles dimensionnées selon la fiche technique ROBUR

formats de vente spéciaux pour libre service



Ø mm		CHF		
M6	4	11.40	1	080429606
M8	4	11.40	1	080429608
M10	2	8.20	1	080429610
M12	1	6.00	1	080429412
* M14	1	6.80	1	080429414
M16	1	8.45	1	080429416
* M18	1	9.75	1	080429418
M20	1	12.00	1	080429420
* M22	1	15.30	1	080429422
M24	1	23.60	1	080429424
* M27	1	26.00	1	080429427
M30	1	40.50	1	080429430



8042EN

Anneau de levage femelle unicolor

CE



DIN582:2018-04(**)

DONNEES TECHNIQUES

- facteur de sécurité : 6
- traitement thermique : normalisation
- codes de traçabilité

ESSAIS EN LABORATOIRE

- analyse chimique
- analyse métallographique
- essais de traction

CERTIFICATS DISPONIBLES

- Spécifications techniques du produit
- Rapport d'essai UNI EN10204 type 2.2
- Certificat d'inspection UNI EN10204 type 3.1
- Déclaration de conformité CE

Ø mm	mm	F mm	WLL kg	CHF		
* M6	1	14	90	2.27	60	080420306
M8	1,25	20	140	2.27	60	080420308
M10	1,5	25	230	3.00	40	080420310
M12	1,75	30	340	4.20	30	080420312
* M14	2	30	480	5.40	30	080420314
M16	2	35	700	6.35	20	080420316
* M18	2,5	35	930	8.05	20	080420318
M20	2,5	40	1200	9.75	10	080420320
* M22	2,5	40	1450	13.00	10	080420322
M24	3	50	1800	18.70	5	080420324
* M27	3	55	2400	22.70	5	080420327
M30	3,5	60	3200	36.00	3	080420330
M36	4	70	4600	55.00	2	080420336
* M36F	3	70	4600	55.00	2	080420337
M42	4,5	80	6300	102.50	1	080420342
* M42F	3	80	6300	102.50	1	080420343
M48	5	90	8600	168.00	1	080420348
* M48F	3	90	8600	168.00	1	080420349

*Tailles dimensionnées selon la fiche technique ROBUR

formats de vente spéciaux pour libre service



Ø mm		CHF		
M6	4	11.00	1	080429506
M8	4	11.00	1	080429508
M10	2	8.05	1	080429510
M12	1	5.60	1	080429312
* M14	1	6.60	1	080429314
M16	1	8.05	1	080429316
* M18	1	9.45	1	080429318
M20	1	11.40	1	080429320
* M22	1	14.80	1	080429322
M24	1	21.20	1	080429324
* M27	1	25.50	1	080429327
M30	1	38.50	1	080429330

8044

Anneau de levage femelle, UNI 2948

noir

CE



UNI 2948

CARACTÉRISTIQUES TECHNIQUES

- coefficient de sécurité : 4
- traitement thermique : normalisation
- code lot de fabrication

ANALYSES DE LABORATOIRE

- analyse chimique
- analyse métallographique
- essai de traction

CERTIFICATS DISPONIBLES

- Spécification produit
- Rapport d'essai type 2.2 UNI EN10204
- Certificat de contrôle type 3.1 UNI EN10204
- Déclaration de Conformité CE

Ø mm	mm	WLL kg	CHF		
M8	1,25	80	3.00	4	080440008
M10	1,5	160	4.90	4	080440010
M12	1,75	250	8.60	4	080440012
M14	2	250	13.90	2	080440014
M16	2	400	14.00	2	080440016
M20	2,5	630	23.60	2	080440020
M24	3	1000	41.00	2	080440024



WLL Ton		UNI EN 818	
Ø D mm	WLL 1	WLL 2	
		0° < β ≤ 45°	45° < β ≤ 60°
6	1,12	1,6	1,12
7	1,5	2,12	1,5
8	2	2,8	2
10	3,15	4,25	3,15
13	5,3	7,5	5,3
16	8	11,2	8

Ø D mm	WLL 3	WLL 3	
		0° < β ≤ 45°	45° < β ≤ 60°
6	2,36	1,7	
7	3,15	2,24	
8	4,25	3	
10	6,7	4,75	
13	11,2	8	
16	17	11,2	

8091

Élingue chaîne à un brin
grade 8

CE

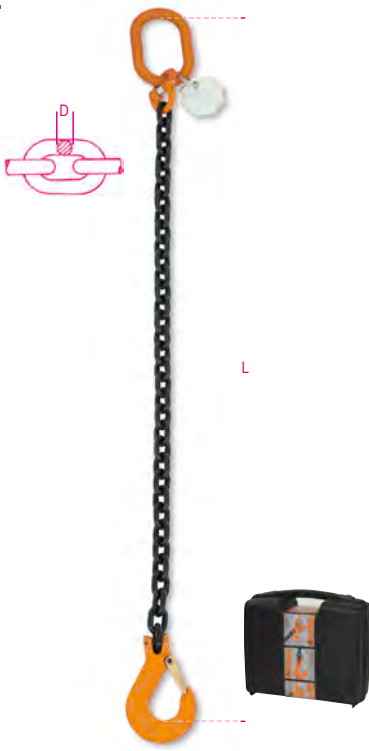

UNI EN 818-4

CARACTÉRISTIQUES TECHNIQUES

- coefficient de sécurité : 4
 - plaque d'identification série
- CERTIFICATS ANNEXES**
- Certificat du Fabricant UNI EN818-4
 - Déclaration de Conformité CE
- CERTIFICATS DISPONIBLES**
- Spécification produit

D mm	L m	WLL ton	CHF		
6*	1	1,12	106.00	1	080910001
6*	2	1,12	130.00	1	080910002
6*	3	1,12	153.50	1	080910003
6*	4	1,12	177.50	1	080910004
7*	1	1,5	116.00	1	080910021
7*	2	1,5	146.50	1	080910022
7*	3	1,5	176.50	1	080910023
7*	4	1,5	207.00	1	080910024
8*	1	2	129.50	1	080910041
8*	2	2	165.50	1	080910042
8*	3	2	201.50	1	080910043
8*	4	2	254.00	1	080910044
10*	1	3,15	165.50	1	080910051
10*	2	3,15	219.00	1	080910052
10*	3	3,15	288.00	1	080910053
10*	4	3,15	342.00	1	080910054
13*	1	5,3	267.00	1	080910131
13*	2	5,3	358.00	1	080910132
13*	3	5,3	445.00	1	080910133
13*	4	5,3	537.00	1	080910134
16*	1	8	522.00	1	080910161
16*	2	8	657.00	1	080910162
16*	3	8	796.00	1	080910163
16*	4	8	935.00	1	080910164
20	1	12,5	1,019.00	1	080910171
20	2	12,5	1,280.00	1	080910172
20	3	12,5	1,545.00	1	080910173
20	4	12,5	1,810.00	1	080910174

* Emballage en coffret

8091SL

Élingue chaîne à 1 brin
chaîne à 1 bras, avec crochet Self-Locking,
grade 8

CE

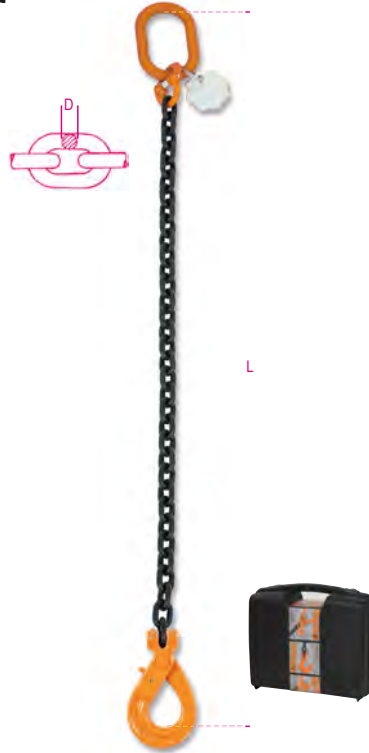

UNI EN 818-4

CARACTÉRISTIQUES TECHNIQUES

- Coefficient de sécurité : 4
 - Plaque d'identification série
- CERTIFICATS ANNEXES**
- Certificat du Fabricant UNI EN818-4
 - Déclaration de Conformité CE
- CERTIFICATS DISPONIBLES**
- Spécification Produit

D mm	L m	WLL ton	CHF		
6*	1	1,12	134.00	1	080910201
6*	2	1,12	157.50	1	080910202
6*	3	1,12	181.00	1	080910203
6*	4	1,12	204.50	1	080910204
7*	1	1,5	153.00	1	080910221
7*	2	1,5	183.50	1	080910222
7*	3	1,5	214.00	1	080910223
7*	4	1,5	244.00	1	080910224
8*	1	2	166.50	1	080910241
8*	2	2	195.50	1	080910242
8*	3	2	238.50	1	080910243
8*	4	2	291.00	1	080910244
10*	1	3,15	208.50	1	080910251
10*	2	3,15	262.00	1	080910252
10*	3	3,15	331.00	1	080910253
10*	4	3,15	401.00	1	080910254
13*	1	5,3	366.00	1	080910331
13*	2	5,3	485.00	1	080910332
13*	3	5,3	548.00	1	080910333
13*	4	5,3	663.00	1	080910334
16*	1	8	688.00	1	080910361
16*	2	8	866.00	1	080910362
16*	3	8	963.00	1	080910363
16*	4	8	1,143.00	1	080910364
20	1	12,5	1,610.00	1	080910401
20	2	12,5	1,870.00	1	080910402
20	3	12,5	2,140.00	1	080910403
20	4	12,5	2,400.00	1	080910404

* Emballage en coffret

8092

Élingue chaîne à deux brins
grade 8

CE



UNI EN 818-4

CARACTÉRISTIQUES TECHNIQUES

- coefficient de sécurité : 4
 - plaque d'identification série
- CERTIFICATS ANNEXES**
- Certificat du Fabricant UNI EN818-4
 - Déclaration de Conformité CE
- CERTIFICATS DISPONIBLES**
- Spécification produit

D mm	L m	WLL ton	CHF		
6*	1	1,6	155.50	1	080920001
6*	2	1,6	203.50	1	080920002
6*	3	1,6	250.00	1	080920003
6*	4	1,6	314.00	1	080920004
7*	1	2,12	181.00	1	080920021
7*	2	2,12	242.00	1	080920022
7*	3	2,12	319.00	1	080920023
7*	4	2,12	379.00	1	080920024
8*	1	2,8	205.00	1	080920041
8*	2	2,8	277.00	1	080920042
8*	3	2,8	365.00	1	080920043
8*	4	2,8	436.00	1	080920044
10*	1	4,25	297.00	1	080920051
10*	2	4,25	403.00	1	080920052
10*	3	4,25	507.00	1	080920053
10*	4	4,25	614.00	1	080920054
13*	1	7,5	472.00	1	080920131
13*	2	7,5	652.00	1	080920132
13	3	7,5	808.00	1	080920133
13	4	7,5	1,054.00	1	080920134
16*	1	11,2	947.00	1	080920161
16	2	11,2	1,260.00	1	080920162
16	3	11,2	1,535.00	1	080920163
16	4	11,2	1,815.00	1	080920164
20	2	17,0	2,550.00	1	080920172
20	3	17,0	3,080.00	1	080920173
20	4	17,0	3,610.00	1	080920174

* Emballage en coffret



8092SL

Élingue chaîne à 2 brins, avec crochet Self-Locking, grade 8

CE



UNI EN 818-4

CARACTÉRISTIQUES TECHNIQUES

- Coefficient de sécurité : 4
 - Plaque d'identification série
- CERTIFICATS ANNEXES
- Certificat du Fabricant UNI EN818-4
 - Déclaration de Conformité CE
- CERTIFICATS DISPONIBLES
- Spécification Produit

D mm	L m	WLL ton	CHF	📦	🚚
6*	1	1,6	211.00	1	080920201
6*	2	1,6	248.50	1	080920202
6*	3	1,6	296.00	1	080920203
6*	4	1,6	370.00	1	080920204
7*	1	2,12	254.00	1	080920221
7*	2	2,12	303.00	1	080920222
7*	3	2,12	392.00	1	080920223
7*	4	2,12	453.00	1	080920224
8*	1	2,8	265.00	1	080920241
8*	2	2,8	352.00	1	080920242
8*	3	2,8	424.00	1	080920243
8*	4	2,8	511.00	1	080920244
10*	1	4,25	414.00	1	080920251
10*	2	4,25	489.00	1	080920252
10*	3	4,25	593.00	1	080920253
10*	4	4,25	730.00	1	080920254
13*	1	7,5	727.00	1	080920331
13*	2	7,5	857.00	1	080920332
13*	3	7,5	1,063.00	1	080920333
13*	4	7,5	1,305.00	1	080920334
16*	1	11,2	1,365.00	1	080920361
16*	2	11,2	1,680.00	1	080920362
16*	3	11,2	1,960.00	1	080920363
16*	4	11,2	2,230.00	1	080920364
20	2	17,0	4,130.00	1	080920402
20	3	17,0	4,650.00	1	080920403
20	4	17,0	5,180.00	1	080920404

* Emballage en coffret

8094

Élingue chaîne à quatre brins grade 8

CE



UNI EN 818-4

CARACTÉRISTIQUES TECHNIQUES

- coefficient de sécurité : 4
 - plaque d'identification série
- CERTIFICATS ANNEXES
- Certificat du Fabricant UNI EN818-4
 - Déclaration de Conformité CE
- CERTIFICATS DISPONIBLES
- Spécification produit

D mm	L m	WLL ton	CHF	📦	🚚
6*	1	2,36	324.00	1	080940001
6*	2	2,36	434.00	1	080940002
6*	3	2,36	529.00	1	080940003
6*	4	2,36	620.00	1	080940004
7*	1	3,15	379.00	1	080940021
7*	2	3,15	501.00	1	080940022
7*	3	3,15	619.00	1	080940023
7*	4	3,15	740.00	1	080940024
8*	1	4,25	458.00	1	080940041
8*	2	4,25	598.00	1	080940042
8*	3	4,25	742.00	1	080940043
8	4	4,25	923.00	1	080940044
10*	1	6,7	603.00	1	080940051
10	2	6,7	832.00	1	080940052
10	3	6,7	1,066.00	1	080940053
10	4	6,7	1,280.00	1	080940054
13	1	11,2	1,004.00	1	080940131
13	2	11,2	1,370.00	1	080940132
13	3	11,2	1,730.00	1	080940133
13	4	11,2	2,095.00	1	080940134
16	1	17	1,970.00	1	080940161
16	2	17	2,520.00	1	080940162
16	3	17	3,080.00	1	080940163
16	4	17	3,630.00	1	080940164
20	2	26,5	4,630.00	1	080940172
20	3	26,5	5,680.00	1	080940173
20	4	26,5	6,720.00	1	080940174

* Emballage en coffret

8094SL

Élingue chaîne à 4 brins, avec crochet Self-Locking, grade 8

CE



UNI EN 818-4

CARACTÉRISTIQUES TECHNIQUES

- Coefficient de sécurité : 4
 - Plaque d'identification série
- CERTIFICATS ANNEXES
- Certificat du Fabricant UNI EN818-4
 - Déclaration de Conformité CE
- CERTIFICATS DISPONIBLES
- Spécification Produit

D mm	L m	WLL ton	CHF	📦	🚚
6*	1	2,36	434.00	1	080940201
6*	2	2,36	544.00	1	080940202
6*	3	2,36	640.00	1	080940203
6*	4	2,36	730.00	1	080940204
7*	1	3,15	526.00	1	080940221
7*	2	3,15	647.00	1	080940222
7*	3	3,15	766.00	1	080940223
7*	4	3,15	888.00	1	080940224
8*	1	4,25	577.00	1	080940241
8*	2	4,25	717.00	1	080940242
8*	3	4,25	889.00	1	080940243
8	4	4,25	1,070.00	1	080940244
10*	1	6,7	785.00	1	080940251
10	2	6,7	1,003.00	1	080940252
10	3	6,7	1,250.00	1	080940253
10	4	6,7	1,460.00	1	080940254
13	1	11,2	1,420.00	1	080940331
13	2	11,2	1,785.00	1	080940332
13	3	11,2	2,145.00	1	080940333
13	4	11,2	2,510.00	1	080940334
16	1	17	2,670.00	1	080940361
16	2	17	3,220.00	1	080940362
16	3	17	3,780.00	1	080940363
16	4	17	4,330.00	1	080940364
20	2	26,5	6,990.00	1	080940402
20	3	26,5	8,040.00	1	080940403
20	4	26,5	9,090.00	1	080940404

* Emballage en coffret

8096

Élingue chaîne à un brin,
avec raccourcisseur,
grade 8

CE



UNI EN 818-4

CARACTÉRISTIQUES TECHNIQUES

- coefficient de sécurité : 4
 - plaque d'identification série
- CERTIFICATS ANNEXES**
- Certificat du Fabricant UNI EN818-4
 - Déclaration de Conformité CE
- CERTIFICATS DISPONIBLES**
- Spécification produit

D mm	L m	WLL ton	CHF		
6*	1	1,12	126.00	1	080960001
6*	2	1,12	149.50	1	080960002
6*	3	1,12	173.00	1	080960003
6*	4	1,12	192.00	1	080960004
7*	1	1,5	139.50	1	080960021
7*	2	1,5	170.00	1	080960022
7*	3	1,5	194.00	1	080960023
7*	4	1,5	224.50	1	080960024
8*	1	2	153.50	1	080960041
8*	2	2	189.50	1	080960042
8*	3	2	225.50	1	080960043
8*	4	2	278.00	1	080960044
10*	1	3,15	212.50	1	080960051
10*	2	3,15	282.00	1	080960052
10*	3	3,15	335.00	1	080960053
10*	4	3,15	388.00	1	080960054
13*	1	5,3	348.00	1	080960131
13*	2	5,3	413.00	1	080960132
13*	3	5,3	500.00	1	080960133
13*	4	5,3	619.00	1	080960134
16*	1	8	686.00	1	080960161
16*	2	8	780.00	1	080960162
16*	3	8	919.00	1	080960163
16	4	8	1,095.00	1	080960164
20	1	12,5	1,390.00	1	080960171
20	2	12,5	1,655.00	1	080960172
20	3	12,5	1,915.00	1	080960173
20	4	12,5	2,175.00	1	080960174

* Emballage en coffret

8096SL

Élingue chaîne à 1 brin,
avec crochet Self-Locking et raccourcisseurs,
grade 8

CE



UNI EN 818-4

CARACTÉRISTIQUES TECHNIQUES

- Coefficient de sécurité : 4
 - Plaque d'identification série
- CERTIFICATS ANNEXES**
- Certificat du Fabricant UNI EN818-4
 - Déclaration de Conformité CE
- CERTIFICATS DISPONIBLES**
- Spécification Produit

D mm	L m	WLL ton	CHF		
6*	1	1,12	149.00	1	080960201
6*	2	1,12	172.50	1	080960202
6*	3	1,12	196.00	1	080960203
6*	4	1,12	219.50	1	080960204
7*	1	1,5	170.00	1	080960221
7*	2	1,5	200.00	1	080960222
7*	3	1,5	230.50	1	080960223
7*	4	1,5	261.00	1	080960224
8*	1	2	183.50	1	080960241
8*	2	2	219.50	1	080960242
8*	3	2	255.00	1	080960243
8*	4	2	308.00	1	080960244
10*	1	3,15	255.00	1	080960251
10*	2	3,15	325.00	1	080960252
10*	3	3,15	378.00	1	080960253
10*	4	3,15	432.00	1	080960254
13*	1	5,3	448.00	1	080960331
13*	2	5,3	539.00	1	080960332
13*	3	5,3	626.00	1	080960333
13*	4	5,3	718.00	1	080960334
16*	1	8	853.00	1	080960361
16*	2	8	988.00	1	080960362
16*	3	8	1,127.00	1	080960363
16	4	8	1,260.00	1	080960364
20	1	12,5	1,985.00	1	080960401
20	2	12,5	2,245.00	1	080960402
20	3	12,5	2,500.00	1	080960403
20	4	12,5	2,770.00	1	080960404

* Emballage en coffret

8097

Élingue chaîne à deux brins,
avec raccourcisseurs,
grade 8

CE



UNI EN 818-4

CARACTÉRISTIQUES TECHNIQUES

- coefficient de sécurité : 4
 - plaque d'identification série
- CERTIFICATS ANNEXES**
- Certificat du Fabricant UNI EN818-4
 - Déclaration de Conformité CE
- CERTIFICATS DISPONIBLES**
- Spécification produit

D mm	L m	WLL ton	CHF		
6*	1	1,6	195.50	1	080970001
6*	2	1,6	233.00	1	080970002
6*	3	1,6	290.00	1	080970003
6*	4	1,6	343.00	1	080970004
7*	1	2,12	227.00	1	080970021
7*	2	2,12	292.00	1	080970022
7*	3	2,12	352.00	1	080970023
7*	4	2,12	413.00	1	080970024
8*	1	2,8	254.00	1	080970041
8*	2	2,8	327.00	1	080970042
8*	3	2,8	413.00	1	080970043
8*	4	2,8	485.00	1	080970044
10*	1	4,25	391.00	1	080970051
10*	2	4,25	497.00	1	080970052
10*	3	4,25	600.00	1	080970053
10*	4	4,25	707.00	1	080970054
13*	1	7,5	634.00	1	080970131
13*	2	7,5	816.00	1	080970132
13	3	7,5	981.00	1	080970133
13	4	7,5	1,163.00	1	080970134
16	1	11,2	1,230.00	1	080970161
16	2	11,2	1,505.00	1	080970162
16	3	11,2	1,785.00	1	080970163
16	4	11,2	2,060.00	1	080970164
20	2	17,0	2,950.00	1	080970172
20	3	17,0	3,470.00	1	080970173
20	4	17,0	3,990.00	1	080970174

* Emballage en coffret



8097SL

Élingue chaîne à 2 brins,
avec crochet Self-Locking et raccourcisseurs,
grade 8

CE



UNI EN 818-4

CARACTÉRISTIQUES TECHNIQUES

- Coefficient de sécurité : 4
- Plaque d'identification série
- CERTIFICATS ANNEXES
- Certificat du Fabricant UNI EN818-4
- Déclaration de Conformité CE
- CERTIFICATS DISPONIBLES
- Spécification Produit

D mm	L m	WLL ton	CHF		
6*	1	1,6	240.50	1	080970201
6*	2	1,6	278.00	1	080970202
6*	3	1,6	336.00	1	080970203
6*	4	1,6	399.00	1	080970204
7*	1	2,12	288.00	1	080970221
7*	2	2,12	353.00	1	080970222
7*	3	2,12	414.00	1	080970223
7*	4	2,12	475.00	1	080970224
8*	1	2,8	314.00	1	080970241
8*	2	2,8	387.00	1	080970242
8*	3	2,8	472.00	1	080970243
8*	4	2,8	544.00	1	080970244
10*	1	4,25	476.00	1	080970251
10*	2	4,25	583.00	1	080970252
10*	3	4,25	686.00	1	080970253
10*	4	4,25	792.00	1	080970254
13*	1	7,5	832.00	1	080970331
13*	2	7,5	1,014.00	1	080970332
13	3	7,5	1,235.00	1	080970333
13	4	7,5	1,360.00	1	080970334
16	1	11,2	1,645.00	1	080970361
16	2	11,2	1,920.00	1	080970362
16	3	11,2	2,200.00	1	080970363
16	4	11,2	2,395.00	1	080970364
20	2	17,0	4,130.00	1	080970402
20	3	17,0	4,650.00	1	080970403
20	4	17,0	5,180.00	1	080970404

* Emballage en coffret

8098

Élingue chaîne à quatre brins,
avec raccourcisseurs,
grade 8

CE



UNI EN 818-4

CARACTÉRISTIQUES TECHNIQUES

- coefficient de sécurité : 4
- plaque d'identification série
- CERTIFICATS ANNEXES
- Certificat du Fabricant UNI EN818-4
- Déclaration de Conformité CE
- CERTIFICATS DISPONIBLES
- Spécification produit

D mm	L m	WLL ton	CHF		
6*	1	2,36	402.00	1	080980001
6*	2	2,36	494.00	1	080980002
6*	3	2,36	585.00	1	080980003
6*	4	2,36	680.00	1	080980004
7*	1	3,15	471.00	1	080980021
7*	2	3,15	569.00	1	080980022
7*	3	3,15	687.00	1	080980023
7*	4	3,15	808.00	1	080980024
8*	1	4,25	526.00	1	080980041
8*	2	4,25	666.00	1	080980042
8*	3	4,25	810.00	1	080980043
8	4	4,25	991.00	1	080980044
10*	1	6,7	727.00	1	080980051
10	2	6,7	977.00	1	080980052
10	3	6,7	1,190.00	1	080980053
10	4	6,7	1,405.00	1	080980054
13	1	11,2	1,220.00	1	080980131
13	2	11,2	1,585.00	1	080980132
13	3	11,2	1,970.00	1	080980133
13	4	11,2	2,310.00	1	080980134
16	1	17	2,460.00	1	080980161
16	2	17	3,010.00	1	080980162
16	3	17	3,570.00	1	080980163
16	4	17	4,130.00	1	080980164
20	2	26,5	5,850.00	1	080980172
20	3	26,5	6,910.00	1	080980173
20	4	26,5	7,960.00	1	080980174

* Emballage en coffret

8098SL

Élingue chaîne à 4 brins,
avec crochet Self-Locking et raccourcisseurs,
grade 8

CE



UNI EN 818-4

CARACTÉRISTIQUES TECHNIQUES

- Coefficient de sécurité : 4
- Plaque d'identification série
- CERTIFICATS ANNEXES
- Certificat du Fabricant UNI EN818-4
- Déclaration de Conformité CE
- CERTIFICATS DISPONIBLES
- Spécification Produit

D mm	L m	WLL ton	CHF		
6*	1	2,36	494.00	1	080980201
6*	2	2,36	604.00	1	080980202
6*	3	2,36	676.00	1	080980203
6*	4	2,36	790.00	1	080980204
7*	1	3,15	594.00	1	080980221
7*	2	3,15	692.00	1	080980222
7*	3	3,15	810.00	1	080980223
7*	4	3,15	931.00	1	080980224
8*	1	4,25	673.00	1	080980241
8*	2	4,25	785.00	1	080980242
8	3	4,25	929.00	1	080980243
8*	4	4,25	1,110.00	1	080980244
10*	1	6,7	898.00	1	080980251
10	2	6,7	1,148.00	1	080980252
10	3	6,7	1,360.00	1	080980253
10	4	6,7	1,575.00	1	080980254
13	1	11,2	1,620.00	1	080980331
13	2	11,2	1,985.00	1	080980332
13	3	11,2	2,370.00	1	080980333
13	4	11,2	2,710.00	1	080980334
16	1	17	3,150.00	1	080980361
16	2	17	3,710.00	1	080980362
16	3	17	4,270.00	1	080980363
16	4	17	4,800.00	1	080980364
20	2	26,5	8,220.00	1	080980402
20	3	26,5	9,280.00	1	080980403
20	4	26,5	10,330.00	1	080980404

* Emballage en coffret

Robur

Robur

8100

Chaîne en acier allié, classe 8, traitement thermique d'amélioration

CE

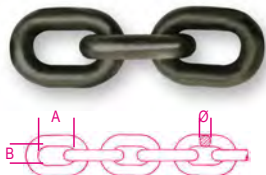

EN 818-2

CARACTÉRISTIQUES TECHNIQUES

- coefficient de sécurité : 4
- traitement thermique : bonification
- code lot de fabrication

ANALYSES DE LABORATOIRE

- analyse chimique
- analyse métallographique
- essai de traction

CERTIFICATS DISPONIBLES

- Spécification produit
- Rapport d'essai type 2.2 UNI EN10204
- Certificat du Fabricant EN818-2
- Déclaration de Conformité CE

WLL	kg	Ø mm	A mm	B min mm	CHF/m		
1120	6	18	7,8	25.00	1	081000011	
1500	7	21	11,0	32.00	1	081000016	
2000	8	24	12,0	38.00	1	081000020	
3150	10	30	14,5	56.50	1	081000032	
5300	13	39	20,0	96.50	1	081000053	
8000	16	48	20,8	147.00	1	081000080	
12500	20	60	26,0	263.00	1	081000125	

8085R

Anneau de tête simple en acier allié, traitement thermique d'amélioration

CE



EN 1677-4
GRADO 8

CARACTÉRISTIQUES TECHNIQUES

- Coefficient de sécurité : 4
- Traitement thermique : bonification
- Code lot de fabrication

ANALYSES DE LABORATOIRE

- Analyse chimique, analyse métallographique
- Test charge d'essai (WLL x 2,5)
- Essai de traction
- Essai de fatigue (min. 20.000 cycles)

CERTIFICATS DISPONIBLES

- Spécification produit
- Rapport d'essai type 2.2 UNI EN10204
- Certificat de contrôle type 3.1 UNI EN10204
- Déclaration de Conformité CE

WLL	kg	Ø mm	A mm	B mm	CHF		
1600	7	110	60	13.30	1	080850215	
2120	8	110	60	18.90	1	080850220	
3150	10	135	75	26.50	1	080850232	
5300	13	160	90	46.50	1	080850253	
8000	16	180	100	93.50	1	080850280	
11200	19	200	110	152.00	1	080850311	
16000	20	260	140	250.00	1	080850316	
17000	22	300	160	355.00	1	080850317	

La charge de travail est relative à l'utilisation des élingues.
avec 1 bras. (*) Combiné avec une chaîne Ø 6, WLL= 1120 kg.

8086

Anneau de tête triple en acier allié, traitement thermique d'amélioration

CE



EN 1677-4

CARACTÉRISTIQUES TECHNIQUES

- coefficient de sécurité : 4
- traitement thermique : bonification
- code lot de fabrication

ANALYSES DE LABORATOIRE

- analyse chimique, analyse métallographique
- test charge d'essai (WLL x 2,5)
- essai de traction
- essai de fatigue (min. 20000 cycles)

CERTIFICATS DISPONIBLES

- Spécification produit
- Rapport d'essai type 2.2 UNI EN10204
- Certificat de contrôle type 3.1 UNI EN10204
- Déclaration de Conformité CE

WLL	kg	Ø mm	B mm	C mm	CHF		
3150	7	135	75	86.00	1	080860021	
4250	8	160	90	132.50	1	080860042	
6700	10	180	100	170.50	1	080860067	
11200	13	200	110	277.00	1	080860100	
17000	16	260	140	404.00	1	080860117	
21200	18	340	180	723.00	1	080860121	
26500	20	350	190	1,025.00	1	080860126	

La charge de travail se réfère à des slings 3 ou 4 bras et un angle β inférieur à 45°.

(*) Combiné avec une chaîne de Ø 6mm, WLL= 2360 kg

8090R

Maillon d'assemblage en acier allié, traitement thermique d'amélioration

CE

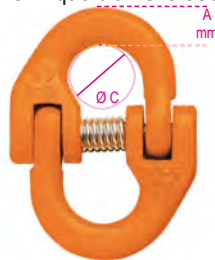

EN 1677-1

CARACTÉRISTIQUES TECHNIQUES

- coefficient de sécurité : 4
- traitement thermique : bonification
- code lot de fabrication

ANALYSES DE LABORATOIRE

- analyse chimique, analyse métallographique
- test charge d'essai (WLL x 2,5)
- essai de traction
- essai de fatigue (min. 20000 cycles)

CERTIFICATS DISPONIBLES

- Spécification produit
- Rapport d'essai type 2.2 UNI EN10204
- Certificat de contrôle type 3.1 UNI EN10204
- Déclaration de Conformité CE

WLL	kg	Ø mm	ØC max mm	A max mm	CHF		
1120	6	13	7,5	11.30	1	080900111	
1500	7	18	9	14.60	1	080900115	
2000	8	18	11	17.90	1	080900120	
3150	10	22	13,0	21.80	1	080900131	
5300	13	30	16	39.50	1	080900153	
8000	16	32	22	86.00	1	080900180	
12500	20	40	25	197.00	1	080900312	

8060R

Crochet à chape standard en acier allié, traitement thermique d'amélioration

CE



EN 1677-2

CARACTÉRISTIQUES TECHNIQUES

- coefficient de sécurité : 4
- traitement thermique : bonification
- code lot sur pivot, languette, corps

ANALYSES DE LABORATOIRE

- analyse chimique, analyse métallographique
- test charge d'essai (WLL x 2,5)
- essai de traction

- essai de fatigue (min. 20.000 cycles)

CERTIFICATS DISPONIBLES

- Spécification produit
- Rapport d'essai type 2.2 UNI EN10204
- Certificat de contrôle type 3.1 UNI EN10204
- Déclaration de Conformité CE

WLL	kg	Ø mm	C mm	CHF		
1120	6	19	21.20	1	080600111	
1500	7	19	22.70	1	080600115	
2000	8	21	23.70	1	080600120	
3150	10	27	41.00	1	080600132	
5300	13	35	65.00	1	080600153	
8000	16	48	207.00	1	080600180	
12500	20	54	368.00	1	080600225	

8058R

Crochet à verrouillage automatique à chape, acier allié, traitement thermique d'amélioration

CE



EN 1677-3

CARACTÉRISTIQUES TECHNIQUES

- coefficient de sécurité : 4
- traitement thermique : normalisation
- code lot de fabrication

ANALYSES DE LABORATOIRE

- analyse chimique, analyse métallographique
- essai de traction
- essai de fatigue (min. 20.000 cycles)

- test charge d'essai (100% du lot)

CERTIFICATS DISPONIBLES

- Spécification produit
- Rapport d'essai type 2.2 UNI EN10204
- Certificat de contrôle type 3.1 UNI EN10204
- Déclaration de Conformité CE

WLL	kg	Ø mm	J min mm	CHF		
1120	6	28	45.00	1	080580112	
2000	7-8	34	55.00	1	080580120	
3150	10	44	86.00	1	080580132	
5300	13	52	170.50	1	080580153	
8000	16	67	384.00	1	080580180	
12500	20	77	960.00	1	080580225	

8061R

Crochet parallèle à chape, avec sécurité de blocage, acier allié, traitement thermique d'amélioration

CE



EN 1677-1

CARACTÉRISTIQUES TECHNIQUES

- coefficient de sécurité: 4
- traitement thermique: normalisation
- code lot de fabrication
- ANALYSES DE LABORATOIRE
- analyse chimique, analyse métallographique
- essai de traction
- essai de fatigue (min. 20.000 cycles)
- test charge d'essai (100% du lot)
- CERTIFICATS DISPONIBLES
- Spécification produit
- Rapport d'essai type 2.2 UNI EN10204
- Certificat de contrôle type 3.1 UNI EN10204
- Déclaration de Conformité CE

WLL kg	Ø mm	E mm	CHF		
1120	6	8	15.80	1	080610211
2000	7-8	11	18.00	1	080610220
3150	10	13	33.00	1	080610231
5300	13	17	57.50	1	080610253
8000	16	20	129.50	1	080610280
12500	20	24	309.00	1	080610312

8052

Crochet de levage à œil pour câble, haute résistance en acier allié

CE



EN 1677-2

CARACTÉRISTIQUES TECHNIQUES

- coefficient de sécurité: 4
- traitement thermique: bonification
- code lot de fabrication
- ANALYSES DE LABORATOIRE
- analyse chimique, analyse métallographique
- essai de traction
- essai de fatigue (min. 20.000 cycles)
- test charge d'essai (WLL x 2)
- CERTIFICATS DISPONIBLES
- Spécification produit
- Rapport d'essai type 2.2 UNI EN10204
- Certificat de contrôle type 3.1 UNI EN10204
- Déclaration de Conformité CE

WLL kg	C mm	CHF		
8052	800	18	8.05	1 080520008
8052	1120	22,5	10.80	1 080520011
8052	2000	30	22.80	1 080520020
8052	3150	36	34.50	1 080520031
8052	4000	39,5	45.00	1 080520040
8055S	5400	32	88.00	1 080550145
8055S	8000	43	153.50	1 080550170
8055S	11500	53	306.00	1 080550215
8055S	16000	58	412.00	1 080550260
8055S	22000	78	965.00	1 080550320

8057R

Crochet à verrouillage automatique à œil, acier allié, traitement thermique d'amélioration

CE

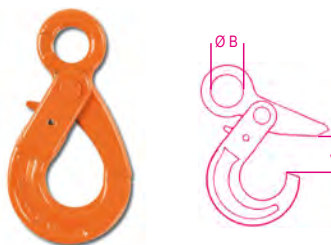

EN 1677-3

CARACTÉRISTIQUES TECHNIQUES

- coefficient de sécurité: 4
- traitement thermique: normalisation
- code lot de fabrication
- ANALYSES DE LABORATOIRE
- analyse chimique, analyse métallographique
- essai de traction
- essai de fatigue (min. 20.000 cycles)
- test charge d'essai (100% du lot)
- CERTIFICATS DISPONIBLES
- Spécification produit
- Rapport d'essai type 2.2 UNI EN10204
- Certificat de contrôle type 3.1 UNI EN10204
- Déclaration de Conformité CE

WLL kg	Ø mm	J min mm	ØB mm	CHF		
1120	6	28	22	36.50	1	080570112
2000	7-8	34	25	43.50	1	080570120
3150	10	44	32	78.00	1	080570132
5300	13	54	40	273.00	1	080570153

8063

Crochet de levage orientable (horse charge), acier allié, traitement thermique d'amélioration

CE



EN 1677-1

CARACTÉRISTIQUES TECHNIQUES

- coefficient de sécurité: 4
- traitement thermique: normalisation
- code lot de fabrication
- ANALYSES DE LABORATOIRE
- analyse chimique, analyse métallographique
- essai de traction
- essai de fatigue (min. 20.000 cycles)
- test charge d'essai (100% du lot)
- CERTIFICATS DISPONIBLES
- Spécification produit
- Rapport d'essai type 2.2 UNI EN10204
- Certificat de contrôle type 3.1 UNI EN10204
- Déclaration de Conformité CE

WLL kg	A mm	E mm	CHF		
800	32	20,5	18.00	1	080630008
1120	38	20,5	22.70	1	080630011
2000	44,5	22	27.50	1	080630020
3150	44,5	27	34.00	1	080630031

8063SL

crochets pivotants auto-bloquant (pas de sous charge) Alliage d'acier haute résistance Niveau 8

CE

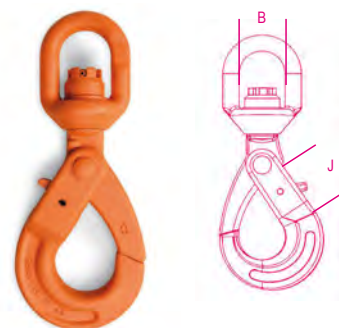

EN 1677-1

DONNÉES TECHNIQUES

- facteur de sécurité: 4
- traitement thermique: durcissement et revenu
- code de traçabilité TESTS DE LABORATOIRE
- analyse chimique, analyse métallographique
- essai de traction
- essai de fatigue (min. 20 000 cycles)
- test de charge (100% du lot) CERTIFICATS DISPONIBLES
- Spécifications techniques du produit
- Rapport d'essai UNI EN10204 type 2.2
- Certificat d'inspection UNI EN10204 type 3.1
- Déclaration de conformité CE

WLL kg	Ø mm	B mm	J mm	CHF		
1120	6	32	45	47.00	1	080630311
2000	8	35	59	65.50	1	080630320
3150	10	42	54	114.00	1	080630331
5300	13	49	83	174.00	1	080630353

8064S

Crochet à touret, en acier au carbone, traitement thermique d'amélioration

CE

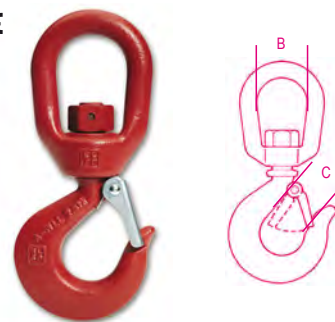

EN 1677-5

CARACTÉRISTIQUES TECHNIQUES

- coefficient de sécurité: 5
- traitement thermique: bonification
- code lot de fabrication
- ANALYSES DE LABORATOIRE
- analyse chimique, analyse métallographique
- test charge d'essai (WLL x 2,5)
- essai de traction
- essai de fatigue (min. 20000 cycles)
- CERTIFICATS DISPONIBLES
- Spécification produit
- Rapport d'essai type 2.2 UNI EN10204
- Certificat de contrôle type 3.1 UNI EN10204
- Déclaration de Conformité CE

WLL kg	B mm	C mm	CHF		
800	31	20	44.00	1	080640107
1000	40	22	62.00	1	080640110
1600	47	23	81.00	1	080640115
2000	47	27	88.50	1	080640120
3200	64	35	155.00	1	080640130
5000	77	43	283.00	1	080640150
7500	90	53	413.00	1	080640175
10000	96	58	686.00	1	080640199

8065SC

Crochet à touret pivotant sous charge en acier au carbone, traitement thermique d'amélioration

CE



EN 1677-5

CARACTÉRISTIQUES TECHNIQUES

- coefficient de sécurité : 5
- traitement thermique : bonification
- code lot de fabrication
- ANALYSES DE LABORATOIRE
- analyse chimique, analyse métallographique
- test charge d'essai (WLL x 2,5)
- essai de traction
- essai de fatigue (min. 20000 cycles)
- CERTIFICATS DISPONIBLES
- Spécification produit
- Rapport d'essai type 2.2 UNI EN10204
- Certificat de contrôle type 3.1 UNI EN10204
- Déclaration de Conformité CE

WLL kg	B mm	C mm	CHF	📦	🚚
800	38	20	88.00	1	080650107
1000	38	22	96.00	1	080650110
1600	47	23	119.00	1	080650115
2000	47	27	135.50	1	080650120
3200	54	35	238.50	1	080650130
5000	72	43	353.00	1	080650150
7500	82	53	599.00	1	080650175

8062

Crochet coulissant en acier allié

CE

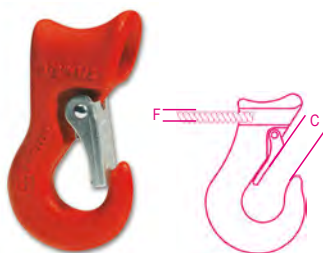

CARACTÉRISTIQUES TECHNIQUES

- coefficient de sécurité : 5
- traitement thermique: bonification
- code lot de fabrication
- ANALYSES DE LABORATOIRE
- analyse chimique, analyse métallographique
- test charge d'essai (WLL x 2,5)
- essai de traction
- CERTIFICATS DISPONIBLES
- Spécification produit
- Rapport d'essai type 2.2 UNI EN10204
- Certificat de contrôle type 3.1 UNI EN10204
- Déclaration de Conformité CE

WLL kg	C mm	F mm	CHF	📦	🚚
1500	19	10-13	53.50	1	080620013
2000	21	16	75.00	1	080620016
3000	26	18	125.00	1	080620018
5000	34	22-25	167.50	1	080620025

8051S

Crochet à œil avec sûreté de blocage, zingué, acier au carbone

CE



GRADO 4

CARACTÉRISTIQUES TECHNIQUES

- coefficient de sécurité : 4
- traitement thermique : normalisation
- code lot de fabrication
- ANALYSES DE LABORATOIRE
- analyse chimique
- analyse métallographique
- essai de traction
- CERTIFICATS DISPONIBLES
- Spécification produit
- Rapport d'essai type 2.2 UNI EN10204
- Certificat de contrôle type 3.1 UNI EN10204
- Déclaration de Conformité CE

WLL kg	C mm	F mm	CHF	📦	🚚
250	14	12	3.90	10	080510202
500	18	16,5	8.60	5	080510205

formats de vente spéciaux pour libre service



WLL kg	📦	CHF	🚚
250	1	5.50	1
500	1	10.70	1

8135

Pinces de levage pour plaque d'acier équipées d'œillets de levage articulés

CE



EN13155

DONNÉES TECHNIQUES

- Facteur de sécurité: 3
- Plaque d'identification du numéro de série
- CERTIFICATS DISPONIBLES
- Certificat du fabricant
- Déclaration de conformité CE
- Rapport d'essai UNI EN10204 type 2.2
- Spécifications techniques du produit

WLL t	A mm	📦 kg	CHF	📦	🚚
0,75	0-15	2	160.00	1	081350005
1,0	0-20	5	216.50	1	081350010
2,0	0-25	8	321.00	1	081350020
3,0	0-30	15	544.00	1	081350032
5,0	0-50	23	766.00	1	081350050

8143

Palans manuels à chaîne

CE



EN13157

WLL t	L m	H mm	sforzo / effort kg	CHF	📦	🚚
0,5	3	285	27	259.00	1	081430005
1	3	315	44	305.00	1	081430010
2	3	380	44	443.00	1	081430020
3	3	475	45	570.00	1	081430030
5	3	600	47	848.00	1	081430050

0,5	6	285	27	387.00	1	081430105
1	6	315	44	435.00	1	081430110
2	6	380	44	614.00	1	081430120
3	6	475	45	877.00	1	081430130
5	6	600	47	1,245.00	1	081430150

Robur

8146

Palans à levier

CE



H

EN13157

WLL	t	L min	H	mm	mm	sfuerzo / effort	kg	CHF		
0,75	1,5	320	21*					315.00	1	081460008
1,5	1,5	380	41*					449.00	1	081460015
3,0	1,5	480	41					600.00	1	081460030
6,0	1,5	600	46					975.00	1	081460060

0,75	3,0	320	21*					353.00	1	081460108
1,5	3,0	380	41*					498.00	1	081460115
3,0	3,0	480	41					688.00	1	081460130
6,0	3,0	600	46					1,169.00	1	081460160

H= distance minimale entre les crochets
(*) dotée de système de protection contre le surcharge



8146C

Palans à levier compact

CE



H

EN13157

WLL	t	L min	H	mm	mm	sfuerzo / effort	kg	CHF		
0,25	1,5	230	20,7					290.00	1	081460002

H= distance minimale entre les crochets

8149S/A

Sac à chaîne de levage,
en tissu noir



A	C	8143	8143	CHF		
mm	mm	t	L m			
100	250	0,5 - 1	3/6 - 3/6	27.00	1	081490510
120	350	2 - 3	3/6 - 3	29.50	1	081490512
150	450	3 - 5	6 - 3/6	32.00	1	081490515

8147C

Chariot de translation à chaîne pour palans manuels

Adapté aux poutres structurales INP, IPB, IPE, HEA, HEB, par exemple.

CE



EN 13157

Caractéristiques techniques :
• coefficient de sécurité : 4
• plaque d'identification du numéro de série

Certificats disponibles :
• certificat du fabricant
• Déclaration de Conformité CE
• Rapport d'essai type 2.2 UNI EN10204
• Spécifications techniques du produit

WLL	L min	L max	mm	mm	mm	CHF		
t	mm	mm	Lm					
1,0	58	220	3			322.00	1	081470510
2,0	66	220	3			413.00	1	081470520
3,0	74	220	3			631.00	1	081470530
5,0	90	220	3			870.00	1	081470550

Article livré démonté : il doit être assemblé avant utilisation conformément au mode d'emploi.

8147S

Chariot à pousser pour palans manuels

Adapté aux poutres structurales INP, IPB, IPE, HEA, HEB, par exemple.

CE



EN 13157

Caractéristiques techniques :
• coefficient de sécurité : 4
• plaque d'identification du numéro de série

Certificats disponibles :
• certificat du fabricant
• Déclaration de Conformité CE
• rapport d'essai type 2.2 UNI EN10204
• spécifications techniques du produit

WLL	L min	L max	mm	mm	mm	CHF		
t	mm	mm	mm					
0,5	50	220	25			207.50	1	081470005
1,0	58	220	30			266.00	1	081470010
2,0	66	220	40			339.00	1	081470020

Article livré démonté : il doit être assemblé avant utilisation conformément au mode d'emploi.



8147P

Pince d'ancrage pour palans manuels

Adaptée aux poutres structurales INP, IPB, IPE, HEA, HEB, par exemple.

CE

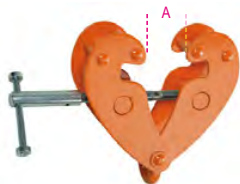

EN 13157

Caractéristiques techniques :

- Coefficient de sécurité : 4
- Plaque d'identification du numéro de série

Certificats disponibles :

- certificat du fabricant
- Déclaration de Conformité CE
- rapport d'essai type 2.2 UNI EN10204
- spécifications techniques du produit

WLL t	A min mm	A max mm	CHF		
1,0	90	180	137.00	1	081470210
2,0	90	190	165.50	1	081470220
3,0	85	280	280.00	1	081470230
5,0	85	280	408.00	1	081470250

8148

Treuil manuel à câble, corps en alliage d'aluminium avec levier de commande, câble et crochet

Léger et portable, le treuil manuel à câble Robur est conforme à la norme EN 13157, fabriqué avec des matériaux de haute qualité et adapté pour soulever, tracter, tendre et sécuriser des charges dans toutes les directions au moyen du levier de commande.

Habituellement utilisé en se servant d'une connexion à un point d'ancrage fixe, il permet une grande précision dans le positionnement de la charge et garantit un fonctionnement sûr dans toutes les directions : horizontale, verticale ou inclinée. Son design compact et pratique le rend facile à installer et à utiliser.

Le treuil manuel Robur permet d'utiliser des cordes sans limites de longueur et, après vérification de la structure de support, il est possible d'en augmenter la portée d'un facteur 2, 3, 4 ou plus, par le biais de rouleaux de renvoi et de crochets, conformément à la norme de référence.

CE



EN 13157

- Coefficient de sécurité : 4:1

WLL t	L m	A mm	CHF		
0,8	20	426	454.00	1	081480008
1,6	20	545	712.00	1	081480016
3,2	20	660	1,172.00	1	081480032
0,8	30	426	516.00	1	081480108
1,6	30	545	806.00	1	081480116
3,2	30	660	1,345.00	1	081480132



8148F

Câble métallique en acier galvanisé gainé en croix avec crochet haute résistance

CE



WLL t	L m	ØF	CHF		
0,8	20	8,3	126.00	1	081480520
1,6	20	11	199.00	1	081480521
3,2	20	16	387.00	1	081480523
0,8	30	8,3	178.50	1	081480530
1,6	30	11	279.00	1	081480531
3,2	30	16	536.00	1	081480533

8120

Chaîne type "Genovese" pour connexions statiques, galvanisée



CARACTÉRISTIQUES TECHNIQUES

- Coefficient de sécurité : 4
- CERTIFICATS DISPONIBLES
- Spécification produit
- Rapport d'essai type 2.2 UNI EN10204

Ø mm	nr	WFL kg	m	CHF		
1,5	10	8	150	244.00	1	081200015
1,6	12	15	150	254.00	1	081200016
2,2	14	25	75	149.00	1	081200022
2,7	16	40	75	184.00	1	081200027
3,0	17	55	75	203.50	1	081200030
3,4	18	100	60	207.00	1	081200034
3,8	19	110	50	200.00	1	081200038
4,4	20	200	40	185.50	1	081200044
4,8	21	250	30	176.50	1	081200048
5,5	22	300	25	176.50	1	081200055
5,8	23	310	25	200.00	1	081200058
6,5	24	400	25	227.00	1	081200065
7,0	25	450	25	277.00	1	081200070
7,5	26	550	20	246.50	1	081200075
* 8,0	27	600	25	357.00	1	081200080
* 9,0	28	800	25	449.00	1	081200090
* 10,0	30	1000	20	454.00	1	081200100
* 12,0	32	1400	15	481.00	1	081200120

Attention : produit NON destiné au levage

(*) emballées en ÉCHEVEAUX

8120B

Chaîne type "Genovese" pour connexions statiques, galvanisée



CARACTÉRISTIQUES TECHNIQUES

- coefficient de sécurité: 4
- CERTIFICATS DISPONIBLES
- Spécification produit
- Rapport d'essai type 2.2 UNI EN10204

Ø mm	nr	WFL kg	m	CHF		
1,5	10	8	200	304.00	1	081200315
1,6	12	15	200	321.00	1	081200316
2,2	14	25	100	189.50	1	081200322
2,7	16	40	100	243.00	1	081200327
3,0	17	55	75	202.50	1	081200330
3,4	18	100	100	322.00	1	081200334
3,8	19	110	75	286.00	1	081200338
4,4	20	200	50	221.50	1	081200344
4,8	21	250	50	286.00	1	081200348
5,5	22	300	40	274.00	1	081200355
5,8	23	310	30	234.50	1	081200358
6,5	24	400	30	267.00	1	081200365
7,0	25	450	25	270.00	1	081200370
7,5	26	550	25	298.00	1	081200375
8,0	27	600	15	229.50	1	081200380
9,0	28	800	15	271.00	1	081200390
10,0	30	1000	10	222.00	1	081200400
12,0	32	1400	8	257.00	1	081200420

Attention : produit NON destiné au levage

8120D

Chaines calibrées DIN766 galvanisé par électrolyse disponible dans n'importe quelle longueur sur demande (>30m)



TECHNIQUES

- facteur de sécurité: 4 CERTIFICATS DISPONIBLES
- Spécifications techniques du produit
- Rapport d'essai UNI EN10204 type 2.2

Ø mm	P mm	WFL kg	m	CHF		
4	16	200	30	152.50	1	081200640
5	18,5	320	30	215.00	1	081200650
6	18,5	400	30	326.00	1	081200660
7	22	630	30	392.00	1	081200670
8	24	800	30	518.00	1	081200680
10	28	1250	30	791.00	1	081200700

Chaines calibrées DIN766 galvanisé à chaud

Ø mm	P mm	WFL kg	m	CHF		
4	16	200	30	189.50	1	081200840
5	18,5	320	30	260.00	1	081200850
6	18,5	400	30	386.00	1	081200860
7	22	630	30	453.00	1	081200870
8	24	800	30	601.00	1	081200880
10	28	1250	30	910.00	1	081200900



8129

Chaîne de délimitation
en métal galvanisé verni blanc et rouge



∅ mm	m	CHF		
5	30	322.00	1	081290050

Attention : produit NON destiné au levage ou à l'ancrage

8074

Mousqueton, zingué

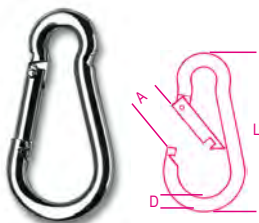

DIN 5299

CARACTÉRISTIQUES TECHNIQUES

- coefficient de sécurité : 4
- CERTIFICATS DISPONIBLES
- Spécification produit
- Rapport d'essai type 2.2 UNI EN10204

DxL mm	A mm	WFL kg	CHF		
* 4x40	6	20	0.80	100	080740040
5x50	7	30	0.81	100	080740050
6x60	8	40	0.90	100	080740060
7x70	9	60	1.15	50	080740070
8x80	11	75	1.38	50	080740080
9x90	12	100	1.88	25	080740090
10x100	13	120	2.53	25	080740100
11x120	16	140	3.45	20	080740101
12x140	22	140	4.80	15	080740102
13x160	24	200	6.60	10	080740103
* 14x180	32	250	13.80	5	080740104

8074A

Mousqueton avec anneau, zingué



DIN 5299

CARACTÉRISTIQUES TECHNIQUES

- coefficient de sécurité : 4
- CERTIFICATS DISPONIBLES
- Spécification produit
- Rapport d'essai type 2.2 UNI EN10204

∅AxL mm	D mm	WFL kg	CHF		
5x50	7,4	30	1.10	50	080740405
6x60	8,7	40	1.26	50	080740406
8x80	10,5	75	1.72	25	080740408
10x100	13,3	120	3.00	10	080740410

8074G

Mousqueton à vis, zingué

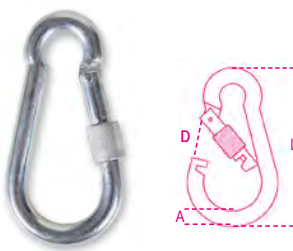

CARACTÉRISTIQUES TECHNIQUES

- coefficient de sécurité : 4
- CERTIFICATS DISPONIBLES
- Spécification produit
- Rapport d'essai type 2.2 UNI EN10204

∅AxL mm	D mm	WFL kg	CHF		
5x50	7,5	30	1.23	50	080740305
6x60	8,5	40	1.41	50	080740306
8x80	10,3	75	1.88	25	080740308
10x100	10,6	120	3.15	10	080740310

8080

Maillon rapide, zingué



CARACTÉRISTIQUES TECHNIQUES

- coefficient de sécurité : 4
- CERTIFICATS DISPONIBLES
- Spécification produit
- Rapport d'essai type 2.2 UNI EN10204

DxL mm	A mm	WFL kg	CHF		
3,5x36	5	20	0.65	100	080800003
4x40	6	30	0.70	100	080800004
5x49	6	50	0.85	100	080800005
6x57	8	60	1.06	100	080800006
7x66	8	100	1.38	50	080800007
8x74	11	140	1.64	50	080800008
9x80	11	160	2.36	25	080800009
10x89	11	220	2.77	25	080800010
12x105	15	300	4.80	20	080800012
14x125	16,5	400	10.30	3	080800014

8080FM

Câbles manquants/missing links,
galvanisés

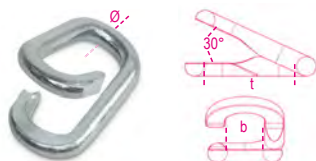

TECHNIQUES

- coefficient de sécurité: 4 CERTIFICATS DISPONIBLES
- Spécifications techniques du produit
- Rapport d'essai UNI EN10204 type 2.2

M	∅d mm	b mm	t mm	CHF		
4	3,8	8,6	21,5	0.51	100	080800204
5	4,7	11,1	25,8	0.84	50	080800205
6	5,3	13,8	32,0	1.62	30	080800206
7	6,5	16,8	37,0	1.93	10	080800207
8	8,0	18,0	38,0	2.83	10	080800208

8082

Œillet
acier galvanisé

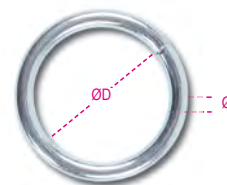

∅ mm	∅D mm	WFL kg	CHF		
4	20	75	0.50	50	080820004
5	30	125	0.65	20	080820005
6	40	185	1.06	10	080820006
7	50	265	1.64	5	080820007
8	60	350	2.20	5	080820008

8083

Crochet en "S"
acier galvanisé



∅ mm	L mm	WFL kg	CHF		
3	33	4	0.10	100	080830003
4	40	5	0.15	60	080830004
5	47	12	0.28	50	080830005
6	59	18	0.51	30	080830006
8	79	33	1.27	10	080830008

8114

Trous oblongs pivotant et galvanisés

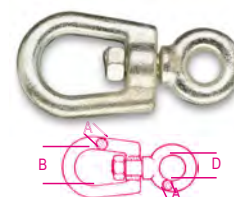

DONNEES TECHNIQUES :

- facteur de sécurité : 4
- codes de traçabilité
- TESTS EN LABORATOIRE
- Essais de traction
- CERTIFICATS DISPONIBLES
- Spécifications techniques du produit
- Rapport d'essai UNI EN10204 type 2.2
- Certificat d'inspection UNI EN10204 type 3.1

A mm	B mm	D mm	WFL kg	CHF		
8	30	16	250	5.20	10	081140008
10	38	18	300	9.60	10	081140010
12	42	20	650	13.90	5	081140012
14	48	22	820	21.60	5	081140014
16	57	24	1000	29.50	3	081140016
18	64	26	1600	35.50	3	081140018
20	72	30	2000	49.50	1	081140020
22	80	34	2500	69.50	1	081140022

8116

Emerillon à anneau double, zingué

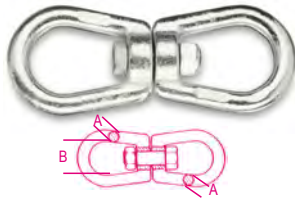

CARACTÉRISTIQUES TECHNIQUES

• coefficient de sécurité : 4

• code d'identification

ANALYSES DE LABORATOIRE

• essai de traction

CERTIFICATS DISPONIBLES

• Spécification produit

• Rapport d'essai type 2.2 UNI EN10204

A mm	B mm	WFL kg	CHF		
6	23	140	5.60	10	081160006
8	30	250	6.95	10	081160008
10	38	300	12.70	5	081160010
12	42	650	20.80	5	081160012
14	48	820	31.00	3	081160014
16	57	1000	39.00	3	081160016
18	64	1600	47.00	1	081160018
20	72	2000	67.00	1	081160020
22	80	2500	103.50	1	081160022

8317SZ

Serre-câble plat, 1 boulon, zingué



CERTIFICATS DISPONIBLES

• Rapport d'essai type 2.2 UNI EN10204

Ø mm	L mm	L1 mm	CHF		
2	15	14	0.31	100	083170102
3	18	16	0.33	100	083170103
4	20	19	0.46	100	083170104
5	24	23	0.53	50	083170105
6	30	27	0.62	30	083170106
8	36	34	1.20	20	083170108
10	42	37	1.79	10	083170110

8317DZ

Serre-câble plat, 2 boulons, zingué



CERTIFICATS DISPONIBLES

• Rapport d'essai type 2.2 UNI EN10204

Ø mm	L mm	L1 mm	CHF		
2	30	14	0.41	50	083170002
3	35	15	0.56	50	083170003
4	40	18	0.65	50	083170004
5	50	21	0.82	25	083170005
6	60	25	1.10	20	083170006
8	76	33	2.36	10	083170008
10	95	37	3.55	10	083170010

8381SL

Support pour radiateurs, série légère zingué

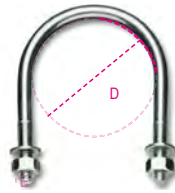

CERTIFICATS DISPONIBLES

• Spécification produit

• Rapport d'essai type 2.2 UNI EN10204

D mm	D gas	E mm	CHF		
11	1/8"	M6	0.65	100	083810201
14	1/4"	M6	0.70	100	083810202
18	3/8"	M6	0.70	100	083810203
22	1/2"	M6	0.80	100	083810204
27	3/4"	M6	0.80	100	083810205
34	1"	M6	0.87	100	083810206
43	1 1/4"	M6	0.87	100	083810207
49	1 1/2"	M8	1.55	50	083810208
61	2"	M8	1.64	50	083810209
77	2 1/2"	M8	1.95	25	083810210
89	3"	M8	2.09	25	083810211
102	3 1/2"	M8	2.36	25	083810212
115	4"	M8	2.61	25	083810213
140	5"	M8	5.70	25	083810215
168	6"	M10	6.20	25	083810218
220	8"	M10	12.70	10	083810220

8381SP

Support pour radiateurs série lourde zingué

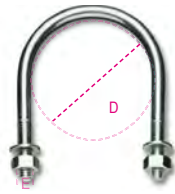

CERTIFICATS DISPONIBLES

• Spécification produit

• Rapport d'essai type 2.2 UNI EN10204

D mm	D gas	E mm	CHF		
22	1/2"	M8	1.15	100	083810301
27	3/4"	M8	1.24	100	083810302
34	1"	M8	1.34	100	083810303
43	1 1/4"	M8	1.46	100	083810304
49	1 1/2"	M10	2.46	25	083810305
61	2"	M10	2.68	25	083810306
77	2 1/2"	M10	3.10	25	083810307
89	3"	M10	3.25	25	083810308
102	3 1/2"	M12	5.20	25	083810309
115	4"	M12	5.70	15	083810310
140	5"	M12	8.85	15	083810312
168	6"	M16	14.90	15	083810315
220	8"	M16	26.00	10	083810320
274	10"	M16	27.50	1	083810374
274	10"	M20	39.50	1	083810375
324	12"	M20	84.50	1	083810386
408	16"	M24	124.00	1	083810508

8383C

Etrier fileté carré pour agriculture galvanisé à chaud

Écrous bridés

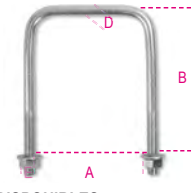

CERTIFICATS DISPONIBLES

• Spécification produit

• Rapport d'essai type 2.2 UNI EN10204

A mm	E mm	B mm	D mm	CHF		
70	M10	110	8,55	2.61	130	083830070
80	M10	120	8,55	3.00	110	083830080
90	M10	130	8,55	3.25	100	083830090
100	M10	155	8,55	3.90	90	083830100
120	M10	175	8,55	4.55	70	083830120

8383P

Plaque pour étriers filetés carrés galvanisé à chaud

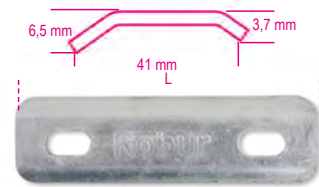

CERTIFICATS DISPONIBLES

• Spécification produit

• Rapport d'essai type 2.2 UNI EN10204

	L mm	CHF		
8383P 150	150	3.25	150	083830214
8383C/70-80				
/90-100				
8383P 170	170	3.90	120	083830217
8383C/100-120				

8515Z

Tire-fils pour agriculture zingué



D mm	H mm	L mm	CHF		
20	25	93	1.72	50	085150002
24,5	30	100	2.36	50	085150003

8515V

Tire-fils pour agriculture peint



D mm	H mm	L mm	CHF		
20	25	93	2.27	50	085150102
24,5	30	100	2.87	50	085150103



8515CH

Clé pour tendeurs de fils galvanisée



L mm	OA mm	OB mm	CHF		
90	8	7,5	0.82	20	085150901

8531

Manille type pêche zinguée à chaud

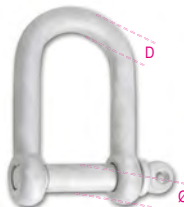

CERTIFICATS DISPONIBLES

• Rapport d'essai type 2.2 UNI EN10204

Ø mm	D mm	WFL kg	CHF		
20	18	1600	23.40	1	085310018
22	20	2500	34.00	1	085310020

8532

Manille type pêche, axe carré peint en noir



CERTIFICATS DISPONIBLES

• Rapport d'essai type 2.2 UNI EN10204

Ø mm	D mm	WFL kg	CHF		
20	20	1600	11.50	1	085320020
22	22	2500	17.60	1	085320022

8535

Crochet type pêche zingué

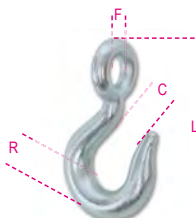

CERTIFICATS DISPONIBLES

• Rapport d'essai type 2.2 UNI EN10204

R mm	C mm	F mm	L mm	CHF	
26	27,5	34	156	26.00	1 085350006
30	36,5	40	185	36.00	1 085350007

8130

Chaîne antivol en acier allié, cimentée et normalisée, galvanisée



Ø mm	L mm	CHF		
6	800	19.50	1	081300068
8	1000	42.00	1	081300081
8	1200	47.50	1	081300082
10	1500	73.00	1	081300105

8130A

Chaîne antivol avec anneau en acier allié, trempé et normalisé, galvanisé



Ø mm	L mm	CHF		
10	900	68.00	1	081300209

8131Z

Chaîne antivol avec cadenas



Ø mm	L mm	8139Z Ø mm	CHF		
6	800	8	101.00	1	081310060

8131DL

Blocage-disque avec chaîne antivol 8130A



Ø mm	L mm	CHF		
10	900	155.50	1	081310209

8139DL

Cadenas bloque-disque moto, acier trempé, PVC antichoc emballé dans blister

- Fourni avec 3 clés, câble de signalisation, étui
- Adapté à chaînes 10 mm



Ø mm	L mm	H mm	CHF		
14	108	56	87.50	1	081390214

8139Z

Cadenas pour chaînes antivol, corps en alliage de zinc

- Fournis avec 3 clés mappées
- Adaptés aux chaînes de 6, 8, 10 mm



Ø mm	L mm	H mm	CHF		
8	45	90	82.00	1	081390008

8139ZCH

3 clés de rechange neutres pour cadenas 8139Z



CHF		
27.50	1	081390909

adatte per lucchetti ø8 e ø10

8050 D1÷D45

Kit cran de sécurité et pièces de rechange pour crochets de levage



	CHF		
8050D1 8064S-8065SC/800 8055S/1250	10.20	1	080500945
8050D2 8064S-8065SC/1000-8062/1500- 8055S/1600	11.90	1	080500946
8050D3 8064S-8065SC/1600-2000 8055S/2500-3200	12.80	1	080500947
8050D4 8064S-8065SC/3200 8055S/5400	21.20	1	080500948
8050D5 8064S-8065SC/5000 8055S/8000	24.60	1	080500949

8050D6	39.00	1	080500950
8064S/7500			
8055S/11500			
8050D11	20.20	1	080500955
8062/2000			
8050D12	22.30	1	080500956
8062/3000			
8050D13	40.50	1	080500957
8062/5000			
8050D22	53.50	1	080500966
8064S/10000			
8055S/16000			
8050D23	73.50	1	080500967
8055S/22000			
8050D24	0.93	1	080500969
8051S/250			
8050D25	1.11	1	080500970
8051S/500			
8050D30	29.50	1	080500975
8061F/8000			
8050D32	41.00	1	080500977
8060/8000			
8050D33	4.10	1	080500978
8052/800			
8050D34	4.60	1	080500979
8052/1120			
8050D35	5.65	1	080500980
8052/2000			
8050D36	6.15	1	080500981
8052/3150			
8050D37	7.25	1	080500982
8052/4000			
8050D38	2.67	1	080500983
8060R/1120			
8050D53	3.65	1	080500994
8060R/1500			
8050D39	3.65	1	080500984
8060R/2000			
8050D40	6.35	1	080500985
8060R/3150			
8050D41	9.75	1	080500986
8060R/5300			
8050D42	0.93	1	080500987
8063/800			
8050D43	1.33	1	080500988
8063/1120			
8050D44	1.73	1	080500989
8063/2000			
8050D45	2.13	1	080500990
8063/3150			



8050D46	2.77	1	080500991
8061R/1120			
8050D47	2.77	1	080500992
8061R/2000			
8050D48	3.80	1	080500993
8061R/3150			
8050D54	3.80	1	080500995
8061R/5300			



8050 D49	7.65	1	080500849
8057R - 8058R - 8063SL /1120			
8050 D50	8.30	1	080500850
8057R - 8058R - 8063SL /2000			
8050 D51	9.05	1	080500851
8057R - 8058R - 8063SL /3150			
8050 D52	20.30	1	080500852
8057R - 8058R - 8063SL /5300			

8058R/PS

Kit embouts et goupilles pour crochets 8058R-8061R



	Ø mm	CHF		
8058R/PS	6	8.85	1	080580512
8058R/PS	7-8	10.20	1	080580520
8058R/PS	10	20.30	1	080580532
8058R/PS	13	34.50	1	080580553

8060R/PS

Kit embouts et goupilles pour crochets 8060R



	Ø mm	CHF		
8060R/PS	6	8.85	1	080600511
8060R/PS	7	10.20	1	080600515
8060R/PS	8	10.20	1	080600520
8060R/PS	10	20.30	1	080600532
8060R/PS	13	34.50	1	080600553

8135/KLA1

Kit de leviers de commande pour pinces de levage 8135



8135 t	CHF		
0,75	19.70	1	081350605
1,00	24.40	1	081350610
2,00	28.00	1	081350615
3,00	34.00	1	081350620
5,00	52.50	1	081350625

La responsabilité des réparations incombe au réparateur.

8135/KCA

Kit de cames pour pinces de levage 8135



8135 t	CHF		
0,75	16.50	1	081350630
1,00	18.60	1	081350635
2,00	23.90	1	081350640
3,00	29.50	1	081350645
5,00	39.00	1	081350650

La responsabilité des réparations incombe au réparateur.

8135/KM0

Kit de ressorts pour pinces de levage 8135



8135 t	CHF		
0,75	8.75	1	081350655
1,00	12.70	1	081350660
2,00	16.60	1	081350665
3,00	21.30	1	081350670
5,00	31.50	1	081350675

La responsabilité des réparations incombe au réparateur.

8135/KGF

kit de mors fixe

La responsabilité des réparations incombe au réparateur.



8135 t	CHF		
0,75	29.00	1	081350705
1,00	51.00	1	081350710
2,00	61.50	1	081350720
3,00	80.00	1	081350730
5,00	95.50	1	081350750

8135/KGM

kit de mâchoires mobiles

La responsabilité des réparations incombe au réparateur.



8135 t	CHF		
0,75	96.50	1	081350805
1,00	156.00	1	081350810
2,00	200.00	1	081350820
3,00	294.00	1	081350830
5,00	423.00	1	081350850

8143/RKL

Kit de languettes crochet supérieur et inférieur pour palans manuels à chaîne 8143



8143 WLL t	CHF		
0,5	1.78	1	081430500
1,0	2.05	1	081430501
2,0	3.10	1	081430502
3,0	3.60	1	081430503
5,0	4.20	1	081430504

8143/RPC

Kit de goupilles de blocage de chaîne sur crochet pour palans à chaîne 8143



8143 WLL t	CHF		
0,5	2.13	1	081430510
1,0	2.91	1	081430511
2,0	3.15	1	081430512
3,0	5.15	1	081430513
5,0	5.60	1	081430514

 Robur

8143/RPF

Kit de goupilles de fin de course pour palans à chaîne 8143



8143 WLL t	CHF		
0,5	0.97	1	081430520
1,0	1.03	1	081430521
2,0	1.44	1	081430522
3,0	1.15	1	081430523
5,0	1.78	1	081430524

8143/RKCI

Kit de corps crochets inférieurs pour palans à chaîne 8143



8143 WLL t	CHF		
0,5	13.60	1	081430560
1,0	18.00	1	081430561
2,0	33.50	1	081430562
3,0	109.50	1	081430563
5,0	151.00	1	081430564

8146/RK

Jeu de crans de sécurité, embouts, fins de course pour palans manuels à LEVIER 8146C-8146



8146C-8146 WLL t	CHF		
0,25	6.80	1	081460902

8146/RKL

Kit de languettes crochet supérieur et inférieur pour palans manuels à levier 8146



8146 WLL t	CHF		
0,75	2.05	1	081460500
1,5	2.35	1	081460501
3,0	3.60	1	081460502
6,0	4.10	1	081460503

8146/RPC

Kit de goupilles de blocage de chaîne sur crochet pour palans manuels à levier 8146



8146 WLL t	CHF		
0,75	2.13	1	081460510
1,5	3.15	1	081460511
3,0	3.30	1	081460512
6,0	3.30	1	081460513

8146/RKFC

Kit de goupilles de fin de course pour palans manuels à levier 8146



8146 WLL t	CHF		
0,75	5.65	1	081460520
1,5	7.20	1	081460521
3,0	7.70	1	081460522
6,0	9.05	1	081460523

8146/RKCI

Kit de corps crochets inférieurs pour palans manuels à levier 8146



8146 WLL t	CHF		
0,75	15.60	1	081460560
1,5	33.50	1	081460561
3,0	109.50	1	081460562
6,0	207.50	1	081460563

8148/RA

Croix pour treuils manuels 8148



8148 t	CHF		
0,8	24.90	1	081480900
1,6	33.50	1	081480901
3,2	43.50	1	081480902

8148/RKS

Jeu de 3 épingles de sécurité de la surcharge pour treuils manuels 8148



8148 t	CHF		
0,8	4.60	1	081480903
1,6 - 3,2	5.75	1	081480904

8148/RKCM

Jeu de 2 capuchons de branche pour treuils manuels 8148



8148/RKCM	CHF		
	2.09	1	081480905

8148/RKCL

Jeu de 2 capuchons levier pour treuils manuels 8148



8148/RKCL	CHF		
	2.22	1	081480906

8148/RP

Embout de fixation pour treuils manuels 8148



8148 t	CHF		
0,8	19.10	1	081480907
1,6	25.50	1	081480908
3,2	32.00	1	081480909

8148/RKG

Jeu de 2 gaines de protection treuils manuels 8148



8148 t	CHF		
0,8	19.70	1	081480910
1,6	22.50	1	081480911
3,2	23.70	1	081480912

8149

chaînes pour palans

CE

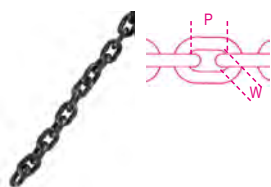

EN 818-7

CARACTÉRISTIQUES TECHNIQUES

- coefficient de sécurité : 4
- traitement thermique : bonification
- code lot de fabrication

ANALYSES DE LABORATOIRE

- analyse chimique
- analyse métallographique
- essai de traction

CERTIFICATS DISPONIBLES

- Spécification produit
- Rapport d'essai type 2.2 UNI EN10204
- Déclaration de Conformité CE

Ø mm	WLL Kg	P mm	W min	CHF/m		
4	500	12	4,8	18.90	1	081490012
5	800	15	6,0	23.20	1	081490015
6	1100	18	7,2	26.00	1	081490018
6,3	1200	19	7,6	29.00	1	081490019
8	2000	24	9,6	39.00	1	081490024
10	3200	30	12	60.50	1	081490030

8149CM

chaînes manuelles pour palans 8143



Ø mm	B mm	t mm	CHF/m		
4,8	8,2	22,2	6.00	1	081490901

* ATTENTION: Le produit est livré dans une longueur de chaîne, sauf indication contraire dans l'ordre!

8149CM/RA

Anneau soudé pour palans manuels à chaîne 8143



L m	Ø mm	B mm	CHF		
3	4,8	8,2	76.00	1	081490903
6	4,8	8,2	115.50	1	081490906

*Anneau fermé soudé. Lire attentivement le manuel de remplacement de la chaîne.



Résistance à la traction (BF) indiquée dans les notes techniques en ligne WWW.ROBURITALY.COM

8205

Tendeur à deux œillets
AISI 316

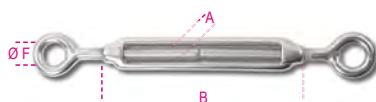

ANALYSES DE LABORATOIRE

- analyse chimique
 - essai de traction
- CERTIFICATS DISPONIBLES
- Spécification produit
 - Rapport d'essai type 2.2 UNI EN10204

A mm	B mm	ØF mm	WFL kg	CHF		
M4	62	8	75	7.65	10	082050204
M5	72	11	115	9.10	10	082050205
M6	92	12	160	12.10	8	082050206
M8	122	14	300	18.60	8	082050208
M10	150	16	470	28.00	4	082050210
M12	201	18	690	47.50	1	082050212
M14	225	22	940	119.00	1	082050214
M16	244	26	1290	121.50	1	082050216
M20	295	29	2130	175.50	1	082050220
M24	350	33	3000	402.00	1	082050224

8206

Tendeur œillets et crochet
AISI 316

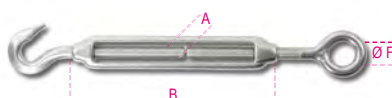

ANALYSES DE LABORATOIRE

- analyse chimique
 - essai de traction
- CERTIFICATS DISPONIBLES
- Spécification produit
 - Rapport d'essai type 2.2 UNI EN10204

A mm	B mm	ØF mm	WFL kg	CHF		
M5	72	11	25	9.25	10	082060205
M6	92	12	45	12.80	5	082060206
M8	122	14	95	19.50	5	082060208
M10	150	16	140	29.50	1	082060210
M12	201	18	300	49.50	1	082060212
M14	225	22	420	119.50	1	082060214
M16	244	26	570	122.00	1	082060216
M20	295	29	875	178.50	1	082060220

8207

Tendeur à deux crochets
AISI 316

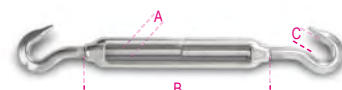

ANALYSES DE LABORATOIRE

- analyse chimique
 - essai de traction
- CERTIFICATS DISPONIBLES
- Spécification produit
 - Rapport d'essai type 2.2 UNI EN10204

A mm	B mm	C mm	WFL kg	CHF		
M5	72	9	25	9.80	10	082070205
M6	92	9	45	12.90	5	082070206
M8	122	10	95	19.80	5	082070208
M10	150	12	140	30.00	1	082070210
M12	201	14	300	50.00	1	082070212
M14	225	15	420	121.50	1	082070214
M16	244	16	570	126.00	1	082070216
M20	295	19	875	184.50	1	082070220

8209

Tendeur à deux chapes
AISI 316

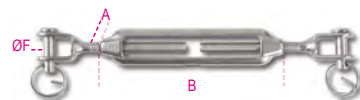

ANALYSES DE LABORATOIRE

- analyse chimique
 - essai de traction
- CERTIFICATS DISPONIBLES
- Spécification produit
 - Rapport d'essai type 2.2 UNI EN10204

A mm	B mm	ØF mm	WFL kg	CHF		
M5	72	5	115	16.40	5	082090205
M6	92	6	160	19.20	5	082090206
M8	122	8	300	27.50	5	082090208
M10	150	10	470	45.00	1	082090210
M12	201	12	690	73.00	1	082090212
M14	225	14	940	98.50	1	082090214
M16	244	16	1290	149.00	1	082090216
M20	295	20	2130	262.00	1	082090220
M24	350	24	3060	635.00	1	082090224

8210

Ridoir à deux chapes
AISI 316

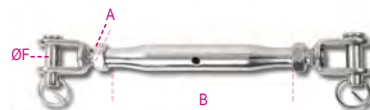

ANALYSES DE LABORATOIRE

- analyse chimique
 - essai de traction
- CERTIFICATS DISPONIBLES
- Spécification produit
 - Rapport d'essai type 2.2 UNI EN10204

A mm	B mm	ØF mm	WFL kg	CHF		
M5	81	5	115	20.60	3	082100205
M6	92	6	160	24.80	3	082100206
M8	112	8	300	36.00	1	082100208
M10	121	10	470	56.50	1	082100210
M12	150	12	690	93.50	1	082100212
M14	169	14	940	121.50	1	082100214
M16	190	16	1290	180.00	1	082100216
M20	220	20	2130	312.00	1	082100220

8210FTP

Tendeur à fourche et cosses à sertir
cage en tube
acier inoxydable AISI 316

Acier au Nickel, Chrome et Molybdène pour une plus grande résistance à la corrosion.

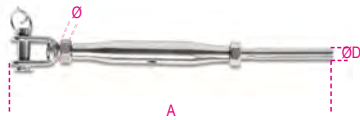

ANALYSES DE LABORATOIRE

- Analyse chimique
 - Essai de traction
- CERTIFICATS DISPONIBLES**
- Spécifications techniques du produit
 - Rapport d'essai type 2.2 UNI EN10204

Ø mm	A mm	ØD mm	WFL kg	CHF		
M5	159	2,70	150	22.90	2	082100605
M6	179	3,30	250	27.00	2	082100606
M8	216	4,30	350	37.00	1	082100608
M10	241	5,30	550	57.00	1	082100610
M12	300	6,30	1000	83.00	1	082100612
M14	345	7,30	1350	126.00	1	082100614
M16	383	8,30	1625	183.00	1	082100616
M20	484	10,50	2125	311.00	1	082100620

8201T

Cage en tube
AISI 316



ANALYSES DE LABORATOIRE

- analyse chimique
 - essai de traction
- CERTIFICATS DISPONIBLES**
- Spécification produit
 - Rapport d'essai type 2.2 UNI EN10204

Ø mm	Ø "	WFL kg	L mm	CHF		
M6	1/4	160	95	4.60	5	082010406
M8	5/16	300	105	6.75	5	082010408
M10	3/8	470	125	11.40	3	082010410
M12	1/2	690	150	19.80	3	082010412
M14	9/16	940	165	21.10	1	082010414
M16	5/8	1290	190	36.00	1	082010416
M20	3/4	2130	210	54.00	1	082010420

8210F

mâchoires à tendeurs,
acier inoxydable AISI 316

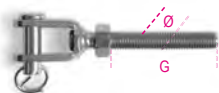

DE LABORATOIRE

- analyse chimique
 - essai de traction
- CERTIFICATS DISPONIBLES**
- Spécifications techniques du produit
 - Rapport d'essai UNI EN10204 type 2.2

Ø mm	Ø "	G mm	WFL kg	CHF		
M5	3/16	38,5	115	6.80	4	082100305
M6	1/4	49	160	7.65	4	082100306
M8	5/16	56	300	11.10	4	082100308
M10	3/8	61	470	19.00	2	082100310
M12	1/2	81	690	30.00	2	082100312
M14	9/16	93	940	47.00	2	082100314

chape pour tendeur à droite - zinguée

Ø mm	Ø "	G mm	WFL kg	CHF		
M5	3/16	38,5	115	6.80	4	082100405
M6	1/4	49	160	7.65	4	082100406
M8	5/16	56	300	11.10	4	082100408
M10	3/8	61	470	19.00	2	082100410
M12	1/2	81	690	30.00	2	082100412
M14	9/16	93	940	47.00	2	082100414

8248

Chape mâle
acier inoxydable 316L
filetage à droite



UNI 6058

CERTIFICATS DISPONIBLES

- Spécification produit
- Rapport d'essai type 2.2 UNI EN10204

ØxL mm	F mm	CHF		
8X120	6	8.85	1	082480008
10x80	8	12.00	1	082480010
10x130	8	16.00	1	082480012
12x95	10	18.10	1	082480016
12x125	10	21.60	1	082480018

8249

Vis à œil pour chevilles
AISI 316



ANALYSES DE LABORATOIRE

- analyse chimique
 - essai de traction
- CERTIFICATS DISPONIBLES**
- Spécification produit
 - Rapport d'essai type 2.2 UNI EN10204

A mm	ØB mm	D mm	WFL kg	CHF		
M5	11	50	100	3.30	10	082490205
M6	13	55	160	4.15	10	082490206
M8	17	60	300	6.70	5	082490208
M10	21	80	470	12.00	5	082490210
M12	25	120	690	20.80	2	082490212

8249G

Crochet pour chevilles
AISI 316

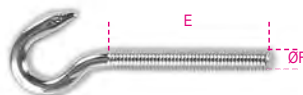

ANALYSES DE LABORATOIRE

- analyse chimique
 - essai de traction
- CERTIFICATS DISPONIBLES**
- Spécification produit
 - Rapport d'essai type 2.2 UNI EN10204

A mm	E mm	ØF mm	WFL kg	CHF		
M5	39	9	25	1.59	5	082490305
M6	43	10,5	45	1.90	5	082490306
M8	57	14,5	95	3.30	3	082490308

8216

Serre-câble
AISI 316

CE

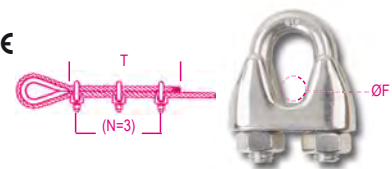

ANALYSES DE LABORATOIRE

- analyse chimique
 - essai de couple de serrage
- CERTIFICATS DISPONIBLES**
- Spécification produit
 - Rapport d'essai type 2.2 UNI EN10204
 - Certificat de Conformité CE

ØF mm	"	T	N	CHF		
2	5/64	80	3	3.85	20	082160202
3	1/8	80	3	3.90	20	082160203
4	5/32	80	3	4.40	20	082160204
5	3/16	110	3	4.95	20	082160205
6	1/4	120	5	5.60	10	082160206
8	5/16	210	5	7.40	10	082160208
10	3/8	240	5	10.30	8	082160210
12-13	1/2	300	5	14.30	5	082160213
16	5/8	335	5	21.10	5	082160216
20	3/4	540	5	26.50	5	082160220
22	7/8	595	7	42.50	3	082160222

formats de vente spéciaux pour libre service



ØF mm		CHF		
2	4	16.30	1	082169402
3	4	16.40	1	082169403
4	4	18.40	1	082169404
5	2	11.10	1	082169405
6	2	12.50	1	082169406
8	2	16.30	1	082169408
10	2	22.00	1	082169410

8220

Cosse-cœur
AISI 316

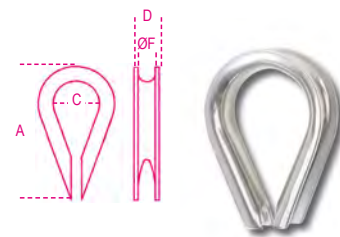

ANALYSES DE LABORATOIRE

- analyse chimique
 - essai de traction
- CERTIFICATS DISPONIBLES**
- Spécification produit
 - Rapport d'essai type 2.2 UNI EN10204

ØF mm	D mm	A mm	C mm	CHF		
2	4,5	21	7,5	1.26	15	082200202
3	6	24	10	1.38	15	082200203
4	6,6	28	11	1.59	10	082200204
5	8,5	30	13	1.90	10	082200205
6	10	37	15	2.16	10	082200206
8	12,5	51	23	3.40	5	082200208
10	14,6	56	27	4.15	5	082200210
12	18	68	32	5.70	5	082200212
14	19	69	34	7.40	5	082200214
16	22	83	37	8.30	5	082200216
18	23	81	38	9.80	1	082200218
20	27,8	105	45	11.50	1	082200220
22	29,6	112	45	15.00	1	082200222

8225

Manille droite
AISI 316



ANALYSES DE LABORATOIRE

- analyse chimique
- essai de traction

CERTIFICATS DISPONIBLES

- Spécification produit
- Rapport d'essai type 2.2 UNI EN10204

ø D mm	"	A mm	WFL kg	CHF		
4	5/32	8	50	4.05	20	082250204
5	3/16	11	70	4.45	20	082250205
6	1/4	13	100	4.85	10	082250206
8	5/16	17	250	7.90	10	082250208
10	3/8	21	400	11.40	8	082250210
12	1/2	25	600	18.60	3	082250212
16	5/8	32	1000	41.00	1	082250216
19	3/4	38	1600	68.00	1	082250219
22	7/8	43	2000	106.00	1	082250222
25	1	46	2800	155.00	1	082250225

8227

Manille droite longue
AISI 316



ANALYSES DE LABORATOIRE

- analyse chimique
- essai de traction

CERTIFICATS DISPONIBLES

- Spécification produit
- Rapport d'essai type 2.2 UNI EN10204

ø D mm	"	A mm	WFL kg	CHF		
4	5/32	8	50	3.40	10	082270204
5	3/16	10	70	3.90	10	082270205
6	1/4	13,5	100	4.95	5	082270206
8	5/16	17	250	8.15	5	082270208
10	3/8	21	400	13.40	2	082270210
12	1/2	25	600	21.20	1	082270212

8228

Manille lyre
AISI 316

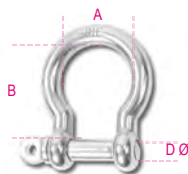

ANALYSES DE LABORATOIRE

- analyse chimique
- essai de traction

CERTIFICATS DISPONIBLES

- Spécification produit
- Rapport d'essai type 2.2 UNI EN10204

ø D mm	A mm	B mm	WFL kg	CHF		
4	13	20	60	3.10	10	082280204
5	17	23	80	3.55	10	082280205
6	20	27	100	4.05	10	082280206
8	28	36	200	6.45	5	082280208
10	36	44	300	10.30	5	082280210
12	41	53	500	16.50	5	082280212
16	54	74	800	36.00	1	082280216
19	66	86	1100	65.50	1	082280219

8240F

Anneau de levage mâle,
FORGÉ à chaud,
acier inoxydable A4

CE



CARACTÉRISTIQUES TECHNIQUES

- coefficient de sécurité : 6
- code lot de fabrication

ANALYSES DE LABORATOIRE

- analyse chimique
- analyse métallographique
- essai de traction

CERTIFICATS DISPONIBLES

- Spécification produit
- Rapport d'essai type 2.2 UNI EN10204
- Certificat de contrôle type 3.1 UNI EN10204
- Déclaration de Conformité CE

ø mm	WLL mm	WLL kg	CHF		
M6	1,0	120	9.25	4	082400406
* M8	1,25	200	10.30	4	082400408
* M10	1,5	400	17.40	4	082400410
* M12	1,75	600	28.00	4	082400412
* M14	2	1000	45.00	2	082400414
* M16	2	1200	45.00	2	082400416
* M20	2,5	2000	73.00	2	082400420
* M24	3	2700	138.00	2	082400424
* M30	3,5	4000	306.00	1	082400430

(*) WLLincrémenté par rapport à la norme DIN sur labase du Fascicule Technique R/FT/8240F (garantipour couplages inox-inox)

8240

Anneau mâle
AISI 316



ANALYSES DE LABORATOIRE

- analyse chimique
- essai de traction

CERTIFICATS DISPONIBLES

- Spécification produit
- Rapport d'essai type 2.2 UNI EN10204

A mm	B mm	ø C mm	WFL kg	CHF		
M6	41	15	90	2.66	10	082400206
M8	50	20	140	3.95	10	082400208
M10	62	25	230	7.95	5	082400210
M12	74	30	340	13.40	5	082400212

8242F

Anneau de levage femelle
FORGÉ à chaud,
acier inoxydable A4

CE



CARACTÉRISTIQUES TECHNIQUES

- coefficient de sécurité : 6
- code lot de fabrication

ANALYSES DE LABORATOIRE

- analyse chimique
- analyse métallographique
- essai de traction

CERTIFICATS DISPONIBLES

- Spécification produit
- Rapport d'essai type 2.2 UNI EN10204
- Certificat de contrôle type 3.1 UNI EN10204
- Déclaration de Conformité CE

ø mm	WLL mm	WLL kg	CHF		
M6	1,0	120	9.25	4	082420406
* M8	1,25	200	10.30	4	082420408
* M10	1,5	400	17.40	4	082420410
* M12	1,75	600	28.00	4	082420412
* M14	2	1000	45.00	2	082420414
* M16	2	1200	45.00	2	082420416
* M20	2,5	2000	73.00	2	082420420
* M24	3	2700	138.00	2	082420424
* M30	3,5	4000	306.00	1	082420430



8242

Anneau femelle
AISI 316



A	B	øC	WFL	CHF		
mm	mm	mm	kg			
M6	27	15	90	2.66	10	082420206
M8	36	20	140	3.95	10	082420208
M10	45	25	230	7.95	5	082420210
M12	55	30	340	13.40	5	082420212

8274

Mousqueton
AISI 316

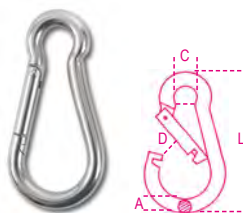

ANALYSES DE LABORATOIRE

- analyse chimique
- essai de traction

CERTIFICATS DISPONIBLES

- Spécification produit
- Rapport d'essai type 2.2 UNI EN10204

ø A x L	ø C	D	WFL	CHF		
mm	mm	mm	kg			
4,5x40	6,5	6	20	3.65	20	082740204
5x50	7	6,5	30	3.65	20	082740205
6x60	8,5	7,5	40	3.85	10	082740206
7x70	10	9	60	4.60	10	082740207
8x80	12	10	75	6.15	10	082740208
9x90	12,5	10,5	100	8.45	10	082740209
10x100	15	13	120	10.50	8	082740210
11x120	19	18	140	15.00	1	082740211
12x140	22	21	140	20.50	1	082740212
13x160	22	26	200	25.50	1	082740213

8274A

Mousqueton avec anneau AISI 316

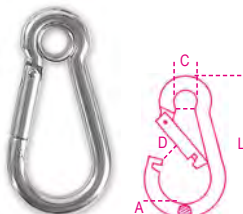

ANALYSES DE LABORATOIRE

- analyse chimique
- essai de traction

CERTIFICATS DISPONIBLES

- Spécification produit
- Rapport d'essai type 2.2 UNI EN10204

ø A x L	ø C	D	WFL	CHF		
mm	mm	mm	kg			
5x50	6,5	7	30	3.55	10	082740405
6x60	7,5	7,5	40	4.30	5	082740406
8x80	9,5	10	75	7.05	5	082740408

8274G

Mousqueton à vis AISI 316

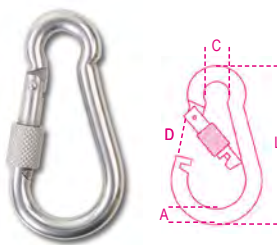

ANALYSES DE LABORATOIRE

- analyse chimique
- essai de traction

CERTIFICATS DISPONIBLES

- Spécification produit
- Rapport d'essai type 2.2 UNI EN10204

ø A x L	ø C	D	WFL	CHF		
mm	mm	mm	kg			
6x60	8,5	6,5	40	4.70	5	082740306
8x80	12	8,5	75	8.50	5	082740308
10x100	15	12	120	16.30	3	082740310

8276

Mousqueton asymétrique
AISI 316

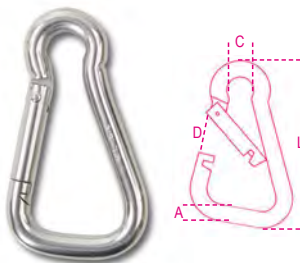

ANALYSES DE LABORATOIRE

- analyse chimique
- essai de traction

CERTIFICATS DISPONIBLES

- Spécification produit
- Rapport d'essai type 2.2 UNI EN10204

ø A x L	ø C	D	WFL	CHF		
mm	mm	mm	kg			
6x60	8,5	10	40	4.30	5	082760206
8x80	12	14	75	7.40	5	082760208
10x100	15	18	120	13.00	3	082760210

Robur

Robur

8276G

Mousqueton asymétrique à vis
AISI 316

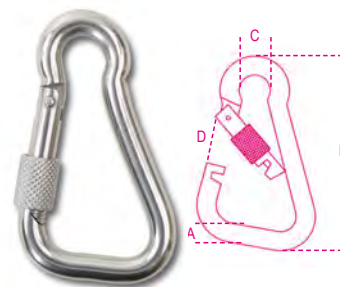

ANALYSES DE LABORATOIRE

- analyse chimique
- essai de traction

CERTIFICATS DISPONIBLES

- Spécification produit
- Rapport d'essai type 2.2 UNI EN10204

ø A x L	ø C	D	WFL	CHF		
mm	mm	mm	kg			
6x60	8,5	9	40	5.45	3	082760306
8x80	12	12,5	75	9.80	3	082760308
10x100	15	16	120	17.90	3	082760310

8278

Mousqueton trapézoïdal
AISI 316

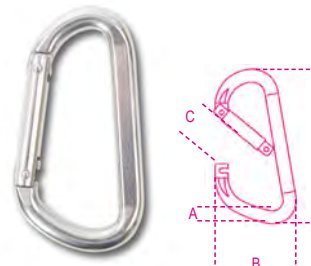

ANALYSES DE LABORATOIRE

- analyse chimique
- essai de traction

CERTIFICATS DISPONIBLES

- Spécification produit
- Rapport d'essai type 2.2 UNI EN10204

ø A x L	B	C	WFL	CHF		
mm	mm	mm	kg			
8x80	45	14	75	16.50	3	082780208
10x100	55	16	120	25.50	3	082780210

8280

Maillon rapide de jonction
AISI 316

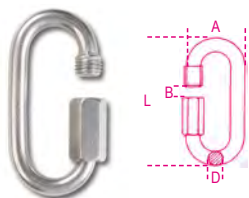

ANALYSES DE LABORATOIRE

- analyse chimique
 - essai de traction
- CERTIFICATS DISPONIBLES**
- Spécification produit
 - Rapport d'essai type 2.2 UNI EN10204

ø D x L mm	A mm	B mm	WFL mm	kg	CHF		
3,5x35	17	5	20		4.20	10	082800203
4x40	19	6	30		4.45	10	082800204
5x50	23	7	50		5.45	5	082800205
6x60	26	8	60		6.45	5	082800206
7x70	30	9	100		7.40	5	082800207
8x80	33	10	140		10.40	2	082800208
10x90	40	12	220		17.00	2	082800210
12x100	47	14	300		25.50	1	082800212

8250

Mousqueton crochet avec linguet
AISI 316



ANALYSES DE LABORATOIRE

- analyse chimique
 - essai de traction
- CERTIFICATS DISPONIBLES**
- Spécification produit
 - Rapport d'essai type 2.2 UNI EN10204

L mm	A mm	ø B mm	WFL mm	kg	CHF		
50	25	8	40		5.25	5	082500205
70	31	12,5	90		8.05	5	082500207
100	47	20	190		13.00	2	082500210

8264

Mousqueton à émerillon
AISI 316

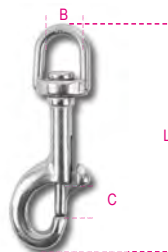

ANALYSES DE LABORATOIRE

- analyse chimique
 - essai de traction
- CERTIFICATS DISPONIBLES**
- Spécification produit
 - Rapport d'essai type 2.2 UNI EN10204

B mm	L mm	C mm	WFL mm	kg	CHF		
12	88	12	60		14.10	5	082640212
16	90	12	60		14.60	5	082640216
19	93	12	60		14.80	2	082640219

8267

Mousqueton à émerillon et œillet
AISI 316



ANALYSES DE LABORATOIRE

- analyse chimique
 - essai de traction
- CERTIFICATS DISPONIBLES**
- Spécification produit
 - Rapport d'essai type 2.2 UNI EN10204

A mm	L mm	B mm	WFL mm	kg	CHF		
10	87	21	30		12.50	5	082670210
12	118	22	70		21.00	2	082670213

8272

Emerillon à deux œillets
AISI 316

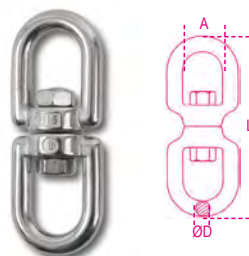

ANALYSES DE LABORATOIRE

- analyse chimique
 - essai de traction
- CERTIFICATS DISPONIBLES**
- Spécification produit
 - Rapport d'essai type 2.2 UNI EN10204

ø D mm	A mm	L mm	WFL mm	kg	CHF		
4	11	50	90		7.05	5	082720204
5	13	60	115		9.25	5	082720205
6	15	66	140		11.40	5	082720206
8	19	90	250		18.40	3	082720208
10	23	112	300		28.00	1	082720210
13	33	148	650		57.00	1	082720213
16	38	184	1000		106.50	1	082720216
19	40	223	1600		190.50	1	082720219

8273

Mousqueton à décrochage rapide
avec œillet pivotant
acier inox AISI 316



ANALYSES

- DE LABORATOIRE**
- analyse chimique
 - essai de traction
- CERTIFICATS DISPONIBLES**
- Spécification produit
 - Rapport d'essai type 2.2 UNI EN10204

ø C x L mm	B mm	WFL mm	BF mm	kg	CHF		
12x70	12	230	1100		21.60	1	082730012
16x85	14,50	440	2000		30.00	1	082730016
22x120	20	700	3500		47.00	1	082730022

8282S

Crochet en "S" symétrique,
acier inoxydable AISI 316

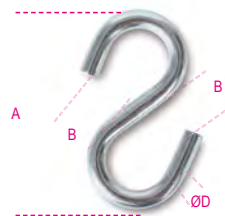

ANALYSES DE LABORATOIRE

- analyse chimique
 - essai de traction
- CERTIFICATS DISPONIBLES**
- Spécification produit
 - Rapport d'essai type 2.2 UNI EN10204

ø D mm	B mm	A mm	WFL mm	kg	CHF		
3	5,5	34	4		0.39	40	082820303
4	7,0	40	5		0.77	30	082820304
5	9,0	46	12		1.26	20	082820305
6	10	54	18		2.09	15	082820306

8284

Mousqueton crochet pélican
acier inox AISI 316



ANALYSES DE LABORATOIRE

- analyse chimique
 - essai de traction
- CERTIFICATS DISPONIBLES**
- Spécification produit
 - Rapport d'essai type 2.2 UNI EN10204

ø C mm	B mm	L mm	WFL mm	kg	CHF		
6	11	73	200		20.80	3	082840006
8	14	98	300		28.00	3	082840008
10	23	143	450		58.00	1	082840010

8285

Embout à sertir à chape
AISI 316

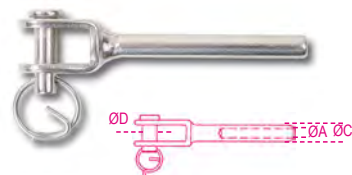

ANALYSES DE LABORATOIRE

- analyse chimique
 - essai de traction
- CERTIFICATS DISPONIBLES**
- Spécification produit
 - Rapport d'essai type 2.2 UNI EN10204

ø A M	ø C mm	ø D mm	WFL mm	kg	CHF		
3	6,3	6	180		4.15	5	082850203
4	7,5	8	200		6.70	3	082850204
5	9	10	330		9.10	2	082850205
6	12,5	12	720		19.00	2	082850206
7	12,5	12	850		20.30	2	082850207
8	15,5	16	1120		27.00	2	082850208
10	18	16	1300		38.50	2	082850210
12	20	19	2400		46.00	2	082850212

8286

Embout à sertir à œil
AISI 316



ANALYSES DE LABORATOIRE

- analyse chimique
 - essai de traction
- CERTIFICATS DISPONIBLES
- Spécification produit
 - Rapport d'essai type 2.2 UNI EN10204

Ø D	Ø A	Ø C	WFL	CHF		
M	mm	mm	kg			
3	6,5	6,3	180	4.30	5	082860203
4	8,5	7,5	200	4.95	3	082860204
5	10	9	330	6.70	2	082860205
6	12,5	12,6	720	11.00	2	082860206
7	12,5	14,2	850	11.90	2	082860207
8	14,5	16	1120	19.80	2	082860208
10	16,4	18	1300	34.50	2	082860210
12	19,3	20	2400	49.50	2	082860212

8287

Embout à sertir fileté
AISI 316



ANALYSES DE LABORATOIRE

- analyse chimique
 - essai de traction
- CERTIFICATS DISPONIBLES
- Spécification produit
 - Rapport d'essai type 2.2 UNI EN10204

Ø D	Ø A	E	WFL	CHF		
M	mm	mm	kg			
3	6,2	M6	180	3.70	5	082870203
4	7,5	M8	200	5.25	3	082870204
5	8,7	M10	330	7.40	2	082870205
6	12,6	M12	720	13.50	2	082870206
7	12,6	M14	850	18.90	2	082870207
8	16	M16	1120	27.00	2	082870208
10	18	M16	1300	30.00	2	082870210
12	20	M20	2400	41.50	2	082870212

8290

Pontet
AISI 316



ANALYSES DE LABORATOIRE

- analyse chimique
- CERTIFICATS DISPONIBLES
- Spécification produit
 - Rapport d'essai type 2.2 UNI EN10204

Ø A	B	Ø C	L	CHF		
mm	mm	mm	mm			
5	18	4,3	40	1.34	5	082900205
6	22	5,2	44	1.90	5	082900206
8	23	5,2	51	2.99	5	082900208

8381SX

Etrier fileté pour radiateurs

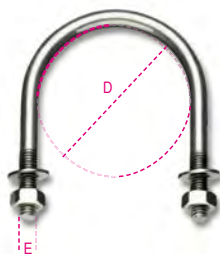

AISI 304

ANALYSES DE LABORATOIRE

- analyse chimique
- CERTIFICATS DISPONIBLES
- Rapport d'essai type 2.2 UNIEN10204

D	D	E	CHF		
mm	gas	mm			
11	1/8"	M6	3.30	20	083810401
14	1/4"	M6	3.40	20	083810402
18	3/8"	M6	3.50	20	083810403
22	1/2"	M6	3.55	20	083810404
27	3/4"	M6	3.65	20	083810405
34	1"	M6	3.85	20	083810406
43	1 1/4"	M6	4.40	20	083810407
49	1 1/2"	M8	7.90	10	083810408
61	2"	M8	8.70	10	083810409
77	2 1/2"	M8	10.00	10	083810410
89	3"	M8	11.10	10	083810412
115	4"	M8	14.30	10	083810413
168	6"	M10	27.00	1	083810416
220	8"	M10	33.00	1	083810418

8279

Chaîne type "Genovese"
pour connexions statiques,
acier inoxydable AISI 304



CARACTÉRISTIQUES TECHNIQUES

- Coefficient de sécurité : 4
- CERTIFICATS DISPONIBLES
- Spécification produit
 - Rapport d'essai type 2.2 UNI EN10204

Ø mm	nr	WFL	CHF		
		kg			
2	13	20 50	322.00	1	082790020
3	17	55 50	588.00	1	082790030
4	19	100 50	828.00	1	082790040
5	21	250 40	910.00	1	082790050
6	23	310 30	926.00	1	082790060
8	27	400 15	910.00	1	082790080
10	30	1000 10	1,425.00	1	082790400

Attention : produit NON destiné au levage

8293

Arrimage extérieur, 300 kg, AISI 304
boucle à rochet en polyester haute ténacité

dans sac pouvant être suspendu

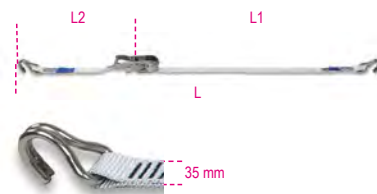

L	L2	L1	STF	CHF		
m	mm	mm	daN			
6	5700	300	100	92.50	1	082930106

LC = 300 kg

8297C

Arrimage extérieur sans-fin, 700 kg,
mini boucle à rochet AISI 304
en polyester haute ténacité

dans sac pouvant être suspendu

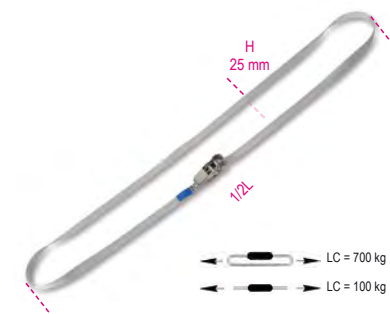

LC = 700 kg
LC = 100 kg

L	H	CHF		
m	mm			
5	25	40.50	1	082970350

8297F

Arrimage extérieur sans-fin, 250 kg,
boucle à came AISI 304
en polyester haute ténacité

dans sac pouvant être suspendu

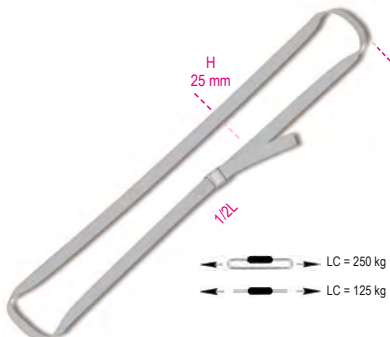

LC = 250 kg
LC = 125 kg

L	H	CHF		
m	mm			
3	25	40.50	1	082970230

LC = 250 kg



ÉLINGUE PLATE

coefficient 7:1

Certificat du Fabricant selon la norme UNI EN 149

CARACTÉRISTIQUES TECHNIQUES

- coefficient de sécurité : 7
- code lot de fabrication

ANALYSES DE LABORATOIRE

- essai de traction

CERTIFICATS DISPONIBLES

- Spécification produit
- Rapport d'essai type 2.2 UNI EN10204
- Certificat du Fabricant UNI EN1492
- Déclaration de Conformité CE

				$\beta = 0^\circ - 45^\circ$	$\beta = 45^\circ - 90^\circ$
	1t	0,8t	2t	1,4t	1t
	2t	1,6t	4t	2,8t	2t
	3t	2,4t	6t	4,2t	3t
	4t	3,2t	8t	5,6t	4t
	5t	4t	10t	7t	5t
	6t	4,8t	12t	8,4t	6t
	8t	6,4t	16t	11,2t	8t
	10t	8t	20t	14t	10t
	12t	9,6t	24t	16,8t	12t
	15t	12t	30t	21t	15t
	20t	16t	40t	28t	20t
	25t	20t	50t	35t	25t
	30t	24t	60t	42t	30t
	40t	32t	80t	56t	40t
	50t	40t	100t	70t	50t

8150

Élingue plate, 1t, violet, double couche, boutons renforcées, en polyester haute ténacité (PES)

CE



UNI EN 1492-1

L m	H mm	WLL ton	CHF		
0,5	30	1	6.80	1	081500005
1	30	1	8.60	1	081500010
1,5	30	1	11.10	1	081500015
2	30	1	12.30	1	081500020
2,5	30	1	14.00	1	081500025
3	30	1	15.60	1	081500030
3,5	30	1	17.40	1	081500035
4	30	1	20.10	1	081500040
5	30	1	23.60	1	081500050
6	30	1	27.00	1	081500060
8	30	1	35.50	1	081500080

Robur

8153

Élingue plate, 2t, vert, double couche, boutons renforcées, en polyester haute ténacité (PES)

CE

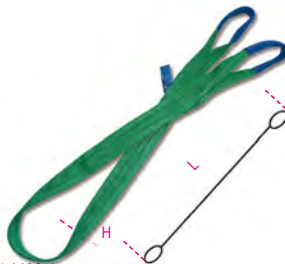

UNI EN 1492-1

L m	H mm	WLL ton	CHF		
1	60	2	13.60	1	081530010
1,5	60	2	18.40	1	081530015
2	60	2	21.10	1	081530020
2,5	60	2	24.80	1	081530025
3	60	2	28.50	1	081530030
3,5	60	2	33.50	1	081530035
4	60	2	35.50	1	081530040
5	60	2	43.50	1	081530050
6	60	2	51.00	1	081530060
8	60	2	65.00	1	081530080
10	60	2	78.50	1	081530100

8156

Élingue plate, 3t, jaune, double couche, boutons renforcées, en polyester haute ténacité (PES)

CE

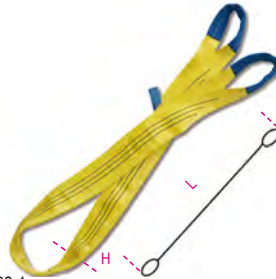

UNI EN 1492-1

L m	H mm	WLL ton	CHF		
1	90	3	19.40	1	081560010
1,5	90	3	25.50	1	081560015
2	90	3	31.50	1	081560020
2,5	90	3	37.00	1	081560025
3	90	3	44.00	1	081560030
3,5	90	3	49.00	1	081560035
4	90	3	54.00	1	081560040
5	90	3	65.50	1	081560050
6	90	3	76.00	1	081560060
8	90	3	100.00	1	081560080
10	90	3	122.00	1	081560100
12	90	3	153.00	1	081560120

8157

Élingue plate, 4t, gris, double couche, boutons renforcées, en polyester haute ténacité (PES)

CE



UNI EN 1492-1

L m	H mm	WLL ton	CHF		
2	120	4	43.50	1	081570020
3	120	4	57.50	1	081570030
4	120	4	74.50	1	081570040
5	120	4	90.00	1	081570050
6	120	4	104.00	1	081570060
8	120	4	135.50	1	081570080
10	120	4	166.00	1	081570100
12	120	4	209.50	1	081570120

8158

Élingue plate, 5t, rouge, double couche, boutons renforcées, en polyester haute ténacité (PES)

CE



UNI EN 1492-1

L m	H mm	WLL ton	CHF		
2	150	5	59.50	1	081580020
3	150	5	78.50	1	081580030
4	150	5	100.50	1	081580040
5	150	5	120.00	1	081580050
6	150	5	142.50	1	081580060
8	150	5	183.50	1	081580080
10	150	5	225.50	1	081580100
12	150	5	284.00	1	081580120

Robur

8159

Élingue plate, 6t, marron,
double couche, boutons renforcés,
en polyester haute ténacité (PES)



UNI EN 1492-1

L m	H mm	WLL ton	CHF		
2	180	6	74.50	1	081590020
3	180	6	109.50	1	081590030
4	180	6	140.00	1	081590040
5	180	6	169.00	1	081590050
6	180	6	197.50	1	081590060
8	180	6	259.00	1	081590080
10	180	6	320.00	1	081590100

8160

Élingue plate, 8t, bleu,
double couche, boutons renforcés,
en polyester haute ténacité (PES)

CE



UNI EN 1492-1

L m	H mm	WLL ton	CHF		
3	240	8	150.50	1	081600030
4	240	8	191.50	1	081600040
5	240	8	227.50	1	081600050
6	240	8	270.00	1	081600060
8	240	8	347.00	1	081600080
10	240	8	433.00	1	081600100

8161

Élingue plate, 10t, orange,
double couche, boutons renforcés,
en polyester haute ténacité (PES)

CE

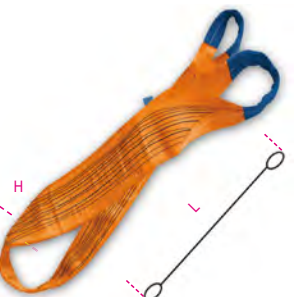

UNI EN 1492-1

L m	H mm	WLL ton	CHF		
3	300	10	207.00	1	081610030
4	300	10	304.00	1	081610040
5	300	10	366.00	1	081610050

L m	H mm	WLL ton	CHF		
6	300	10	425.00	1	081610060
8	300	10	562.00	1	081610080
10	300	10	684.00	1	081610100
12	300	10	822.00	1	081610120

8170

Élingue ronde, 1t, violet,
en polyester haute ténacité (PES)

CE



UNI EN 1492-2

L m	WLL ton	H mm	CHF		
0,5	1	45	7.40	1	081700010
1	1	45	9.70	1	081700020
1,5	1	45	13.60	1	081700030
2,5	1	45	22.00	1	081700050
2	1	45	17.70	1	081700040
3	1	45	26.00	1	081700060
4	1	45	34.00	1	081700080
5	1	45	42.50	1	081700100

8173

Élingue ronde, 2t, vert,
en polyester haute ténacité (PES)

CE



UNI EN 1492-2

L m	H mm	WLL ton	CHF		
0,5	50	2	9.70	1	081730010
1	50	2	14.80	1	081730020
1,5	50	2	21.50	1	081730030
2	50	2	28.00	1	081730040
2,5	50	2	34.50	1	081730050
3	50	2	41.00	1	081730060
4	50	2	55.00	1	081730080
5	50	2	69.00	1	081730100
6	50	2	83.00	1	081730120
8	50	2	108.50	1	081730160

Robur

8176

Élingue ronde, 3t, jaune,
en polyester haute ténacité (PES)

CE



UNI EN 1492-2

L m	H mm	WLL ton	CHF		
0,5	60	3	10.70	1	081760010
1	60	3	19.50	1	081760020
1,5	60	3	28.00	1	081760030
2	60	3	36.50	1	081760040
2,5	60	3	45.00	1	081760050
3	60	3	54.50	1	081760060
4	60	3	72.50	1	081760080
5	60	3	91.00	1	081760100
6	60	3	109.50	1	081760120
8	60	3	144.50	1	081760160

8177

Élingue ronde, 4t, gris,
en polyester haute ténacité (PES)

CE



UNI EN 1492-2

L m	H mm	WLL ton	CHF		
0,5	65	4	21.30	1	081770010
1	65	4	23.10	1	081770020
1,5	65	4	34.00	1	081770030
2	65	4	44.50	1	081770040
2,5	65	4	56.00	1	081770050
3	65	4	67.00	1	081770060
4	65	4	87.50	1	081770080
5	65	4	109.50	1	081770100
6	65	4	131.00	1	081770120
8	65	4	175.00	1	081770160

Robur

8178

Élingue ronde, 5t, rouge,
en polyester haute ténacité (PES)

CE

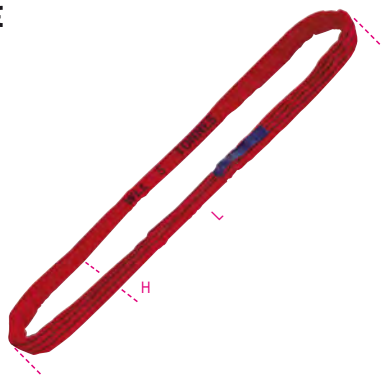

UNI EN 1492-2

L m	H mm	WLL ton	CHF		
0,5	70	5	33.50	1	081780010
1	70	5	28.50	1	081780020
1,5	70	5	42.50	1	081780030
2	70	5	56.00	1	081780040
2,5	70	5	68.00	1	081780050
3	70	5	81.00	1	081780060
4	70	5	108.50	1	081780080
5	70	5	135.50	1	081780100
6	70	5	162.00	1	081780120
8	70	5	216.50	1	081780160

8179M

Élingue ronde, 6t, marron,
en polyester haute ténacité (PES)

CE

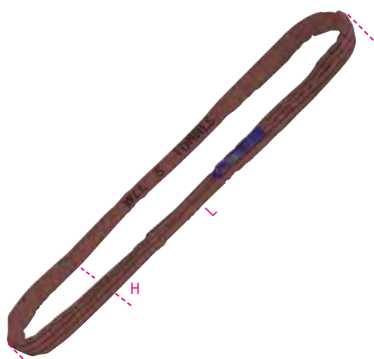

UNI EN 1492-2

L m	H mm	WLL ton	CHF		
1	80	6	36.00	1	081790020
1,5	80	6	52.50	1	081790030
2	80	6	69.50	1	081790040
2,5	80	6	85.50	1	081790050
3	80	6	100.00	1	081790060
4	80	6	134.00	1	081790080
5	80	6	168.50	1	081790100
6	80	6	199.50	1	081790120
8	80	6	267.00	1	081790160

8179B

Élingue ronde, 8 t, bleu,
en polyester haute ténacité (PES)

CE

UNI EN 1492-2

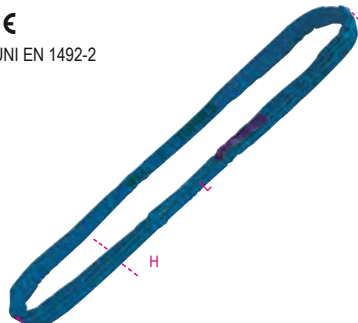

L m	H mm	WLL ton	CHF		
1	85	8	46.00	1	081790220
1,5	85	8	69.50	1	081790230
2	85	8	92.50	1	081790240
2,5	85	8	114.00	1	081790250
3	85	8	132.50	1	081790260
4	85	8	176.50	1	081790280
5	85	8	227.50	1	081790300
6	85	8	265.00	1	081790320
8	85	8	353.00	1	081790360

8179A

Élingue ronde, 10 t, orange,
en polyester haute ténacité (PES)

CE

UNI EN 1492-2

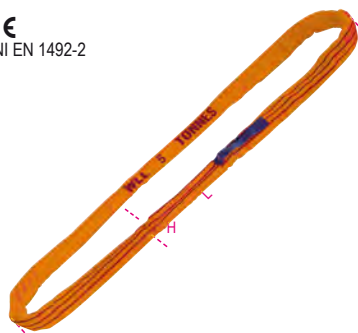

L m	H mm	WLL ton	CHF		
1	95	10	69.00	1	081790502
1,5	95	10	95.50	1	081790503
2	95	10	157.50	1	081790505
2	95	10	135.00	1	081790504
3	95	10	208.50	1	081790506
4	95	10	271.00	1	081790508
5	95	10	304.00	1	081790510
6	95	10	403.00	1	081790512
8	95	10	494.00	1	081790516
10	95	10	676.00	1	081790520
2	100	12	209.50	1	081791204
2,5	100	12	248.00	1	081791205
3	100	12	286.00	1	081791206
3,5	100	12	322.00	1	081791207
4	100	12	362.00	1	081791208
4,5	100	12	366.00	1	081791209
5	100	12	438.00	1	081791210
5,5	100	12	476.00	1	081791211
6	100	12	513.00	1	081791212
6,5	100	12	552.00	1	081791213
7	100	12	590.00	1	081791214
7,5	100	12	627.00	1	081791215
8	100	12	665.00	1	081791216
8,5	100	12	704.00	1	081791217
9	100	12	743.00	1	081791218
9,5	100	12	780.00	1	081791219
10	100	12	817.00	1	081791220
2	110	15	260.00	1	081791504
2,5	110	15	304.00	1	081791505
3	110	15	346.00	1	081791506
3,5	110	15	392.00	1	081791507
4	110	15	435.00	1	081791508
4,5	110	15	477.00	1	081791509
5	110	15	521.00	1	081791510
5,5	110	15	567.00	1	081791511
6	110	15	609.00	1	081791512
6,5	110	15	653.00	1	081791513
7	110	15	697.00	1	081791514
7,5	110	15	739.00	1	081791515

L m	H mm	WLL ton	CHF		
8	110	15	785.00	1	081791516
8,5	110	15	828.00	1	081791517
9	110	15	872.00	1	081791518
9,5	110	15	926.00	1	081791519
10	110	15	959.00	1	081791520
2	130	20	306.00	1	081792004
2,5	130	20	358.00	1	081792005
3	130	20	412.00	1	081792006
3,5	130	20	464.00	1	081792007
4	130	20	518.00	1	081792008
4,5	130	20	570.00	1	081792009
5	130	20	624.00	1	081792010
5,5	130	20	677.00	1	081792011
6	130	20	730.00	1	081792012
6,5	130	20	782.00	1	081792013
7	130	20	835.00	1	081792014
7,5	130	20	888.00	1	081792015
8	130	20	941.00	1	081792016
8,5	130	20	996.00	1	081792017
9	130	20	1,048.00	1	081792018
9,5	130	20	1,101.00	1	081792019
10	130	20	1,154.00	1	081792020
2	135	25	339.00	1	081792504
2,5	135	25	404.00	1	081792505
3	135	25	471.00	1	081792506
3,5	135	25	536.00	1	081792507
4	135	25	604.00	1	081792508
4,5	135	25	670.00	1	081792509
5	135	25	737.00	1	081792510
5,5	135	25	802.00	1	081792511
6	135	25	869.00	1	081792512
6,5	135	25	936.00	1	081792513
7	135	25	1,003.00	1	081792514
7,5	135	25	1,068.00	1	081792515
8	135	25	1,135.00	1	081792516
8,5	135	25	1,200.00	1	081792517
9	135	25	1,270.00	1	081792518
9,5	135	25	1,335.00	1	081792519
10	135	25	1,400.00	1	081792520
2	160	30	397.00	1	081793004
2,5	160	30	477.00	1	081793005
3	160	30	559.00	1	081793006
3,5	160	30	640.00	1	081793007
4	160	30	722.00	1	081793008
4,5	160	30	802.00	1	081793009
5	160	30	883.00	1	081793010
5,5	160	30	963.00	1	081793011
6	160	30	1,045.00	1	081793012
6,5	160	30	1,126.00	1	081793013
7	160	30	1,205.00	1	081793014
7,5	160	30	1,285.00	1	081793015
8	160	30	1,365.00	1	081793016
8,5	160	30	1,445.00	1	081793017
9	160	30	1,525.00	1	081793018
9,5	160	30	1,610.00	1	081793019
10	160	30	1,690.00	1	081793020
2	165	40	552.00	1	081794004
2,5	165	40	616.00	1	081794005
3	165	40	717.00	1	081794006
3,5	165	40	818.00	1	081794007
4	165	40	920.00	1	081794008
4,5	165	40	1,021.00	1	081794009
5	165	40	1,122.00	1	081794010
5,5	165	40	1,225.00	1	081794011
6	165	40	1,325.00	1	081794012
6,5	165	40	1,425.00	1	081794013
7	165	40	1,525.00	1	081794014
7,5	165	40	1,630.00	1	081794015
8	165	40	1,725.00	1	081794016
8,5	165	40	1,835.00	1	081794017
9	165	40	1,935.00	1	081794018
9,5	165	40	2,035.00	1	081794019
10	165	40	2,130.00	1	081794020
3	180	50	831.00	1	081795006
3,5	180	50	949.00	1	081795007
4	180	50	1,065.00	1	081795008
4,5	180	50	1,179.00	1	081795009
5	180	50	1,295.00	1	081795010
5,5	180	50	1,410.00	1	081795011
6	180	50	1,525.00	1	081795012
6,5	180	50	1,645.00	1	081795013
7	180	50	1,755.00	1	081795014
7,5	180	50	1,870.00	1	081795015
8	180	50	1,985.00	1	081795016
8,5	180	50	2,095.00	1	081795017
9	180	50	2,205.00	1	081795018
9,5	180	50	2,330.00	1	081795019
10	180	50	2,440.00	1	081795020



8166

Gaine anti-abrasion pour élingues de levage, en polyester haute ténacité (PES) avec substrat élastomère



H mm	ø mm	L m	CHF		
70	45	3	29.50	1	081660073
80	52	3	34.50	1	081660083
110	70	3	42.00	1	081660103
155	100	3	88.50	1	081660153
170	110	3	98.00	1	081660170
235	150	4	267.00	1	081660235

H mm			
70	8150	8170-8173	081660073
80	8153	8176	081660083
110	8153-8156	8177-8178	081660103
155	8157	8178-8179A 8179B-8179M	081660153
170	8158	-	081660170
235	8159	-	081660235

8090F

Maillon d'assemblage pour élingues polyester, acier allié haute résistance, traitement thermique d'amélioration

CE

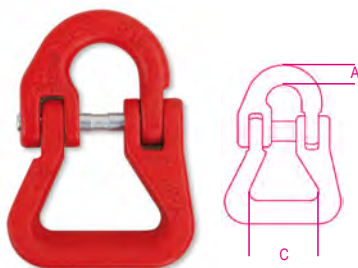

EN 1677-1

CARACTÉRISTIQUES TECHNIQUES

- coefficient de sécurité : 4
- traitement thermique : bonification
- code lot de fabrication

ANALYSES DE LABORATOIRE

- analyse chimique, analyse métallographique
- test charge d'essai (WLL x 2,5)
- essai de traction

- essai de fatigue (min. 20000 cycles)

CERTIFICATS DISPONIBLES

- Spécification produit
- Rapport d'essai type 2.2 UNI EN10204
- Certificat de contrôle type 3.1 UNI EN10204
- Déclaration de Conformité CE

WLL kg	Ø mm	A mm	C mm	CHF		
2000	7-8	10,5	40	36.50	1	080900220
3150	10	12	50	46.00	1	080900232
5300	13	17	60	70.00	1	080900253
8000	16	21	75	107.00	1	080900280

Robur

TENDEUR À CLIQUET

coefficient 2:1

selon norme UNI EN 12195
CARACTÉRISTIQUES TECHNIQUES

- coefficient de sécurité : 2
- code d'identification
- ANALYSES DE LABORATOIRE
- essai pré-tension cliquet
- essai de déformation parties métalliques
- essai de traction système complet
- CERTIFICATS DISPONIBLES
- Spécification produit
- Rapport d'essai type 2.2 UNI EN10204

8180

Arrimage extérieur, 750kg
boucle à rochet
en polyester haute ténacité (PES)

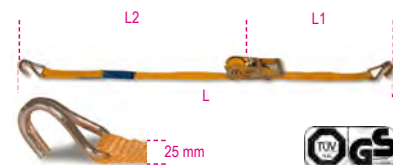

EN 12195-2

L m	L2 mm	L1 mm	STF daN	CHF		
4	3750	250	200	17.90	1	081800004
6	5750	250	200	20.60	1	081800006
8	7750	250	200	23.20	1	081800008

LC = 750 kg

8181

Arrimage extérieur, 1000kg
boucle à rochet
en polyester haute ténacité (PES)

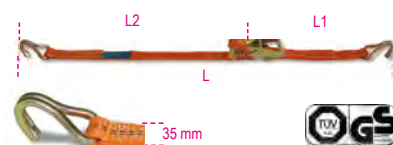

EN 12195-2

L m	L2 mm	L1 mm	STF daN	CHF		
4	3600	400	180	21.80	1	081810004
6	5600	400	180	25.00	1	081810006
8	7600	400	180	27.50	1	081810008

LC = 1000 kg

8181S

Arrimage extérieur, 1000kg,
à deux crochets, boucle à rochete
en polyester haute tenacité (PES)



EN 12195-2

L m	L2 mm	L1 mm	STF daN	CHF		
6	5600	400	180	24.30	1	081810206

LC = 1000 kg

8182E

Arrimage pour intérieurs fourgons et camions, 1000 kg, boucle à rochet en polyester haute ténacité (PES)

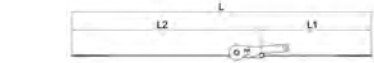

EN 12195-2

L m	L2 mm	L1 mm	STF daN	CHF		
4	3500	500	220	25.00	1	081820440

LC = 1000 kg

	L2 mm	CHF		
8182EL	2500	7.70	1	081820942
8182EC		16.60	1	081820945

8182T

Arrimage extérieur, 1500kg, à deux crochets, boucle à rochet en polyester haute ténacité (PES)

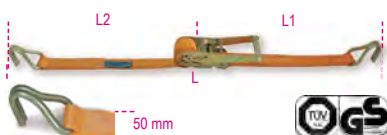

EN 12195-2

L m	L2 mm	L1 mm	STF daN	CHF		
8,5	8100	400	300	38.50	1	081821085
10,5	10100	400	300	42.00	1	081821105

LC = 1500 kg

8182TS

Arrimage extérieur, 1500kg, boucle à rochet en polyester haute ténacité (PES)

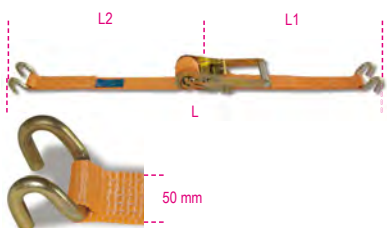

EN 12195-2

L m	L2 mm	L1 mm	STF daN	CHF		
8,5	8100	400	300	39.50	1	081821285
10,5	10100	400	300	44.50	1	081821305

LC = 1500 kg

8182

Arrimage extérieur, 2000kg boucle à rochet en polyester haute ténacité (PES)

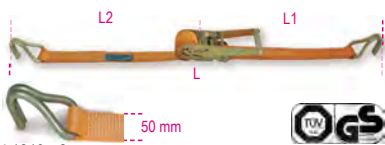

EN 12195-2

L m	L2 mm	L1 mm	STF daN	CHF		
4,5	4100	400	300	34.50	1	081820045
6,5	6100	400	300	41.00	1	081820065
8,5	8100	400	300	44.00	1	081820085
10,5	10100	400	300	50.00	1	081820105
14,5	14100	400	300	57.00	1	081820145
16,5	16100	400	300	65.00	1	081820165

LC = 2000 kg

	L2 mm	CHF		
8182LP	8100	24.30	1	081820902
8182SP		25.00	1	081820905

8182S

Arrimage extérieur, 2000kg à deux crochets, boucle à rochet en polyester haute ténacité (PES)

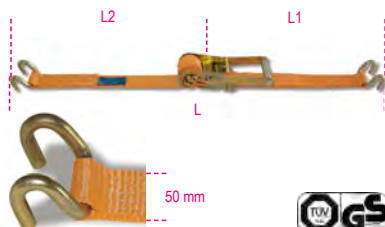

EN 12195-2

L m	L2 mm	L1 mm	STF daN	CHF		
6,5	6100	400	400	39.50	1	081820265
8,5	8100	400	350	46.00	1	081820285
10,5	10100	400	350	50.00	1	081820305

LC = 2000 kg

	L2 mm	CHF		
8182SLP	8100	23.70	1	081820912
8182SSP		24.30	1	081820915

8182GD

Arrimage extérieur, 2000 kg, à crochets delta, boucle à rochet en polyester haute ténacité (PES)



EN 12195-2

L m	L2 mm	L1 mm	STF daN	CHF		
8,5	8100	400	300	52.50	1	081820485

LC = 2000 kg

8182A

Arrimage extérieur, 2 boutonnières, 2000 kg, ruban en polyester haute ténacité (PES)



EN 12195-2

L m	L2 mm	L1 mm	STF daN	CHF		
8,5	8100	400	300	46.00	1	081820585

LC = 2000 kg

8182H

Arrimage extérieur, 2500kg, boucle à rochet en polyester haute ténacité (PES)

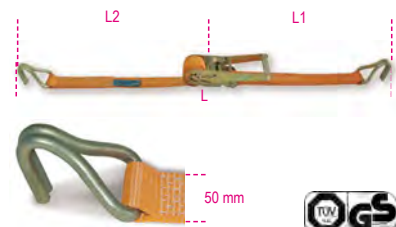

EN 12195-2

L m	L2 mm	L1 mm	STF daN	CHF		
6,5	6100	400	300	44.50	1	081820406
8,5	8100	400	300	48.50	1	081820408
10,5	10100	400	300	53.50	1	081820410
14,5	14100	400	300	67.50	1	081820414

LC = 2500 kg



8182H/2

Arrimage extérieur, 2500 kg,
à deux crochets, boucle à rochet en polyester
haute ténacité (PES)

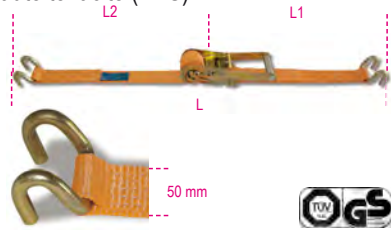

EN 12195-2

L m	L1 mm	L2 mm	STF daN	CHF		
8,5	8100	400	300	51.50	1	081820385

LC = 2500 kg

8184

Arrimage extérieur à cliquet inversé à levier
long, 2500 kg,
boucle à rochet en polyester haute ténacité
(PES)



EN12195-2

L m	L2 mm	L1 mm	STF daN	CHF		
6,5	6100	400	500	49.50	1	081840065
8,5	8100	400	500	52.00	1	081840085
10,5	10100	400	500	56.00	1	081840105

LC = 2500 kg

8183

Arrimage extérieur, 5000 kg,
boucle à rochet
en polyester haute ténacité (PES)



EN 12195-2

L m	L2 mm	L1 mm	STF daN	CHF		
8,5	8000	500	500	140.50	1	081830085
12,5	12000	500	500	168.00	1	081830125

LC = 5000 kg

8190

Tendeur de chaîne d'arrimage à cliquet
avec deux crochets
Grade 8



EN12195/3

Ø mm	LC daN	Ø mm	LC daN	CHF		
10	6300	8	4000	103.00	1	081900010

* ATTENTION : le produit peut être utilisé avec chaîne
8mm et opportune réduction de la charge (LC 4000daN).

8190B

Chaîne d'arrimage



EN12195/3

Ø mm	LC daN	L m	L1 m	CHF		
8	4000	3,5	3,30	214.50	1	081901308
10	6300	3,5	3,28	324.00	1	081901310

8185

Arrimage extérieur sans-fin, 1500kg
boucle à rochet
en polyester haute ténacité (PES)



EN 12195-2

L m	STF daN	CHF		
5	200	14.80	1	081850005
8	200	17.90	1	081850008

8186

Arrimage extérieur sans-fin, 2000kg
boucle à rochet
en polyester haute ténacité (PES)



EN 12195-2

L m	STF daN	CHF		
5	180	17.90	1	081860005
8	180	22.70	1	081860008

8187

Arrimage extérieur sans-fin, 4000kg
boucle à rochet
en polyester haute ténacité (PES)



EN 12195-2

L	STF	CHF		
m	daN			
5	350	33.00	1	081870005
8	350	38.50	1	081870008

8188C

Arrimage extérieur sans-fin, 750kg
boucle à rochet
en polyester haute ténacité (PES)



- 1,5 m
- 2,5 m
- 5,0 m



EN 12195-2

L	STF	CHF		
m	daN			
1,5	72	5.90	3	081880315
2,5	72	7.00	3	081880325
5	72	8.75	3	081880350

8188CG/25

Arrimage extérieur, 2 crochets et boutonnières,
400 kg, boucle à rochet
ruban en polyester haute ténacité (PES)



EN 12195-2

L	L1	L2	STF	CHF		
m	mm	mm	daN			
3	480	170	120	13.20	1	081880430
5	480	170	120	14.10	1	081880450

8188CU/25

Arrimage extérieur avec crochets, 400 kg,
boucle à rochet en polypropylène haute
ténacité (PES)



EN 12195-2

L	L1	L2	CHF		
m	mm	mm			
5	300	4700	13.50	1	081880750

8188F

Arrimage extérieur sans-fin, 200kg
boucle à came
en polypropylène haute ténacité (PP)

- 1,5 m
- 2,0 m
- 2,5 m
- 3,0 m
- 5,0 m

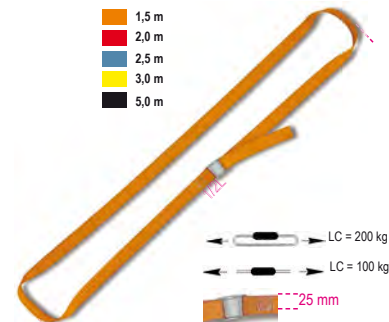

EN 12195-2

L	CHF		
m			
1,5	3.40	10	081880215
2,0	3.65	10	081880220
2,5	4.05	10	081880225
3,0	4.30	10	081880230
5,0	5.45	6	081880250

8188F35

Arrimage extérieur sans-fin, 500 kg,
boucle à came
en polypropylène haute ténacité (PP)

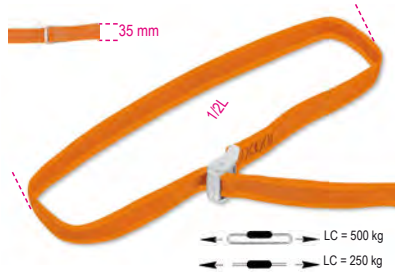

EN 12195-2

L	CHF		
m			
5	12.20	1	081880295

8188VFG2

Arrimage extérieur, 2 crochets et boutonnières,
250 kg, boucle à came
ruban en polypropylène haute ténacité (PP)



EN 12195-2

L	L1	L2	CHF		
m	mm	mm			
3	450	110	17.40	1	081881530

8189

Boucle à rochet en polyester (PES)
pour arrimages extérieures



H	L	LC	CHF		
mm	m	kg			
25	100	750	118.50	1	081890902
35	100	1000	150.00	1	081890903
50	100	2000	240.50	1	081890905

8189A

Tapis antiglisse pour fixer la charge



L	H	S	μ	CHF		
m	mm	mm				
5	250	8	0,6	83.00	1	081890525

8189PA

2 protections angulaires
pour boucles en polyester

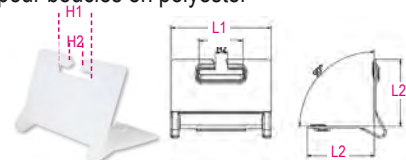

L1xL2	H1	H2	CHF		
mm	mm	mm			
135x90	60	18	5.20	1	081890090

Article	Rapport d'Essai 2.2 (UNI EN 10204)	Certificat de Contrôle 3.1 (UNI EN 10204)	Certificat du Fabricant	Déclaration CE de Conformité
8001Z	✓	✓		✓
8001TZ	✓	✓		✓
8002ZD	✓			
8003ZD	✓			
8004ND	✓			
8005Z	✓			✓
8005TZ	✓			✓
8006Z	✓			✓
8007Z	✓			✓
8008N	✓			✓
8008TZN	✓			✓
8009FD	✓			
8009Z	✓			✓
8009TZ	✓			✓
8010Z	✓			✓
8010TZ	✓			
8015	✓		✓	✓
8016	✓			✓
8016DA	✓			✓
8016FR	✓			
8016U2	✓		✓	✓
8016UGK	✓		✓	✓
8018E	✓			
8018T	✓			
8020A	✓			
8021A	✓			
8025	✓	✓		✓
8026A	✓	✓		✓
8026R	✓	✓		✓
8028	✓	✓		✓
8029R	✓	✓		✓
8031R	✓	✓		✓
8032	✓	✓		✓
8040EN	✓	✓		✓
8040EZ	✓	✓		✓
8042EN	✓	✓		✓
8042EZ	✓	✓		✓
8041	✓	✓		✓
8043	✓	✓		✓
8044	✓	✓		✓
8048	✓			
8049	✓	✓		✓
8049A	✓	✓		✓
8049V	✓	✓		✓
8051S	✓	✓		✓
8052	✓	✓		✓
8057R	✓	✓		✓
8058R	✓	✓		✓
8060R	✓	✓		✓
8061R	✓	✓		✓
8062	✓	✓		✓
8063	✓	✓		✓
8063SL	✓	✓		✓
8064S	✓	✓		✓
8065SC	✓	✓		✓
8068G	✓	✓		✓
8074	✓			
8074A	✓			
8074G	✓			
8080	✓			
8080FM	✓			
8085R	✓	✓		✓
8086	✓	✓		✓
8090	✓	✓		✓
8090F	✓	✓		✓

Article	Rapport d'Essai 2.2 (UNI EN 10204)	Certificat de Contrôle 3.1 (UNI EN 10204)	Certificat du Fabricant	Déclaration CE de Conformité
8090R	✓	✓		✓
8091			✓	✓
8091SL			✓	✓
8092			✓	✓
8092SL			✓	✓
8094			✓	✓
8094SL			✓	✓
8096			✓	✓
8096SL			✓	✓
8097			✓	✓
8097SL			✓	✓
8098			✓	✓
8098SL			✓	✓
8100	✓	✓		✓
8105	✓	✓		✓
8109	✓	✓		✓
8110	✓			
8114	✓			
8116	✓			
8120 - 8120D	✓			
8120B	✓			
8130A	✓			
8135	✓		✓	✓
8139DL	✓			
8143	✓		✓	✓
8146	✓		✓	✓
8146K	✓		✓	✓
8147C-S-P	✓		✓	✓
8148	✓		✓	✓
8149	✓			✓
8150	✓		✓	✓
8153	✓		✓	✓
8156	✓		✓	✓
8157	✓		✓	✓
8158	✓		✓	✓
8159	✓		✓	✓
8160	✓		✓	✓
8161	✓		✓	✓
8166	✓			
8170	✓		✓	✓
8173	✓		✓	✓
8176	✓		✓	✓
8177	✓		✓	✓
8178	✓		✓	✓
8179M-B-A	✓		✓	✓
8180	✓			
8181	✓			
8181S	✓			
8182	✓			
8182A-GD	✓			
8182E	✓			
8182H-H2	✓			
8182M	✓			
8182S	✓			
8182T	✓			
8182T-TS	✓			
8182TS	✓			
8185	✓			
8186	✓			
8187	✓			
8188C	✓			
8188CG/25	✓			
8188CU	✓			
8188F	✓			
8188VF/35	✓			

Article	Rapport d'Essai 2.2 (UNI EN 10204)	Certificat de Contrôle 3.1 (UNI EN 10204)	Certificat du Fabricant	Déclaration CE de Conformité
8188FG2	✓			
8190	✓	✓		
8190B	✓		✓	
8302Z	✓			
8303Z	✓			
8317DZ	✓			
8317SZ	✓			
8381SL	✓			
8381SP	✓			
8383C	✓			
8383P	✓			
8515V	✓			
8515Z	✓			
8531	✓			
8532	✓			
8535	✓			
8201T	✓			
8205	✓			
8206	✓			
8207	✓			
8209	✓			
8210	✓			
8210F	✓			
8210FTP	✓			
8216	✓			✓
8220	✓			
8225	✓			
8227	✓			
8228	✓			
8240	✓			
8240F	✓	✓		✓
8242	✓			
8242F	✓	✓		✓
8248	✓			
8249	✓			
8249G	✓			
8250	✓			
8264	✓			
8267	✓			
8272	✓			
8273	✓			
8274	✓			
8274A	✓			
8274G	✓			
8276	✓			
8276G	✓			
8278	✓			
8280	✓			
8282	✓			
8282S	✓			
8284	✓			
8285	✓			
8286	✓			
8287	✓			
8290	✓			
8293	✓			
8297C	✓			
8297F	✓			
8381SX	✓			
8702...	✓	✓		
8709...	✓	✓		



Beta Collection

Une ligne de produits exclusifs conçue et réalisée afin d'exprimer l'esprit Beta qui compte aujourd'hui plus de 200 créations originales de très haute qualité: équipements sportifs, habillement technique et une multitude d'objets personnalisés. Idéal pour lancer des initiatives promotionnelles et indispensable dans les moments de loisirs.



9500TL

Softshell en tissu polyester 100 %, 320 g, composé de trois couches, coque externe en microfibre, membrane intermédiaire imperméable et respirante, interne en polaire



	CHF		
S	234.50	1	095000051
M	234.50	1	095000052
L	234.50	1	095000053
XL	234.50	1	095000054
XXL	234.50	1	095000055

9501TLD

Pull polaire femme, 80 % coton, 20 % polyester, 320 g/m²



	CHF		
S	114.00	1	095010061
M	114.00	1	095010062
L	114.00	1	095010063
XL	114.00	1	095010064

9501TL

Sweat-shirt homme en coton 80 %, polyester 20 %, 320 g/m²



	CHF		
S	134.00	1	095010051
M	134.00	1	095010052
L	134.00	1	095010053
XL	134.00	1	095010054
XXL	134.00	1	095010055

9502TL
Polo 100 % coton piqué, 210 g/m²



	CHF		
S	78.50	1	095020051
M	78.50	1	095020052
L	78.50	1	095020053
XL	78.50	1	095020054
XXL	78.50	1	095020055

9504TL
Veste en tissu externe 100 % polyester avec traitement hydrofuge



	CHF		
S	158.50	1	095040051
M	158.50	1	095040052
L	158.50	1	095040053
XL	158.50	1	095040054
XXL	158.50	1	095040055

9508TL
Veste imperméable, 100 % polyester



	CHF		
S	132.50	1	095080051
M	132.50	1	095080052
L	132.50	1	095080053
XL	132.50	1	095080054
XXL	132.50	1	095080055

9599 GARAGE

Polo en polyester respirant Beta Garage, 175 g/m², couleur noire



	CHF		
S	37.00	1	095999011
M	37.00	1	095999012
L	37.00	1	095999013
XL	37.00	1	095999014
XXL	37.00	1	095999015

9505TL
Gilet en tissu externe 100 % polyester avec traitement hydrofuge, rembourré 100 g/m² et poche intérieure



	CHF		
S	196.00	1	095050051
M	196.00	1	095050052
L	196.00	1	095050053
XL	196.00	1	095050054
XXL	196.00	1	095050055

9510W
chemise stretch homme, manches longues, 120 g/m², 97% coton, 3% élasthanne. Blanc, avec logo noir. Joug arrière avec deux plis latéraux, col semi-Français. Boutons blancs, deux boutons de brassard. Coupe slim



	CHF		
XS	143.00	1	095100100
S	143.00	1	095100101
M	143.00	1	095100102
L	143.00	1	095100103
XL	143.00	1	095100104
XXL	143.00	1	095100105

9503TL
T-shirt 100 % coton jersey, 160 g/m²



	CHF		
S	51.50	1	095030051
M	51.50	1	095030052
L	51.50	1	095030053
XL	51.50	1	095030054
XXL	51.50	1	095030055

9572LB
Beta-March, 100% coton, 200 g/m² orange, avec inserts noirs



	CHF		
S	62.00	1	095720801
M	62.00	1	095720802
L	62.00	1	095720803
XL	62.00	1	095720804
XXL	62.00	1	095720805

9534WO
polo à deux boutons, en jersey de coton, 200 g/m², blanc avec inserts orange



	CHF		
S	81.00	1	095340031
M	81.00	1	095340032
L	81.00	1	095340033
XL	81.00	1	095340034
XXL	81.00	1	095340035

9534B0

polo à deux boutons, en jersey de coton, 200 g/m², bleu avec inserts gris



	CHF		
S	81.00	1	095340071
M	81.00	1	095340072
L	81.00	1	095340073
XL	81.00	1	095340074
XXL	81.00	1	095340075

9537TL

Pull polaire, 100 % polyester



	CHF		
S	77.50	1	095370051
M	77.50	1	095370052
L	77.50	1	095370053
XL	77.50	1	095370054
XXL	77.50	1	095370055

9580S

Lunettes de soleil

CE



EN ISO 12312-1:2013+A1:2015
UV400
FILTER CAT. III

	CHF		
9580S	43.50	1	095800100

9593S

Smartwatch, touchscreen, fitness tracker, bracelet en silicone



	CHF		
9593S	186.00	1	095930200

9593SB

montre multifonction, écran tactile, tracker de fitness, moniteur de fréquence cardiaque, podomètre, surveillance du sommeil, avec bracelet en silicone, noir

Compatibilité: IOS 8.2 ou supérieur / Android 4.4 ou supérieur
Bluetooth 4.2 Ip67

CE

IP67



	CHF		
9593SB	137.00	1	095930205

9593M

Montre à mouvement automatique, boîtier en acier, résistant à l'eau 5 ATM, bracelet-montre en acier



	CHF		
9593M	453.00	1	095930120

9593A

Chronographe, boîtier en acier, étanche à l'eau 5 ATM, bracelet en silicone



	CHF		
9593A	358.00	1	095930050

9593W

Montre analogique, boîtier en plastique soft touch avec couronne en métal, étanche à l'eau 3 ATM, bracelet en silicone



	CHF		
9593W	78.50	1	095930150

9544C

Trolley dimensions format cabine avec 4 roulettes doubles, cadenas TSA, port USB + jack 3,5 mm



	L	S	H	CHF		
	cm	cm	cm			
9544C	40	20	55	186.50	1	095440101

Beta

9557J 2.0

Sac en polyester enduit/polyester Oxford 600d, dimensions 47x28x25 cm



	L cm	S cm	H cm	CHF		
9557J 2.0	47	25	28	111.00	1	095570020

9557N

Sac "Racing" réalisé en tissu laminé PVC, totalement imperméable



	L cm	S cm	H cm	CHF		
9557N	35	35	80	144.00	1	095570001

9541F

Sac à dos en polyester enduit/polyester Oxford 600d, dimensions 50x33x16 cm



	L cm	S cm	H cm	CHF		
9541F	33	16	50	104.50	1	095410011

9541PC

Sac à dos de travail multipoches, avec poche interne pour ordinateur, 100 % polyester

- Sac à dos avec 3 compartiments, tous avec zip externe étanche
- Premier compartiment avec poche PC
- Poignée supérieure rembourrée
- Prise USB
- Poche latérale en filet pour bouteille d'eau/parapluie
- Insert porte-lunettes sur la bandoulière
- Sangle de poitrine réglable



	L cm	S cm	H cm	CHF		
9541PC	34	18	52	90.50	1	095410041

9541S

Sac à dos en polyester 210D imperméable 33x45 cm



	L cm	H cm	CHF		
9541S	33	45	14.10	1	095410031

9541BIKE

Sac à dos en polyester Oxford, dimensions 41x24x16 cm



	L cm	S cm	H cm	CHF		
9541BIKE	24	16	41	24.80	1	095410021

95740

Gants de travail, avec poignet élastique, pouce et index renforcés, en cuir synthétique permettant l'utilisation de dispositifs à écran tactile

CE



	CHF		
M	47.50	1	095740202
L	47.50	1	095740203
XL	47.50	1	095740204
XXL	47.50	1	095740205

9574B

Gants de travail, avec poignet élastique, pouce et index renforcés, en cuir synthétique permettant l'utilisation de dispositifs à écran tactile

CE



	CHF		
M	47.50	1	095740102
L	47.50	1	095740103
XL	47.50	1	095740104
XXL	47.50	1	095740105

9525TL

Casquette Top Line



	CHF		
9525TL	36.00	1	095250010

9525F

Casquette



	CHF		
9525F	36.00	1	095250099

9525/B

Casquette, 100% coton, taille unique réglable, broderie directe sur le devant, les côtés et l'arrière, blanche



	CHF		
9525B	21.10	5	095251031

9521

Parapluie en nylon T210 avec tige en aluminium 3 sections, noir, automatique



9521	CHF 39.50	1	095210000
------	-----------	---	-----------

95210B

Parapluie en nylon 210T, diamètre 100 cm



95210B	CHF 44.00	1	095210021
--------	-----------	---	-----------

9599CB-N2

vélo de ville, cadre Hi-Ten Tig TKK 700c, dérailleur Shimano® Tourney RD-TZ50, 6 vitesses, V-Brakes®, jantes en aluminium 28 », avec porte-bagages, support et cloche, noir mat



9599CB-N2	CHF 827.00	1	095990031
-----------	------------	---	-----------

9599CB-W

Vélo de ville Atala®, cadre aluminium, dérailleur Shimano® 6 vitesses, freins V-Brake® jantes aluminium 28"



9599CB-W	CHF 827.00	1	095990023
----------	------------	---	-----------

9598W-N

Whistle® VTT, cadre en aluminium, fourche Suntour XCT30, 29 » 100 mm, dérailleur Shimano RD-TX500, freins hydrauliques Shimano BR-M200 à 7 vitesses et jantes en aluminium 29 », orange fluo / gris anthracite mat



9598W-N M	CHF 1,410.00	1	095980130
9598W-N L	CHF 1,410.00	1	095980132

9598WHP-N

Whistle® VTT, cadre en aluminium, fourche Suntour XCM PL, 29 » 100 mm, avec verrouillage à distance, dérailleur Shimano XT RD-M8100 Shadow Plus, freins hydrauliques Shimano BL-MT201/BR-MT200 à 12 vitesses et jantes en aluminium 29 », blanc / rouge mat



9598WHP-N M	CHF 2,650.00	1	095980140
9598WHP-N L	CHF 2,650.00	1	095980142

9515M

Tricot de corps en tissu technique, respirant et à séchage rapide ; empiècements latéraux en filet



	CHF	1	
S	101.50	1	095150051
M	101.50	1	095150052
L	101.50	1	095150053
XL	101.50	1	095150054
XXL	101.50	1	095150055
XXXL	101.50	1	095150056

9516B

Shorts en Lycra 180 g/m², respirants, à séchage rapide, avec élastique à la taille pour un meilleur confort



	CHF	1	
S	117.00	1	095160051
M	117.00	1	095160052
L	117.00	1	095160053
XL	117.00	1	095160054
XXL	117.00	1	095160055
XXXL	117.00	1	095160056

9539CB

Casque de protection pour cyclisme sur route et VTT avec visière amovible - tailles réglable



	CHF	1	
S-M	218.00	1	095390010
L-XL	218.00	1	095390011

9542M

Tricot manches courtes en microfibre respirante, fermeture éclair longue couverte, trois poches arrière dont 1 avec fermeture éclair, élastique en silicone au bas de maillot



	CHF	1	
S	155.50	1	095420051
M	155.50	1	095420052
L	155.50	1	095420053
XL	155.50	1	095420054
XXL	155.50	1	095420055
XXXL	155.50	1	095420056



9542C

Salopette en Lycra, élastique en silicone en bas de jambe, fibre antibactérienne et respirante



	CHF		
S	148.00	1	095420061
M	148.00	1	095420062
L	148.00	1	095420063
XL	148.00	1	095420064
XXL	148.00	1	095420065
XXXL	148.00	1	095420066

9542GW

Blouson d'hiver réalisé en tissu coupe-vent à respirabilité élevée et lainé ; fermeture éclair longue, bande élastique à la taille sans silicone ; poignet adhérent en Lycra ; empiècements réfléchissants arrière ; 3 poches externes arrière, dont 1 avec fermeture éclair



	CHF		
S	269.00	1	095420101
M	269.00	1	095420102
L	269.00	1	095420103
XL	269.00	1	095420104
XXL	269.00	1	095420105
XXXL	269.00	1	095420106

Beta

9542G

Tricot d'hiver en tissu respirant, lainé à l'intérieur, fermeture éclair longue, trois poches à l'arrière, élastique en silicone au bas du tricot



	CHF		
S	155.00	1	095420012
M	155.00	1	095420013
L	155.00	1	095420014
XL	155.00	1	095420015
XXL	155.00	1	095420016
XXXL	155.00	1	095420017

9542S

Collant d'hiver en lycra lainé avec fibre antibactérienne et respirante



	CHF		
S	208.50	1	095420022
M	208.50	1	095420023
L	208.50	1	095420024
XL	208.50	1	095420025
XXL	208.50	1	095420026
XXXL	208.50	1	095420027

9542AT

Gilet coupe-vent en tissu respirant, fermeture éclair longue



	CHF		
S	125.00	1	095420072
M	125.00	1	095420073
L	125.00	1	095420074
XL	125.00	1	095420075
XXL	125.00	1	095420076
XXXL	125.00	1	095420077

9542AL

Coupe-vent imperméable à manches longues respirant



	CHF		
S	199.50	1	095420042
M	199.50	1	095420043
L	199.50	1	095420044
XL	199.50	1	095420045
XXL	199.50	1	095420046
XXXL	199.50	1	095420047

9543C

Cache-cou tubulaire, multifonctions, 100 % microfibre de polyester, sans coutures



	L cm	H cm	CHF		
9543C	25	50	10.90	1	095430100

Beta

Beta

9523T

gourde isolante, en acier inoxydable, 500 ml, technologie double couche, pas d'air entre les parois, bouchon étanche, orange

- garde les boissons froides pendant 24 heures
- garde les boissons chaudes pendant 12 heures



EC1935/EC2023

	ml	L	CHF		
9523T	500	255	27.50	1	095230050

9528B

Gourde en polyéthylène, 500 ml



	ml	CHF		
9528B	500	8.60	1	095280005

9597P

Pompe à pied pour vélo avec manomètre



	CHF		
9597P	80.00	1	095970100

9524SC

Garage Beta en miniature pour collectionneurs



	CHF		
1:18	114.00	1	095240018

9548KB

Vélo "enfant" cadre en acier et Roue 12" avec chambre à air, âge conseillé : + de 3 ans, poids maximum < 30 kg



	CHF		
9548KB	207.00	1	095480110

9548KB 20

VTT pour enfants Atala® 20 », cadre en acier Hi-Ten Tig 20 », fourche à suspension de 30 mm, dérailleur RD-TY21SS 6V, freins en V en aluminium et jantes en aluminium 36 trous, jaune fluorescent / bleu mat



	CHF		
9548KB 20	668.00	1	095480120

9548KB 24

VTT pour enfants Atala® 24 », cadre en acier Hi-Ten Tig 24 », fourche à suspension, dérailleur Shimano Tourney RD-TYZ50 6V, freins en V en aluminium et jantes en aluminium 36 trous, orange fluorescent mat



	CHF		
9548KB 24	712.00	1	095480122

Beta

9547WSK

"Kinder Work Station", établi avec outils pour enfants âgés de 3 ans ou plus



CE

	H	CHF		
9547WSK	cm 74	155.00	1	095473801

9547T

"Kinder trolley", chariot porte-outils avec outils pour enfants à partir de 3 ans



CE

	CHF		
9547T	84.50	1	095470100

9548G

"Kinder Garage" à 6 niveaux, avec autolavage, ascenseur et rampes



	H	CHF		
9548G	cm 69	84.50	1	095480100

9561V 2,5

Drapeau en voile 2,5x0,50 m
avec tige en aluminium
socle cruciforme avec lest circulaire



	L mt	H mt	CHF		
9561V 2,5	0,50	2,5	304.00	1	095610200

9561VV 2,5

Drapeau en voile 2x0,50 m
avec tige



	L mt	H mt	CHF		
9561VV 2,5	0,50	2,5	273.00	1	095610201

9561VV

Drapeau en voile 3,50x0,75 m
avec tige



	L mt	H mt	CHF		
9561VV	0,75	3,50	339.00	1	095610101

9561V

Drapeau en voile 4x0,75 m
avec tige en métal chromé
socle en particules de ciment 50 cm



	L mt	H mt	CHF		
9561V	0,75	4	557.00	1	095610001

9559

Banderole une face en TNT,
module de 3x0,8 m



	L m	H m	CHF		
9559	3	0,8	36.50	1	095591001

9559/30MT

Rouleau 10 logos Beta en TNT



		CHF		
9559/30MT		343.00	1	095591031

9590B

Bannière en nylon sérigraphié
40 x 215 cm



	L cm	H cm	CHF		
9590B	215	140	155.00	1	095900000

9577R

Combinaison de travail, style racing, en tissu extensible 4-way-stretch, 260 g/m², noir et orange, avec inserts blancs et réfléchissants

CE



	I	CHF		
S	48	184.50	1	095770151
M	50	184.50	1	095770152
L	52	184.50	1	095770153
XL	54	184.50	1	095770154
XXL	56	184.50	1	095770155
XXXL	58	184.50	1	095770156

9579C

Blouse en polyester/coton



		CHF		
M		81.00	1	095791002
L		81.00	1	095791003
XL		81.00	1	095791004

9565BBQ

Fût Barbecue en tôle d'acier avec grille et brasier, doté d'un couvercle avec crochet pour la fermeture

Grille en acier chromé (conforme à la norme italienne DM 21.03.73 et règlement CE 1935/2004 en référence à l'aptitude du matériau en contact avec les aliments), dotée de poignées et de pieds d'appui.



	H cm	ø cm	CHF		
9565BBQ	88	59	720.00	1	095650100

9565T

Fût table en tôle d'acier avec plan en bois multicouche de bouleau verni.

Fourni avec double KIT de tubes distanceurs (7 ou 20 cm) pour le réglage de la hauteur.



	H cm	ø cm	CHF		
9565T	95→108	70	609.00	1	095650200

9565S

Fût en tôle d'acier avec chaise en similicuir déhoussable.



9565S	H cm	ø cm	CHF		
	60	38	266.00	2	095650300

9565ICE

Fût en tôle d'acier porte-glace doté d'un couvercle de fermeture, avec récipient anti-rayures, certifié pour usage alimentaire.

L'intérieur du fût est laqué avec un vernis antirouille résistant. Le récipient peut contenir de la glace et des bouteilles/canettes à garder au frais.



9565ICE	H cm	ø cm	CHF		
	60	38	281.00	1	095650400

9565K

Table fût avec deux assises



9565K	CHF		
	1,141.00	1	095650500

9563G

Fauteuil de bureau pour visiteurs



9563G	CHF		
	226.50	1	095630050

9563U

Fauteuil de bureau, ergonomique, avec accoudoirs



9563U	CHF		
	446.00	1	095630020

9549ABW

Bluetooth V5.0 sans fil, avec microphone intégré, charge magnétique, base de charge USB-C, noir

CE



9549ABW	L mm	H mm	S mm	CHF	
	61	34,5	41	41.00	1 095490091

9549SBW

Speaker Bluetooth sans fil, 6 fonctions

Version Bluetooth 5.0

FONCTIONS :

- Bluetooth play
- TF card play
- USB play
- audio jack 3,5 mm
- radio FM
- fonction appel

CE



9549SBW	L mm	S mm	H mm	CHF	
	73	73	124	56.50	1 095490072

9549BP

Batterie portable, 10000mAh



9549BP	CHF		
	29.00	1	095490052

9549CR

Multi-câble de charge 4 en 1, en nylon tressé, à charge rapide

- USB de type A pour la connexion de l'alimentateur
- Connexion Lightning pour les modèles Apple
- Connecteur de charge micro USB
- Connecteur USB-C pour le chargement uniquement
- Connecteur USB-C pour le chargement et la transmission de données



9549CR	L mm	CHF	
	120	21.70	1 095490042

9549MPC

Base de recharge multiprise, 6 ports USB pour une charge multiple jusqu'à une puissance maximale absorbée de 65 W

- 4 ports USB, 5 V 2,4 A
 - 1 port USB, QC 3.0
 - 1 port USB-C, PD 20 W
- avec interrupteur ON/OFF séparé, écran LED pour contrôler le potentiel total, le numéro de port et l'intensité du courant

CE



9545MPC	L mm	S mm	H mm	CHF	
	110	72	35	69.50	1 095490082

9549BRW

Socle de recharge sans fil, avec fonction chargeur rapide et indicateur de charge

- Câble USB-USB Type C inclus, pour la connexion au transformateur, longueur 1 m
- Compatible avec tous les appareils compatibles avec le chargement sans fil
- Input : DC 5 V/2 A, 9 V/2 A, 12 V/1.5 A
- Output : 5 W/ 7,5 W/ 10 W/ 15 W

CE



	Ø	H	CHF		
9549BRW	58 mm	6 mm	39.50	1	095490100

9549C

Clé USB, 32GB



9549C	CHF		
	25.50	1	095490062

9547

Calculatrice de bureau

CE



9547	CHF		
	26.00	1	095470000

9594

Horloge murale avec thermomètre et hygromètre, diamètre 26 cm



9594	Ø	CHF	
	26 cm	38.50	1 095940051

9526P

Machine à café espresso à capsules

Compatible avec capsules Lavazza™, Espresso Point™ utilisation professionnelle



9526P	CHF		
	438.00	1	095260010

9527 6T

Set 6 tasses à café



9527 6T	CHF		
	125.00	1	095270001

9527MUG

Tasse "mug" avec couvercle et bande en silicone



9527MUG	CHF		
	33.00	1	095270020

9522A

Ouvre-bouteilles avec branche ergonomique



9522A	CHF		
	21.80	1	095220010

9523A

Gourde en aluminium, 500 ml



9523A	ml	CHF	
	500	15.10	1 095230005

9586K

Couteau multifonctions en acier, 10 fonctions



9586K	CHF		
	21.10	1	095860100

9526RMN

Kit de 2 jeux de 55 cartes rami Modiano®



9526RMN	CHF		
	36.50	1	095260001

9592B/C50

Lot de 50 stylos



9592B/C50	CHF		
	62.50	1	095920050

9592B/P

Stylos personnalisés



9592B/P	CHF		
	1.88	500	095920051

9592MB

Stylo à bille Parker®



9592MB	CHF		
	101.50	1	095920060

9592M/50

Jeu de 50 crayons



9592M/50	CHF		
	62.50	1	095920100

9588M

Plateau thermoformé souple avec 1 stylo et 2 bloque-notes



9588M CHF 27.00 1 095880011

9596

Porte-badge en polyester avec mousqueton en métal et fil porte-téléphone



9596 CHF 6.35 10 095961001

9595C

Porte-clés en peau



9595C CHF 11.40 1 095950011

9595T

Porte-clés en métal chromé, dans étui de velours



9595T CHF 9.60 1 095950021

9595 C25

Porte-clés en métal chromé, avec crochet en caoutchouc



9595 C25 CHF 12.00 1 095950031

9569P

Sacs en polyéthylène, avec soufflets latéraux



9569P L 34 cm H 44 cm CHF 1.02 50 095691001

9569S

Sac shopper en TNT avec soufflet, 38x42 cm



9569S L 38 cm H 42 cm CHF 3.15 50 095690051

9569MS-2

Shopper en polypropylène à haute résistance



9569MS-2 L 45 cm H 40 cm CHF 8.25 5 095690055

9569MS

Sac shopper en polypropylène à haute résistance, avec double poignées



9569MS L 60 cm H 40 cm CHF 8.25 5 095690052

9587 9x14

Carnet, 9x14 cm



9587 9X14 L 9 cm H 14 cm CHF 17.00 5 095870009

9587 13x21

Carnet, 13x21 cm



9587 13X21 L 13 cm H 21 cm CHF 21.70 5 095870013

9588S/10...

Jeu de 10 blocs-notes



9588S/10A CHF 36.50 1 095881001
21x29 cm
9588S/10B CHF 34.50 1 095881002
15x21 cm
9588S/10C CHF 22.60 1 095881003
10x15 cm
9588S/10D CHF 16.30 1 095880054
7,5x10,5 cm

Beta

9588/10PI

Jeu de 10 blocs-notes à feuilles repositionnables



9588S/10PI
7,5x7,5 cm

CHF 34.00

1 095880055

9589A/36

Paquet de 36 rouleaux de ruban adhésif pour emballage, logo Beta, havane



9589A/36

CHF 175.00

1 095890035

9589B/36

Paquet de 36 rouleaux de ruban adhésif pour emballage, logo Beta, blanc



9589B/36

CHF 175.00

1 095890036

9562TB

Tapis pour essuyage chaussures, avec partie arrière en caoutchouc antiglisse



9562TB

L mm 800 H mm 600

CHF 60.00

1 095620500

9562T2

Tapis pour établi de travail 200x160 cm

- Protège le sol contre les fuites d'huile et d'essence et respecte l'environnement
- Facile à nettoyer, en caoutchouc et antidérapant



9562T2

L cm 200 H cm 160

CHF 301.00

1 095620200

9562T1

garage mat, 100X80 cm

adapté à une utilisation sous les leviers de pneus moto BETA 3071 et 3071B

- fond recouvert de caoutchouc antidérapant facile à nettoyer



9562T1

L cm 100 H cm 80

CHF 110.50

1 095620150

9562T3

Tapis d'atelier
Dimensions : 300x160 cm

- Particulièrement indiqué pour l'utilisation sous les ponts élévateurs moto

- Protège le sol contre les fuites d'huile et d'essence et respecte l'environnement
- Facile à nettoyer, en caoutchouc et antidérapant



9562T3

L cm 300 H cm 160

CHF 438.00

1 095620300

9562P2

Tapis multilogo 200x80 cm

- Particulièrement indiqué pour les utilisations en atelier C55 ou comme tapis à placer sous les motos



9562P2

L cm 200 H cm 80

CHF 211.00

1 095620400

9562P12

Rouleau tapis multilogo de 12 m x 80 cm

Permet de personnaliser la longueur du tapis en fonction des exigences de l'utilisateur



9562P12

L m 12 H cm 80

CHF 1,065.00

1 095620425

Beta

ARTICLES SUPPRIMÉS = ARTICLES DE REMPLACEMENT/RECOMMANDÉS

	ARTICLE SUPPRIMÉ
	ARTICLE DE REMPLACEMENT
	ARTICLE RECOMMANDÉ

96AS/G7	000960745		
111 100	001110010	111E 100	001110110
111 150	001110015	111E 150	001110115
111 200	001110020	111E 200	001110120
111 250	001110025	111E 250	001110125
111 300	001110030	111E 300	001110130
111 380	001110038	111E 380	001110138
111 450	001110045	111E 450	001110145
111 600	001110060	111E 600	001110160
111N 100	001110210	111EN 100	001110410
111N 150	001110215	111EN 150	001110415
111N 200	001110220	111EN 200	001110420
111N 250	001110225	111EN 250	001110425
111N 300	001110230	111EN 300	001110430
111N 380	001110238	111EN 380	001110438
111N 450	001110245	111EN 450	001110445
111G 200	001110620	111CM 170	001110770
111G 250	001110625	111CM 220	001110722
111G 300	001110630	111CM 270	001110727
111HS 200	001114020	111E-HS 200	001114120
111HS 250	001114025	111E-HS 250	001114125
111HS 300	001114030	111E-HS 300	001114130
111HS 380	001114038	111E-HS 380	001114138
111HS 450	001114045	111E-HS 450	001114145
111K 100	001119010		
111K 150	001119015		
111K 200	001119020		
111K 250	001119025		
111K 300	001119030		
410/SPV1	004100420	410/SPVP1	004100421
410/SPV2	004100426	410/SPVP2	004100427
412/SPV1	004120420	410/SPVP1	004100421
412/SPV2	004120426	410/SPVP2	004100427
414/SPV1	004140420	410/SPVP1	004100421
414/SPV2	004140426	410/SPVP2	004100427
415/SPV1	004150420	410/SPVP1	004100421
415/SPV2	004150426	410/SPVP2	004100427
442 22	004420022		
442 24	004420024		
564-3R/VA	005640603	564-3R/V	005640613
564-4R/VA	005640604	564-4R/V	005640614
588	005880001	680/3	006800000
677/50	006770050	677/600	006770006
677/70	006770070	677/800	006770008
677/100	006770100	677/1000	006770010
677/CV1	006770450	677/CVN1	006770455
677/C50	006770606	677/C600	006770607

677/C70	006770611	677/C800	006770612
677/C100	006770615	677/C1000	006770616
677/C150	006770620	677/C1500	006770621
677/CP200	006770720	677/CP2000	006770721
680/2,5	006800002	680/30	006800003
680/40	006800040	680/350	006800035
680/100	006800100	680/2100	006800210
920/55L	009200927		
970OT 65	009700165		
970OT 80	009700180		
970OT 96	009700196		
970OT 111	009700211		
970EA 98	009700398		
970EB 110	009700410		
970EB 95	009700595		
970Q 56	009700756		
970Q 60	009700760		
970C 80	009700808		
970C 95	009700815		
970C 100	009700820		
970C 109	009700829		
970C 115	009700835		
970C 120	009700840		
1046 240	010460240	1044F 250	010440015
1046 400	010460400		
1046K 240	010469240	1044FK 250	010449015
1048 175	010480010	1048N 175	010480910
1048 250	010480015	1048N 250	010480915
1048 300	010480020	1048N 300	010480920
1048V 175	010480110	1048VN 175	010480111
1048V 250	010480115	1048VN 250	010480116
1048V 300	010480120	1048VN 300	010480121
1048K 175	010489010	1048NK 175	010489910
1048VK 250	010489025	1048VNK 250	010489116
1048VK 175	010489110	1048VNK 175	010489111
1048K 250	010489250	1048NK 250	010489915
1309	013090001		
1313	013130001		
1362	013620010	1362B	013620011
1450GC	014500005		
1461/C3B	014610032		
1461/C8G	014610084		
1461/C10G	014610103		
1461/C11G	014610113		
1461/C12G	014610124		
1461/C13A	014610133		
1461/C17B	014610171		
1461/C22B	014610223		
1461/C31B	014610232		

1473Q	014730005		
1498MN/12	014980000	1498BC/12	014980040
1569/A	015690011	1569/SB	015690016
1569/B	015690015	1569/SB	015690017
1590 75	015900307		
1590 125	015900312		
1640K	016400001		
1640T 22,5	016400022		
1640T 25,5	016400025		
1640T 32,5	016400032		
1640T 55,5	016400055		
1640Q 45	016400065		
1640A	016400080		
1640P/9	016400088		
1640P/19	016400089		
1640	016400100		
1651DGT 150	016510111	1651DGTB 150	016510211
1651DGT 200	016510112	1651DGTB 200	016510212
1651DGT/IP	016510611	1651DGTB/IP	016510711
1658DGT25	016580325	1658DGTB 25	016580525
1658DGT50	016580350	1658DGTB 50	016580550
1729	017290001		
1729LR	017290010		
1751 200	017510002	1751N 200	017510020
1751 300	017510003	1751N 300	017510030
1751 500	017510005	1751N 500	017510050
1751 750	017510007	1751N 750	017510075
1751R	017510010	1751NR	017510110
1751 1000	017510011	1751N 1000	017510100
1778D	017780060	1778P	017780088
1778U	017780070	1778AN	017780065
1836A	018360050	1836AW	018360051
1838SL	018380101		
1838S	018380122	1838SW	018380142
1860 160A	018600006	1860BHT/160A	018600179
1860RC/140A	018600604		
1860RC/160A	018600606		
1937 2,5	019370000		
1947M	019470021	1947H	019470011
1947M-ST	019470025		
1947M-T	019470026		
1947M-P	019470027		
1949F	019490027	1949F2	019490028
1949G	019490035		
2029/RT	020290900	C9/RT	021090900
2060/VV	020600101		
2200-COVER RSC22	022000910		
2251-O	022510011		
2252-O	022520001		
2252-R	022520003		

ARTICLES SUPPRIMÉS = ARTICLES DE REMPLACEMENT/RECOMMANDÉS

	ARTICLE SUPPRIMÉ
	ARTICLE DE REMPLACEMENT
	ARTICLE RECOMMANDÉ

2300-COVER RSC23	023000920		
2300-COVER RSC23T	023000930		
TV110	024000477		
T56	024240056		
T110	024240110	T111	024240111
TV56	024249901		
M199	024500199	M201	024500201
M202	024500202	M201	024500201
MV130	024510130		
MV153	024510153		
MV199	024510199		
MV202	024510202		
MV292	024510292		
MV165	024510874		
MBV11	024524211		
MBV34	024524234		
MMV140	024590140		
MCV20	027510020		
3000M/RLS	030000206	3000L/RLS	030000212
3000M/LT	030000220	3000L	030000210
C35/6G	035000062	C35/6GM	035000162
C35/7G	035000072	C35/7GM	035000172
C35/8G	035000082	C35/8GM	035000182
C35/9G	035000092	C35/9GM	035000192
3500/P	035000502		
4100-COVER C41H	041000930		
C43	043000003	C42H	042000002
C45PRO PA	045000280	C45PRO PAS	045000290
C50S-O	050000301	RSC51-FO	051000300
C50S-G	050000302	RSC51-A	051000307
C50S-R	050000303	RSC51-R	051000303
5000MS	050000901	2400 RSC24/MP	024004900
C59A-O	059000001	C59A-O	059000011
C59B-O	059000002	C59B-O	059000012
C59C-O	059000003	C59C-O	059000013
C59A-G	059000021	C59A-A	059000031
C59B-G	059000022	C59B-A	059000032
C59C-G	059000023	C59C-A	059000033
C59A-R	059000041	C59A-R	059000051
C59B-R	059000042	C59B-R	059000052
C59C-R	059000043	C59C-R	059000053
5904VU/2M	059041202	5904VU/2M	059041212
7051MP	070510001		
7212FG 35	072120035	7212G 35	072120335
7212FG 36	072120036	7212G 36	072120336
7212FG 37	072120037	7212G 37	072120337
7212FG 38	072120038	7212G 38	072120338

7212FG 39	072120039	7212G 39	072120339
7212FG 40	072120040	7212G 40	072120340
7212FG 41	072120041	7212G 41	072120341
7212FG 42	072120042	7212G 42	072120342
7212FG 43	072120043	7212G 43	072120343
7212FG 44	072120044	7212G 44	072120344
7212FG 45	072120045	7212G 45	072120345
7212FG 46	072120046	7212G 46	072120346
7212FG 47	072120047	7212G 47	072120347
7212FG 48	072120048	7212G 48	072120348
7213FG 35	072130035	7213G 35	072130135
7213FG 36	072130036	7213G 36	072130136
7213FG 37	072130037	7213G 37	072130137
7213FG 38	072130038	7213G 38	072130138
7213FG 39	072130039	7213G 39	072130139
7213FG 40	072130040	7213G 40	072130140
7213FG 41	072130041	7213G 41	072130141
7213FG 42	072130042	7213G 42	072130142
7213FG 43	072130043	7213G 43	072130143
7213FG 44	072130044	7213G 44	072130144
7213FG 45	072130045	7213G 45	072130145
7213FG 46	072130046	7213G 46	072130146
7213FG 47	072130047	7213G 47	072130147
7213FG 48	072130048	7213G 48	072130148
7217FG 35	072170235	7212B 35	072120235
7217FG 36	072170236	7212B 36	072120236
7217FG 37	072170237	7212B 37	072120237
7217FG 38	072170238	7212B 38	072120238
7217FG 39	072170239	7212B 39	072120239
7217FG 40	072170240	7212B 40	072120240
7217FG 41	072170241	7212B 41	072120241
7217FG 42	072170242	7212B 42	072120242
7217FG 43	072170243	7212B 43	072120243
7217FG 44	072170244	7212B 44	072120244
7217FG 45	072170245	7212B 45	072120245
7217FG 46	072170246	7212B 46	072120246
7217FG 47	072170247	7212B 47	072120247
7217FG 48	072170248	7212B 48	072120248
7219FY 35	072190035	7214G 35	072140235
7219FY 36	072190036	7214G 36	072140236
7219FY 37	072190037	7214G 37	072140237
7219FY 38	072190038	7214G 38	072140238
7219FY 39	072190039	7214G 39	072140239
7219FY 40	072190040	7214G 40	072140240
7219FY 41	072190041	7214G 41	072140241
7219FY 42	072190042	7214G 42	072140242
7219FY 43	072190043	7214G 43	072140243
7219FY 44	072190044	7214G 44	072140244
7219FY 45	072190045	7214G 45	072140245
7219FY 46	072190046	7214G 46	072140246
7219FY 47	072190047	7214G 47	072140247

7219FY 48	072190048	7214G 48	072140248
7328EA 38	073280538	7328A 38	073280638
7328EA 39	073280539	7328A 39	073280639
7328EA 40	073280540	7328A 40	073280640
7328EA 41	073280541	7328A 41	073280641
7328EA 42	073280542	7328A 42	073280642
7328EA 43	073280543	7328A 43	073280643
7328EA 44	073280544	7328A 44	073280644
7328EA 45	073280545	7328A 45	073280645
7328EA 46	073280546	7328A 46	073280646
7328EA 47	073280547	7328A 47	073280647
7328EN 38	073280738	7328N 38	073280838
7328EN 39	073280739	7328N 39	073280839
7328EN 40	073280740	7328N 40	073280840
7328EN 41	073280741	7328N 41	073280841
7328EN 42	073280742	7328N 42	073280842
7328EN 43	073280743	7328N 43	073280843
7328EN 44	073280744	7328N 44	073280844
7328EN 45	073280745	7328N 45	073280845
7328EN 46	073280746	7328N 46	073280846
7328EN 47	073280747	7328N 47	073280847
7340R 36	073400436		
7340R 37	073400437		
7340R 38	073400438		
7340R 39	073400439		
7340R 40	073400440		
7340R 41	073400441		
7340R 42	073400442		
7340R 43	073400443		
7340R 44	073400444		
7340R 45	073400445		
7340R 46	073400446		
7340R 47	073400447		
7525 XS	075250046	7530 XS	075300046
7525 S	075250048	7530 S	075300048
7525 M	075250050	7530 M	075300050
7525 L	075250052	7530 L	075300052
7525 XL	075250054	7530 XL	075300054
7525 XXL	075250056	7530 XXL	075300056
7525 XXXL	075250058	7530 XXXL	075300058
7579T S	075790001	7579QN S	075790201
7579T M	075790002	7579QN M	075790202
7579T L	075790003	7579QN L	075790203
7579T XL	075790004	7579QN XL	075790204
7579T XXL	075790005	7579QN XXL	075790205
7579T XXXL	075790006	7579QN XXXL	075790206
7634G XS	076340100	7637G XS	076370000
7634G S	076340101	7637G S	076370001
7634G M	076340102	7637G M	076370002
7634G L	076340103	7637G L	076370003
7634G XL	076340104	7637G XL	076370004

ARTICLES SUPPRIMÉS = ARTICLES DE REMPLACEMENT/RECOMMANDÉS

	ARTICLE SUPPRIMÉ
	ARTICLE DE REMPLACEMENT
	ARTICLE RECOMMANDÉ

7634G XXL	076340105	7637G XXL	076370005
7634G XXXL	076340106	7637G XXXL	076370006
7634B XS	076340200		
7634B S	076340201		
7634B M	076340202		
7634B L	076340203		
7634B XL	076340204		
7634B XXL	076340205		
7634B XXXL	076340206		
7780T S	077800101	7780QN S	077800201
7780T M	077800102	7780QN M	077800202
7780T L	077800103	7780QN L	077800203
7780T XL	077800104	7780QN XL	077800204
7780T XXL	077800105	7780QN XXL	077800205
7780T XXXL	077800106	7780QN XXXL	077800206
7810 S	078100101	7600G S	076000001
7810 M	078100102	7600G M	076000002
7810 L	078100103	7600G L	076000003
7810 XL	078100104	7600G XL	076000004
7810 XXL	078100105	7600G XXL	076000005
7812 S	078120001	7610G S	076100001
7812 M	078120002	7610G M	076100002
7812 L	078120003	7610G L	076100003
7812 XL	078120004	7610G XL	076100004
7812 XXL	078120005	7610G XXL	076100005
7813 S	078130001	7611G S	076110001
7813 M	078130002	7611G M	076110002
7813 L	078130003	7611G L	076110003
7813 XL	078130004	7611G XL	076110004
7813 XXL	078130005	7611G XXL	076110005
7816G XS	078160000	7818G XS	078180000
7816G S	078160001	7818G S	078180001
7816G M	078160002	7818G M	078180002
7816G L	078160003	7818G L	078180003
7816G XL	078160004	7818G XL	078180004
7816G XXL	078160005	7818G XXL	078180005
7816G XXXL	078160006	7818G XXXL	078180006
7816BL XS	078160100	7818BL XS	078180100
7816BL S	078160101	7818BL S	078180101
7816BL M	078160102	7818BL M	078180102
7816BL L	078160103	7818BL L	078180103
7816BL XL	078160104	7818BL XL	078180104
7816BL XXL	078160105	7818BL XXL	078180105
7816BL XXXL	078160106	7818BL XXXL	078180106
7817N S	078170101	7600N S	076000101
7817N M	078170102	7600N M	076000102
7817N L	078170103	7600N L	076000103

7817N XL	078170104	7600N XL	076000104
7817N XXL	078170105	7600N XXL	076000105
7819B S	078190101	7610N S	076100101
7819B M	078190102	7610N M	076100102
7819B L	078190103	7610N L	076100103
7819B XL	078190104	7610N XL	076100104
7819B XXL	078190105	7610N XXL	076100105
8021 3	080210003	8021A 3	080210103
8021 5	080210005	8021A 5	080210105
8021 6	080210006	8021A 6	080210106
8021 8	080210008	8021A 8	080210108
8021 10	080210010	8021A 10	080210110
8021 12	080210012	8021A 12	080210112
8021 14	080210014	8021A 14	080210114
8021 16	080210016	8021A 16	080210116
8021 18	080210018	8021A 18	080210118
8021 20	080210020	8021A 20	080210120
8021 22	080210022	8021A 22	080210122
8021 24	080210024	8021A 24	080210124
8021 26	080210026	8021A 26	080210126
8021 28	080210028	8021A 28	080210128
8021 30	080210030	8021A 30	080210130
8021 32	080210032	8021A 32	080210132
8021 35	080210035	8021A 35	080210135
8041 M16	080410216	8041HP M16	080410217
8041 M20	080410220	8041HP M20	080410221
8043 M16	080430216	8043HP M16	080430217
8043 M24	080430224	8043HP M24	080430225
8050D29	080500974		
8057 5,3	080570053	8057R 5,3	080570153
8058 8,0	080580080	8058 8,0	080580180
8060 8	080600080	8060R 8000	080600180
8061F 8	080610180	8061R 8,0	080610280
8085 8,0	080850080	8085 8,0	080850280
8085 11,2	080850190	8085 11,2	080850311
8090 8,0	080900080	8090 8,0	080900180
8131Z 6X800	081310068		
8131Z 8X1000	081310081		
8131Z 8X1200	081310082		
8131Z 10X1500	081310105		
8135/KLA 0,75	081350905	8135/KLA1 0,75	081350605
8135/KLA 0,75	081350905	8135/KCA 0,75	081350630
8135/KLA 0,75	081350905	8135/KMO 0,75	081350655
8135/KLA 1,0	081350910	8135/KLA1 1,0	081350610
8135/KLA 1,0	081350910	8135/KCA 1,0	081350635
8135/KLA 1,0	081350910	8135/KMO 1,0	081350660
8135/KLA 2,0	081350920	8135/KLA1 2,0	081350615
8135/KLA 2,0	081350920	8135/KCA 2,0	081350640
8135/KLA 2,0	081350920	8135/KMO 2,0	081350665
8135/KLA 3,0	081350930	8135/KLA1 3,0	081350620
8135/KLA 3,0	081350930	8135/KCA 3,0	081350645
8135/KLA 3,0	081350930	8135/KMO 3,0	081350670

8135/KLA 5,0	081350950	8135/KLA1 5,0	081350625
8135/KLA 5,0	081350950	8135/KCA 5,0	081350650
8135/KLA 5,0	081350950	8135/KMO 5,0	081350675
8139Z 10	081390009		
8143/RK 0,5	081430905	8143/RKL 0,5	081430500
8143/RK 0,5	081430905	8143/RPC 0,5	081430510
8143/RK 0,5	081430905	8143/RPF 0,5	081430520
8143/RK 1,0	081430915	8143/RKL 1,0	081430501
8143/RK 1,0	081430915	8143/RPC 1,0	081430511
8143/RK 1,0	081430915	8143/RPF 1,0	081430521
8143/RK 2,0	081430920	8143/RKL 2,0	081430502
8143/RK 2,0	081430920	8143/RPC 2,0	081430512
8143/RK 2,0	081430920	8143/RPF 2,0	081430522
8143/RK 3,0	081430930	8143/RKL 3,0	081430503
8143/RK 3,0	081430930	8143/RPC 3,0	081430513
8143/RK 3,0	081430930	8143/RPF 3,0	081430523
8143/RK 5,0	081430950	8143/RKL 5,0	081430504
8143/RK 5,0	081430950	8143/RPC 5,0	081430514
8143/RK 5,0	081430950	8143/RPF 5,0	081430524
8146/RK 0,75	081460908	8146/RKL 0,75	081460500
8146/RK 0,75	081460908	8146/RPC 0,75	081460510
8146/RK 0,75	081460908	8146/RKFC 0,75	081460520
8146/RK 1,5	081460915	8146/RKL 1,5	081460501
8146/RK 1,5	081460915	8146/RPC 1,5	081460511
8146/RK 1,5	081460915	8146/RKFC 1,5	081460521
8146/RK 3,0	081460930	8146/RKL 3,0	081460502
8146/RK 3,0	081460930	8146/RPC 3,0	081460512
8146/RK 3,0	081460930	8146/RKFC 3,0	081460522
8146/RK 6,0	081460960	8146/RKL 6,0	081460503
8146/RK 6,0	081460960	8146/RPC 6,0	081460513
8146/RK 6,0	081460960	8146/RKFC 6,0	081460523
9557J 3,0	095570030		
9577M S	095770051	9577R S	095770151
9577M M	095770052	9577R M	095770152
9577M L	095770053	9577R L	095770153
9577M XL	095770054	9577R XL	095770154
9811L T100 (1-2)	098110510		
9811L T100 (3)	098112510		
9812M T100 (1-2)	098120510		
9812M T100 (3)	098122510		
9813H T100 (1-2)	098130510		
9813H T100 (3)	098132510		
9821L T100 (1-2)	098210510		
9821L T100 (3)	098212510		
9822M T100 (1-2)	098220510		
9822M T100 (3)	098222510		
9823H T100 (1-2)	098230510		
9823H T100 (3)	098232510		
9851 500 (1-2)	098510050		
9851 500 (3)	098512050		
11050 180X7	110500180		



Accessoires inox pour cordes	658÷663
Accessoires porte-outils pour armoires, tiroirs et parois	518÷520
Accessoires pour câbles Robur	631÷671
Ameublement de l'atelier	398÷440
Anneau de levage	640÷643
Appareils à collets pour cuivre et alliages légers	32-33
Armoires d'atelier	420÷422, 439
Armoires porte-outils	390, 419
Aspirateur eau et poussières pour usage professionnel	256-257
Aspirateur pour liquides	259
Bacs de rangement magnétiques	239
Bédanes	10
Beta Abrasifs	527÷543
Beta BM	547÷553
Beta Chimie	521÷526
Beta Collection	672÷683
Bloquant	523
Boîtes à outils	348÷351
Bornes terminales	549
Brosses	227, 314
Brucelles	126÷128, 291
Burettes	230-231
Burins	10, 294, 302, 306, 314
Burins plats de carrossier	126, 161
Caméra thermique	237
Casse-écrous	221
Chaînes et colonnes de délimitation en plastique	628
Chariot pliable	355, 375
Chariot à plate-forme électrique	386
Chariots porte-coffres	358
Chariots porte-outils tank avec étagère	368÷370, 385, 387-388, 413, 435
Chasse-clous	9, 306
Chasse-cônes Morse	44
Chasse-goupilles	9, 306, 509
Chaussures de sécurité	583÷611
Cisailles	136-137
Ciseaux	138, 242, 314
Ciseaux de maçon	220
Ciseaux d'électricien	137-138, 291, 297
Clé polygonale pour échafaudage	17, 308
Clés à béquilles à cardan et pour vis Torx®	115÷117
Clés à douilles articulées	15, 496,
Clés à douilles emmanchées	113-114, 291, 570
Clés à ergots	23-24, 64, 309
Clés à fourches	14-15, 289, 295, 307
Clés à fourches à patte de coq avec carré femelle 3/8"	96
Clés à frapper	14-15, 307-308
Clés à molette	24, 63, 289, 295, 303, 309
Clés à pipe	112-113, 296, 311
Clés à tuyauter	17
Clés à tuyauter à cliquet	25÷27, 296
Clés de serrage angulaire	61
Clés de serrage antidéflagrantes pour vannes de sécurité	307÷311
Clés dynamométriques	60÷69, 289, 296
Clés dynamométriques sans accessoire	62, 67÷69
Clés en tube	111-112
Clés mâles 6 pans en T et pour vis Torx®	115÷117, 291, 311



Clés mâles 6 pans et pour vis Torx®	18-23
Clés mâles 6 pans et pour vis Torx® à poignée en T haute performance	21÷23, 191, 295, 303,
Clés mâles coudées XZN®	23
Clés mixtes	11÷13, 25-26, 296, 302, 307
Clés polygonales	15,÷17, 289, 295, 307-308
Clés pour tableautiers	213
Clés serre-tubes	33-34, 296, 303, 309
Coffres	357÷359, 372-373, 377-378, 382,
Coffres industriels	357÷359, 372-373, 377-378, 382,
Coffres porte-outils équipé de roues	349, 351
Coffret de réparation des filetages endommagés M5-M6-M8-M10-M12	46-47
Coffrets de tarauds	43÷45
Colle instantanée	524
Colliers en nylon	550÷553
Combo coffres et accessoires	352÷356
Comparateurs	215
Compas	216-217
Compositions d'outils	441÷492
Compteur de litres numérique pour huile	259
Contrôleur de couple électronique avec controleur de couple Dynatester	70
Cordeau et poudre à tracer	221
Cosses cœur	638
Cosses préisolées	548
Coupe-boulons	135
Coupe-câbles	139, 291
Coupe-câbles gros effort	135
Coupe-tube PVC à cliquet	30
Coupe-tubes	28÷30, 32, 309
Coussin élévateur	242
Couteaux	241, 293, 314,
Crayon de menuisier	218
Cutters à lame sécable	240
Cuve de lavage à ultrasons	263-264
Débloquant spray	524
Dégivrant	526
Dénudeurs et pinces à dénuder	139-140
Détergents	525-526
Disques à lamelles	535÷539
Disques abrasifs	529÷531, 542
Disques magnétiques avec poignée pour le soudage	255
Doigts magnétiques flexibles	221
Doigts mécaniques flexibles à griffes	222
Douilles à chocs, accessoires et compositions	70÷74
Douilles, accessoires et compositions 1"	109-110
Douilles, accessoires et compositions 1/2"	99÷108, 290-291, 303, 310
Douilles, accessoires et compositions 1/4"	86÷93
Douilles, accessoires et compositions 3/4"	108-109, 310-311
Douilles, accessoires et compositions 3/8"	93÷98, 289-290, 309
Ébavureurs tonneau	31
Élévateur pour vélos	283
Elingue à chaîne de levage	644÷650
Embouts pour visseuses et porte-embouts	25, 78÷85, 150-151, 155, 289
Emporte-pièces	135-136
Enrouleur automatique pour l'air comprimé ou l'eau froide	337
Enrouleurs automatiques avec baladeuse	248÷250
Équerres	215-216
Équerres magnétiques pour postes à souder	255
Établi mobile	371

Établis de travail	389,391-392,394÷397,402÷404, 407, 430-431,
Étalonneur pour tuyaux multicouche	31
Étau magnétique pour le soudage	255
Étaux parallèles d'établi	212
Étaux pour tubes, pour plomberie	35
Extracteurs à 2 griffes	201÷205, 211
Extracteurs à 3 griffes	202÷205, 211
Extracteurs de vis et goujons endommagés	170-171
Extracteurs hydrauliques	211
Extracteurs pour moyeux et tambours de roues	205-206
Extracteurs, divers	201÷211
Fers à souder	253-254
Fers à souder et embouts	28
Fers à souder les tubes d'évacuation en PE, PP, PVC et PEHD	28
Filières et compositions	47÷51
Forets à dépointer en acier HSS	41
Forets coniques	41-42
Forets laminés en acier HSS	36÷42
Forets pour percer, fileter et aléser	47
Frein filet	522
Gaines isolantes	553
Gamme blister	554÷568
Gants isolants	293
Graisse en spray	524-525
Grattoirs	173, 186, 222, 240, 314
Hache antidéflagrante	314
Jauges à rayons	221
Jauges de filetage	221
Jauges d'épaisseur	221
Joint liquide	523
Kit de réparation des pièces en plastique	166
Lames réversibles	155-156
Lampes	244÷248
Leviers	123, 221, 311
Limes	161, 223÷226, 314
Lunettes de protection	629
Magnétiseur/démagnétiseur	145
Maillets	169-170, 299, 313,
Manille de levage	639-640,655
Marche pied	239
Marteaux	162, 166÷168, 312, 298-299, 304
Masque antipoussière	629
Masque pour soudage	255-256
Masses	169, 313
Massettes	169, 313
Mastic silicone	524
Mesures Météorologiques et de lumières	237-238
Mètres à ruban et pliants	218
Meules abrasives sur tige	532÷535
Micromètres	214
Micro-tournevis	151
Miroirs d'inspection	222
Modules en mousse d'outils	494÷517
Modules mousse d'outils	493÷518
Montures et lames de scie	226
Multimètres	234-235
Multiplicateurs de couple	55-56



Nettoyant Freins	525-526
Niveaux	219-220
Outillage pneumatique et accessoires	318÷340
Outils à batterie	315
Outils anti-chute	294÷300
Outils antidéflagrants	306÷314
Outils en acier inoxydable	301÷305
Outils isolés 1000V	287÷293
Outils pour motocycles	276÷281
Outils pour vélos	282÷286
Palans manuels et accessoires	650÷652
Panneaux d'avertissement	629
Parois porte-outils	365, 376, 393, 414, 416-417, 436-437
Pelle antidéflagrante	314
Pic antidéflagrant	314
Pieds à coulisse universels	213-214
Pince à plier	133
Pince à poinçonner	133
Pince emporte-pièces 6 diamètres	238
Pince pour câbles	637-638
Pince pour colliers	552
Pince pour soudure	255
Pince pour soulever les tôles	649
Pinceau de nettoyage	227
Pincés à becs longs	128, 140÷144, 292, 298, 311
Pincés à cintrer	34-35
Pincés à cosses et cosses	544÷546
Pincés à riveter et rivets	227÷229
Pincés ampèremétriques	235-236
Pincés coupantes de précision	144-145
Pincés coupantes diagonales et frontales	133-134
Pincés de précision	143-144
Pincés multiprises entrepassées	130-132, 140-141, 184, 297, 303, 312,
Pincés pour circlips intérieurs	129-130, 173, 209, 296-297, 311
Pincés tordeuse de fils	238
Pincés universelles	140-141, 292, 298, 303, 312
Pincés-étaux	131÷133, 297, 303
Pistolet à huile	259
Pistolets à colle	250
Pistolets à silicone	229
Pistolets de peinture professionnel	337
Pistolets thermiques	250
Plomberie, divers	28÷35
Pointeaux	10
Pointes	222
Pointes à tracer	217-218
Pompe à graisse à levier	230
Pompe oléohydraulique	163
Pompes à dessouder	254
Pompes à graisse à levier	229
Pompes pour barils	259
Porte-flacons	365-366
Porte-outils avec ceinture	344
Postes à souder	254-255
Presses d'assemblage	212
Produits électriques	544÷553
Protection pour coffres	381
Rapporteur d'angles	216



Rapporteurs d'angles simples	216
Réglets	217, 299
Renvoi d'angle	84
Réparation automobile	117÷126, 160÷166, 170÷211, 231÷239
Roues à lames et disque fibre	540÷542
Rouleaux de toiles abrasives	543
Ruban isolant	553
Sac à dos porte-outils	347-348
Sacoche porte-outils	333, 336÷338
Sangle en velcro	552
Sangles et élingues de levage	664÷667
Scellant à filet	522
Scie égoïne à bois	226
Scies trépan, fraises et accessoires	51÷53
Seringue à huile	231
Serre-joints et presses à vis	212
Servantes mobiles d'atelier	360÷368, 374÷381, 408-409, 431
Siège mobile d'atelier	265÷267
Silicone spray	525
Solutions pour le point de vente	569÷582, 629-630
Sonde tire-fils en nylon	546
Spatules	226, 314
Spot à LED	245
Spray imperméabilisant	526
Support pour clés à chocs	324
Support rouleaux de papier	365
système d'ancrage	663, 667÷670
Tachymètre digital	236
Tapis de travail	266, 278, 293, 397, 652
Tapis isolant	293
Tapis pour protection des genoux	266
Télémètres	218
Tenailles	134-135
Tendeurs pour cordes et accessoires	632÷637
Testeur de tension	237
Thermomètres	237
Tire-ressorts	226
Torches	243-244
Tournes-à-gauche et porte-filières	46, 49
Tournevis à frapper	158-159
Tournevis à zone de frappe	149-150
Tournevis BetaEVOX	146÷148
Tournevis BetaGrip	152÷155, 292-293
Tournevis BetamaX	157÷159, 304, 312
Tournevis coudés	149
Tournevis détecteurs de tension	150
Tournevis dynamométriques	60
Tournevis pose-vis	150
Treuil manuel et accessoires	652÷658
Valises porte-outils	345-346, 348-349, 383-38
Valises porte-outils	342÷346, 352÷355
Ventouses	238
Vérin hydraulique	211
Vêtements techniques	612÷630
Vidéoscope électronique	123
Zinc spray	526

Automotive



Aléseuses pour le nettoyage des sièges des injecteurs	122
Aspirateur de vapeur pour injecteurs Diesel	122
Autoscope	201
Barre télescopique	239
Boosters de démarrage	198
Centreurs d'embrayage	172
Chandelles	268
Chargeurs de batterie	198÷200
Chariot de déplacement véhicules	268
Chariot de déplacement véhicules	268
Chariot pour maintenance des boîtes de vitesses et transmissions	388
Chevalets pour motos	277
Clé pour démontage/montage turbines	184
Clés à bougies	118
Clés en croix pour écrous de roues	124
Clés pour bouchon de trappe de réservoirs de carburant	187
Clés pour capteurs de température	120
Clés pour filtres à huile moteur	190÷193
Clés pour filtres diesel	193
Clés pour raccords d'injecteurs	176
Clés pour vannes de réservoirs méthane	189-190
Clés réversibles pour bouchons de vidange	194-195
Colliers à segments	173
Compresseurs pour ressorts d'amortisseurs	209
Compressiomètre et accessoires	177÷180
Compressiomètre pour moteurs à essence et Diesel	121-122
Couchettes d'atelier	266-267
Cric hydropneumatique	275
Cric rouleur hydraulique à roues	273-274
Crics bouteilles hydrauliques	269
Crochets pour traction des ressorts	170
Cuve de lavage des pièces	263÷265
Cuves de récupération des liquides	258-259
Détecteur de signal	236
Douilles à chocs à contrôle de couple	77
Douilles à chocs pour écrous de roues	72-73
Douilles à chocs pour écrous de roues Isuzu	76
Douilles de serrage pour écrou de moyeu	124
Douilles pour axes de ressort à lames	209
Douilles pour injecteurs Diesel	118-119
Douilles pour sonde Lambda	119
Élévateur hydraulique pour le montage/démontage des roues des poids-lourds	268
Emportes-pièces pour capteurs de stationnement	165

Entonnoir	232, 314
Extracteur de rotules axiales de direction	210
Extracteur pour lèche-vitres	239
Extracteurs de rotules	210
Extracteurs pour joints homocinétiques	210
Flacons de remplissage pour batterie	231
Grue hydraulique pliable	270
Injecteurs à percussion pour roulements coniques et déflecteurs d'huile	211
installateur pneumatique talon de pneus	336
Jauge de profondeur pour le contrôle d'usure des pneus	221
Jauges d'épaisseur pour carrossiers	162
Kit de débosselage	162-163
Kit dérive chaînes	280
Kit outillage pour blocage des poulies de distribution	177
Kit outillage pour véhicules lourds	124
Lavage de voiture intérieur/extérieur	256-257, 265
Lèves pare-brise	238
Lève-soupapes	162
Levier dépose brides d'amortisseur	210
Levier pour boîtes de vitesses DSG	172
Leviers de compression des poussoirs de soupapes	180
Leviers démonte-pneus	123, 285
Limes de carrossier	161
Marteaux de carrossier	162
Nettoyeur de cosses de batterie	227
Outil pour extraire les joints	206
Outil pour positionner les pistons de frein à disque	181
Outils dépose-autoradios	238
Outils pour déblocage des connecteurs électriques	196
Outils pour enlever les airbags	172
Outils pour extraction bobines de bougies	183
Outils pour extraction injecteurs Diesel Common Rail	121
Outils pour installations de climatisation	188
Outils pour le calage des moteurs	173÷176
Outils pour le contrôle de l'étanchéité de l'installation de refroidissement	233
Outils pour le démontage des bougies de préchauffage	121-122
Outils pour le démontage des silentblocks	211
Outils pour remplissage filtres gasoil	186
Outils pour valves pneus	124-125
Palettes de carrossier	161
Pèse-acides	233
Pèse-antigel	233
Pieds à coulisse pour disques et tambours de freins	73
Pince à joncs extérieurs	173
Pince à masses d'équilibrage	126
Pince à relais	195-196
Pince pour agrafes	238
Pince pour caches-écrous de roues	125



Pince pour joints d'étanchéité de soupapes	173
Pinces à durites	187
Pinces coupe-tubes d'échappement	184
Pinces d'extraction de clips	185
Pinces pour colliers auto-serrants	182-183
Pinces pour connecteurs de bougies	184
Pinces pour garniture de frein	180
Pinces pour raccords d'essence	187
Pistolet de gonflage	336
Pivots guide pour montage roues	125
Plaque modulaire en aluminium	232
Pompe à tarer les injecteurs Diesel	122
Poste de recharge de climatiseur	262÷263
Poste de travail mobile pour instruments de diagnostic	385
Poste pour la maintenance de la boîte de vitesses automatiques	260
Presse hydraulique	271-272
Protections automobile	266
Protections pour roues	124
Purgeur de freins pneumatique par dépression	179-180
Récupérateurs par gravité	257-258
Rodoir de soupapes pneumatique	173
Sableuse d'établi professionnelle	264
Spatules en acier inox	161
Spotter sur chariot pour carrossiers	164÷165
Stabilisateur de tension	201
Stations de lavage des composants moteurs	265
Supports moteur	269
Tas de carrossier	160-161
Testeur de tension	196
Testeur pour batteries et installations de recharge	201
Ventouse de débosselage pneumatique	164
Vérin hydraulique de fosse et sous-pont	270-271

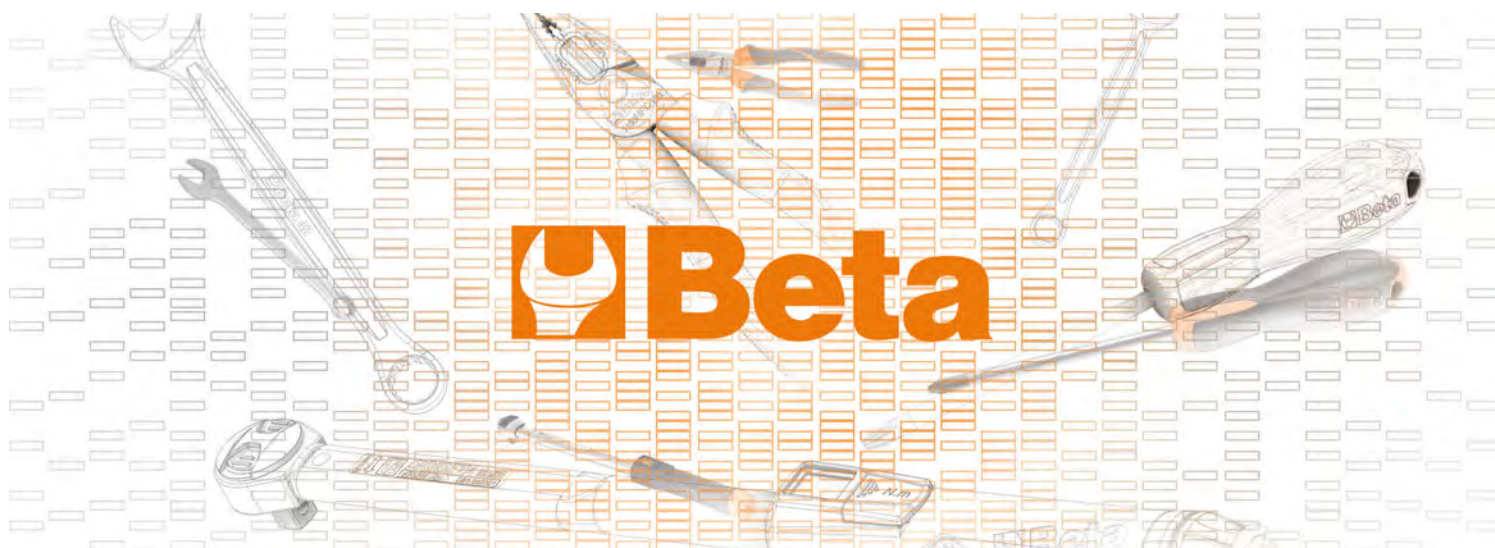

1		1032HS	296	1081	133	1126	137	1149F	140
		1032BA	311	1082	133	1127	137	11491	543
100	24	1032K	559	1082BM	133	1128BAX	137	11493	543
100/KIT	24	1033	129	1082G	133	1128BMX	137	11495	543
110BA	309	1033K	559	1082GBM	134	1128BMX/F	137	11498	543
110MQ	289	1034	129	1082MQ	291	1128BM	138	1150	140
111CM	24	1034L	129	1082BM-HS	297	1128BSX	138	1150G	140
111E	24	1034HS	297	1082INOX	303	1128FX	138	1150BM	141
111EN	24	1034K	559	1082BA	312	1128FXS	138	1150GBM	141
111ER	24	1036	129	1082GK	559	1128MQ	291	1150HPC	141
111E-HS	295	1036HS	297	1082K	559	1128BAX-HS	297	1150MQ	292
111INOX	303	1036BA	311	1082BMK	560	1129BM	138	1150BM-HS	298
120	25	1036K	559	1082GBMK	560	1129BMK	561	1150INOX	303
120/B6N	25	1037	129	1084	134	1130BMX	138	1150BA	312
123/K4	25	1037K	559	1084BM	134	11300A	541	1150BMK	561
123E1/4	25	1038	129	1084G	134	11300B	541	1150GBMK	561
123Q1/2	25	1038HS	297	1084GBM	134	11300C	541	1150GK	561
123Q1/4	25	1038K	559	1084MQ	291	11300D	541	1150K	561
123Q3/8	25	1039	130	1084BMK	560	11300E	541	1153	141
141	25	1044	130	1084GBMK	560	11300F	541	1153INOX	303
141/B	25	1044F	130	1084GK	560	11300G	541	1162	141
141/S	25	1044FK	559	1084K	560	1131CK	138	1162BM	142
142	25	1044K	559	1088	134	1132	139	1162G	142
142/B	26	1046BA	312	1088BM	134	1132BM	139	1162GBM	142
142/S	26	1047	130	1088MQ	291	11320	541	1162MQ	292
142/SC9I-E	26	1047BM	130	1088BM-HS	297	1132MQ	291	1162BA	312
142AS	26	1048BM	130	1088BMK	560	1132BM-HS	298	1162BMK	561
142AS/S	26	1048N	130	1088K	560	1132BMK	561	1162GK	561
142C	26	1048N/D3	130	1092V	134	1132K	561	1162K	561
142C/A	26	1048VN	130	1094V	134	1133	139	1162GBMK	562
142HS	296	1048MQ	291	1095N	134	1133RL	139	1164	142
142K	556	1048BM-HS	297	1096	134	1134	139	1164BM	142
142MC	26	1048INOX	303	1096K	560	1134A	139	1164MQ	292
142MC/SC9I-E	26	1048NK	559	1098	135	1134A/RL	139	1164BMK	562
142SN	26	1048VNK	559	1098PL	135	1134RL	139	1164K	562
142SN/S	26	1050	131	1098K	560	1137BA	312	1166	142
142SN/SC9	26	1051	131	1098PLK	560	1137BA/RC	312	1166BM	142
186	27	1051GM	131	1100BA 600	312	11411	541	1166G	142
187	27	1051L	131	1101	135	11415B	541	1166GBM	142
187/B5	27	1051XL	131	1101R	135	1142BM	139	1166MQ	292
188	27	1052	131	1102	135	11420B	542	1166BM-HS	298
192	27	1052HS	297	1103	135	1142MQ	292	1166BA	312
192/S2	27	1052BA	312	1103R	135	1142BMK	561	1166BMK	562
194	27	1052K	559	1104	135	1143	139	1166GBMK	562
195	27	1053	131	1104R	135	1143R	139	1166GK	562
195/B5	27	1054	131	1105	135	11431	542	1166K	562
195AS	27	1055	131	1105/C10T	136	11435	542	1168	142
195AS/B	27	1055D	131	1105/C16T	136	1144D	139	1168G	142
195K	556	1056	131	1105/C32T	136	1144D/RG	139	1168BM	143
195P	27	1057A	132	1105AD-50	136	1144D/RL	139	1168GBM	143
195P/B5	27	1058	132	1105T20	136	1144G	139	1168MQ	292
1002	128	1059	132	1105T30	136	1144G/RL	140	1168BM-HS	298
1008	128	1060	132	1105T50	136	1144L	140	1168BMK	562
1008BM	128	1061	132	1112	136	1144T	140	1168GBMK	562
1009	128	1062	132	1114	136	11440A	542	1168GK	562
1009L/A	128	1062AL	132	1118	136	11440B	542	1168K	562
1009L/B	128	1062GM	132	1120A	136	11440C	542	1169/D3	143
1009L/C	128	1063	132	1120ARL - ARG	136	11450A	542	1169BM/D3	143
1009L/D	128	1064	133	1122	136	11450B	542	1169G/D3	143
1009L/DP	128	1065F	133	1122 - 1125MOL	137	11450C	542	1169GBM/D3	143
1009L/DP-S2	128	1065P	133	1122K	560	1148A	140	1171BM	143
1010	128	1066	133	1123	137	1148A/R	140	1172BM	143
1010BM	128	1067	133	1123K	560	1148B	140	1172BM/P	143
1010MQ	291	1077	133	1124	137	1148B/R	140	1173BM	144
1031/S4	129	1078	133	1124K	560	1148P	140	1175BM	144
1032	129	1080D	133	1125	137	11488PF	543	1177BM	144

INDEX ALPHANUMÉRIQUE

1177BM/Z	144	1253A	150	1269PZ	155	1294L	158	1366B	164
1178BM	144	1254	150	1269PZ/S4	155	1294HS	298	1366KF	164
1178BM/P	144	1256/C36-2	150	1269N/PZK	564	1294K	564	1366S	164
1182BM	144	1256LP	150	1269PZK	564	1295	158	1366S KIT	164
1183BM	144	1256PE	150	1270BA	312	1295/C14	159	1366S/R1	164
1184BM	145	1256PH	150	1272MQ	292	1297TX	159	1366S/R2	164
1185BM	145	1256PZ	150	1272MQ/S	292	1297TX/D6	159	1366S/R3	164
1186BM	145	1256/20	151	1272MQF	292	1297TX/L	159	1366S/R4	164
1188BM	145	1256/30	151	1272BA	312	1297TX/L-S5	159	1366S/R5	164
1190BM	145	1256RTX	151	1273MQ/D6	292	1297TX/S12	159	1366SL	164
1191BM	145	1256TX	151	1273MQF/D6	292	1298RTX	159	1366ST	164
1191BM/L	145	1257BE	151	1273MQF/E1	573	1298RTX/S8	159	1366S/R10	165
1191R/5-M	145	1257ES	151	1273MQF/E4	573	1298RTXK	564	1366S/R11	165
1200MS	145	1257ESB/S8	151	1274MQ	292	1299N/PZ	159	1366S/R12	165
1201E	146	1257LP	151	1274MQF	292	1299PZ	159	1366S/R13	165
1201E/DZ	146	1257LP/S	151	1274MQ/S	293	1299PZ/S6	159	1366S/R14	165
1201E/S6	146	1257LPH/S8	151	1275MQ/C	293	1299HS	298	1366S/R21	165
1201EN	146	1257PH	151	1276MQ/C	293	1299N/PZK	564	1366S/R22	165
1201E/K	562	1257TX	151	1277BA	312	1299PZK	564	1366S/R24	165
1201EN/K	562	1257TX/S	151	1279MQ	293	1302	160	1366S/R25	165
1202E	147	1260	152	1279MQ/F	293	1303	160	1366S/R26	165
1202E/S4	147	1260/S6	152	1279MQ/S	293	1304	160	1366S/R6	165
1202EL	147	1260N	152	1281BG	155	1305	160	1366S/R7	165
1202EN	147	1260E	153	1281LP	155	1305Z	160	1366S/R8	165
1202E/K	562	1260MC	153	1281PB	155	1306	160	1366S/R9	165
1202EN/K	562	1260EK	563	1281PM	155	1307	160	1367/K10	165
1203E/D	147	1260K	563	1281/B28A	156	1308	160	1367/S4	165
1203E/S	147	1260NK	563	1281BG/A9	156	1310	160	1368	166
1203/E10P	571	1262	153	1281BG/B28NA	156	1312	160	1368G/C2U	166
1203/E1P	571	1262/S4	153	1281BG-TX/A8	156	1314	161	1368G/CV	166
1203/E4P	571	1262E	153	1281LPH	156	1326	161	1368G/K400	166
1203/E5P	571	1262L	153	1281PE	156	1327	161	1368G/OD	166
1204E	147	1262MC	153	1281PH	156	1328	161	1368G/SD	166
1204E/S5	147	1262N	153	1281PZ	156	1329	161	1369/C11	166
1204EL	148	1262EK	563	1281RTX	156	1330	161	1370	166
1204E/K	562	1262K	563	1281TX	156	1331	161	1370/MR...	167
1205E/ES	148	1262NK	563	1290	157	1335BM	161	1370F	167
1205E/ES-S8	148	1263/D...	153	1290/S	157	1337/S5	161	1370F/MR...	167
1206E/BP	148	1263/S12	154	1290N	157	1338	161	1370FT	167
1206E/BP-S7	148	1263MC/D8	154	1290HS	298	1338A - 1338B	161	1370T	167
1207E/TX	148	1263/E74	571	1290INOX	304	1338R9 - 1338R12	161	1370T-HS	298
1207E/TX-D	148	1263/E78	571	1290K	564	1342	161	1370FT-HS	299
1207E TX/K	563	1263/E39	572	1290K/INOX	564	1342PM	161	1370INOX	304
1208E/RTX	148	1263/E40	572	1290NK	564	1342PMR	161	1370BA	312
1208E/RTX-D	148	1263/E50	572	1292	157	1343	161	1370BA/MR	313
1208E RTX/K	563	1263/E62	572	1292/S4	157	1344	162	1370BA/PL	313
1209E/PZ	148	1263/E70	572	1292L	157	1344A/VW	162	1374F	167
1209E/PZ-S4	148	1263/E85	572	1292N	157	1345	162	1374F/MR...	167
1209EN/PZ	148	1264	154	1292HS	298	1351	162	1375	167
1209E PZ/K	563	1264/S5	154	1292INOX	304	1353	162	1375/MR	167
1209EN-PZ/K	563	1264L	154	1292K	564	1357Z/45	162	1375A	167
1229LP	149	1264K	563	1292NK	564	1359T	162	1375B	167
1229LP/S	149	1265ES	154	1292K/INOX	564	1360/K6	162	1375BA/PL	313
1229LPH/A6	149	1265ES/S8	154	1293/D...	158	1360/KP3	162	1376X	167
1229PH	149	1266BP	154	1293/S...	158	1360G	162	1376X/MR	168
1236B	149	1266BP/S8	154	1293BP	158	1361/C12	162	1376XT	168
1238B	149	1267TX	154	1293BP/S	158	1361/K9	162	1376XT/MR	168
1241	149	1267MC/TX	155	1293ES	158	1362B	163	1377	168
1242	149	1267MC/TX-D7	155	1293ES/S7	158	1364SCP	163	1377/MR...	168
1243/D7	149	1267TX/D7	155	1293INOX/D9	304	1364SE	163	1377T	168
1243LP/D6	149	1267TX/S13	155	1293BX/DA	573	1364SP	163	1377INOX	304
1243/S11	150	1267TXK	563	1293BX/DD	573	1364SV	163	1377BA	313
1250	150	1268RTX	155	1293BX/DE	573	1365/K13	163	1377BA/PL	313
1251	150	1268RTX/S8	155	1293BX/DF	573	1365P10	163	1378	168
1252/S5	150	1268RTXK	564	1294	158	1366A	163	1378/MR...	168
1253	150	1269N/PZ	155	1294/S7	158	1366/K5	164	1379F	168

INDEX ALPHANUMÉRIQUE

1379F/MR...	168	1455SVP/R...	173	1467LF/RC	180	1478/3P	185	1488 - 1488L	190
1379BA	313	1457/B4	173	1467T/C6	180	1478/K3	185	1488/1	190
1380	168	1458	173	1467TU	180	1478NSS	185	1488R...	190
1380/MR...	168	1460F	173	1468N	180	1478T	185	1489/31T	190
1380S	168	1461/C5G	173	1470	180	1479	185	1489/33	190
1380S/MR...	168	1461/C6B	173	1470FT	180	1479/B27	185	1489/33P	191
1380T	169	1461/C11A	174	1470PF	180	1479L/S2	185	1489/C14	191
1380BA	313	1461/C12A	174	1471	180	1479LB/C5	185	1489/E	191
1380BA/MR	313	1461/C13B	174	1471A	180	1479L/K4	186	1489/Y	191
1380BA/PL	313	1461/C18B	174	1471CF	181	1479LV/S3	186	1489R	191
1381	169	1461/C20G	174	1471CM	181	1479ML/B17	186	1490	191
1381/MR...	169	1461/C6G	174	1471CM/E11	181	1479ML/S3	186	1490/R1 - 1490/R2	191
1381T	169	1461/C7B	174	1471GF	181	1479N/S5	186	1490F	191
1381BA	313	1461/C8B	174	1471M/50	181	1479RB/1	186	1491	191
1381BA/MR	313	1461/C9B	174	1471M/C22	181	1479RB/2	186	1491A	191
1381BA/PL	313	1461/C21G	175	1471M/P	181	1479RB/3	186	1491R	191
1385	169	1461/C23B	175	1471M/W50	181	1479U/13	186	1491T	191
1385/MR	169	1461/C24B	175	1471PN/B1	181	1479U/32	186	1492/1 - 1492/2	192
1390	169	1461/C25G	175	1471PN/B2	181	1480	186	1492T	192
1390/MR...	169	1461/C27G	175	1471PN/B3	181	1481/C12	186	1493	192
1390N	169	1461/C28B	175	1471PN/B4	181	1481K/S4	187	1493/C30	192
1390NR	169	1461/C29B	175	1471PN/B5	181	1481PL	187	1493/PF	192
1390R	169	1461/C30G	175	1471PT/C5	181	1481PL/S3	187	1493AL	192
1390HS	299	1461/C32G	175	1471D2	182	1481T/C12	187	1493AL 4S	192
1390BA	313	1461/C33B	176	1471T/C5	182	1482	187	1493B	192
1390BA/R	313	1462/KD	176	1472	182	1482/8 - 1482/10	187	1493B/S5	192
1391	169	1462/KI	176	1472AU	182	1482A/1	187	1493/C19	193
1391A	170	1462/KMRC	176	1472AU/P	182	1482A/3	187	1493/C7	193
1392	170	1462/KU	176	1472AU/RP	182	1482A/5	187	1493AL CF	193
1392R	170	1462/MB	176	1472B/RNLT	182	1482B	187	1493DSG	193
1392HS	299	1462CF	176	1472FC	182	1482SN	187	1493FF	193
1393	170	1462CF/C6	176	1472FC/GE	182	1482C	188	1493FT	193
1410/M	170	1462CF-SN	176	1472FC/L	182	1482D	188	1493H	193
1428	170	1462CF-SN/C6	176	1472FCA	182	1483K/12	188	1493HK	193
1428/SB11	170	1462/EI	177	1472R/AU	182	1483K/22	188	1493J	193
1428L	170	1462AD/BSC	177	1472FCL/RP	182	1483KV-PT/S7	188	1493VW	193
1428L/B3	170	1462AD/SMN	177	1472H	183	1484	188	1493/S-U	194
1429	171	1462PIM	177	1472MT/VW	183	1484PSA	188	1493C/ADB	194
1429/SB7	171	1463/KIT	177	1472TM	183	1485BP	188	1493U/ADB	194
1430/...	171	1464CBD	177	1472VW	183	1485BPM	188	1493X	194
1430/S	171	1464IC	177	1473	183	1485FCA/K2	188	1493Y	194
1431/...	171	1464T	177	1473A	183	1485FCA/T	188	1494	194
1431/C5	171	1464T/SP80	177	1473FN	183	1485FCA/TS	188	1494BMW	194
1433	171	1464ADB	178	1473P	183	1485FRD/T	188	1494E	194
1433/C11	171	1464AP	178	1473T	183	1485KIT	189	1494FPC	194
1435	171	1464AP T	178	1474/C4	183	1485MJ	189	1494MAN	194
1435/1	171	1464AP T16X12	178	1474E/VW	183	1485MRC/T	189	1494MRC	194
1435/1R	171	1464APB	178	1474E/VW2	183	1485PMTJ	189	1494T/C5	194
1435R	171	1464FAP	178	1474DL	184	1485R	189	1494VW	194
1437/C12	172	1464FG	178	1474G	184	1485R/P10	189	1494/C14A	195
1438	172	1464FG/CP4	178	1474L	184	1485R/P17	189	1494M	195
1438DCT	172	1464IC/RK	178	1475U	184	1485TC	189	1494Q	195
1438DCT/S	172	1464PB	178	1476	184	1485VAG	189	1494T	195
1438DSG	172	1464PF	179	1476/RC	184	1485VAG/K2	189	1494VW/K	195
1438EVO	172	1464PT	179	1476A	184	1485VLV/T	189	1494VW/KT	195
1438K/DSG-2	172	1464TDI	179	1476A/RC	184	1486/10	189	1494XZN	195
1438K/PWR	172	1464VD	179	1476C/1	184	1486/20	190	1495/C6	195
1438R	172	1465	179	1476GT	184	1486/30	190	1495M	195
1439/K7	172	1466/C5	179	1476PSA	184	1486/40	190	1495T	195
1440/...	173	1466L 11	179	1476T	184	1486/50	190	1496/C	195
1445/1 - 1445/2	173	1466TLF	179	1477/C10	184	1486/60	190	1497D	195
1452K	173	1467	179	1477D	185	1486/70	190	1497/C23	196
1452PN/K	173	1467/RK1	180	1477D/S5	185	1486/80	190	1497/C94	196
1454P	173	1467/RK2	180	1477K/7	185	1486/90	190	1497/S3	196
1455SVP	173	1467LF/2	180	1478	185	1487/K2	190	1497BS	196

INDEX ALPHANUMÉRIQUE

1497KB/S3	196	1529	205	1585GI/5 - 6 - 7	211	1654	214	1700N	220
1497P	196	1529/C7	205	1589PI/50 - 100 - 150	211	1654DGT	214	1700N/PM	220
1497RC	196	1529/PG	205	1589VI	211	1656	214	1701N	220
1497SS	196	1529PI	205	1590	212	1657DGT/2	214	1701N/PM	220
1497TE	196	1530/C16	205	1591	212	1658/...	214	1701NE/...	220
1498	196	1530/C5	205	1593	212	1658/C4	214	1701PMR	220
1498BC/12	197	1531/C7	206	1594	212	1658DGTB	214	1701BA	314
1498LT/12	197	1532	206	1595	212	1658SP/1	215	1702N	220
1498LT/12-R7	197	1533/...	206	1599B	212	1659	215	1702N/PM	220
1498LT/12-SF	197	1533PR/1 - 2 - 3	206	1599F	212	1662/1 - 1662/2	215	1702PMR	220
1498MN/12-C	197	1534/...	206	1599GI	212	1662AN	215	1703BA/A	314
1498MN/12-P	197	1535/C...	206	1599GR	212	1662DGT/A	215	1703BA/P	314
1498MN/12-R	197	1539	206	1599P	212	1662SP0	215	1703BA/PL	314
1498MN/12-U	197	1540	206	1599T	212	1662SP2	215	1704	221
1498/12	198	1542/1 - 1542/2	207	1599G	213	1666	215	1704A	221
1498/12-24 R20	198	1544/...	207	1600Q 10	213	1666A	215	1704C	221
1498/24	198	1545/C5M	207	1600Q 8	213	1668	215	1705	221
1498/2A	198	1547/C6	207	1601/PC	544	1668A	216	1705PT	221
1498/4A	198	1547KP	207	1602A-HS	299	1670	216	1706DGT	221
1498B12/R02	198	1547P	207	1602BA	314	1670A	216	1707	221
1498LT/12-24	198	1547PC/2	207	1602/C10	544	1672	216	1707A/1 - 2 - 3	221
1498SA/2A-4A	198	1547PL/2	207	1602A	545	1672A	216	1708/8 - 13 - 20	221
1498/16A	199	1549	207	1603	544	1674A	216	1708HS/21	299
1498/25A	199	1550U	208	1603A	545	1676	216	1709/10 - 1709/18	221
1498/2A-8A-PR	199	1550U/CGS-R	208	1603B	545	1678/C3	216	1710	221
1498/4A-8A CO	199	1550U/M	208	1603BK	565	1679	216	1712E/1 - 2 - 3	221
1498/4A-8A CP	199	1550U/MRC-ABE	208	1603K	565	1679/PR	216	1712TF	221
1498/8A	199	1550U/MRC-C	208	1604	545	1680	216	1713M	222
1498/120A	200	1550U/S...	208	1606/3	545	1680A	217	1714	222
1498/40A	200	1550U/SS187	208	1606A	545	1680B	217	1715	222
1498SM	200	1551/C20	208	1606A/C10	545	1680C	217	1715B/R5L	222
1498SM-A	200	1552/C9	208	1606T	545	1682	217	1715FL/A	222
1498SM-C	200	1555/Q	209	1607	545	1682HS	299	1715FL/B	222
1498SM-CP	200	1555/QS	209	1608	545	1683	217	1715R/FL	222
1498TB/6-12	200	1555C	209	1608/C10	546	1685/C7	217	1716A	222
1498PC	201	1555S/BMW-RNT	209	1608A	546	1687/S4	217	1716P	222
1498ST/TB	201	1556/1A	209	1609A	546	1687A	217	1716Q	222
1498ST/TB ROT	201	1556/2A	209	1609B	546	1687AC	217	1716R	222
1498TB/12-24	201	1557	209	1609C/C6	546	1687D	217	1716U	222
1498TC	201	1557/S3	209	1609M	546	1687U	217	1717A	222
1499	201	1557V	209	1610	546	1688	217	1717B	222
1500/...	201	1558/C4	130	1610-B	548	1688A	217	1717C	222
1500/SP	201	1558/C13	209	1614-P	548	1688M	218	1717D	222
1500G/...	201	1558P	209	1616-SM	548	1688PC	218	1717T	222
1500N/...	202	1559	210	1618-SF	548	1688PC/R	218	1717T RS	222
1500N/G...	202	1559V/8T	210	1620-M	548	1690F	218	1717T RT	222
1500N/SP	202	1560/2	210	1622-F	548	1690L	218	1717V	223
1501/1 - 2 - 3	202	1560A	210	1624-FI	548	1691BM	218	1717V R	223
1501G/1 - 2 - 3	202	1561/...	210	1628-C	548	1691MG	218	1717BA	314
1501Z/S - P - R	202	1562D	210	1630-CR	548	1692	218	1717BA/1	314
1502/...	202	1563/C4	210	1632-TS	548	1692HS	299	1718A...M	223
1505V	202	1565/1 - 2 - 3	210	1634-TD	548	1693	218	1718A...P	223
1505/C5	203	1566/GO1	210	1635-D	549	1693M	218	1718A...Q	223
1506	203	1566N	210	1635-S	549	1694/L	219	1718A...R	223
1508/1 - 1508/2	203	1566P	210	1638M	553	1694A/L	219	1718A...T	223
1511/1 - 2 - 3	203	1566R	210	1639S	546	1694B/L	219	1718D...M	223
1515/1 - 2 - 3	203	1567	210	1639EAB	553	1695XS	219	1718D...P	223
1516/1 - 2 - 3	203	1568	211	1639ESB	553	1696	219	1718D...Q	223
1517	203	1569/F	211	1639ESC	553	1696A	219	1718D...R	223
1517C/...	204	1569/SB	211	1639ETA	553	1696B	219	1718D...S5	223
1518/...	204	1569CP	211	1650	213	1696D	219	1718D...T	223
1518U/...	204	1570/3	211	1650FD	213	1696S	219	1718A...S5	224
1519/...	204	1580/8I	211	1650FT	213	1697	220	1719BMA...M	224
1520/1 - 1520/2	205	1580GL	211	1651DGTTB	213	1699L	220	1719BMA...P	224
1521/1 - 1521/2	205	1585/5I - 6I - 7I	211	1651DGTTB/IP	214	1699L/1	220	1719BMA...Q	224
1528	205			1652	214	1699Q	220	1719BMA...R	224

INDEX ALPHANUMÉRIQUE

1719BMA...T	224	1742KR	228	1757A	231	1767PMC	239	1833RB-L/USB	243
1719BMD...M	224	1742R-A/M...	228	1758	231	1767PMR	239	1833XS/1	243
1719BMD...P	224	1742R-AL/M...	228	1758ADB-D	231	1768	239	1833XS/2	243
1719BMD...Q	224	1742A/C	229	1758A	232	1770	239	1833L	244
1719BMD...R	224	1742A/KR	229	1758ADB-45°	232	1770A	240	1833M	244
1719BMD...T	224	1743HS	299	1758B	232	1770BM	240	1833S	244
1719BMX...M	224	1743T	552	1758B/K5	232	1770RL	240	1833XL	244
1719BMX...P	224	1744	552	1758B-1,6	232	1771	240	1834RR	244
1719BMX...Q	224	1748-BV3	549	1758B-RNT	232	1771BM	240	1836AW	244
1719BMX...T	224	1748N	549	1758LG	232	1771HD	240	1836B	244
1719BM/RL	225	1748V	549	1758M	232	1771RL	240	1837F	244
1719BM/RR	225	1748-BL	550	1758R	232	1772H	240	1837F/USB	244
1719BMA...B5	225	1748-BV1	550	1758VT	232	1772M	240	1837C	245
1719BMA...S5	225	1748-BX	550	1758VT/L	233	1772R	240	1837M	245
1719BMB/P	225	1748-N2D	550	1758BA	314	1772RL/2	240	1837RB-F/USB	245
1719BMC	225	1748-NL	550	1759	233	1772H-HS	300	1837S	245
1719BMD...B5	225	1748-UL	550	1759A	233	1773A	240	1838FLASH	245
1719BMD...S5	225	1748-BA2	551	1759B	233	1773RL	240	1838POCKET	245
1719BMR	225	1748-BH	551	1759HD/3	233	1774	240	1838RB/FLASH	245
1719BMX...R	225	1748-BP	551	1759HD/RR	233	1774A	240	1838/11LED	246
1719BMX...S5	225	1748-BR	551	1759HD/TRUCK	233	1774A/RL	240	1838AM	246
1719R/...	225	1748-BT	551	1759LR	233	1774S	240	1838COB	246
1719BA12	314	1748-BT2	551	1759TT	233	1776BA	314	1838P	246
1719BA8	314	1748-BT3	551	1760DGT	234	1777BM	241	1838RA/10-11LED	246
1720/...	225	1748-NA2	551	1760DGT/2	234	1777BMT	241	1838RB/10LED	246
1720/B	225	1748-BA3	552	1760/OHM	235	1777T	241	1838RR/11LED	246
1720/S	225	1748-BV	552	1760/RMS	235	1777MQ/C	293	1838RV/11LED	246
1720D/...	226	1748-NA3	552	1760B	235	1777MQ/U	293	1838SLIM	246
1720D/B	226	1748-NV	552	1760PA/80	235	1777RL/U	293	1838E	247
1721/B6	226	1748-S	552	1760PA/AC	235	1778AN	241	1838E-BT	247
1723	226	1748-SC	552	1760S	235	1778AX	241	1838SW	247
1725	226	1748-N	553	1760/RSE	236	1778CM	241	1838UV	247
1725CR	226	1748-ST	553	1760/TC2	236	1778M7	241	1839/R1	247
1725MQ	293	1749	229	1760DGT-R3	236	1778P	241	1839/R2	247
1726	226	1749A	229	1760K	236	1778SCL	241	1839/R4	247
1726BM	226	1749A/RB	229	1760PA/AC-DC	236	1778SOS	241	1839/R5	247
1727	226	1749A/RT	229	1760PA/AC-DC2000	236	1778V18	241	1839/R6	247
1727BM	226	1749AC	229	1760R/TC2	236	1778X	241	1839BRW	247
1727HS	299	1750	229	1760/IR1000	237	1778MT	242	1840BM	248
1727BA	314	1750CG	229	1760/IR1600	237	1778SOS-HS	300	1842LED/ABM	248
1728...	226	1750R/1 - 1750R/2	229	1760/IR500	237	1781	242	1842LED/BM	248
1728BA	314	1750RC	229	1760LX	237	1783	242	1842	249
1729CG	226	1750RP/1 - 1750RP/2	229	1760PT	237	1784	242	1843	249
1729DM 450	226	1750RT	229	1760TMC	237	1784BA	314	1844	249
1730	226	1750KG10	230	1760WWM	238	1800/100	242	1844SCK	249
1730M	226	1750M	230	1760BHS	299	1808	253	1845	249
1730V 38	226	1750M3	230	1761	238	1812 150	253	1846	249
1730INOX	304	1750TA	230	1761RS/1	238	1814M	253	1846R-LED/BM	249
1736A	227	1750TLA	230	1762	238	1820	253	1847	250
1737	227	1750HS	299	1762K	566	1820 60	253	1848	250
1737AC	227	1751N	230	1763	238	1820 80	253	1850D	250
1737B	227	1751NR	230	1763G/S500	238	1822	253	1850E	250
1737NX	227	1752	230	1764/K5	238	1822 180	253	1851VK	250
1737BA	314	1752R	230	1765/C24	238	1822 320	253	1851VK-12C	250
1738	227	1753	230	1766	238	1823 60	253	1851VK-12V	250
1739B	227	1753R	230	1766/8	238	1823R/60	253	1852R1750	250
1740A	227	1754	231	1766A	238	1824R	253	1852S-CC	250
1740B	227	1755	231	1766ER	239	1825B	253	1852S-CNT	250
1741B	227	1756	231	1766ER/VW	239	1827	253	1852 S-PIATTE	251
1741B/C5	228	1756B	231	1766G	239	1827PC	253	1852S-F	251
1741BP	228	1756C	231	1766I	239	1827PCL	253	1852S-FLESS	251
1741RV...K	228	1756C-2OR	231	1766L	239	1827/K	254	1852S-KR/CNT	251
1741U	228	1756D	231	1766LI	239	1827F	254	1852S-L	251
1742	228	1756D-2OR	231	1766T	239	1827PFL	254	1860BH R/CM	254
1742/C4	228	1756G	231	1767A	239	1830T	254	1860BH R/CS	254
1742A	228	1757	231	1767B	239	1833L/USB	243	1860BH/120A	254

INDEX ALPHANUMÉRIQUE

1860BH/160A	254	1885/C2-R7	262	1919F1/2	340	1935F	329	1949DGT/2	336
1860BH/200A	254	1885/C3	262	1919F1/4	340	1936/4A	329	1949F2	336
1860BHT R/CM	255	1885/C3-R1	262	1919F3/8	340	1936/5A	329	1949GPA	336
1860BHT R/CS	255	1885/C3-R10	262	1919L	340	1936/7A	329	1949GPN	336
1860BHT/160A	255	1885/C3-R2	262	1919ML	340	1937	329	1949M	336
1860DM	255	1885/C3-R3	262	1919RB-F	340	1937KC	329	1949R	336
1860EI	255	1885/C3-R4	262	1919RB-FE1/4	340	1937R/P	329	1949T	336
1860M	255	1885/C3-R5	262	1919RF-F	340	1937C...	330	1950BZK	336
1860PMIG	255	1885/C3-R6	262	1919RF-FE1/4	340	1937K...	330	1951	337
1860RG	255	1885/C3-R7	262	1919RM-F	340	1937KL	330	1951A	337
1860SQ	255	1885/C3-R8	262	1919RM-FE1/4	340	1937KL-D	330	1952	337
1870	256	1885/C3-R9	262	1919SC	340	1937M	330	1957 115-750W	316
1870I	256	1885/XC60	262	1921B1	321	1937M-01÷11	330	1957 125-1400W	317
1870-20/5S	257	1889	260	1921M1	321	1937N10	330	1957 230-2400W	317
1870-72 /FC	257	1889CF	260	1921M2	321	1937N10-GR	330	1972/13	315
1870-72/FL	257	1893/134A	262	1921N3	321	1937N20	330	1984/18QM	315
1872L	256	1893/1234YF	263	1922P1	321	1937N20-GR	331	1995MQ/G1 - G2	293
1872L 35/5S	257	1893TR/1234YF	263	1922P2	321	1938	331	1995MQ/T	293
1872L 35/FC	257	1893TR/134A	263	1922P3	321	1938R/L	331	1996MQ/GM	293
1873	256	1893TR/CI	263	1924F	321	1938R/S5	331	1996MQ/T	293
1873-30/5S	257	1895 13	263	1924B	322	1940	331	1996SVG	293
1874	257	1895 6	263	1924CD	322	1940/C6	331	11001H	529
1874-50/5S	257	1895/S	263	1924XM	322	1940/S5	331	11002	529
1874-50/FC	257	1895G	263	1927B	322	1940E10	331	11003	529
1875LT	257	1895 27	264	1927B/K5	322	1940MT	331	11011	529
1875SP/K3	257	1895/RC	264	1927CD	322	1940S...	331	11011H	529
1877	257	1897	264	1927CD/K3	323	1940E10/MT	332	11018	529
1877A	258	1897/CRB	264	1927P	323	1940E10/S...	332	11019	530
1877F	258	1897/G	264	1927P/K3	323	1940E10/S5	332	11021	530
1878 2	258	1897/MV	264	1927PAL	323	1942A	332	11023	530
1878 3	258	1898/B	264	1927XM	323	1942LR	332	11024	530
1878 4	258	1898/K40	264	1927XM/K5	323	1944A	332	11031÷11039	530
1878 8	258	1898/D	265	1927AN	324	1944AR 2	332	11032	530
1878 11	259	1898/M	265	1927G	324	1944N	332	11034	530
1878 30	259	1898/S	265	1927SP-AM	324	1944PA	332	11035	530
1879	259	1899A	265	1928CD	324	1945S	332	11037	530
1879 6	259	1899SI	265	1928DA	324	1945S/G...	332	11038	530
1879/FUEL	259	1900M 8X15 - 1900M	337	1928DAL	324	1945C	333	11040	531
1879R/K4	259	10X15		1928XM	324	1945C/G...	333	11045	531
1880	259	1900S 8x10	337	1928K4	325	1945C/GP...	333	11046	531
1880ADB	259	1914	337	1930A	325	1945P	333	11048	531
1881	259	1915B	337	1930CD	325	1945P/S...	333	11049	531
1882	259	1915C	338	1930LA	325	1946C4,8	333	11050	531
1883	259	1915C/L	338	1930LH	325	1946T	333	11069	531
1883NC	259	1915D	338	1930PA	325	1946C/T...	334	11100	532
1884	260	1915E	338	1930HLA	326	1946C7,8	334	11101	532
1884/C12	260	1915E/XL	338	1930ZL	326	1946KF	334	11102	532
1884N/C8	260	1916G	338	1931AN10	326	1946KF/M...	334	11105	532
1885	260	1916GF	338	1931CD10	326	1947	334	11106	532
1885/C1	261	1916GFE	338	1931CD13	326	1947G	334	11107	533
1885/C1-R1	261	1916I	338	1931CD6	326	1947G2	334	11110	533
1885/C1-R2	261	1916JF	338	1932B10	327	1947H	334	11111	533
1885/C1-R3	261	1916JM	338	1932B13	327	1948	335	11115	533
1885/C1-R4	261	1916P	338	1932RS13	327	1948PR	335	11116	533
1885/C1-R5	261	1916S	339	1933	327	1949BC	335	11120	533
1885/C1-R6	261	1917F	339	1933AN90-H	327	1949BC/RU	335	11121	534
1885/C1-R7	261	1917JF	339	1933IH	327	1949P	335	11125	534
1885/C1-R8	261	1917JM	339	1933ILH	327	1949U5	335	1112K	560
1885/C2	261	1917M	339	1933AN90	328	1949U5/A	335	11130	534
1885/C2-R1	261	1917RG	339	1933I	328	1949U5/B	335	11131	534
1885/C2-R2	261	1917SP	339	1933IL	328	1949U5/C	335	11132	534
1885/C2-R3	261	1917ST	339	1933L	328	1949U5/D	335	11135	534
1885/C2-R4	261	1918	339	1934BV	328	1949U5/E	335	11140	535
1885/C2-R5	261	1918N	339	1934MAV	328	1949U5/F	335	11141	535
1885/C2-R6	261	1918R	339	1934MAV70	328	1949U5/G	335	11145	535
		1919FE1/4	339						

INDEX ALPHANUMÉRIQUE

11200A	535	2002/BV13	344	31BM/D6	9	345SB2	31	3000L	266
11200B	535	2002/BV42	344	31L	10	345SC	31	3000L/RLS	266
11202A	535	2005MPU	344	31SE	10	345SI	31	3000M/PLM	371
11202B	535	2005PA/D	344	32	10	345SI/R	31	3002	266
11202C	535	2005PA/E	344	32AU	10	345U	31	3002/RLS	266
11204A	536	2005PA/S	344	32AUR	10	345U/A	31	3003	267
11204B	536	2009ID	344	32BA	306	349	31	3003/RLS	267
11204C	536	2009N/BV	344	34	10	349/SMAS	31	3003C	267
11208A	536	2028/VV	344	34BA	306	349/SMM	31	3003C/RLS	267
11208B	536	2028E	344	34INOX	302	350	32	3003PRO	267
11210A	536	2029/VV	345	35	10	351C	32	3003PRO/PM	267
11210B	536	2029E	345	35HS	294	351P	32	3003PRO/RCR	267
11210C	536	2032/TE	345	35PM	10	352C/U	32	3003PRO/RRG	267
11212A	536	2032/TV	345	35PMR	10	352U	32	3003PRO/RT	267
11212B	536	2033L	345	36	10	353N	32	3003PRO/SP	267
11214A	537	2033L/VV	345	37	10	353N/C6	32	3004	267
11214B	537	2036/TV	345	37PM	10	353NM	32	3006	268
11214C	537	2036E	345	37PMR	10	355	32	3006 R/RG	268
11216A	537	2037/TV	345	38/DS1	570	357F3	32	3006 R/RGF	268
11216B	537	2038/TV	346	38/DS2	570	357R/F3	32	3007	268
11216C	537	2041UC	346	39BA	307	358	33	3007 R/RG	268
11218A	537	2051N	346	39INOX	302	358RL	33	3007 R/RGF	268
11218B	537	2055HB	346	310	27	359	33	3008	268
11220A	537	2080/VG	265	310/C4	28	359CH	33	3009	268
11220B	537	2080/V6	346	310/C8	28	360	33	3009R/GR4	269
11220C	537	2080/V6-U	346	310B	27	360HS	296	3010/T...	269
11223	538	2080/D10	347	311	28	360R/...	33	3010H	269
11230A	538	2080/V12	347	330	28	361N	33	3010V	269
11230B	538	2080/V12-...	347	330BA	309	362	33	3011/T	269
11232A	538	2115P L-MQ32	291	330BA/2R	309	362INOX	303	3012	269
11234A	538	2115PI/BIKE-HOME	350	330R/A	28	362R/...	33	3012C	269
11234B	538	2250-O	265	330R/I	28	363	33	3012I	269
11240A	539	2252	265	331C	28	363BA	309	3014	270
11240B	539	2252KR4	265	332	29	363R/...	33	3014 SAR	270
11242A	539	2254A	266	334	29	365	33	3014R/GR5	270
11242B	539	2254C	266	334R	29	365R/...	33	3014SAR/1	270
11246A	539	2254F	266	334R/I	29	366	33	3014SAR/2	270
11248A	539	2254K	266	336	29	374	34	3014SAR/RR	270
11248B	539	2254SM	266	338	29	374K	556	3023	270
11259	539	2254T	266	338R	29	374R/...	34	3025	270
11260	540	2258-O	266	338R/I	29	375	34	3025/PF	270
11263	540	2300ST/KIT	359	338RP	29	376	34	3025/RF	270
11264	540	2400 RSC24/PC	365	339A	29	378	34	3025/RG	270
11265	540	2400 RSC24/PD	365	339A/R	29	378BA	309	3026 0,3	270
11266	540	2400 RSC24/PF	365	340	29	383	34	3026 0,5	271
11268	540	2400 RSC24/PF-	365	340C	30	383R	34	3026 1,0	271
11271A	540	2400 RSC24/PL	365	340C/KRL	30	384	34	3026/R 1,0	271
11271B	540	2400 RSC24/SPC	365	340RL	29	384RC	34	3026/R0,3	271
11271C	540	2400 RSC24/MP	366	341	30	386A/RC	34	3026/R0,5	271
11276A	540	2400-COVER RSC24	381	341B	30	386A	35	3026/S	271
11276B	540	2400-COVER	381	341B/RL	30	386BA	309	3026/SA	271
11276C	540	RSC24AXL		341B/RM	30	387	34	3026/SAM	271
		2499PC	366	341RL	30	387R	34	3026/SP	271
		2499PF	366	342	30	388	34	3027 10	271
		2499PF/M	366	342A	30	388A	34	3027 20	271
2001/B26	342			342A/MOL	30	388C/C8	34	3027 100	272
2001/BV	342			342A/RL	30	389/K4	35	3027 30	272
2001/BZV	342			342MOL	30	392C	35	3027 50	272
2001/BZ24 MQ	343	30	9	342P	30	392RG/C	35	3027/KP	272
2001/BZ27 VU	343	30BA	306	342P/RL	30	393	35	3027/KPP50	272
2002/BV12	343	31	9	342RL	30	395	35	3027/PR	272
2002/BV6	343	31/B6N-LSE	10	345	31	395T	35	3028 20	272
2002/BV7-ZIP	343	31/B6N	9	345C	31	398	35	3028SP/20	272
2002/BV8	343	31BA	306	345SB	31	399	35	3028 30	273
2002/BV9	343	31BA/C	306	345SB/R	31	399R/...	35	3028 50	273
2002/BVL6	343	31BM	9					3028SP/30	273

2

3

INDEX ALPHANUMÉRIQUE

3028SP/50	273	3092	281	3992	286	420A	41	437K/12	47
3029/2T	273	3093/E	281	4		420B	41	437K/16	47
3029/2T-L/R5	273	3093/U	281			421	41	437K/33	47
3029/2T-L/R6	273	3094PA	281	42	11	421/SP6	41	437P	46
3029/2T-L/RP	273	3095	281	42/B	10	422	41	437U/09	47
3029L/2T	273	3099E	281	42/B9N	11	423	41	437U/E-M...	47
3030/2T	273	3099T	281	42/S	11	423A	41	437U/PM	47
3030/2T-R5	273	3500/P-M	373	42/SC9I-E	12	424	41	438...	47
3030/2T-R6	273	3700/PC	376	42/SP25	12	424/SP	41	438A	47
3030/2TRP	274	3700/PF	376	42AS	12	425	42	440	47
3030H/2T	274	3700/PFL	376	42AS/B9N	12	425/SP	42	440A	48
3033/3T	274	3700/PLA	376	42AS/S	12	426	42	440ASC	48
3033E/3T	274	3700/PLL	376	42BA	307	426/SP	42	440ASF	48
3033S 3T/R2	274	3700-COVER C37	381	42BA-AS	307	426MD-3/CP3	42	440ASG	48
3035	274	3910	283	42HS/AS	294	426MD-3/CT3	42	440ASW	48
3036	274	3912PP	283	42INOX	302	426MD-3/F3	42	440B	48
3040C	277	3912TP	283	42INOX/S	302	426MD-3/FA3	42	441	48
3040C/S1	277	3912TP/A	283	42INOX/SC10	302	426MD-3/OG3	42	441A	48
3040C/S2	277	3912TP/C	283	42INOX-AS	302	426MD/CP	43	441B	49
3041C	277	3912TP/FOX	283	42INOX-AS/S10	302	426MD/CT	43	442	49
3041C/12	277	3912TP/QRE	283	42LMP	13	426MD/F	43	443	49
3041C/16	277	3912TP/ROAD	283	42LMP/S	13	426MD/FA	43	444	49
3042C	277	3912TP/RS	283	42MP	12	426MD/OG	43	444G	49
3043C	277	3912TP/ST	283	42MP/B9N	12	426MD/OV	43	446/C30	49
3043C/ 41÷47	277	3916MMP	284	42MP/S	12	426MD/S	43	446/C48	49
3047C	277	3918MML	284	42NEVHS	294	426MD/SP10	43	446/C110	50
3048C	277	3921	284	42NEWK	555	426MD/T	43	446ASC/C37	50
3050/CC	277	3923	284	42SLIM	13	426MD/TA	43	446ASF/C29	50
3050/600	278	3927	284	42SLIM/B8NI-E	13	426MD-3/A9	43	446ASG/C23	50
3050/KA	278	3932U	284	42SLIM/S11	13	426MD-3/OV3	43	446ASW/C36	50
3050/LA	278	3935	284	45	13	426MD-3/S3	43	447/C37	51
3050/MS	278	3937	284	410	36	426MD-3/T3	43	447/C53	51
3050/MV	278	3948	284	410/SP	36	426MD-3/TA3	43	447/C70	51
3054	278	3952	284	410/SEL	37	426SB	42	450	51
3055M	278	3952/S	284	410A	37	426SB/SP	42	450/C13	52
3057	278	3953	284	410AS	37	426T	42	450/C15	52
3061/2T	274	3955	284	410AS/SEL	37	426T/SP	42	450/C21	52
3061/2T-P100	274	3961 3,2	284	410AS/SP	37	427	44	450/C9	52
3061/2T-P50	274	3961 3,3	284	410MIX/SEL19	37	428/C14	44	450AD	51
3065/20-10T	275	3961 3,5	285	412	37	428FC	44	450AL	51
3065/40-20T	275	3961U	285	412/SP	37	428FP	44	450PA/1	52
3067/60-15T	275	3962MV	285	412/C150	38	429/C14	44	450PA/2	52
3067/70-13T	275	3962SH	285	412/SP91	38	429FC	44	450PR	52
3070B	278	3963P	285	412A	38	429FP	44	451	52
3070B/10	279	3964	285	412C	38	430	44	451GA	53
3070BE/B	279	3965	285	412L	38	430/SP	44	451PA	53
3070BE/F	279	3965C	285	412XL	38	430ASC	45	451PR	53
3070BE/K	279	3967	285	414	38	430ASW	45	452	53
3070BE/S	279	3969	285	414/C116	39	431	45	452GA	53
3071A	279	3969K3	285	414/SP	39	431/SP	45	460	53
3071B	279	3971	285	415	39	433	45	460G	53
3071RS	279	3972	285	415/C116	39	433ASF	45	460PP	53
3072N	280	3973/1	285	415/SP	39	433ASG	45	4900-COVER C49	385
3073	280	3973/2	285	415/SP91	39	434	45	5	
3075/CM	280	3973PF	285	415CO	39	435	46	52	13
3075/K10	280	3973/3	286	415CO-A	39	435G	46	52MQ	289
3075A	280	3973/4	286	415C	40	436	46	53	13
3075B 55	280	3975	286	415CO/SP	40	436L	46	55	13
3075MV	280	3984/1	286	415L	40	436R	46	55/B12N	14
3079/21	280	3984/2	286	416	40	437C	46	55/B8N	14
3080/C15	280	3984/3	286	416/SP19	40	437C/...	46	55/S	14
3080R/CS3	280	3984/4	286	417	40	437C/RM14	46	55/SP	14
3081	280	3984/5	286	417/SP	40	437K/8	46	55AS	14
3085	280	3984/6	286	419	40	437K/9	46	55AS	14
3091	281	3991	286	419T	41	437K/10	47	55AS/S	14

INDEX ALPHANUMÉRIQUE

55BA	307	5915VU/AS	463	667N	67	6600 M/424	579	720AS	72
55BA-AS	307	5927VU/M	463	668N	67	6600 M/427	579	720B	72
55HS	295	5935VI/2MB	449	668RG	67	6600 M/430	579	720FRD	73
55K	555	5935ET/1MB	472	668RGC	67	6600 M/440	579	720FTX	73
55MP	14	5935VG/1MB	488	669N	68	6600 M/456	579	720FTX/SB	73
55MP/S	14	5938U/2T	464	671B/C10	68	6600 M/465	579	720IC	73
58	14	5940SBK	488	671B/C5	68	6600 M/480	579	720LS	123
58BA	307	5941VU/M	489	671N/C10	68	6600 M/485	579	720L	72
58BA-AS	307	5945VUM	490	671N/C20	68	6600 M/510	580	720L/S3	72
560/C12	55	5954VI	451	671N/C30	68	6600 M/532	580	720LC	72
560/C2	55	5954VG	491	674/C	69	6600 M/534	580	720LC/C3	72
560/C3	55	5957VI	450	677	69	6600 M/542	580	720LC/PM5	72
560/C3PLUS	55	5957U-P	465	677/C	69	6600 M/548	580	720LC/S5	72
560/C4+	55	5957VG	492	677/CP200	69	6600 M/561	580	720LCL	73
560/C6	55	5958U	466	677/CV - 678/CV	69	6600 M/583	580	720LCL/C3	73
561/1	55	5980U/BIKE	468	678/C	69	6600 M/643	580	720MC	71
562-1/VA - 562-2/VA	56	5980ET/A	473	680TC	70	6600 M/650	580	720MC/C13	71
562VV-A	56	5980/MQ	474	682	70	6600 M/657	580	720ME	73
564-3R/V - 564-4R/V	56	5980ET/B	474	6200M/B	629	6600 M/658	580	720ME/C8	73
565-1R/VA - 565-2R/VA - 565-3R/VA	56	5980EL/A	475	6200AP/S10	630	6600 M/716	581	720MRC	73
565-4R/VB	56	5980EL/B	476	6600 M/14	575	6600 M/813	581	720S	72
565-5R/VB	56	5980ID	477	6600 M/22	575	6600 M/842	581	720S/SB6	72
565VV-B	56	5988U/7M	459	6600 M/27	575	6600 M/852	581	720TC	73
567-4R/VB	56	5988H/7M	469	6600 M/29	575	6600 M/856	581	720TC/S5	73
567-5R/VB	56	5988L/4M	470	6600 M/33	575	6600 M/857	581	720TX	73
581	60	5988U/6M	471	6600 M/40	576	6600 M/871	581	720TX/C6	73
583	60	5988 VHB-MQ	475	6600 M/42	576	6600 M/878	581	720XZN	74
583/C31	60	5990V1	467	6600 M/44	576	6600 M/881	581	727/ES16	74
590 - 592	60	5990V3	467	6600 M/47	576	6800 VE	575	727/ES16TX	74
594	60	6		6600 M/51	576	6800BA	630	727/IC16	75
596 - 598	60			6600 M/52	576	6800RS	630	727/ES22	75
599DGT	61	600	61	6600 M/58	576	6888B1/2	568	727/ES22TX	75
599DGT-AN	61	601C	61	6600 M/59	576	6888B1/4	568	727/ES32	75
5700LAMP	393	601CA	61	6600 M/61	576	6888B3/8	568	727PI/16	74
5902VI	443	603	62	6600 M/62	576	6888	575	727PI/16 1/2	74
5902MT	477	604B	62	6600 M/63	576	6888GS	630	727PI/22	75
5902MT/AS	478	605E	62	6600 M/73	576	6888GW	630	727PI/32	75
5904VI/1T	443	606MQ/50	289	6600 M/112	577	7		728	75
5904VI/2T	444	610/5	62	6600 M/116	577			728/C10	75
5904VI/3T	445	610L/5	62	6600 M/120	577	73	15	728/15	76
5904VU/1M	452	610L/5L	62	6600 M/125	577	73/B13N	15	728/16	76
5904VU/2M	453	611	62	6600 M/126	577	73/S	15	728/21	76
5904VU/2T	454	612 ÷ 614	62	6600 M/131	577	78	15	728/22	76
5904VU/3T	455	614/50	62	6600 M/174	577	78AS	15	728/22L	76
5904VU/4T	456	615	63	6600 M/175	577	78BA	307	728/25	76
5904VG/2M	479	616 - 617 - 619	63	6600 M/217	577	78BA-AS	308	728/OR - 728/SP	76
5904VG/2T	480	621	63	6600 M/218	577	710	70	728AS	75
5904VG/3	481	622	63	6600 M/222	577	710/16	70	728B	76
5904VG/3T	482	641	63	6600 M/223	577	710/20	70	728FTX	75
5904VG/5T	483	642	63	6600 M/230	578	710/C10	70	728L	76
5905VG/1	484	643	63	6600 M/236	578	710/21	71	728L/S	76
5905VG/2	485	644	63	6600 M/241	578	710/22	71	728LQ	76
5908VI/2T	446	650A	63	6600 M/242	578	710/25	71	728LS	76
5908VU/2T	457	650H	64	6600 M/253	578	710/OR... - 710/SP...	71	728ME	75
5908VG/2T	486	652	64	6600 M/311	578	720	71	729	76
5910VI/3	447	653	64	6600 M/315	578	720/C12	71	729/15	103
5910VI/3T	448	654	64	6600 M/320	578	720/C24	71	729/16	77
5910VG/3T	487	659/15	64	6600 M/326	578	720/C6	71	729/21	77
5914VU/M	458	659/16	64	6600 M/327	578	720/15	74	729/21L	77
5915VU/0	460	665	65	6600 M/330	578	720/16	74	729/22	77
5915VU/1	460	665LB	66	6600 M/371	578	720/20	74	729/25	77
5915VU/2	461	665SW	66	6600 M/380	579	720/21	74	729/OR... - 729/SP...	77
5915VU/3	461	666HS	296	6600 M/406	579	720/22	74	729L	77
5915VU/4	462	666N	66	6600 M/417	579	720/25	74	729LS	77
5915VU/5	462	666N LBF.IN	67	6600 M/423	579	720/OR... - 720/SP...	74	729T	77

INDEX ALPHANUMÉRIQUE

730	77	7294HM	609	7549N	626	7905G	620	861RIBE	81
730/15	78	7294HMC	609	7549NE	626	7907G	622	861RTX	81
730/21	78	7294HN	609	7549R	626	7907P	622	861SP	81
730/25	78	7310CRK	597	7550G	627	7909B	621	861TX	80
730L	77	7314AF	599	7550N	627	7909G	621	861TQS	81
733/15	78	7315AN	599	7557BL	627	7909P	621	861TRW	81
7041LCD/4S	255	7316NB	600	7575N	622	7909V	621	861TX/C	81
7041LCD/4S-VE	255	7316NG	601	7579QN	622	7930G	617	861XZN	81
7041LCD/4S-VI	255	7317NA	600	7600G	613	7931G	619	862F/A7	557
7042LCD	256	7318AN	600	7600N	613	7933G	620	862F	82
7042LCD/RV	256	7320NA	600	7610G	614	7935G	620	862LP	81
7042LCD/RV-INT	256	7321NA	601	7610N	614	7939G	621	862PH	81
7043	256	7322SA	601	7611G	618	7940	617	862PE	82
7061TC	629	7323SA	601	7635N	624	7949	621	862PH/L	82
7076BC	629	7328A	590	7637G	624	7970	627	862PH-XL	82
7076BD	629	7328N	590	7650	614	7971L	627	862PZ	82
7076BP	629	7340B	607	7650B	614	7978L	627	862TX	82
7076BU	629	7341N	607	7653G	620	7979B	628	862TX/L	82
7093BC	629	7349RP	607	7654B	624	7980N	628	862TX-XL	82
7093BD	629	7350RP	608	7654N	624	7980NC	628	866LP	82
7104 90	628	7352A	602	7657B	624	7980R	628	866PH	82
7105 6	628	7352B	602	7657N	625	7984EG	628	866PZ	82
7109A	629	7352G	602	7658CM	623	7984G	628	866PE	83
7109D	629	7352LG	603	7658N	623	7985	628	866RTX	83
7195A	629	7353Y	603	7659N	623	7996N	628	866TX	83
7200BKK	596	7354N	603	7660B	614			867/...	84
7201BKK	596	7355V	603	7660G	614			867/C20	84
7210BKK	596	7356G	604	7661B	618			867/C38	84
7212B	593	7356LN	604	7661G	618	80	15	867/C52	84
7212G	593	7356V	604	7664G	625	80/S	15	867PE	83
7212LG	593	7357G	604	7664N	625	83	15	867PE/L	83
7213G	594	7357V	605	7665G	625	83/S	15	867RIBE	83
7214FN	594	7362B	605	7665N	625	83AS	16	867RTX	83
7214G	594	7363N	605	7669N	623	83AS/S	16	867RTX/L	83
7214LN	594	7372B	606	7670G	623	88	16	867RIBE/L	84
7215FN	595	7376A	606	7673NG	622	88/S7	16	867TX	83
7216BKK	597	7381N	606	7674NG	623	89BA	308	867TX/L	83
7218FN	595	7382N	606	7780QN	624	89MQ	289	867XZN	83
7218G	595	7398 0/G	610	7800G	628	850MQ	289	867XZN/L	83
7220PEK	591	7398ESD	610	7815CM	618	851	78	882	84
7221PEK	591	7398GEL	610	7818BL	615	851SR	78	882AN	84
7222PEK	591	7398T	610	7818CM	615	852	116	882M	84
7223PEK	592	7398U	610	7818G	615	855P	78	882M1	84
7224PEK	592	7398UP	610	7818LN	616	860/58K	557	882MSR	85
7225PEK	592	7398EF	611	7830SN	616	860/C27	557	882P	85
7235BK	597	7399 A/N...	611	7830ST	616	860/55	79	892	85
7236BK	598	7421	611	7831SN	618	860/58	79	895	85
7238WR	598	7423	611	7831ST	618	860/C38P	80	897	85
7239B	598	7425	611	7840BL	616	860LP	557	897L	85
7241EN	587	7427	611	7849BL	620	860MIX/A10	557	8001Z	634
7241BK	588	7429	611	7860G	616	860MIX/A31	557	8001Z-K	634
7241CK	588	7431P	611	7861G	619	860PE	557	8001TZ	635
7243EN	587	7527	613	7863G	619	860PH	557	8001TZ-K	635
7243BK	588	7528	613	7865G	620	860PZ	557	8002ZD	635
7243CK	589	7529	618	7867G	622	860PE/A10	79	8002ZS	635
7243CR	589	7530	613	7869G	621	860PHZ/A10	79	8003ZD	635
7243FT	589	7545F	625	7880SC	616	860RTX	557	8003ZS	635
7245BK	589	7547AZ	625	7900B	617	860TX	557	8004ND	635
7246E	587	7547BL	625	7900G	617	860TX/A10	557	8004NS	635
7246BK	590	7547G	626	7900P	617	861/C61P	81	8005Z	632
7247BK	590	7547N	626	7900V	617	861LP	80	8005TZ	633
7248GK	598	7547R	626	7901G	619	861PE	80	8005TZ-K	633
7249GK	599	7549AZ	626	7903G	619	861PH	80	8005Z-K	633
7293HM	608	7549BL	626	7903P	619	861PH/C	80	8006Z	633
7293HN	608	7549G	626	7904N	624	861PZ	80	8006Z-K	633
						861PZ/C	80		

INDEX ALPHANUMÉRIQUE

8007Z	633	8060R/PS	656	8146/RKCI	657	8205	658	8600 R/601	582
8007Z-K	633	8061R - 8061F	649	8146/RKFC	657	8206	658	8600 R/611	582
8008N	633	8062	650	8146/RKLL	657	8207	658	8702N	636
8008N-K	633	8063	649	8146/RPC	657	8209	658	8702Z	636
8008TZN	634	8063SL	649	8147C	651	8210	658	8702ZC	636
8009TZ	634	8064S	649	8147S	651	8210F	659	8709N	637
8009TZ-K	634	8065SC	650	8147P	652	8210FTP	659	8709Z	637
8009Z	634	8068S	641	8148	652	8216	659	8709ZC	637
8009Z-K	634	8074	653	8148F	652	8216-K	659	8872	300
8009FD	636	8074A	653	8148/RA	657	8220	659	8872A	300
8009FS	636	8074G	653	8148/RKCL	657	8225	660	8872AS	300
8010TZ	634	8080	653	8148/RKCM	657	8227	660	8873	300
8010Z	634	8080FM	653	8148/RKG	657	8228	660	8877	300
8010Z-K	634	8082	653	8148/RKS	657	8240	660	8877M	300
8015	637	8083	653	8148/RP	657	8240F	660	8879	300
8016	637	8085R	648	8149S/A	651	8242F	660	8880	300
8016FR	637	8086	648	8149	658	8242	661	8883	300
8016FR-K	637	8090R - 8090	648	8149CM	658	8248	659	8889C1	518
8016-K	637	8090F	667	8149CM/RA	658	8249	659	8889C2	518
8016U2	638	8091	644	8150	664	8249G	659	8889C3	518
8016UGK	638	8091SL	644	8153	664	8250	662	8889P1	518
8016U-K	638	8092	644	8156	664	8264	662	8889P2	518
8018E	638	8092SL	645	8157	664	8267	662	8889P3	518
8018T	638	8094	645	8158	664	8272	662	8889C6	519
8020A	638	8094SL	645	8159	665	8273	662	8889CD	519
8021A	638	8096	646	8160	665	8274	661	8889CS	519
8025	639	8096SL	646	8161	665	8274A	661	8889I4	519
8025-K	640	8097	646	8166	667	8274G	661	8889P4	519
8026R	639	8097SL	647	8170	665	8276	661	8889PD	519
8026R-K	639	8098	647	8173	665	8276G	661	8889PS	519
8026A	640	8098SL	647	8176	665	8278	661	9	
8026A-K	640	8100	648	8177	665	8279	663		
8028	640	8105	632	8178	666	8280	662	90	16
8028-K	640	8105-K	632	8179A	666	8282S	662	90/B8N	16
8029R	639	8109	632	8179B	666	8284	662	90/S	16
8029R-K	639	8109-K	632	8179M	666	8285	662	90/SP	16
8031R	639	8110	632	8180	667	8286	663	90AS	16
8031R-K	639	8114	653	8181	667	8287	663	90AS/S	16
8032	639	8116	654	8181S	667	8290	663	90BA	308
8032-K	639	8120	652	8182	668	8293	663	90K	555
8040EN	642	8120B	652	8182A	668	8297C	663	91	17
8040EN-K	642	8120D	652	8182E	668	8297F	663	91BA	308
8040EZ	642	8120DZC	652	8182GD	668	8302Z	636	91HS	295
8040EZ-K	642	8129	653	8182H	668	8303Z	636	91HS-C	295
8041	641	8130	655	8182S	668	8317DZ	654	92	17
8041-K	641	8130A	655	8182T	668	8317SZ	654	92BA	308
8042EN	643	8131DL	655	8182TS	668	8381SL	654	92HS	295
8042EN-K	643	8131Z	655	8182H/2	669	8381SP	654	93	17
8042EZ	643	8135	650	8183	669	8381SX	663	93BA	308
8042EZ-K	643	8135/KCA	656	8184	669	8383C	654	93C	17
8043	642	8135/KGF	656	8185	669	8383P	654	93HS	295
8043-K	642	8135/KGM	656	8186	669	8515V	654	93K	555
8044	643	8135/KLA1	656	8187	670	8515Z	654	94	17
8048	636	8135/KMO	656	8188C	670	8515CH	655	94/S	17
8049	640	8139DL	655	8188CG/25	670	8531	655	94K	555
8049A	641	8139Z	655	8188CU/25	670	8532	655	95	17
8049V	641	8139ZCH	655	8188F	670	8535	655	95/S	17
8050 D	655	8143	650	8188F35	670	8600 R/11	581	95BA	308
8051S	650	8143/RKLL	656	8188VFG2	670	8600 R/12	581	95FTX	17
8051S-K	650	8143/RPC	656	8189	670	8600 R/113	582	95FTX/S	17
8052 - 8055S	649	8143/RKCI	657	8189A	670	8600 R/114	582	96	18
8057R - 8057	649	8143/RPF	657	8189PA	670	8600 R/13	582	96/B	18
8058R - 8058	648	8146	651	8190	669	8600 R/225	582	96/BG7	18
8058R/PS	656	8146C	651	8190B	669	8600 R/412	582	96/BGS7	18
8060R - 8060	648	8146/RK	657	8201T	659	8600 R/511	582	96/SC12	18

INDEX ALPHANUMÉRIQUE

96/SC9	18	97BTXL	23	900FTX/SB9	87	910AN	96	920/25	103
96/ST	18	97BTXL/SC8	23	900FL	88	910A/C10	97	920/35A	103
96/ST6K	555	97RTX	23	900K	557	910A/C16	97	920/36A	103
96AS	19	97RTX/B	23	900L	86	910A/C16Q	97	920/38	103
96AS/B	19	97RTX/SC8	23	900L/SB	86	910A/C16HR	98	920/40	103
96AS/BG7	19	97TTX	23	900LP	87	910A/C17	98	920/42	103
96AS/SC9	19	97TTX/S	23	900M/R55	110	910A/C29	98	920/44	103
96AS/T	19	97TTX/SP	23	900MB	86	910AS/C13	98	920/46	103
96BA	308	97TTXHS	295	900MB/L	86	910AS/MBM-C18	98	920/50	104
96BA/BP	308	97TX	22	900MB/SB	86	910B	93	920/50F	104
96BAF-AS	309	97TX/B	22	900MC	86	910B/SB	93	920/55	104
96BP	20	97TX/BG8	22	900MC/LP	87	910B/SN	94	920/55LC	104
96BP/SC9	20	97TX/G	22	900MC/PH	87	910BL	94	920/55Q	104
96BPC	20	97TX/SC8	22	900MC/TX	88	910BL/SB	94	920/55X	104
96BPC/SC9	20	97TX/ST	22	900ME	88	910BP	95	920/56A	104
96BP-CL	20	98XZN	23	900ME/SB8	88	910BP/SB6L	95	920/58	104
96BP-CL/SC9	20	98XZN/B	23	900M/35	89	910B/C10	97	920/C37	107
96BP/AS	21	99	23	900M/55	90	910B/C16	98	920/R50	111
96BP/ASB	21	99 VN/...	24	900MB/C19	91	910B/C16Q	98	920/R55	111
96BP/AS-SC9	21	99BA	309	900MB/C28	91	910B/C29	98	920/R55LC	111
96BPA	21	99SQ	23	900MC/C24	92	910CF	96	920/R55Q	111
96BPA/SC9	21	99ST	24	900MC/C32	92	910CF/SB	96	920/R55X	111
96BPINOX	302	900	86	900PH	87	910E-HS/56	296	920/55INOX	303
96BPINOX-AS	302	900/R55	110	900PH/SB4	87	910FTX	94	920/R55INOX	303
96BPINOX-AS/B9	302	900/R55-Z	110	900PZ	87	910FTX/SB	94	920/21K	558
96C-AS/SC9	19	900/20LK	557	900PE/AS	88	910FTX/L	95	920/25K	558
96C/AS	19	900/25K	558	900PT	88	910FTX/LSB	95	920/55K	558
96INOXBP/B	302	900/55K	558	900TX	88	910FTX/XL	95	920/58K	558
96L	20	900/55ZK	558	900TX/SB	88	910FTX-XL/C10	95	920A/AS	100
96L/SC12	20	900/58K	558	900T/44	89	910LP	95	920A-AS/SB11	100
96L/SP8	20	900/SB	86	900U	87	910M/R55	111	920AS	100
96LBP	20	900/...	88	900U/SB	87	910MQ/21	289	920AS/L	100
96LBP/SC9	20	900/16	88	900U/C12M	92	910MQ/22	289	920AS/SB11	100
96LC	19	900/25	88	902A/C22	93	910MQ/B	289	920ASL/SB11	100
96LC/SC12	20	900/32	89	902R/C6	93	910MQ/PE	289	920AN	103
96LC/SC8	20	900/35A	89	910/R55	111	910MQ/PT	289	920A/C11	105
96N	18	900/40	89	910/R55Q	111	910MQ/TX	289	920A/C12	105
96N/B	19	900/42	89	910/R55X	111	910MQ/XZN	289	920A/C12X	105
96N/G	19	900/55	89	910/21K	558	910MQ/55	290	920A/C20	105
96N/SC12	19	900/55Z	89	910/25K	558	910MQ/C16	290	920A/C20Q	105
96N/SC9	19	900/58	90	910/55K	558	910MQ/T	290	920A/C20X	105
96N/ST	19	900/C11	90	910/58K	558	910ME	95	920A/C21	106
96N/ST6K	555	900/C11Z	90	910/15	96	910ME/SB	95	920A/C21X	106
96T	21	900/C12MR	90	910/16	96	910M/35	96	920A/C33	106
96T/AS	21	900/C39N	90	910/20 - 910/21 -	96	910M/55	97	920A/C17M	107
96T/S11	21	900/C39U	90	910/22	96	910M/56	97	920A/C17MR	107
96T/S6	21	900/C12MZ	91	910/25	96	910PE	95	920AS/C10	107
96T/SP	21	900/C13-5	91	910/36A	97	910PE/AS	95	920AS/C15	107
96T/SPV	520	900/C13-8	91	910/40	97	910PE/SB	95	920AS/C17X	107
96TAS/S	21	900/C24	91	910/42	97	910PH	95	920AS/MBM-C21	107
96TBP	22	900/C11HR	93	910/46	97	910PH/SB4	95	920A/C17HR	108
96TBP/S6	22	900AS	86	910/55	97	910PT	96	920AK	558
96TBP-HS	295	900AS/MB	86	910/55Q	97	910PT/SB	96	920A	99
96THS	295	900AS/SB11	86	910/58	97	910TX	96	920A/SB13	99
96THS-AS	295	900AS/L	87	910AK	558	910TX/SB	96	920A/SB8	99
96TINOX	303	900AS/MBL	87	910A	93	910XZN	96	920AL	99
96TINOX/S6	303	900AN	88	910A/SB	93	911BA	309	920AL/SB11	99
96TINOX-AS	303	900AS/C10	92	910AL	93	911BA/16	309	920BP	101
96TINOX-AS/S8	303	900AS/C17-MBM	92	910AL/SB14	93	911BA/20	309	920BP/SB	101
96TK	556	900AS/MB-C17	92	910A/AS	94	911BA/55	309	920B/C11	105
97BTX	22	900BG/30K	558	910A-AS/SB13	94	914MQ/A	290	920B/C12	105
97BTX/B	22	900BG/30	89	910AS	94	914MQ-A/S4	290	920B/C12X	105
97BTX/SC8	22	900BG/30C	89	910AS/L	94	920/15	103	920B/C20	105
97BTX-C	22	900E-HS/56	296	910AS/SB13	94	920/16	103	920B/C20X	106
97BTX-C/SC8	22	900FTX	87	910AS/SN	94	920/20+920/23	103	920B/C21	106
				910ASL/SB12	94				

INDEX ALPHANUMÉRIQUE

920B/C21X	106	921BA/50	310	944BX/D	114	960PI/S	122	991	126
920B/C30Q	106	921BA/R50	310	944BX/S	114	960PMC	122	992	126
920B/C33	106	921BA-AS	310	944BX/DG	570	960RPI	122	993	126
920B	99	926BA	310	949	114	960S	119	993G	127
920B/SB13	99	926BA/15	310	949/S6	114	960SL	119	993MQ	291
920B/SB8	99	926BA/22	310	950	114	960SN	119	993PL	126
920BL	99	926BA/42	310	950/S	114	960T/A	119	994	127
920BL/SB11	99	926BA/50	311	951	115	960T/B	119	994MQ	291
920ES	102	926BA/R50	311	951/S	115	960T/C11	119	994PL	127
920ES/SB	102	928.../C12	109	951/SP	115	960T/C	120	994TF	127
920ES/XL-SB	102	928/15	109	951AS	115	960T/D	120	996	127
920E-HS/55LC	296	928/16	109	951AS/S	115	960T/E	120	998	127
920FTX	100	928/20 - 928/21 -	109	951BA	311	960T/F	120	999	127
920FTX/C	100	928/22		951K	559	960T/G	120	999/B6N	127
920FTX/L	100	928/25	109	951MQ	291	960T/H	120	999A	127
920FTX/LSB	100	928/36A	109	951TX	115	960T/I	120	999B	127
920FTX/SB	100	928/42	109	951TX/S	115	960T/L	120	999C	127
920INOX-A	303	928/55	109	952	116	960T/M	120	999D	127
920LH/SB7	101	928/R55	111	952/S	116	960UC	122	999E	127
920LP	101	928/R55X	111	952AS	116	960VTC	122	999G	127
920ME	101	928A	108	952FTX	116	960YP	121	9500TL	672
920ME/SB	101	928AS	108	952FTX/S	117	961BA	311	9501TL	672
920ME/C	102	928AS/C12	109	952L	116	961P6	123	9501TLD	672
920M/35	103	928B	108	953	117	961P6/S	123	9502TL	673
920M/35L	103	928B/C12	109	953/S	117	962	123	9503TL	673
920M/55	104	928ME	108	953TX	117	962C	123	9504TL	673
920M/56	104	929	109	953TX/S	117	962M	123	9505TL	673
920MC/C14	105	929/15	110	955	117	962P	123	9508TL	673
920M/R55	111	929/21 - 929/22	110	956C	117	963	123	9510W	673
920MQ/21	290	929/42	110	956E	117	963BA	311	9515M	676
920MQ/22	290	929/55	110	956F	117	964	123	9516B	676
920MQ/55A	290	929/55PR	110	956L	118	964BA	311	9521	676
920MQ/A	290	929/C8	110	957	118	964BA/L	311	9521OB	676
920MQ/PE	290	929/R55	111	959	118	965	123	9522A	681
920MQ/T	290	930	111	959R	118	965/S	123	9523T	678
920MQ/C16	291	930/C	111	960	118	965BA	311	9523A	681
920MC	99	930/S	111	960/22EP	120	966/C3	123	9524SC	678
920PE	101	932	112	960/C6	120	966BA	311	9525/B	675
920PE/AS	101	932/S	112	960/D	120	966BA/V	311	9525F	675
920PE/C	101	932HS	296	960A	118	969/C5	124	9525TL	675
920PE/SB	101	933	112	960AVE	121	969B	124	9526P	681
920PE-AS/SB6	101	933/S	112	960AVL	122	970B	124	9526RMN	681
920PH	101	935	112	960AD/TP2	177	970IVECO	124	9527 6T	681
920PH/SB4	101	935/S	112	960BC	118	971/C8	124	9527MUG	681
920RTX	102	935K	558	960BC/C5	118	972/C10	124	9528B	678
920RTX/SB	102	937	112	960BC/P 28	118	972/C4BMW	124	9534WO	673
920TX	102	937/S	112	960BT/B	118	973	124	9534BO	674
920TX/C	102	937BA	311	960CMB	121	978 - 979	124	9537TL	674
920TX/L-SB4	102	937K	558	960CMB/R2	121	982	125	9539CB	676
920TX/SB	102	940	112	960CMD	121	983 PM/R-DA	125	9541BIKE	675
920TX/C17	108	941	113	960CMD/R1	121	983PM	125	9541F	675
920U	100	941/S	113	960ER	119	984	125	9541PC	675
920U/SB13	100	942BX	113	960EPC	121	985/B7	125	9541S	675
920U/SB4	100	942BX/S	113	960EPC/L	121	985F	125	9542M	676
920U/C17M	108	942BX/DG	570	960E-PI/P	121	985M	125	9542AL	677
920XZN	102	943BX	113	960F	119	986 48	125	9542AT	677
920XZN/LS	102	943BX/D	113	960G	119	986 78	125	9542C	677
920XZN/SB12	102	943BX/S	113	960H/C4	119	986PT	125	9542G	677
920XZN/SB7	102	943BXK	559	960KC-M8/M9/M10	121	987	125	9542GW	677
921BA	310	943BX/DG	570	960KPC	122	987AR	126	9542S	677
921BA/15	310	943FL	113	960L	119	987P	126	9543C	677
921BA/16	310	943FL/S	113	960M	119	988/K4	126	9544C	674
921BA/21 - 921BA/22	310	943MQ	291	960P	122	989	126	9547T	678
921BA/25	310	943MQ/S	291	960PI	122	989A	126	9547WSK	678
921BA/42	310	943MQ/BG	570	960PI/C19	122	989B	126	9547	681
		944BX	114			990	126		

INDEX ALPHANUMÉRIQUE

9548G	678	9597P	678	C11 - 2111	349	C45PRO M7	432	C55M4	410
9548KB	678	9598WHP-N	676	C12 - 2112	349	C45PRO M7A/W	429	C55M7	410
9548KB 20	678	9598W-N	676	C13	349	C45PRO M7A/X	429	C55M8	411
9548KB 24	678	9599 GARAGE	673	C14	349	C45PRO M8	433	C55MA	412
9549ABW	680	9599CB-N2	676	C16 - 2116	350	C45PRO MA	434	C55MDO	412
9549BP	680	9599CB-W	676	C18 - 2118	350	C45PRO ML	434	C55MP	418
9549CR	680	9711 - LUBRIBETA	524	C19 - 2119 - C19L - 2119L	351	C45PRO MS	433	C55MS	413
9549MPC	680	universal				C45PRO MWS/W	430	C55P/2MDX-SX	414
9549SBW	680	9713 - Ultra Sblock	524	C20 - C20L - 2120	351	C45PRO MWS/X	429	C55P/MCD	414
9549BRW	681	9721 - Multi Grease	524	C20TSS	304	C45PRO PAS	436	C55PB/3	401
9549C	681	9723 - Lithium Grease	524	C22B	351	C45PRO PF	436	C55PFA-0,8	416
9557J 2.0	675	9725 - PTFE Grease	525	C22P	351	C45PRO PFE	437	C55PFA-1,0	414
9557N	675	9727 - Copper Grease	525	C22W	351	C45PRO PM	438	C55PM	414
9559	679	9730 - Silic Spray	525	C25	368	C45PRO PML	438	C55PM/M0,8	416
9559/30MT	679	9739 - Cutting Oil	525	C27S	369	C45PRO RD	433	C55PRO B/2	402
9561V	679	9741 - Brake Cleaner	525	C30M	371	C45PRO SL	436	C55PRO B/2,8	403
9561V 2,5	679	9742 - Multi Cleaner	525	C35/6GM	372	C45PRO SS	436	C55PRO B-D4	404
9561VV	679	9743 - Contact Cleaner	525	C35/7GM	373	C45PRO T3	435	C55PS	417
9561VV 2,5	679	9744 - Surface Cleaner	525	C35/8GM	373	C45PRO TC	435	C55PSE	417
9562T1	278	9746 - Carb Cleaner	525	C35/9GM	373	C45PRO W	424	C55PT0,8x0,6	416
9562T3	278	9747 - Clima Cleaner	526	C37/6	375	C45PRO X	423	C55PT1,0x0,6	415
9562T2	397	9750 - Air Spray	526	C37/7	374	C45PW/1-0,7MT	430	C55PTE-0,8	416
9562TB	630	9753 - Zinc 98%	526	C37/8	375	C45PW/2-1,3MT	430	C55PTE-1,0	415
9562P12	683	9756 - Welding Spray	526	C37A/7	375	C45PW/3-2,0MT	431	C55RB	407
9562P2	683	9766 - De-icer Spray	526	C38	377	C45PX/1-0,7MT	430	C55STR	422
9563G	680	9801L	522	C38C	378	C45PX/2-1,3MT	430	C55T3	413
9563U	680	9802M	522	C38L	377	C45PX/3-2,0MT	431	C56	394
9565S	630	9803H	522	C38L A	377	C45STR	439	C56B	394
9565BBQ	679	9811L	522	C38T	378	C48M	386	C56M	395
9565T	679	9812M	522	C39/6	380	C48P	386	C56P O	389
9565ICE	680	9813H	522	C39/7	379	C51	387	C56PL O	389
9565K	680	9821L	523	C39/8	380	C54S	390	C56W	394
9569MS	682	9822M	523	C39MD	382	C55	400	C57SA	391
9569MS-2	682	9823H	523	C39SM	382	C55/1PF	416	C57SB	392
9569P	682	9831L	523	C39T	380	C55/2PM	415	C57SC	392
9569S	682	9832M	523	C41H	383	C55/PF	414	C57SD	391
9572LB	673	9833H	523	C41H/CE	383	C55/PL-1,024	407	C57SP	393
9574B	675	9833M	523	C41S	383	C55A1	420	C57SP	393
9574O	675	9832M	523	C42H	384	C55A1/R42	420	C58B	395
9577R	679	9841N	524	C45LMP	440	C55A2	421	C58M	395
9579C	679	9841R	524	C45PRO ACT	435	C55A2/R70	421	C58M/PA	396
9580S	674	9852	524	C45PRO AS1	439	C55AB	401	C58P	393
9586K	681	9881U	264	C45PRO AS2	439	C55AC	418	C59A	396
9587 13x21	682	9882R	264	C45PRO AW	424	C55AE	417	C59B	397
9587 9x14	682	9899 CV/A	110	C45PRO AX	424	C55AT1	422	C59C	397
9588M	682	9899 CV/B	110	C45PRO BPW-1,3	428	C55AT2	422	C62M/W	629
9588S/10...	682	9899 CV/C	110	C45PRO BPW-2,0	428	C55B PT/2	407	C64/1	629
9588/10PI	683			C45PRO BPX-1,3	427	C55B PT/2,8	407	C64CW	630
9589A/36	683			C45PRO BPX-2,0	428	C55B/1	419	C64G/1	630
9589B/36	683			C45PRO BW	425	C55B/2	402	C68	574
9590B	679			C45PRO BX	425	C55B/2,8	403	C68 G	574
9592B/C50	681			C45PRO C5	431	C55B/G	405	C68N	574
9592B/P	681			C45PRO C7	431	C55B/GAA	405	C88 R/1	574
9592M/50	681			C45PRO CAI/W	438	C55B/GAE	406	C88NR/1	574
9592MB	681			C45PRO CAI/X	438	C55B/GDP	405	C88SE	574
9593A	674			C45PRO CORNER/W	437	C55B/GDS	405	C88VE	574
9593M	674			C45PRO CORNER/X	437	C55B/GES	406	C99	352
9593S	674			C45PRO CW	427	C55B/VS	407	C99C-V3	355
9593SB	674			C45PRO CX	427	C55B-D4	404	C99M	356
9593W	674			C45PRO DW	426	C55C	419	C99P	355
9594	681			C45PRO DX	425	C55C7	408	C99P12-V0	353
9595 C25	682			C45PRO EW	426	C55C8	409	C99PC	356
9595C	682			C45PRO EX	426	C55CS	411	C99PP	356
9595T	682			C45PRO M3A	434	C55KAI	418	C99P-V3	356
9596	682			C45PRO M4	432	C55KAS	418	C99T	356
				C45PRO M5	432	C55M2	409	C99T-V3	356
								C99V0	352

INDEX ALPHANUMÉRIQUE

C99V0-P12	353	M125	498	MC20	504	T45	509	T201	515
C99V1	354	M126	499	MC21	504	T46	509	T202	515
C99V2	354	M127	499	MM105	506	T48	509	T204	515
C99V3/2C	355	M128	499	MM11	506	T50	509	T205	515
CA49-G	385	M129	499	MM140	507	T52	509	T206	515
CB/2	520	M133	499	MM210	507	T53	509	T207	515
CB52	388	M134	499	MM400	507	T55	509	T208	515
CD23S	358	M135	499	MM401	507	T57	510	T209	515
CP	440	M136	499	MM61	506	T59	510	T211	515
CP15 - 2115	349	M137	499	MM63	506	T63	510	T213	515
CP15L - 2115	350	M145	499	P		T64	510	T216	515
CP17 - CP17L - 2117	350	M153	500			T65	510	T221	516
CP51	388	M161	500	PM 1/2-Q5	102	T68	510	T226	516
CX49-G	385	M162	500	PM/5C	440	T73	510	T227	516
G, K		M166	500	PM/6C	440	T75	510	T228	516
GM	519	M170	500	PV	393	T76	510	T231	516
KIT/GPS	519	M172	500	R		T77	510	T233	516
M		M174	500			T79	510	T234	516
M01	494	M180	500	RSC22	357	T80	511	T236	516
M02	494	M195	500	RSC23	358	T81	511	T239	516
M05	494	M201	501	RSC23C	358	T82	511	T241	516
M06	494	M204	501	RSC23T	359	T83	511	T250	516
M13	494	M208	501	RSC24/5	361	T85	511	T256	516
M25	494	M209	501	RSC24/6	361	T91	511	T259	517
M30	494	M213	501	RSC24/7	360	T92	511	T264	517
M31	494	M214	501	RSC24/8	361	T99	511	T270	517
M33	494	M216	501	RSC24A/6	362	T100	511	T273	517
M38	494	M217	501	RSC24A/7	362	T101	511	T281	517
M39	495	M218	501	RSC24A/8	362	T102	511	T284	517
M40	495	M219	501	RSC24AXL/7	363	T103	512	T285	517
M44	495	M222	501	RSC24AXL/8	364	T105	512	T289	517
M45	495	M226	501	RSC24AXL/9	364	T106	512	T291	517
M46	495	M227	502	RSC24L/7	367	T111	512	T297	518
M49	495	M230	502	RSC24L-CAB	367	T112	512	TSP	519
M50	495	M231	502	RSC28	370	T113	512	V	
M52	495	M234	502	RSC51	387	T121	512	VE1	519
M53	495	M236	502	S		T122	512	VP1 - VP2	518
M55	495	M237	502	S42/17	520	T123	512	VP3 - VP4	518
M60	496	M240	502	S55/12	519	T124	512	VP5	518
M62	496	M264	503	S55/8	519	T135	512	VP6	518
M63	496	M284	503	S96T/8	520	T136	513	VP-3SC	518
M65	496	M285	503	S951/6	520	T137	513	VP-LD	518
M67	496	M289	503	S952/10	520	T138	513	VP-LS	518
M69	496	M292	503	S1719BM	520	T140	513	VPM	507
M75	496	M295	503	SB	519	T144	513	VPM0	507
M78	496	M305	503	SGN	520	T145	513	VPM3	507
M79	496	M310	503	SPC	440	T146	513	VPM7	507
M82	496	M400	519	SPG11 - S1203/8	520	T151	513	VPM7-C	507
M83	497	M401	503	ST2P	519	T153	513	VPM8	507
M85	497	MB	504	T		T156	513	VPM9	507
M86	497	MB12	504			T157	513		
M91	497	MB37	504	T01	508	T160	513		
M92	497	MB38	504	T05	508	T161	513		
M94	497	MB39	504	T06	508	T164	513		
M96	497	MB44	505	T13	508	T167	514		
M100	497	MB45	505	T18	508	T168	514		
M105	498	MB46	505	T19	508	T170	514		
M108	498	MB47	505	T22	508	T171	514		
M110	498	MB56	505	T23	508	T172	514		
M112	498	MB58	505	T31	509	T173	514		
M115	498	MB59	505	T33	509	T175	514		
M120	498	MB63	506	T34	509	T176	514		
M121	498	MB64	506	T40	509	T177	514		
		MC10	504	T41	509	T180	514		
		MC12	504			T183	514		
						T198	514		
						T199	515		

NUMÉROS CLÉS DU GROUPE BETA

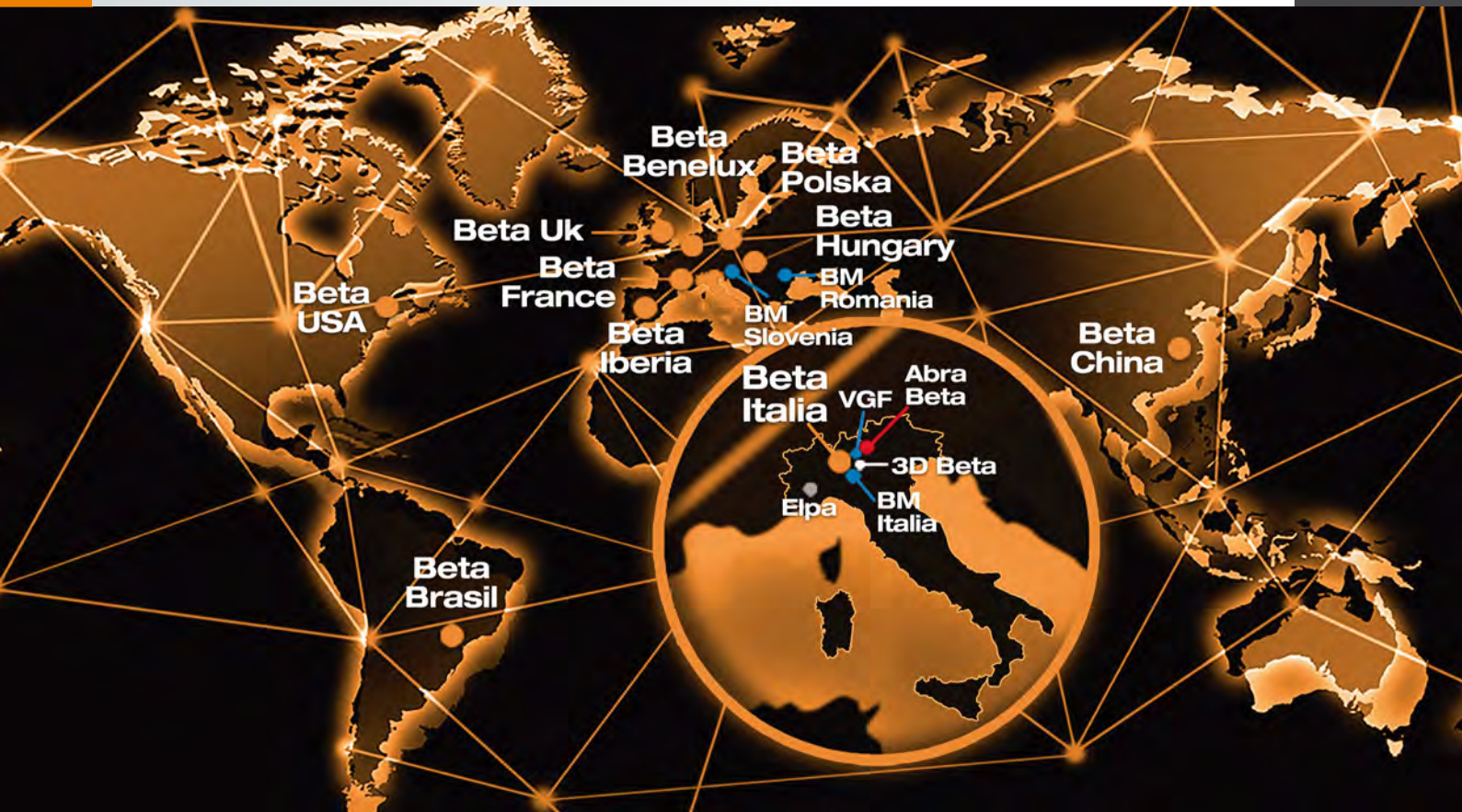

8 unités
de production
EN ITALIE



Environ **900**
employés

BETA UTENSILI S.p.A. - 20845 Sovico (MB)
Via A. Volta, 18 - Tel. 039.2077.1 - Fax 039.2010742
www.beta-tools.com

11 Filiales
dans le monde

Présent dans plus
de **100 pays** à
travers le monde
avec plus de **250**
importateurs



Robur Wire rope accessories:
67039 Sulmona (AQ) Zona industriale - C.da S. Nicola
Tel. 0864.2504.1 - Fax 0864.253132
www.roburitaly.com - info@roburitaly.com

L'HISTOIRE DE L'OUTILLAGE EN ITALIE

- 1923** ● Alessandro Ciceri fonde l'usine pour la fabrication de moules en fer et en acier "Alessandro Ciceri & Figli" à Erba (CO).
- 1939** ● La marque Beta est créée et l'entreprise se spécialise dans la production d'outils à usage professionnel, fabriqués dans l'usine de Sovico (MB), et qui est encore à ce jour le siège de l'entreprise.
- 1960** ● Beta Utensili compte 200 employés, s'impose en Italie comme une réalité émergente dans le secteur de l'outillage professionnel et exporte ses produits à l'étranger.
- 1969** ● Le chariot révolutionnaire "Tank" en tôle orange est conçu. Dès cet instant, la couleur orange dénote le style incomparable de Beta.
- 1971** ● Beta Utensili entre dans le monde de la course automobile, d'abord en Formule 1, puis dans les courses de rallye et enfin dans le monde du sport automobile.
- 1973** ● Inauguration de l'usine de Castiglione d'Adda (LO), qui s'ajoute à celle historique de Sovico (MB).
- 1975** ● Le premier grand succès en Formule 1 arrive avec la March orange Beta Utensili de Vittorio Brambilla, vainqueur du Grand Prix d'Autriche, à Zeltweg, en plein déluge.
- 1980** ● L'expansion sur les plus importants marchés européens se poursuit avec l'implantation progressive de filiales Beta Utensili en France, en Grande-Bretagne, aux Pays-Bas, en Espagne, en Pologne et en Hongrie.
- 1984** ● Inauguration de la troisième usine de l'entreprise à Sulmona (AQ) où sont forgées les emblématiques clés mixtes 42 et où les accessoires de levage de la marque Robur sont produits et testés.
- 1995** ● En 8 mois seulement, l'entreprise obtient la certification du système de qualité ISO 9001.
- 2000** ● La présentation du nouveau catalogue Beta Utensili confirme le processus de croissance continue. La gamme de produits double et plus de 10.000 références sont réparties en 22 familles de produits.
- 2002** ● L'offre Beta Utensili ne cesse de se développer avec l'introduction d'une gamme de chaussures de sécurité et d'une ligne de vêtements de travail et de loisirs "Beta Work".
- 2009** ● Beta augmente sa présence sur de nouveaux marchés en ouvrant la nouvelle filiale Beta China.
- 2012** ● Ouverture de la filiale Beta Brazil.
- 2016** ● Beta présente le nouveau système modulaire pour mobilier d'atelier RSC55.
- 2018** ● Le processus de consolidation du Groupe Beta commence avec l'acquisition de BM S.p.A., leader dans la production et la commercialisation de cosses de câbles et de systèmes de connexion électrique. Les acquisitions de 3D Beta S.r.l., société spécialisée dans la conception et la production de systèmes d'ameublement sur mesure et VGF S.r.l., spécialiste du vernissage à base de poudres de mobilier en métal. La stratégie de croissance du Groupe se poursuit avec les acquisitions d'Abra Beta S.p.A. et d'Elpa Abrasivi S.r.l., leader dans la production d'abrasifs, élargissant ainsi son offre de produits professionnels.
- 2020** ● Beta Tools USA est créé, une étape importante dans la stratégie d'expansion sur le marché nord-américain.
- 2023** ● Une croissance continue qui atteint à ce jour, avec une gamme qui compte 30 familles de produits et plus de 16.000 références et créées pour répondre aux besoins des professionnels afin de garantir une qualité et des performances constantes dans le temps, selon le principe « Beta Well Done », car pour Beta, il n'y a qu'une seule façon de faire bien les choses.



1923 Alessandro Ciceri & Figli



1939 Département forge



1955 Département découpage

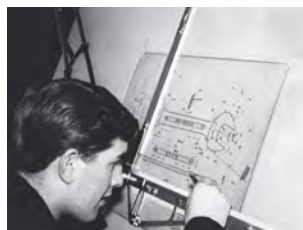

1960 Conception



1969 Chariot Tank



1974 Publicité assortiments



1975 Vittorio Brambilla



2002 "BetaWork"

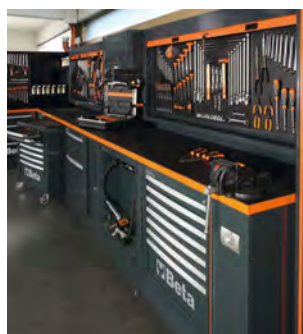

2016 Mobilier d'atelier RSC55

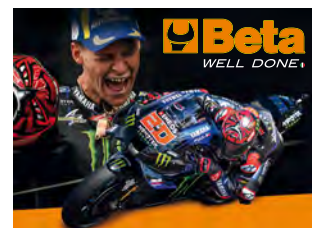

2022 Fabio Quartararo, Ambassadeur Beta

QUALITÉ CERTIFIÉE

Depuis 2018, les servantes Beta portent la prestigieuse marque Tüv, remportée à l'issue de tests sévères de la procédure de contrôle EK5/TA5.

La procédure EK5/TA5 prévoit 31 caractéristiques de construction bien définies, des tests statiques rigoureux et des tests de réaction dynamique. D'autres tests définissent la résistance aux températures élevées et basses, la durée des marquages dans le temps et la résistance à la corrosion.

L'obtention de ces résultats récompense la conception experte, la réalisation minutieuse et les contrôles sévères que Beta met en place tout au long du processus de production des servantes et qui ont assuré l'appréciation des utilisateurs finaux.



CONTRÔLE ET QUALITÉ

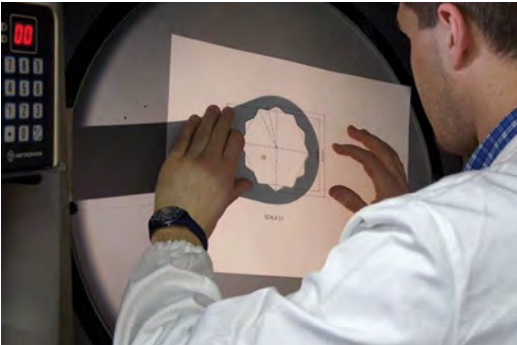
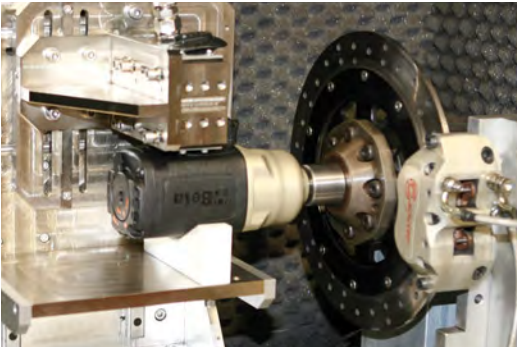
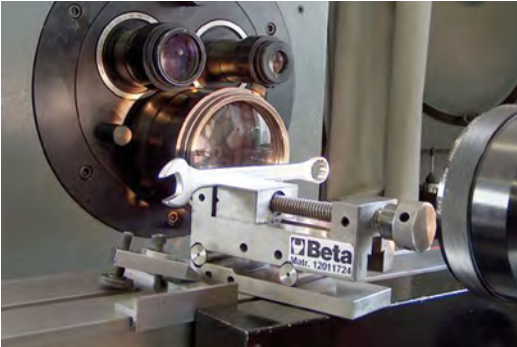

Chez Beta, la qualité a un sens simple et concret : « ce qui répond pleinement aux exigences et attentes de l'utilisateur professionnel pour qui nos produits son un outil fondamental pour leur travail ». L'outil n'est pas seulement conçu et construit correctement pour remplir sa fonction, mais il assure également la répétition des performances d'une manière homogène dans le temps.

La qualité Beta ne s'exprime pas seulement par une politique industrielle et commerciale attentive, mais elle va plus loin avec l'implication de chaque division de l'entreprise dans la même direction pour atteindre des objectifs toujours plus ambitieux en termes de satisfaction de la clientèle. C'est sur ce concept que Beta a construit son histoire.

**Qualité Beta,
l'aspect le plus
concret**

**La qualité des outils
Beta est la synthèse
de techniques anciennes
et de nouvelles
technologies.**



Depuis 1995, les processus de production sont certifiés conformes aux standards du Système Qualité ISO 9001



LOGISTIQUE



**22.000 m²
de superficie**



16.000
références gérées
et plus de **27.000**
unités de charge



**Livraisons
rapides, précises
et complètes**



ORGANISER LE TRAVAIL

5S est une méthode d'organisation de la zone de travail d'origine japonaise.

Cette méthode prend son nom de la transcription occidentale de 5 mots japonais: seiri, seiton, seiso, seiketsu et shitsuke.

En suivant les 5 passages identifiés par ces mots, on obtient une méthode systématique et renouvelable pour l'optimisation des normes professionnelles et l'amélioration des résultats du fonctionnement.



SEIRI

SÉLECTIONNER

Éliminer tout ce qui est superflu de la zone de travail et garder uniquement les outils strictement nécessaires.



SEITON

SYSTÉMATISER

Créer le rangement : chaque chose à sa place et une place pour chaque chose.



SEISO

SYSTÈME

Nettoyer l'espace de travail et le garder en ordre dans le temps.



SEIKETSU

STANDARDISER

Définir des méthodes répétitives pour continuer à rationaliser les ressources et les espaces en définissant des règles standardisées à suivre.



SHITSUKE

SOUTENIR

Soutenir et diffuser cette façon de penser et d'agir dans toutes les activités de la société.



AVANTAGES



Gain de temps et réduction des coûts



Amélioration de la qualité et de la productivité



Réduction des accidents du travail



Augmentation de l'efficacité



AVANT



APRÈS

PRÉSENCE EFFICACE

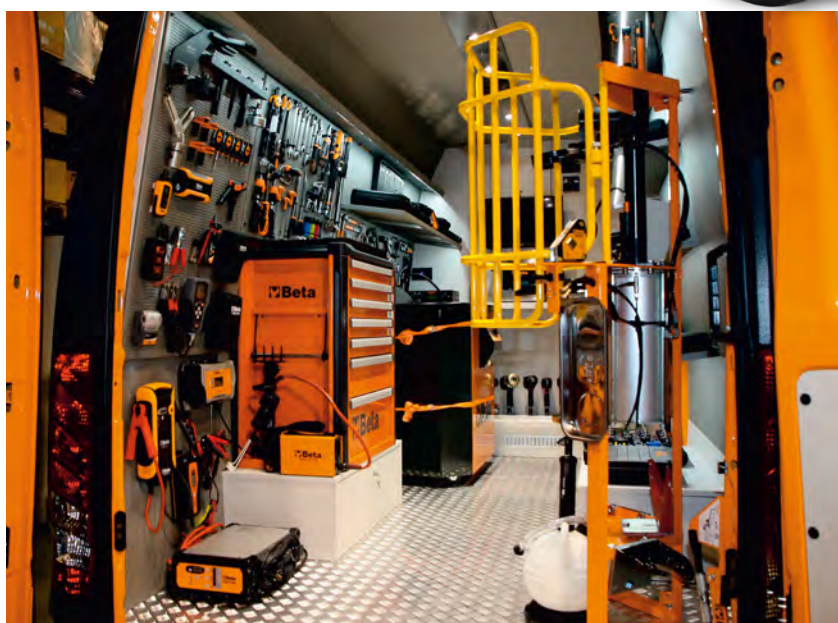
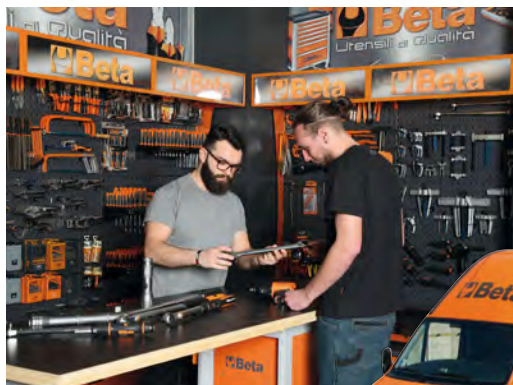

**Unité de
démonstration
2022**

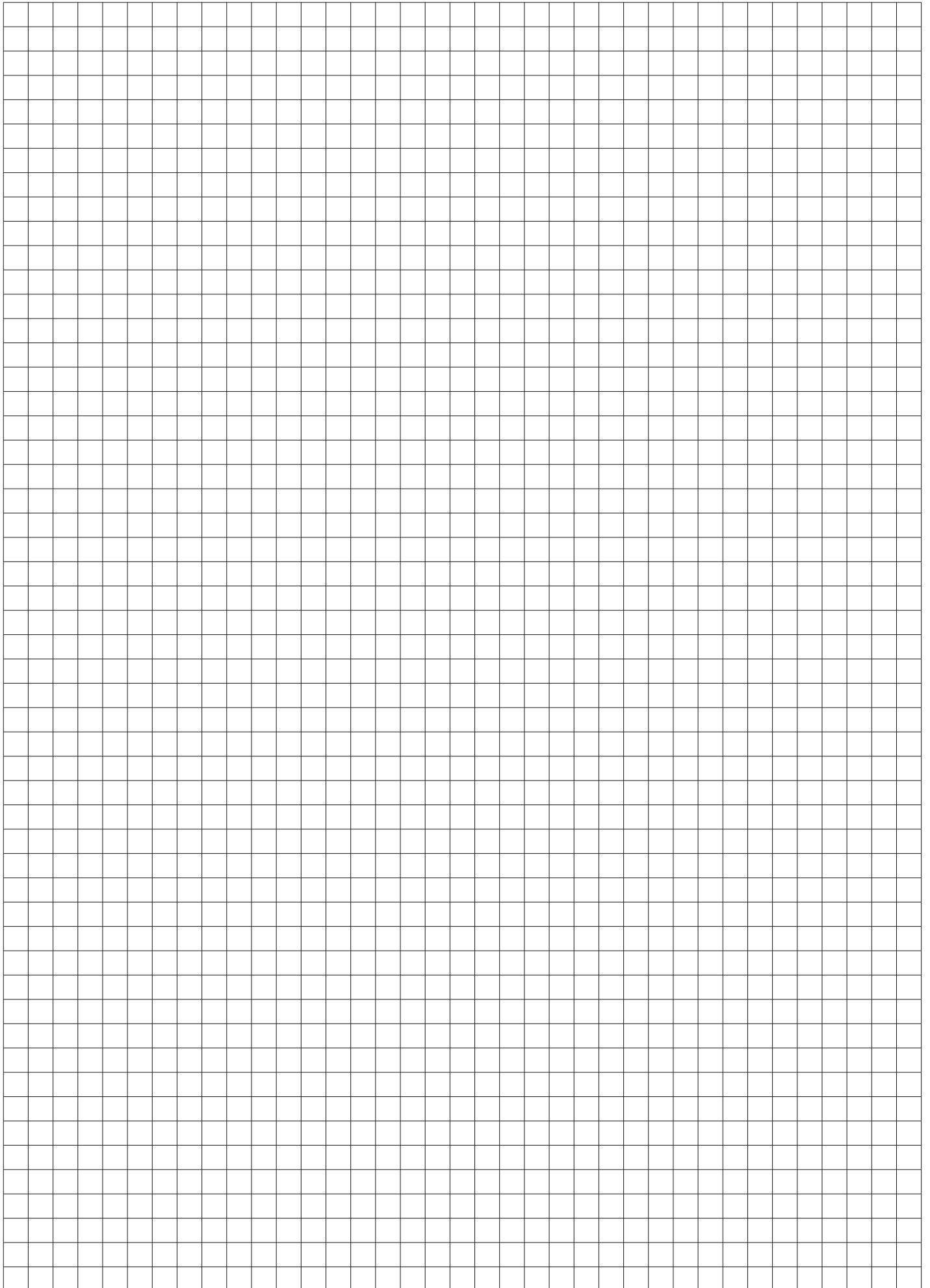

Fabio Quartararo
2022 MotoGP
World Championship



YAMAHA
OFFICIAL SPONSOR
MotoGP Team 2022

Partnership 2022

 **Beta**

50 Years in Motorsports

PARTNERSHIP

2022



TEAM
speedup

ALONSO LOPEZ
Moto2 World
Championship



Technical
Partner



Beta | **aprilia**
RACING



998069102

